



Department of Administration  
 Purchasing Division  
 2019 Washington Street East  
 Post Office Box 50130  
 Charleston, WV 25305-0130

**State of West Virginia  
 Solicitation Response**

**Proc Folder:** 1299978  
**Solicitation Description:** Addendum 1-Asphalt Mat, Delivery & Labor by Vendor by County  
**Proc Type:** Agency Master Agreement

Solicitation Closes	Solicitation Response	Version
2023-10-31 14:30	SR 0803 ESR10302300000002098	1

**VENDOR**  
 000000203375  
 KELLY PAVING INC

**Solicitation Number:** ARFQ 0803 DOT2400000028  
**Total Bid:** 0  
**Response Date:** 2023-10-31  
**Response Time:** 09:32:45  
**Comments:**

**FOR INFORMATION CONTACT THE BUYER**

Jerry D Rush  
 304-414-6683  
 jerry.d.rush@wv.gov

**Vendor Signature X** **FEIN#** **DATE**

All offers subject to all terms and conditions contained in this solicitation

Line	Comm Ln Desc	Qty	Unit Issue	Unit Price	Ln Total Or Contract Amount
1	Asphalt Materials, Delivery & Labor by Vendor by County	0.00000	TON	0.000000	0.00

Comm Code	Manufacturer	Specification	Model #
30121600			

**Commodity Line Comments:**

**Extended Description:**

Vendor shall use the ATT A (Pricing Pages) for providing its actual Bid. Vendors Note: Do NOT enter prices on commodity lines in OASIS.

Line	Comm Ln Desc	Qty	Unit Issue	Unit Price	Ln Total Or Contract Amount
2	Mobilization	0.00000	MILE	0.000000	0.00

Comm Code	Manufacturer	Specification	Model #
24000000			

**Commodity Line Comments:**

**Extended Description:**

Vendor shall use the ATT B (Pricing Pages) for providing its actual Bid. Vendors Note: Do NOT enter prices on commodity lines in OASIS.



State of West Virginia  
Agency Request for Quote  
Highways

Proc Folder: 1299978			Reason for Modification:
Doc Description: Addendum 1-Asphalt Mat, Delivery & Labor by Vendor by County			Addendum 1
Proc Type: Agency Master Agreement			
Date Issued	Solicitation Closes	Solicitation No	Version
2023-10-23	2023-10-31 14:30	ARFQ 0803 DOT2400000028	2

**BID RECEIVING LOCATION**

BUDGET & PROCUREMENT  
DIVISION OF HIGHWAYS  
BLDG 5, RM A-317  
1900 KANAWHA BLVD E  
CHARLESTON WV 25305  
US

**VENDOR**

Vendor Customer Code:  
Vendor Name : Kelly Paving, Inc.  
Address : P.O. Box 66  
Street : 1731 Old SR7  
City : Rayland  
State : Ohio Country : US Zip : 43943  
Principal Contact : Rita Lantz (740)859-2104  
Vendor Contact Phone: Megan Temple (740)391-5918 Extension:

**FOR INFORMATION CONTACT THE BUYER**  
Jerry D Rush  
304-414-6683  
jerry.d.rush@wv.gov

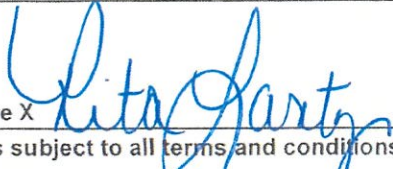
Vendor Signature X  FEIN# 55-0583614 DATE 10-31-2023

All offers subject to all terms and conditions contained in this solicitation

**ADDITIONAL INFORMATION**

Addendum 1 is issued for the following reasons:

- 1.To attach revised specifications.
- 2.To attach vendor questions and Agency responses.
- 3.To attach revised ATT A, ATT B, ATT C, and ATT D.
- 4.To attach Exhibit 5 and Exhibit 6.
- 5.To revised bid closing time to 2:30 P.M. on 10/31/2023.

No other changes

INVOICE TO	SHIP TO
------------	---------

VARIOUS AGENCY  
LOCATIONS  
AS INDICATED BY ORDER

VARIOUS AGENCY  
LOCATIONS  
AS INDICATED BY ORDER

No City                      WV  
US

No City                      WV  
US

Line	Comm Ln Desc	Qty	Unit Issue	Unit Price	Total Price
1	Asphalt Materials, Delivery & Labor by Vendor by County	0.00000	TON		

Comm Code	Manufacturer	Specification	Model #
30121600			

**Extended Description:**

Vendor shall use the ATT A (Pricing Pages) for providing its actual Bid. Vendors Note: Do NOT enter prices on commodity lines in OASIS.



INVOICE TO	SHIP TO
------------	---------

VARIOUS AGENCY  
LOCATIONS  
AS INDICATED BY ORDER

VARIOUS AGENCY  
LOCATIONS  
AS INDICATED BY ORDER

No City                      WV  
US

No City                      WV  
US

Line	Comm Ln Desc	Qty	Unit Issue	Unit Price	Total Price
2	Mobilization	0.00000	MILE		

Comm Code	Manufacturer	Specification	Model #
24000000			

**Extended Description:**

Vendor shall use the ATT B (Pricing Pages) for providing its actual Bid. Vendors Note: Do NOT enter prices on commodity lines in OASIS.

SCHEDULE OF EVENTS
--------------------

<u>Line</u>	<u>Event</u>	<u>Event Date</u>
1	TECHNICAL QUESTION DEADLINE 10:00 A.M.	2023-10-20

**SOLICITATION NUMBER:** ARFQ DOT2400000028

**Addendum Number:** 1

---

The purpose of this addendum is to modify the solicitation identified as (“Solicitation”) to reflect the change(s) identified and described below.

**Applicable Addendum Category:**

- Modify bid opening date and time
- Modify specifications of product or service being sought
- Attachment of vendor questions and responses
- Attachment of pre-bid sign-in sheet
- Correction of error
- Other

**Description of Modification to Solicitation:**

Addendum 1 is issued for the following reason:

- 1.To attach revised specifications.
- 2.To attach vendor questions and Agency responses.
- 3.To attach revised ATT A, ATT B, ATT C, and ATT D.
- 4.To attach Exhibit 5 and Exhibit 6.
- 5.To revised bid closing time to 2:30 P.M. on 10/31/2023.

No other changes

**Additional Documentation:** Documentation related to this Addendum (if any) has been included herewith as Attachment A and is specifically incorporated herein by reference. ✚

**Terms and Conditions:**

1. All provisions of the Solicitation and other addenda not modified herein shall remain in full force and effect.
2. Vendor should acknowledge receipt of all addenda issued for this Solicitation by completing an Addendum Acknowledgment, a copy of which is included herewith. Failure to acknowledge addenda may result in bid disqualification. The addendum acknowledgement should be submitted with the bid to expedite document processing.

# ATTACHMENT A

Solicitation Number #ARFQ DOT2400000028

Responses to Questions from Vendors

**Question 1**

Is it the intention that the State utilize the October price index for Asphalt and Fuel as the Baseline index for these contracts. I'm inquiring since the November information will likely be available since the contract closes on Oct 31st, however since the contract is closing in October I assume the State would likely utilize the October one as the baseline.

**Answer 1**

Per Section 4.2 in the Contract Specifications, "The bidding index for asphalt and fuel will be listed on the Contract Administration website for Fuel, Asphalt and Cement Prices Adjustments listed for October 2023. Contract Base Price at time of bid will be based on October 2023."

**Question 2**

There is a missing document for the VRAM bid item in the contracts. Exhibit 6 – SP403 Void Reducing Asphalt Membrane

**Answer 2**

Thank you for bringing this to our attention. Exhibits 5 and 6 were left off the uploaded solicitation. They have been included with this addendum.

**Question 3**

For the haul rate... everything is bid by the ton-mile correct? There is no loaded-ton-mile bid items this year.

**Answer 3**

All haul contract items available for bid are bid by the ton mile unit of measure.

**Question 4**

Regarding Contract Item #96 VRAM: Please consider tearing this item (Linear Footage) much like the Laydown Items #28 - #31 are. If not, please consider a minimum Linear Footage of 2000'.

**Answer 4**

We have added additional Contract Items 96 through 99, with varying Linear Foot ranges. The Contract Specifications, ATT A, and ATT B have been updated to reflect the Contract Item additions and renumbering.

#### **Question 5**

When performing J-Band/VRAM, Traffic Control, Clean & Sweep, and Striking or Marking the Center-Line must be performed. Should these be bid as incidental to item #96? Or will Traffic Control and Clean and Sweep be considered and built into the design quantities when the Design Engineer is designing the project?

#### **Answer 5**

Traffic Control shall be per section 3.2.26 of the Contract Specifications.

Contract Item 100 has been added to address the potential need for centerline removal, and Contract Specifications section 3.2.25 has been revised to the following:

**Void Reducing Asphalt Membrane, Contract Items 96 -99**, shall be in accordance with **Exhibit 6 – SP403 Void Reducing Asphalt Membrane**, as amended. All surface preparation shall be included in the VRAM bid price except when the center line must be removed, then **VRAM Preparation, Removal of Center Line, Contract Item 100**, may be charged; no additional mobilizations shall apply.

#### **Question 6**

Regarding Contract Item #96 VRAM.

#### **Answer 6**

Please see answer #2 Above regarding Exhibit 6.

**WEST VIRGINIA DEPARTMENT OF TRANSPORTATION**

**DIVISION OF HIGHWAYS**

**SPECIAL PROVISION**

**FOR**

**STATEWIDE ASPHALT MATERIALS, DELIVERY**

**& LABOR BY VENDOR BY COUNTY**

**CONTRACT 6624C018, EXHIBIT 5**

**SECTION 498**

**ULTRA-THIN ASPHALT OVERLAY**

**498.1 – DESCRIPTION:**

This Special Provision covers the materials, equipment, construction, and application procedures for placing Ultra-Thin Asphalt Overlays on existing paved surfaces. Ultra-Thin, as described in this Special Provision shall be defined as a single lift ranging from 5/8" (70 psy) to 3/4" (85 psy).

**498.2 – MATERIALS:**

The mixture components of the asphalt mixture shall conform to the following requirements:

**498.2.1 – Tack Coat:** The Tack Coat shall conform to the requirements of Section 408.2.

**498.2.2 - Performance Graded Binders:** The PG Binders shall conform to Section 705.5. The binder grade shall be noted on the typical section of the plans.

**498.2.3 - Fine Aggregate:** The fine aggregate used shall meet the requirements of ASTM D1073, except that the gradation requirements will be waived. In addition, aggregates used for surface courses on projects with an ADT greater than 3000 shall be from an approved source identified as having polish-resistant aggregates and considered potential skid-resistant aggregate sources.

**498.2.3.1 – Sand Equivalency - (ASTM D2419):** The Sand Equivalency value of the fine aggregate shall be 60 minimum.

**498.2.3.2 – Soundness - (MP 700.00.22):** When subjected to five cycles of the Sodium Sulfate test, the weighted percentage of loss shall not exceed twelve (12%).

**498.2.3.3 – Fine Aggregate Angularity - (AASHTO T304):** When using Method A, the Fine Aggregate blend shall have a Minimum uncompacted void content of 43%.

**498.2.4 – Coarse Aggregate:** If coarse aggregate is used, it shall meet the requirements of Sections 703.1 through 703.3, with the exception that the total shale, coal and other lightweight deleterious material and friable particles shall not exceed 3%. In addition, aggregates used for surface courses on projects with an ADT greater than 3000 shall be from an approved source identified as having polish-resistant aggregates and considered potential skid-resistant aggregate sources. No more than 50% of the coarse aggregate shall be Dolomite.

**498.3 – ASPHALT MIXTURE:**

**498.3.1 – Job Mix Formula:** A Job Mix Formula (JMF) shall be developed in accordance with MP 401.02.22 procedurally, but the asphalt mixture shall conform to the requirements detailed in the following Tables. The asphalt mixture shall be identified as Wearing- III – Heavy on the T-400 Form. The asphalt mixture shall be produced at a WVDOH approved plant.

**Table 498.3.1.1 – Ultra-Thin Asphalt Overlay Mixture Marshall Design Requirements**

Test Property	Design Criteria (Marshall)
Compactive Effort (# of blows – each end of specimen)	75 Blows
Percent Air Voids	4.0 %
Percent VMA	17.0 % - Minimum
Percent VFA	73 – 80
Stability (Newtons)	10,000 - Minimum
Flow (0.25 mm)	7 – 16
Fines to Asphalt Ratio	0.5 – 1.0

**Table 498.3.1.2 – Ultra-Thin Asphalt Overlay Mixture Design Gradation Requirements**

Sieve Size	Total Percent Passing by Weight
1 / 2 Inch	100
3 / 8 Inch	96 – 100
No. 4	70 – 95
No. 8	40 – 65
No. 16	20 – 45
No. 30	15 – 30
No. 50	8 – 20
No. 200	3.0 – 8.0

**498.4 – CONSTRUCTION:**

**498.4.1 – Tack Coat:** The Tack Coat shall be applied uniformly, completely covering the entire prepared surface, at an application rate of 0.03 – 0.05 gallon/square yard undiluted or 0.06 – 0.10 gallon/square yard diluted, regardless of existing surface. All requirements of Sections 408.3 through 408.10 shall be followed.

**498.4.2 – Asphalt Overlay Placement:** The asphalt overlay shall be produced, placed and compacted in accordance with Sections 401.9 and 401.10. It shall be placed at the application rate stated in the plans, which shall be within the rates noted in Section 498.1. Application rate shall be checked at a maximum interval of 2500 feet.

Due to the rapid cooling rate of the asphalt mixture at this application rate range, the weather restrictions as stated in Section 401.8 shall be strictly enforced. The paving operation shall be paced as to not outrun the rollers. The following number of rollers shall be required:

Average Laydown Rate (Tons / Hour)	Compaction Rollers Required	Finish Rollers Required
Less than 75	1	1
75 - 150	2	1

**498.5 – TESTING:**

The standard test methods as outlined in Section 401.5.1 shall be followed.

**498.5.1 – Contractor’s Quality Control:** Contractor shall follow the requirements of Section 401.6 for Quality Control Testing except that samples for determination of mix properties shall be obtained at intervals of 250 tons production.. The tolerances shown in Table 498.5.1.1 below shall be used for production, and be applied for basis of payment as per Section 498.7.

**Table 498.5.1.1**

**Ultra-Thin Asphalt Overlay Production Tolerances for Quality Control and Acceptance**

Parameter	Range from JMF
Air Voids <sup>1</sup>	± 1.5
Binder Content <sup>2</sup>	± 0.40
% Passing ½” Sieve	0
% Passing 3/8” Sieve	± 2.0
% Passing # 8 Sieve	± 5.0
% Passing # 30 Sieve	± 4.0
% Passing # 200 Sieve	± 1.5

<sup>1</sup> The limits for air voids shall apply to Quality Control testing only

<sup>2</sup> The asphalt binder content shall be determined by the ignition oven method.

**498.5.2 – Acceptance Testing:** Acceptance testing is the responsibility of the Division.



**498.5.3 – Compaction Testing:** Since the nuclear gauge does not accurately read densities at this specified lift thickness and the asphalt will cool rapidly, the compaction shall consist of making six (6) roller passes. A roller pass is one complete coverage over the material. The compaction needs to be completed before the mat temperature reaches 175° F.

**498.5.4 – Quality Control and Verification Testing:** The Contractor shall designate a person to monitor and document the number of passes and the mat temperature through the duration of the Project. This person shall be certified as WVDOH Asphalt Field and Compaction Technician.

**498.6 – METHOD OF MEASUREMENT:**

**498.6.1 – Tack Coat:** The tack coat shall be measured in accordance to Section 408.12.

**498.6.2 – Asphalt Overlay:** Depending on the items specified in Section 498.8, the asphalt overlay shall be either measured by the square yard as placed or shall be measured in accordance to Section 401.12.

**498.7 – BASIS OF PAYMENT:**

**498.7.1 – Tack Coat:** The tack coat shall be paid in accordance to Section 408.13.

**498.7.2 – Ultrathin Asphalt Overlay:** The completed work shall be paid for based on the measurements obtained as per Section 498.6.2 and paid at the contract unit price per the items shown in Section 498.8. Based on the results of testing performed as per 498.5, the following price adjustment schedule will be used when appropriate and applied accordingly to representative material:

- (i) One percent reduction in the bid price per square yard for each one-tenth percent the asphalt content is out of tolerance.
- (ii) One-quarter percent price adjustment in the bid price per square yard for each one percent that the aggregate gradation is out of the job mix range on each sieve
- (iii) One and a half percent reduction in the bid price per square yard for application rate dropping below the plan rate by more than 2 lb/sq yd. Reduction shall apply to each increment of 1lb/sq yd thereafter. If the application rate drops below the plan rate by more than 5 lb/sq yd, the material will not be accepted and measures will need to be taken by the contractor to correct for such deficiency

Price adjustments under 1, 2, and 3 above shall apply concurrently; however, price adjustment will not apply in the event the material is rejected. The disposition of rejected material will be subject to the approval of the Engineer

**498.8 – PAY ITEMS:**

ITEM	DESCRIPTION	UNIT
498000-001	Ultrathin Asphalt Overlay	Square Yard (SY)
498001-001	Ultrathin Asphalt Overlay	Ton (TN)

**WEST VIRGINIA DEPARTMENT OF TRANSPORTATION**

**DIVISION OF HIGHWAYS**

**SPECIAL PROVISION**

**FOR**

**STATEWIDE ASPHALT MATERIALS, DELIVERY**

**& LABOR BY VENDOR BY COUNTY**

**CONTRACT 6624C018, EXHIBIT 6**

**SECTION 403**

**VOID REDUCING ASPHALT MEMBRANE**

**403.1-DESCRIPTION:**

This work consists of furnishing and installing Void Reducing Asphalt Membrane (VRAM) material ahead of construction of longitudinal construction joints in asphalt concrete surface courses.

**403.2-MATERIALS:**

The material shall be a base asphalt modified with styrene-butadiene diblock or triblock copolymer without oil extension, or styrene-butadiene rubber elastomers. It shall not use air blown asphalt, acid modification, or other modifiers. VRAM material shall meet the requirements of table 403.2 below.

**TABLE 403.2 VRAM MATERIAL REQUIREMENTS**

<b>Test</b>	<b>Test Requirement</b>	<b>Test Method</b>
Dynamic shear @ 88°C (unaged), G*/sin δ, kPa	1.00 min.	AASHTO T 315
Creep stiffness @ -18°C (unaged), Est Stiffness (S), MPa m-value	300 max. 0.300 min.	AASHTO T 313
Ash, %	1.0 to 4.0	AASHTO T 111
Elastic Recovery, (unaged) 10 cm elongation, hold 5 minutes before cutting, 25°C, Report to nearest 0.1%	70 min.	ASTM D6084 Method A
Separation of Polymer, Difference in °C of the softening point (ring and ball apparatus)	3 max.	ASTM D7173, AASHTO T53

**403.3-EQUIPMENT:**

**403.3.1-Distributor:** When a pressure distributor is used to apply VRAM, the distributor shall be equipped with a heating and recirculating system along with a functioning auger agitating system or vertical shaft mixer in the hauling tank to prevent localized overheating.

**403.3.2-Melter:** When a melter kettle is used to transport and apply VRAM, only oil-jacketed, double-boiler melter kettles with agitating and recirculating systems shall be used. Material from the kettle may be dispensed through a pressure feed wand with an applicator shoe or through a pressure feed wand into a hand-operated “thermal push cart.”

**403.4-CONSTRUCTION:**

**403.4.1-Surface Preparation:** Prior to placing VRAM, the pavement surface area to be treated shall be cleaned of all foreign material. VRAM shall be applied only to surfaces that are dry and cleaned of all dust, debris, and any substances that will prevent adhesion. VRAM may be placed before or after the tack coat placement, however, tack coat shall not be placed on top of VRAM material. When placing after the tack coat, the tack coat must be fully cured prior to placement of the VRAM.

**403.4.2-Weather Requirements:** VRAM shall be applied only when the pavement surface temperature and the ambient temperature are a minimum of 40 °F and rising.

**403.4.3-Application:** VRAM shall be applied at the application rate and width listed in Table 403.4.3.

When the VRAM material will not be exposed to traffic, the Contractor shall coordinate the application of VRAM and placement of the asphalt mixture to ensure the center of the VRAM application is within  $\pm 2.0$  inches of the center of the cold longitudinal joint being constructed.

When traffic is to be maintained across the VRAM material, the Contractor shall apply VRAM material on the cold longitudinal construction joint such that 60 percent of the specified band width is placed on the side of the joint that will be paved first. The contractor shall not open to traffic if width of exposed VRAM material is greater than 6 inches.

If the paving operation allows VRAM to be placed on only one side of the cold longitudinal joint at a time and it is not exposed to traffic, the Contractor shall place 50 percent of the required width and application rate prior to paving the first pass. Prior to closing the cold longitudinal joint with the final pass, the Contractor shall place the remainder of the VRAM material and coat the cold joint’s vertical face with VRAM material. The total amount of VRAM material applied shall meet the application rate listed in Table 403.4.3.

If the work includes constructing only one side of a cold longitudinal joint; such as adjacent to pavement to remain in place, or against curb, or curb and gutter; the Contractor shall construct the VRAM using one-half the width and one-half the application rate listed in Table 403.4.3.

The VRAM, meeting the requirements specified herein, shall be applied to the existing surface at the width and target application rate as specified in the following table:

**TABLE 403.4.3 VRAM APPLICATION RATES**

<b>Coarse-Graded HMA Mixtures</b> <small>Note 1</small>		
<b>Overlay Thickness, in</b>	<b>VRAM Width, in.</b>	<b>Application Rate, lb/ft</b>
1	18	1.15
1 ¼	18	1.31
1 ½	18	1.47
1 ¾	18	1.63
≥ 2	18	1.80
<b>Fine-Graded HMA Mixtures</b> <small>Note 1</small>		
<b>Overlay Thickness, in</b>	<b>VRAM Width, in.</b>	<b>Application Rate, lb/ft</b>
1	18	0.80
1 ¼	18	0.88
≥ 1 ½	18	0.95

Note 1 - Refer to Table 4 of MP 401.02.28 for definitions of coarse and fine graded mixes

Ensure the applied width of VRAM is within  $\pm 1.5$  inches of the width specified. If the VRAM flows more than 2 inches from the initial placement width, the Contractor shall immediately stop placement and perform corrective actions.

When beginning placement of a run of VRAM, the Contractor shall use a suitable release paper to cover previous VRAM application to prevent doubling up of thickness of VRAM.

The contractor shall ensure the VRAM is suitable for construction traffic to drive on without pickup or tracking within 30 minutes of placement. If pickup or tracking occurs, immediately stop placement of VRAM and repair damaged areas.

**403.4.4-Paving:** Prior to start of paving, the Contractor shall ensure the paver end plate and any grade control devices are adequately raised above the finished height of the VRAM. The contractor shall immediately cease placement of asphalt mixture and VRAM if flushing is noted in the asphalt surface and shall not continue placement of the asphalt mixture until the issue is corrected.

#### **403.5-ACCEPTANCE:**

The Contractor shall furnish a bill of lading for each tanker supplying material to the project. The Contractor shall verify the application rate of VRAM within the first 1,000 feet of the day's scheduled application length and every 6,000 feet the remainder of the day. For projects less than 3000 feet, the rate will be verified once.

Verification shall be done by placing suitable paper or a pan of known weight at a random location in the path of the VRAM placement. After VRAM application, pick up the paper or pan and obtain the weight of material. Calculate the weight per foot of VRAM. Ensure the actual weight per foot of VRAM is within  $\pm 15$  percent of the target application rate from Table 403.4.3. Application rate verification shall be provided to the Engineer. Replace VRAM in the areas where the samples are taken.

**403.6-METHOD OF MEASUREMENT:**

The quantity of work done will be measured in linear feet of VRAM completed and accepted in place.

**403.7-BASIS OF PAYMENT:**

The quantity of work, as determined above, will be paid for at the contract unit price bid for the item below, which price and payment shall be full compensation for furnishing all materials, and doing all the work prescribed in a workmanlike and acceptable manner, including all the labor, tools, equipment, supplies and incidental necessary to complete the work.

**403.8-PAY ITEM:**

<b>ITEM</b>	<b>DESCRIPTION</b>	<b>UNIT</b>
403005-001	Void Reducing Asphalt Membrane	Linear Foot

ADDENDUM ACKNOWLEDGEMENT FORM  
SOLICITATION NO.: ARFQ DOT240000028

Instructions: Please acknowledge receipt of all addenda issued with this solicitation by completing this addendum acknowledgment form. Check the box next to each addendum received and sign below. Failure to acknowledge addenda may result in bid disqualification.

Acknowledgment: I hereby acknowledge receipt of the following addenda and have made the necessary revisions to my proposal, plans and/or specification. etc.

Addendum Numbers Received:

*(Check the box next to each addendum received)*

- |  |  |
|--|--|
| <input checked="" type="checkbox"/> Addendum No. 1 | <input type="checkbox"/> Addendum No. 6  |
| <input type="checkbox"/> Addendum No. 2            | <input type="checkbox"/> Addendum No. 7  |
| <input type="checkbox"/> Addendum No. 3            | <input type="checkbox"/> Addendum No. 8  |
| <input type="checkbox"/> Addendum No. 4            | <input type="checkbox"/> Addendum No. 9  |
| <input type="checkbox"/> Addendum No. 5            | <input type="checkbox"/> Addendum No. 10 |

I understand that failure to confirm the receipt of addenda may be cause for rejection of this bid. I further understand that any verbal representation made or assumed to be made during any oral discussion held between Vendor's representatives and any state personnel is not binding. Only the information issued in writing and added to the specifications by an official addendum is binding.

Kelly Paving, Inc.  
\_\_\_\_\_  
Company  
  
\_\_\_\_\_  
Authorized Signature  
10-31-2024  
\_\_\_\_\_  
Date

NOTE: This addendum acknowledgement should be submitted with the bid to expedite document processing.

**INSTRUCTIONS TO VENDORS SUBMITTING BIDS**  
**(Agency Delegated Procurements Only)**

**1. REVIEW DOCUMENTS THOROUGHLY:** The attached documents contain a solicitation for bids. Please read these instructions and all documents attached in their entirety. These instructions provide critical information about requirements that if overlooked could lead to disqualification of a Vendor's bid. All bids must be submitted in accordance with the provisions contained in these instructions and the Solicitation. Failure to do so may result in disqualification of Vendor's bid.

**2. MANDATORY TERMS:** The Solicitation may contain mandatory provisions identified by the use of the words "must," "will," and "shall." Failure to comply with a mandatory term in the Solicitation will result in bid disqualification.

**2A. PREBID MEETING:** The item identified below shall apply to this Solicitation.

A pre-bid meeting will not be held prior to bid opening

A MANDATORY PRE-BID meeting will be held at the following place and time:

All Vendors submitting a bid must attend the mandatory pre-bid meeting. Failure to attend the mandatory pre-bid meeting shall result in disqualification of the Vendor's bid. No one individual is permitted to represent more than one vendor at the pre-bid meeting. Any individual that does attempt to represent two or more vendors will be required to select one vendor to which the individual's attendance will be attributed. The vendors not selected will be deemed to have not attended the pre-bid meeting unless another individual attended on their behalf. The required attribution of attendance to a single vendor should be addressed during the pre-bid but may occur at any time deemed appropriate by the Purchasing Division.

An attendance sheet provided at the pre-bid meeting shall serve as the official document verifying attendance. Any person attending the pre-bid meeting on behalf of a Vendor must list on the attendance sheet his or her name and the name of the Vendor he or she is representing.

Additionally, the person attending the pre-bid meeting should include the Vendor's E-Mail address, phone number, and Fax number on the attendance sheet. It is the Vendor's responsibility to locate the attendance sheet and provide the required information. Failure to complete the attendance sheet as required may result in disqualification of Vendor's bid.

All Vendors should arrive prior to the starting time for the pre-bid. Vendors who arrive after the starting time but prior to the end of the pre-bid will be permitted to sign in, but are charged with knowing all matters discussed at the pre-bid.

Questions submitted at least five business days prior to a scheduled pre-bid will be discussed at the pre-bid meeting if possible. Any discussions or answers to questions at the pre-bid meeting are preliminary in nature and are non-binding. Official and binding answers to questions will be published in a written addendum to the Solicitation prior to bid opening.

**3. VENDOR QUESTION DEADLINE:** Vendors may submit questions relating to this Solicitation to the Agency Contact. Questions must be submitted in writing. All questions must be submitted on or before the date listed below and to the address listed below to be considered. A written response will be published in a Solicitation addendum if a response is possible and appropriate. Non-written discussions, conversations, or questions and answers regarding this Solicitation are preliminary in nature and are nonbinding.

Submitted emails should have the solicitation number in the subject line.

Question Submission Deadline: 10/20/2023 at 10:00 A.M.

Submit Questions to:  
Jerry Rush

Email: [dotprocurementtechques@wv.gov](mailto:dotprocurementtechques@wv.gov)

**4. BID SUBMISSION:** All bids must be submitted electronically through *wv*OASIS or signed and delivered by the Vendor to the Agency on or before the date and time of the bid opening. Any bid received by the Agency staff is considered to be in the possession of the Agency and will not be returned for any reason.

#### **4A. BID SUBMISSION**

A bid that is not submitted electronically through *wv*OASIS should contain the information listed below on the face of the envelope or the bid may be rejected by the Agency.

SEALED BID: Asphalt Materials, Delivery & Labor by Vendor by County

BUYER: Jerry Rush

SOLICITATION NO.: ARFQ DOT2400000028

BID OPENING DATE: 10/31/2023

BID OPENING TIME: 1:30 P.M

FAX NUMBER: 304-558-0047

**5. ADDENDUM ACKNOWLEDGEMENT:** Changes or revisions to this Solicitation will be made by an official addendum issued by the Agency. Vendor should acknowledge receipt of all addenda issued with this Solicitation by completing an Addendum Acknowledgment Form, a copy of which is included herewith. Failure to acknowledge addenda may result in bid disqualification. The addendum acknowledgement should be submitted with the bid to expedite document processing.



**6. BID FORMATTING:** Vendor should type or electronically enter the information onto its bid to prevent errors in the evaluation. Failure to type or electronically enter the information may result in bid disqualification.

**7. ALTERNATE MODEL OR BRAND:** Unless the box below is checked, any model, brand, or specification listed in this Solicitation establishes the acceptable level of quality only and is not intended to reflect a preference for, or in any way favor, a particular brand or vendor. Vendors may bid alternates to a listed model or brand provided that the alternate is at least equal to the model or brand and complies with the required specifications. The equality of any alternate being bid shall be determined by the State at its sole discretion. Any Vendor bidding an alternate model or brand should clearly identify the alternate items in its bid and should include manufacturer's specifications, industry literature, and/or any other relevant documentation demonstrating the equality of the alternate items. Failure to provide information for alternate items may be grounds for rejection of a Vendor's bid.

This Solicitation is based upon a standardized commodity established under West Virginia Code § 5A-3-61. Vendors are expected to bid the standardized commodity identified. Failure to bid the standardized commodity will result in your firm's bid being rejected.

**8. EXCEPTIONS AND CLARIFICATIONS:** The Solicitation contains the specifications that shall form the basis of a contractual agreement. Vendor shall clearly mark any exceptions, clarifications, or other proposed modifications in its bid. Exceptions to, clarifications of, or modifications of a requirement or term and condition of the Solicitation may result in bid disqualification.

**9. REGISTRATION:** Prior to Contract award, the apparent successful Vendor must be properly registered with the West Virginia Purchasing Division and must have paid the \$125 fee, if applicable.

**10. UNIT PRICE:** Unit prices shall prevail in cases of a discrepancy in the Vendor's bid.

**11. PREFERENCE:** Vendor Preference may be requested in purchases of motor vehicles or construction and maintenance equipment and machinery used in highway and other infrastructure projects. Any request for preference must be submitted in writing with the bid, must specifically identify the preference requested with reference to the applicable subsection of West Virginia Code § 5A-3-37, and must include with the bid any information necessary to evaluate and confirm the applicability of the requested preference. A request form to help facilitate the request can be found at: <http://www.state.wv.us/admin/purchase/vrc/Venpref.pdf>.

**11A. RECIPROCAL PREFERENCE:** The State of West Virginia applies a reciprocal preference to all solicitations for commodities and printing in accordance with W. Va. Code § 5A-3-37(b). In effect, if reciprocal preference is requested by a West Virginia resident vendor, non-resident vendors receiving a preference in their home states, will see that same preference granted to West Virginia resident vendors bidding against them in West Virginia. Any request for reciprocal preference must include with the bid any information necessary to evaluate and confirm the applicability of the preference. A request form to help facilitate the request can be found at: <http://www.state.wv.us/admin/purchase/vrc/Venpref.pdf>.

**12. SMALL, WOMEN-OWNED, OR MINORITY-OWNED BUSINESSES:** For any solicitations publicly advertised for bid, in accordance with West Virginia Code §5A-3-37 and W. Va. CSR § 148-22-9, any non-resident vendor certified as a small, women-owned, or minority-owned business under W. Va. CSR § 148-22-9 shall be provided the same preference made available to any resident vendor. Any non-resident small, women-owned, or minority-owned business must identify itself as such in writing, must submit that writing to the Purchasing Division with its bid, and must be properly certified under W. Va. CSR § 148-22-9 prior to contract award to receive the preferences made available to resident vendors. Preference for a non-resident small, women-owned, or minority owned business shall be applied in accordance with W. Va. CSR § 148-22-9.

**13. ELECTRONIC FILE ACCESS RESTRICTIONS:** Vendor must ensure that its submission in *wvOASIS* can be accessed and viewed by the Agency staff immediately upon bid opening. The Agency will consider any file that cannot be immediately access and viewed at the time of the bid opening (such as, encrypted files, password protected files, or incompatible files) to be blank or incomplete as context requires, and therefore unacceptable. A vendor will not be permitted to unencrypt files, remove password protections, or resubmit documents after bid opening to make a file viewable if those documents are required with the bid. A Vendor may be required to provide document passwords or removed access restrictions to allow the Agency to print or electronically save documents provided that those documents are viewable by the Agency prior to obtaining the password or removing the access restriction.

**14. NON-RESPONSIBLE:** The Purchasing Division Director reserves the right to reject the bid of any vendor as Non-Responsible in accordance with W. Va. Code of State Rules § 148-1-5.3, when the Director determines that the vendor submitting the bid does not have the capability to fully perform, or lacks the integrity and reliability to assure good-faith performance.”

**15. ACCEPTANCE/REJECTION:** The State may accept or reject any bid in whole, or in part in accordance with W. Va. Code of State Rules § 148-1-4.5. and § 148-1-6.4.b.”

**16. YOUR SUBMISSION IS A PUBLIC DOCUMENT:** Vendor’s entire response to the Solicitation and the resulting Contract are public documents. As public documents, they will be disclosed to the public following the bid/proposal opening or award of the contract, as required by the competitive bidding laws of West Virginia Code §§ 5A-3-1 et seq., 5-22-1 et seq., 5G-1-1 et seq. and the Freedom of Information Act in West Virginia Code §§ 29B-1-1 et seq.

**DO NOT SUBMIT MATERIAL YOU CONSIDER TO BE CONFIDENTIAL, A TRADE SECRET, OR OTHERWISE NOT SUBJECT TO PUBLIC DISCLOSURE.**

Submission of any bid, proposal, or other document to the Purchasing Division constitutes your explicit consent to the subsequent public disclosure of the bid, proposal, or document. The Purchasing Division will disclose any document labeled “confidential,” “proprietary,” “trade secret,” “private,” or labeled with any other claim against public disclosure of the documents, to include any “trade secrets” as defined by West Virginia Code § 47-22-1 et seq. All submissions are subject to public disclosure without notice.

**GENERAL TERMS AND CONDITIONS:  
(Agency Delegated Procurements Only)**

**1. CONTRACTUAL AGREEMENT:** Issuance of an Award Document signed by the Agency and approved as to form by the Attorney General's office, if required, constitutes acceptance by the State of this Contract made by and between the State of West Virginia and the Vendor. Vendor's signature on its bid, or on the Contract if the Contract is not the result of a bid solicitation, signifies Vendor's agreement to be bound by and accept the terms and conditions contained in this Contract.

**2. DEFINITIONS:** As used in this Solicitation/Contract, the following terms shall have the meanings attributed to them below. Additional definitions may be found in the specifications included with this Solicitation/Contract.

**2.1. "Agency" or "Agencies"** means the agency, board, commission, or other entity of the State of West Virginia that is identified on the first page of the Solicitation or any other public entity seeking to procure goods or services under this Contract.

**2.2. "Bid" or "Proposal"** means the vendors submitted response to this solicitation.

**2.3. "Contract"** means the binding agreement that is entered into between the State and the Vendor to provide the goods or services requested in the Solicitation.

**2.4. "Director"** means the Director of the West Virginia Department of Administration, Purchasing Division.

**2.5. "Purchasing Division"** means the West Virginia Department of Administration, Purchasing Division.

**2.6. "Award Document"** means the document signed by the Agency that identifies the Vendor as the contract holder.

**2.7. "Solicitation"** means the official notice of an opportunity to supply the State with goods or services.

**2.8. "State"** means the State of West Virginia and/or any of its agencies, commissions, boards, etc. as context requires.

**2.9. "Vendor" or "Vendors"** means any entity submitting a bid in response to the Solicitation, the entity that has been selected as the lowest responsible bidder, or the entity that has been awarded the Contract as context requires.



**Construction/Project Oversight:** This Contract becomes effective on the effective start date listed on the first page of this Contract, identified as the State of West Virginia contract cover page containing the signatures of the State Agency (or another page identified as \_\_\_\_\_), and continues until the project for which the vendor is providing oversight is complete.

**Other:** See attached.

**4. AUTHORITY TO PROCEED:** Vendor is authorized to begin performance of this contract on the date of encumbrance listed on the front page of the Award Document unless either the box for “Fixed Period Contract” or “Fixed Period Contract with Renewals” has been checked in Section 3 above. If either “Fixed Period Contract” or “Fixed Period Contract with Renewals” has been checked, Vendor must not begin work until it receives a separate notice to proceed from the State. The notice to proceed will then be incorporated into the Contract via change order to memorialize the official date that work commenced.

**5. QUANTITIES:** The quantities required under this Contract shall be determined in accordance with the category that has been identified as applicable to this Contract below.

**Open End Contract:** Quantities listed in this Solicitation/Award Document are approximations only, based on estimates supplied by the Agency. It is understood and agreed that the Contract shall cover the quantities actually ordered for delivery during the term of the Contract, whether more or less than the quantities shown.

**Service:** The scope of the service to be provided will be more clearly defined in the specifications included herewith.

**Combined Service and Goods:** The scope of the service and deliverable goods to be provided will be more clearly defined in the specifications included herewith.

**One Time Purchase:** This Contract is for the purchase of a set quantity of goods that are identified in the specifications included herewith. Once those items have been delivered, no additional goods may be procured under this Contract without an appropriate change order approved by the Vendor, Agency, Purchasing Division, and Attorney General’s office.

**Construction:** This Contract is for construction activity more fully defined in the specifications.

**6. EMERGENCY PURCHASES:** The Purchasing Division Director may authorize the Agency to purchase goods or services in the open market that Vendor would otherwise provide under this Contract if those goods or services are for immediate or expedited delivery in an emergency. Emergencies shall include, but are not limited to, delays in transportation or an unanticipated increase in the volume of work. An emergency purchase in the open market, approved by the Purchasing Division Director, shall not constitute of breach of this Contract and shall not entitle the Vendor to any form of compensation or damages. This provision does not excuse the State from fulfilling its obligations under a One Time Purchase contract.

**7. REQUIRED DOCUMENTS:** All of the items checked below must be provided to the Agency by the Vendor as specified below.

**LICENSE(S) / CERTIFICATIONS / PERMITS:** In addition to anything required under the Section of the General Terms and Conditions entitled Licensing, the apparent successful Vendor shall furnish proof of the following licenses, certifications, and/or permits upon request and in a form acceptable to the State. The request may be prior to or after contract award at the State's sole discretion.

West Virginia Contractor's License

The apparent successful Vendor shall also furnish proof of any additional licenses or certifications contained in the specifications regardless of whether or not that requirement is listed above.

**8. INSURANCE:** The apparent successful Vendor shall furnish proof of the insurance identified by a checkmark below on each policy prior to Contract award. The insurance coverages identified below must be maintained throughout the life of this contract. Thirty (30) days prior to the expiration of the insurance policies Vendor shall provide the Agency with proof that the insurance

mandated herein has been continued. Vendor must also provide Agency with immediate notice of any changes in its insurance policies, including but not limited to, policy cancelation, policy reduction, or change in insurers. The apparent successful Vendor shall also furnish proof of any additional insurance requirements contained in the specifications prior to Contract award regardless of whether or not that insurance requirement is listed in this section.

Vendor must maintain:

**Commercial General Liability Insurance** in at least an amount of:  
1,000,000.00 per occurrence.

**Automobile Liability Insurance** in at least an amount of: 1,000,000.00 per occurrence.

**Professional/Malpractice/Errors and Omission Insurance** in at least an amount of: \_\_\_\_\_ per occurrence. Notwithstanding the forgoing, Vendor's are not required to list the State as an additional insured for this type of policy.

**Commercial Crime and Third Party Fidelity Insurance** in an amount of: \_\_\_\_\_ per occurrence.

**Cyber Liability Insurance** in an amount of: \_\_\_\_\_ per occurrence.

**Builders Risk Insurance** in an amount equal to 100% of the amount of the Contract.

**Pollution Insurance** in an amount of: \_\_\_\_\_ per occurrence.

**Aircraft Liability** in an amount of: \_\_\_\_\_ per occurrence.

**9. WORKERS' COMPENSATION INSURANCE:** Vendor shall comply with laws relating to workers compensation, shall maintain workers' compensation insurance when required, and shall furnish proof of workers' compensation insurance upon request.

**10. LIQUIDATED DAMAGES:** This clause shall in no way be considered exclusive and shall not limit the State or Agency's right to pursue any other available remedy. Vendor shall pay liquidated damages in the amount specified below or as described in the specifications:

\_\_\_\_\_ for \_\_\_\_\_

Liquidated Damages Contained in the Specifications.

Liquidated Damages Are Not Included in this Contract.

**11. ACCEPTANCE:** Vendor's signature on its bid, or on the certification and signature page, constitutes an offer to the State that cannot be unilaterally withdrawn, signifies that the product or service proposed by vendor meets the mandatory requirements contained in the Solicitation for that product or service, unless otherwise indicated, and signifies acceptance of the terms and conditions contained in the Solicitation unless otherwise indicated.

**12. PRICING:** The pricing set forth herein is firm for the life of the Contract, unless specified elsewhere within this Solicitation/Contract by the State. A Vendor's inclusion of price adjustment provisions in its bid, without an express authorization from the State in the Solicitation to do so, may result in bid disqualification. Notwithstanding the foregoing, Vendor must extend any publicly advertised sale price to the State and invoice at the lower of the contract price or the publicly advertised sale price.

**13. PAYMENT IN ARREARS:** Payments for goods/services will be made in arrears only upon receipt of a proper invoice, detailing the goods/services provided or receipt of the goods/services, whichever is later. Notwithstanding the foregoing, payments for software licenses, subscriptions, or maintenance may be paid annually in advance.

**14. PAYMENT METHODS:** Vendor must accept payment by electronic funds transfer or P-Card. (The State of West Virginia's Purchasing Card program, administered under contract by a banking institution, processes payment for goods and services through state designated credit cards.)

**15. ADDITIONAL FEES:** Vendor is not permitted to charge additional fees or assess additional charges that were not either expressly provided for in the solicitation published by the State of West Virginia, included in the Contract, or included in the unit price or lump sum bid amount that Vendor is required by the solicitation to provide. Including such fees or charges as notes to the solicitation may result in rejection of vendor's bid. Requesting such fees or charges be paid after the contract has been awarded may result in cancellation of the contract.

**16. TAXES:** The Vendor shall pay any applicable sales, use, personal property or any other taxes arising out of this Contract and the transactions contemplated thereby. The State of West Virginia is exempt from federal and state taxes and will not pay or reimburse such taxes.



**17. FUNDING:** This Contract shall continue for the term stated herein, contingent upon funds being appropriated by the Legislature or otherwise being made available. In the event funds are not appropriated or otherwise made available, this Contract becomes void and of no effect beginning on July 1 of the fiscal year for which funding has not been appropriated or otherwise made available. If that occurs, the State may notify the Vendor that an alternative source of funding has been obtained and thereby avoid the automatic termination. Non-appropriation or non-funding shall not be considered an event of default.

**18. CANCELLATION:** The State reserves the right to cancel this Contract immediately upon written notice to the vendor if the materials or workmanship supplied do not conform to the specifications contained in the Contract. The Agency may also cancel any purchase or Contract upon 30 days written notice to the Vendor in accordance with West Virginia Code of State Rules § 148-1-5.2.b.

**19. TIME:** Time is of the essence with regard to all matters of time and performance in this Contract.

**20. APPLICABLE LAW:** This Contract is governed by and interpreted under West Virginia law without giving effect to its choice of law principles. Any information provided in specification manuals, or any other source, verbal or written, which contradicts or violates the West Virginia Constitution, West Virginia Code or West Virginia Code of State Rules is void and of no effect.

**20A. VENUE:** All legal actions for damages brought by Vendor against the State shall be brought in the West Virginia Claims Commission. Other causes of action must be brought in the West Virginia court authorized by statute to exercise jurisdiction over it.

**21. COMPLIANCE WITH LAWS:** Vendor shall comply with all applicable federal, state, and local laws, regulations and ordinances. By submitting a bid, Vendor acknowledges that it has reviewed, understands, and will comply with all applicable laws, regulations, and ordinances. Vendor shall notify all subcontractors providing commodities or services related to this Contract that as subcontractors, they too are required to comply with all applicable laws, regulations, and ordinances.

**22. ARBITRATION:** Any references made to arbitration contained in this Contract, Vendor's bid, or in any American Institute of Architects documents pertaining to this Contract are hereby deleted, void, and of no effect.

**23. MODIFICATIONS:** This writing is the parties' final expression of intent. Notwithstanding anything contained in this Contract to the contrary, no modification of this Contract shall be binding without mutual written consent of the Agency, and the Vendor.

**24. WAIVER:** The failure of either party to insist upon a strict performance of any of the terms or provision of this Contract, or to exercise any option, right, or remedy herein contained, shall not be construed as a waiver or a relinquishment for the future of such term, provision, option, right, or remedy, but the same shall continue in full force and effect. Any waiver must be expressly stated in writing and signed by the waiving party.

**25. SUBSEQUENT FORMS:** The terms and conditions contained in this Contract shall supersede any and all subsequent terms and conditions which may appear on any form documents submitted by Vendor to the Agency or Purchasing Division such as price lists, order forms, invoices, sales agreements, or maintenance agreements, and includes internet websites or other electronic documents. Acceptance or use of Vendor's forms does not constitute acceptance of the terms and conditions contained thereon.

**26. ASSIGNMENT:** Neither this Contract nor any monies due, or to become due hereunder, may be assigned by the Vendor without the express written consent of the Agency and any other government agency or office that may be required to approve such assignments.

**27. WARRANTY:** The Vendor expressly warrants that the goods and/or services covered by this Contract will: (a) conform to the specifications, drawings, samples, or other description furnished or specified by the Agency; (b) be merchantable and fit for the purpose intended; and (c) be free from defect in material and workmanship.

**28. STATE EMPLOYEES:** State employees are not permitted to utilize this Contract for personal use and the Vendor is prohibited from permitting or facilitating the same.

**29. PRIVACY, SECURITY, AND CONFIDENTIALITY:** The Vendor agrees that it will not disclose to anyone, directly or indirectly, any such personally identifiable information or other confidential information gained from the Agency, unless the individual who is the subject of the information consents to the disclosure in writing or the disclosure is made pursuant to the Agency's policies, procedures, and rules. Vendor further agrees to comply with the Confidentiality Policies and Information Security Accountability Requirements, set forth in [www.state.wv.us/admin/purchase/privacy](http://www.state.wv.us/admin/purchase/privacy).

**30. YOUR SUBMISSION IS A PUBLIC DOCUMENT:** Vendor's entire response to the Solicitation and the resulting Contract are public documents. As public documents, they will be disclosed to the public following the bid/proposal opening or award of the contract, as required by the competitive bidding laws of West Virginia Code §§ 5A-3-1 et seq., 5-22-1 et seq., and 5G-1-1 et seq. and the Freedom of Information Act West Virginia Code §§ 29B-1-1 et seq.

DO NOT SUBMIT MATERIAL YOU CONSIDER TO BE CONFIDENTIAL, A TRADE SECRET, OR OTHERWISE NOT SUBJECT TO PUBLIC DISCLOSURE.

Submission of any bid, proposal, or other document to the Purchasing Division constitutes your explicit consent to the subsequent public disclosure of the bid, proposal, or document. The Purchasing Division will disclose any document labeled "confidential," "proprietary," "trade secret," "private," or labeled with any other claim against public disclosure of the documents, to include any "trade secrets" as defined by West Virginia Code § 47-22-1 et seq. All submissions are subject to public disclosure without notice.

**31. LICENSING:** In accordance with West Virginia Code of State Rules § 148-1-6.1.e, Vendor must be licensed and in good standing in accordance with any and all state and local laws and requirements by any state or local agency of West Virginia, including, but not limited to, the West Virginia Secretary of State's Office, the West Virginia Tax Department, West Virginia Insurance Commission, or any other state agency or political subdivision. Obligations related to political subdivisions may include, but are not limited to, business licensing, business and occupation taxes, inspection compliance, permitting, etc. Upon request, the Vendor must provide all necessary releases to obtain information to enable the Purchasing Division Director or the Agency to verify that the Vendor is licensed and in good standing with the above entities. Vendor shall notify all subcontractors providing commodities or services related to this Contract that as subcontractors, they too are required to be licensed, in good standing, and up-to-date on all state and local obligations as described in this section.

**32. ANTITRUST:** In submitting a bid to, signing a contract with, or accepting an Award Document from any agency of the State of West Virginia, the Vendor agrees to convey, sell, assign, or transfer to the State of West Virginia all rights, title, and interest in and to all causes of action it may now or hereafter acquire under the antitrust laws of the United States and the State of West Virginia for price fixing and/or unreasonable restraints of trade relating to the particular commodities or services purchased or acquired by the State of West Virginia. Such assignment shall be made and become effective at the time the purchasing agency tenders the initial payment to Vendor.

**33. VENDOR NON-CONFLICT:** Neither Vendor nor its representatives are permitted to have any interest, nor shall they acquire any interest, direct or indirect, which would compromise the performance of its services hereunder. Any such interests shall be promptly presented in detail to the Agency.

**34. VENDOR RELATIONSHIP:** The relationship of the Vendor to the State shall be that of an independent contractor and no principal-agent relationship or employer-employee relationship is contemplated or created by this Contract. The Vendor as an independent contractor is solely liable for the acts and omissions of its employees and agents. Vendor shall be responsible for selecting, supervising, and compensating any and all individuals employed pursuant to the terms of this Solicitation and resulting contract. Neither the Vendor, nor any employees or subcontractors of the Vendor, shall be deemed to be employees of the State for any purpose whatsoever. Vendor shall be exclusively responsible for payment of employees and contractors for all wages and salaries, taxes, withholding payments, penalties, fees, fringe benefits, professional liability insurance premiums, contributions to insurance and pension, or other deferred compensation plans, including but not limited to, Workers' Compensation and Social Security obligations, licensing fees, etc. and the filing of all necessary documents, forms, and returns pertinent to all of the foregoing. Vendor shall hold harmless the State, and shall provide the State and Agency with a defense against any and all claims including, but not limited to, the foregoing payments, withholdings, contributions, taxes, Social Security taxes, and employer income tax returns.

**35. INDEMNIFICATION:** The Vendor agrees to indemnify, defend, and hold harmless the State and the Agency, their officers, and employees from and against: (1) Any claims or losses for services rendered by any subcontractor, person, or firm performing or supplying services, materials, or supplies in connection with the performance of the Contract; (2) Any claims or losses resulting to any person or entity injured or damaged by the Vendor, its officers, employees, or subcontractors by the publication, translation, reproduction, delivery, performance, use, or disposition of any data used under the Contract in a manner not authorized by the Contract, or by Federal or State statutes or regulations; and (3) Any failure of the Vendor, its officers, employees, or subcontractors to observe State and Federal laws including, but not limited to, labor and wage and hour laws.

**36. NO DEBT CERTIFICATION:** In accordance with West Virginia Code §§ 5A-3-10a and 5-22-1(i), the State is prohibited from awarding a contract to any bidder that owes a debt to the State or a political subdivision of the State. By submitting a bid, or entering into a contract with the State, Vendor is affirming that (1) for construction contracts, the vendor is not in default on any monetary obligation owed to the state or a political subdivision of the state, and (2) for all other contracts, that neither vendor nor any related party owe a debt as defined above and that neither Vendor nor any related party are in employer default as defined in the statute cited above unless the debt or employer default is permitted under the statute.

**37. CONFLICT OF INTEREST:** Vendor, its officers or members or employees, shall not presently have or acquire an interest, direct or indirect, which would conflict with or compromise the performance of its obligations hereunder. Vendor shall periodically inquire of its officers, members and employees to ensure that a conflict of interest does not arise. Any conflict of interest discovered shall be promptly presented in detail to the Agency.

**38. REPORTS:** Vendor shall provide the Agency and/or the Purchasing Division with the following reports identified by a checked box below:

Such reports as the Agency and/or the Purchasing Division may request. Requested reports may include, but are not limited to, quantities purchased, agencies utilizing the contract, total contract expenditures by agency, etc.

Quarterly reports detailing the total quantity of purchases in units and dollars, along with a listing of purchases by agency. Quarterly reports should be delivered to the Purchasing Division via email at [purchasing.division@wv.gov](mailto:purchasing.division@wv.gov).

**39. BACKGROUND CHECK:** In accordance with W. Va. Code § 15-2D-3, the State reserves the right to prohibit a service provider's employees from accessing sensitive or critical information or to be present at the Capitol complex based upon results addressed from a criminal background check. Service providers should contact the West Virginia Division of Protective Services by phone at (304) 558-9911 for more information.

**40. PREFERENCE FOR USE OF DOMESTIC STEEL PRODUCTS:** Except when authorized by the Director of the Purchasing Division pursuant to W. Va. Code § 5A-3-56, no contractor may use or supply steel products for a State Contract Project other than those steel products made in the United States. A contractor who uses steel products in violation of this section may be subject to civil penalties pursuant to W. Va. Code § 5A-3-56. As used in this section:

a. "State Contract Project" means any erection or construction of, or any addition to, alteration of or other improvement to any building or structure, including, but not limited to, roads or highways, or the installation of any heating or cooling or ventilating plants or other equipment, or the supply of and materials for such projects, pursuant to a contract with the State of West Virginia for which bids were solicited on or after June 6, 2001.

b. "Steel Products" means products rolled, formed, shaped, drawn, extruded, forged, cast, fabricated or otherwise similarly processed, or processed by a combination of two or more or such operations, from steel made by the open heath, basic oxygen, electric furnace, Bessemer or other steel making process. The Purchasing Division Director may, in writing, authorize the use of foreign steel products if:

c. The cost for each contract item used does not exceed one tenth of one percent (.1%) of the total contract cost or two thousand five hundred dollars (\$2,500.00), whichever is greater. For the purposes of this section, the cost is the value of the steel product as delivered to the project; or

d. The Director of the Purchasing Division determines that specified steel materials are not produced in the United States in sufficient quantity or otherwise are not reasonably available to meet contract requirements.

**41. PREFERENCE FOR USE OF DOMESTIC ALUMINUM, GLASS, AND STEEL:** In Accordance with W. Va. Code § 5-19-1 et seq., and W. Va. CSR § 148-10-1 et seq., for every contract or subcontract, subject to the limitations contained herein, for the construction, reconstruction, alteration, repair, improvement or maintenance of public works or for the purchase of any item of machinery or equipment to be used at sites of public works, only domestic aluminum, glass or steel products shall be supplied unless the spending officer determines, in writing, after the receipt of offers or bids, (1) that the cost of domestic aluminum, glass or steel products is unreasonable or inconsistent with the public interest of the State of West Virginia, (2) that domestic aluminum, glass or steel products are not produced in sufficient quantities to meet the contract requirements, or (3) the available domestic aluminum, glass, or steel do not meet the contract specifications. This provision only applies to public works contracts awarded in an amount more than fifty thousand dollars (\$50,000) or public works contracts that require more than ten thousand pounds of steel products.

The cost of domestic aluminum, glass, or steel products may be unreasonable if the cost is more than twenty percent (20%) of the bid or offered price for foreign made aluminum, glass, or steel products. If the domestic aluminum, glass or steel products to be supplied or produced in a "substantial labor surplus area", as defined by the United States Department of Labor, the cost of domestic aluminum, glass, or steel products may be unreasonable if the cost is more than thirty percent (30%) of the bid or offered price for foreign made aluminum, glass, or steel products. This preference shall be applied to an item of machinery or equipment, as indicated above, when the

item is a single unit of equipment or machinery manufactured primarily of aluminum, glass or steel, is part of a public works contract and has the sole purpose or of being a permanent part of a single public works project. This provision does not apply to equipment or machinery purchased by a spending unit for use by that spending unit and not as part of a single public works project.

All bids and offers including domestic aluminum, glass or steel products that exceed bid or offer prices including foreign aluminum, glass or steel products after application of the preferences provided in this provision may be reduced to a price equal to or lower than the lowest bid or offer price for foreign aluminum, glass or steel products plus the applicable preference. If the reduced bid or offer prices are made in writing and supersede the prior bid or offer prices, all bids or offers, including the reduced bid or offer prices, will be reevaluated in accordance with this rule.

**42. PROHIBITION AGAINST USED OR REFURBISHED:** Unless expressly permitted in the solicitation published by the State, Vendor must provide new, unused commodities, and is prohibited from supplying used or refurbished commodities, in fulfilling its responsibilities under this Contract.

**43. VOID CONTRACT CLAUSES** – This Contract is subject to the provisions of West Virginia Code § 5A-3-62, which automatically voids certain contract clauses that violate State law.



**DESIGNATED CONTACT: Vendor appoints the individual identified in this Section as the Contract Administrator and the initial point of contact for matters relating to this Contract.**

Megan Temple  
**(Printed Name and Title)**  
P.O. Box 66, 1731 Old SR7, Rayland, Ohio 43943  
**(Address)**  
(740) 391-5918 / (740) 422-1351  
**(Phone Number) / (Fax Number)**  
m.temple@shellyandsands.com  
**(E-mail address)**

**CERTIFICATION AND SIGNATURE:** By signing below, or submitting documentation through wvOASIS, I certify that I have reviewed this Solicitation in its entirety; that I understand the requirements, terms and conditions, and other information contained herein; that this bid, offer or proposal constitutes an offer to the State that cannot be unilaterally withdrawn; that the product or service proposed meets the mandatory requirements contained in the Solicitation for that product or service, unless otherwise stated herein; that the Vendor accepts the terms and conditions contained in the Solicitation, unless otherwise stated herein; that I am submitting this bid, offer or proposal for review and consideration; ; that this bid or offer was made without prior understanding, agreement, or connection with any entity submitting a bid or offer for the same material, supplies, equipment or services; that this bid or offer is in all respects fair and without collusion or fraud; that this Contract is accepted or entered into without any prior understanding, agreement, or connection to any other entity that could be considered a violation of law; that I am authorized by the Vendor to execute and submit this bid, offer, or proposal, or any documents related thereto on Vendor's behalf; that I am authorized to bind the vendor in a contractual relationship; and that to the best of my knowledge, the Vendor has properly registered with any State agency that may require registration.

*By signing below, I further certify that I understand this Contract is subject to the provisions of West Virginia Code § 5A-3-62, which automatically voids certain contract clauses that violate State law.*

kelly Paving, Inc.  
**(Company)**  
  
**(Signature of Authorized Representative)**

Rita Lantz, Assistant Vice-President  
**(Printed Name and Title of Authorized Representative)**

October 31, 2023  
**(Date)**

(740) 859-2104 / (740) 422-1351  
**(Phone Number) (Fax Number)**

REQUEST FOR QUOTATION  
Asphalt Materials, Delivery & Labor by Vendor by County

---

SPECIFICATIONS

1. **PURPOSE AND SCOPE:** The West Virginia Division of Highways is soliciting bids to establish an open-end Asphalt contract for use on preventive maintenance and repair projects throughout the state of West Virginia to include materials, delivery, and labor by the Vendor to WVDOH project sites.
  
2. **DEFINITIONS:** The terms listed below shall have the following meanings assigned to them throughout and for the purpose of this Solicitation. Additional definitions can be found in Section 2 of the General Terms and Conditions.
  - 2.1 **“ADO” or Agency “Delivery Order”** - A written order entered by WVDOH personnel in the wvOASIS financial system against a master agreement, authorizing quantities of commodities and/or services to be delivered in accordance with all terms, conditions, and prices stipulated in the original contract.
  
  - 2.2 **“Approved Source,” “Approved Plant,” “Approved Product,” or “Approved Vendor”** - Terms which refers to the Approved Product Lists (APL) of certified manufacturers and/or products that meet acceptable levels of quality as determined by WVDOH Materials Control, Soils and Testing Division (MCS&T). These lists are updated periodically, and it is the Vendors responsibility to refer to the MCS&T website to ensure compliance.  
[https://transportation.wv.gov/highways/mcst/Pages/APL\\_By\\_Number.aspx](https://transportation.wv.gov/highways/mcst/Pages/APL_By_Number.aspx).
  
  - 2.3 **“Asphalt”, “Hot Mix Asphalt” and “HMA”** - Terms used interchangeably for asphalt.
  
  - 2.4 **“Contract Item” or “Contract Item(s)”** – Contract Items are identified in Section 3.2 of this Solicitation.
  
  - 2.5 **“Contractor” or “Vendor”** - Interchangeably used throughout this Solicitation and in any cited Sections of the West Virginia Department of Transportation, Division of Highways Standard Specifications, Roads and Bridges, adopted latest Standard Specs edition, as amended, including any Supplementals and refers to any entity submitting a bid in response to the Solicitation, the entity that has been selected as the lowest responsible bidder, or the entity that has been awarded the Contract, as context requires.
  
  - 2.6 **“Emergency Work”**- Means work which is required to be done without delay owing to circumstances for which the WVDOH could not have reasonably expected and has been designated as such by a representative of the WVDOH.



REQUEST FOR QUOTATION  
Asphalt Materials, Delivery & Labor by Vendor by County

---

- 2.7 “ESAL” – Means equivalent single axle load. ESAL establishes a damage relationship for comparing the effects of axles carrying different loads.
- 2.8 “FOB” or “Free on Board” – Indicates that the price for goods includes delivery at the Vendor’s expense to a specified point, and that the Vendor retains liability for loss or damage until the goods are delivered.
- 2.9 “HPTO” - High Performance Thin Overlay.
- 2.10 “Liquidated Damages” - Monetary compensation due from the Vendor in the event the Vendor’s performance falls short of contractual stipulation or breaches the contract. Delays in the delivery of goods and/or services or quality failures or corrections by the Vendor may result in the Agency assessing charges for such deficiencies per these contract Specifications, the Standard Specs Section 108.7, as amended, and calculated from the table posted in Section 8.4.1 of these Specifications.
- 2.11 “MCS&T” - The WVDOH Materials Control, Soils and Testing Division, who perform all procedures necessary with sampling, testing, reporting and inspection of products and materials to maintain a reliable quality assurance system. Reference: <https://transportation.wv.gov/highways/mcst/Pages/default.aspx>.
- 2.12 “MP” - Material Procedures, as amended, issued by the WVDOH Materials Control, Soils and Testing Division. The MP number references throughout these Contract Specifications are available by MP number at: <https://transportation.wv.gov/highways/mcst/Pages/WVDOH-Materials-Procedures.aspx>
- 2.13 “PG” – Performance Graded.
- 2.14 “Plant Information Form” and “Information Form” - **Mandatory forms which the Vendor must complete and submit with their bid** to identify each of the Vendor’s sourced Plants. Vendor shall provide Plant name, location, and counties served for each Plant sourced for asphalt and/or stone Materials associated with this contract’s Pricing Pages. Plant Information forms are mandatory and must accompany their respective Pricing Pages and be submitted at the time of bid. **This Solicitation requires a minimum of TWO (2) Plant Information Forms: Attachment C Asphalt Plant Information Form (ATT C) and Attachment D Stone Plant Information Form (ATT D).**
- 2.15 “Pricing Pages” - The schedule of prices attached hereto as **Attachment A Pricing Pages (ATT A)** and **Attachment B Mobilization Pricing Pages (ATT**

REQUEST FOR QUOTATION  
Asphalt Materials, Delivery & Labor by Vendor by County

---

**B)** which are used to evaluate the Solicitation responses. There are TWO (2) sets of Pricing Pages.

**NOTE:** Vendor's Pricing Pages shall accompany and correspond with Vendor's Plant Information forms.

- 2.16 "RPM" - Raised Pavement Markers.
- 2.17 "RAP" - Reclaimed Asphalt Pavement.
- 2.18 "Solicitation" – means the official notice of an opportunity to supply the State with goods and/or services that is published by the West Virginia Division of Highways.
- 2.19 "SP" - WVDOH Special Provision.
- 2.20 "Standard Specs" – used throughout this solicitation means the West Virginia Department of Transportation, Division of Highways Standard Specifications, Roads and Bridges, most recent edition, as modified or amended by all subsequent Supplemental Specifications.
- 2.21 VRAM – Void Reducing Asphalt Membrane.
- 2.22 "WVDOH" or "Agency"–means the West Virginia Division of Highways.

**3. GENERAL REQUIREMENTS:**

- 3.1 **Standard Specifications Roads and Bridges:** The following Standard Specs Sections shall apply, as applicable, to the administration of this contract: 101, 102, 103, 104, 105, 106, 107, 108, 109, and 110, as amended.

Materials, equipment, and performance of this contract shall conform, but is not limited to, the requirements of Sections 307, 401, 402, 408, 415, 636, and 703, as amended.

**Note:** All coarse aggregate used for any items listed in this contract shall meet the requirements of Section 703 of the Standard Specifications. Note 1 of Section 401.2 of the Standard Specifications shall not apply.

Free electronic copies of the Standard Specs and Supplementals are available at: <https://transportation.wv.gov/highways/TechnicalSupport/specifications/Pages/default.aspx>.

REQUEST FOR QUOTATION  
Asphalt Materials, Delivery & Labor by Vendor by County

---

- 3.2 Contract Items and Mandatory Requirements:** Vendor shall provide Agency with the Contract Items listed below on an open-end and continuing basis. Contract Items must meet or exceed the mandatory requirements as shown below.

**NOTE: Materials and Laydown services must be bid on by a single vendor to be considered for contract award. Bid responses received for materials only or for laydown services only will be disqualified. WVDOH will not coordinate the ordering and payment of material and laydown services with separate vendors.**

**3.2.1 Asphalt Materials:**

**Contract Items 1 through 17 are considered Asphalt Materials.** Materials from this contract SHALL ONLY be purchased when delivery by the Vendor and Labor by the Vendor are required on a Delivery Order. All materials used on this contract shall be from WVDOH Approved Sources/Plants, as amended.

**3.2.2 Shoulder Stone:**

**3.2.2.1 Shoulder Stone Placement, Section 307, Class 10, Contract Item 18,** shall meet the requirements of the Standard Detail for **Shoulder Reconstruction and Restoring Shoulders for Guardrail, shown in Exhibit 1 (EXH 1)** or as directed by the Delivery Order and the WVDOH District Engineer or their designee and shall be bid per ton. Shoulder Stone Placement and Stone will be paid as **Contract Item 18.**

All labor, equipment, and material to complete **Item 18 “Shoulder Stone Placement for Asphalt Section 307-Class 10”** shall be included in the unit bid price. Any traffic control required shall be charged separately per Section 3.2.26 of these Contract Specifications and identified accordingly as **Contract Items 85 through 88.**

**3.2.2.2 Haul by Vendor – Stone, Contract Items 20 and 21,** is the distance over suitable routes selected by the WVDOH District Engineer or their designee using the allowed haul costs that will provide the lowest total cost to the WVDOH and shall be measured from the Vendor’s Stone plant location, which shall be identified by the Vendor on **Attachment D Stone Plant Information Form (ATT D),** to the WVDOH’s mid-point of the project.

Both in-state and out-of-state delivery route mileage will be calculated by the WVDOH, using the shortest route, by utilizing

REQUEST FOR QUOTATION  
Asphalt Materials, Delivery & Labor by Vendor by County

---

“Google Earth” or a similar source for routing from the Vendor’s plant location to the WVDOH mid-point of the project location. WVDOH will determine the route to be taken due to bridge and/or road restrictions which shall have acceptable load limits for both roads and bridges.

**3.2.2.3 Shoulder Stone Mobilization, Contract Item 19**, is to compensate Vendor for Mobilization of Shoulder Stone for Placement and shall be priced on **Attachment B Mobilization Pricing Pages (ATT B)** which shall correspond with Vendor’s **Attachment D Stone Plant Information Form (ATT D)**. Information Form includes counties sourced for Stone.

**3.2.3 Performance Graded Binders, Contract Items 22 and 23**, is a surcharge to compensate Vendor for supplying asphalt when the referenced binder is substituted for the standard binder.

**3.2.4 ESAL Surcharge, Contract Items 24 and 25**, is a surcharge to compensate Vendor for supplying other necessary aggregates or mix types when the asphalt design mix requires an ESAL rating of 3 million or greater. Mixes requiring less than 3 million ESAL’s do not qualify for this surcharge.

**3.2.5 Haul by Vendor – Asphalt, Contract Item 26 and 27**, is the distance over suitable routes selected by the WVDOH District Engineer or their designee using the allowed for haul costs that will provide the lowest total cost to the WVDOH and shall be measured from the Vendor’s plant location, which shall be identified on the **Attachment C Asphalt Plant Information Form (ATT C)** to the WVDOH’s mid-point of the project.

Both in-state and out-of-state delivery route mileage will be calculated by the WVDOH, using the shortest route, by utilizing “Google Earth” or a similar source for routing from the Vendor’s plant location to the WVDOH mid-point of the project location. WVDOH will determine the route to be taken due to bridge and/or road restrictions which shall have acceptable load limits for both roads and bridges. **Haul by Vendor will only be requested in combination with other awarded items.**

**3.2.6 Laydown of Materials, Contract Items 28 through 31**, shall provide Laydown services for Materials (**Contract Items 1 through 17**). Laydown shall be provided by the Vendor at projects designated by the WVDOH District Engineer or their designee.



REQUEST FOR QUOTATION  
Asphalt Materials, Delivery & Labor by Vendor by County

---

**3.2.6.1 Safety Edge™:** As per the Standard Spec Sections 410.10.2 and 401.10.6, and **Safety Edge Design Directive 650, Exhibit 2 (EXH 2)**, when the total specified lift thickness of pavement is 1.5 inches or greater, the Vendor shall construct an outside pavement edge with Safety Edge™, where appropriate as described in **Safety Edge Design Directive 650, Exhibit 2 (EXH 2)**, unless Directed otherwise by the WVDOH District Engineer or their designee. Safety Edge™ shall be installed at no additional cost to the WVDOH. Vendors must use an Approved Asphalt Safety Edge™ Device (shoe) model listed on Division Approved Product Listing at [https://transportation.wv.gov/highways/mcst/Pages/APL\\_By\\_Number.aspx](https://transportation.wv.gov/highways/mcst/Pages/APL_By_Number.aspx), as amended. **Non-Approved Asphalt Safety Edge™ Device substitutions will not be accepted.**

**3.2.7 Excavation for Shoulder Paving, Contract Items 34 through 37**, shall consist of removing existing shoulder material for a length and width as directed by the WVDOH District Engineer or their designee in two inch (2") vertical increments. Cost of loading, hauling, and disposing of the excavated materials shall be included in the bid price for this item.

Replacement of Asphalt Base, Asphalt Wearing or Shoulder Stone Aggregate will be paid as shown in Sections 3.2.8 and 3.2.9.

**3.2.8 Asphalt Base I Shoulder Paving Surcharge, Contract Items 38 through 41**, is a surcharge for work performed to pave road shoulders consisting of installing and compacting Asphalt Base I to the elevation of the existing pavement in the shoulder that is to be paved.

Vendor shall comply with the **Repaving Pipe Trenches in Paved Shoulders Detail**, shown in **Exhibit 1 (EXH 1)**, where relevant work is performed.

**NOTE the following Asphalt Base I related line Contract Items:**

- Asphalt Base I will be paid as **Contract Item 1**.
- Hauling of Asphalt Base I will be paid as **Contract Items 26 and 27**.
- Laydown of Base I will be paid as **Contract Items 28 through 31**.
- Excavation for Base I will be paid as **Contract Items 34 through 37**.
- Shoulder Stone Placement/Restoring, and Stone will be paid as **Contract Item 18**.

**3.2.9 Asphalt Base II Shoulder Paving Surcharge, Contract Items 42 through 45**, is a surcharge for work performed to pave road shoulders

REQUEST FOR QUOTATION  
Asphalt Materials, Delivery & Labor by Vendor by County

---

consisting of installing and compacting Asphalt Base II to the elevation of the existing pavement in the shoulder that is to be paved.

Vendor shall comply with **Repaving Pipe Trenches in Paved Shoulders Detail**, shown in **Exhibit 1 (EXH 1)**, where relevant work is performed.

**NOTE the following Asphalt Base II related line Contract Items:**

Asphalt Base II will be paid as **Contract Item 3**.

Hauling of Asphalt Base II will be paid as **Contract Items 26 and 27**.

Laydown will be paid as **Contract Items 28 through 31**.

Excavation will be paid as **Contract Items 34 through 37**.

Shoulder Stone Placement/Restoring, and Stone will be paid as **Contract Item 18**.

**3.2.10 Tack Coat, Contract Item 46.** Asphalt Material for Tack Coat furnished and applied shall be in accordance with Standard Specs Section 408, as amended, as directed by the WVDOH District Engineer or their designee.

**3.2.11 Additional Heel-In Joints, Contract Item 47.** The beginning and the end of each paving location will be performed by the Vendor in accordance with the **Resurfacing Heel-In Detail** shown in **Exhibit 1 (EXH 1)**. Additional Heel-In Joints, in accordance with the Resurfacing Heel-In Detail, may be required as directed by the WVDOH District Engineer or their designee at intersecting roadways, at the beginning and end of each paving skip, and at other designated locations. Payment of Additional Heel-In Joints shall be paid per linear foot as measured along the joint, which shall be full payment for complete construction of the joint.

**3.2.12 Skip Paving Surcharge, Contract Item 48.** Skip Paving may be requested by the WVDOH District Engineer or their designee. A Skip Paving Surcharge will apply when the distance between the end of one skip and the beginning of the next exceeds 2,500 feet. Skip paving for distances less than 2500 feet from the end of one skip and the beginning of the next will not qualify for the Skip Paving Surcharge. Payment shall be made for each ton of final surface course material completed in place on the project. Patching and leveling in preparation for resurfacing of a project shall not be considered Skip Paving.

**3.2.13 Pavement Profiling/Milling** shall consist of profiling the existing pavement to the specified grade and cross slope by grinding, planing, or milling. The profiling equipment shall be capable of accurately establishing profile grades of 1/4" plus or minus, along each edge of the machine by reference from the existing pavement by use of ski or

REQUEST FOR QUOTATION  
Asphalt Materials, Delivery & Labor by Vendor by County

---

matching shoe or by reference to independent grade control. The equipment shall have an automatic system for controlling grade and cross slope. The Vendor shall provide adequate manpower and auxiliary equipment to control dust and remove cuttings from the project site. Stockpiling of cuttings on the project site will not be permitted.

The Vendor shall be responsible for damage to drainage facilities, manholes or other appurtenances within the pavement area.

**3.2.13.1 Pavement Profiling/Milling, Contract Items 49 through 60,** shall be measured as the total number of square yards planed or ground to a depth not exceeding two inches (2"). Should the required removal depth exceed two inches (2"), additional quantities shall be measured for each additional two inches (2") increment.

It shall be the WVDOH District Engineer or their designee's decision who retains ownership of the Profiled/Milled Cuttings: WVDOH or the Vendor. WVDOH will designate on the Delivery Order Contract Items 49 through 54, Pavement Profiling/Milling–WVDOH Owns Millings, or Contract Items 55 through 60, Pavement Profiling/Milling–Vendor Owns Millings, as per Section 7.2. Vendors shall factor in the haul cost of profiled/milled cuttings up to 10 miles, one way, in the bid price of **Contract Items 49 through 60**, regardless of who is to retain ownership of the Millings.

**3.2.13.2 Mobilization for Profiling/Milling, Contract Item 61** listed on **Attachment B Mobilization Pricing Pages (ATT B)**, includes all preparation operations including movement of necessary personnel and equipment onto the project site to begin the profiling or milling or fine milling work. Only one Mobilization for Profiling or Milling per Delivery Order shall be paid for Pavement Profiling/Milling or Fine Milling, **Contract Items 49 through 60**, or **Contract Items 69 through 80**.

**3.2.14 Haul of Profiled/Milled Cuttings or Fine Millings, Contract Items 62 and 63:** Profiled/Milled Cuttings or Fine Millings from the project site may be hauled by either WVDOH forces or the Vendor, as determined by the WVDOH District Engineer or their designee. When WVDOH retains ownership of the millings, **Contract Items 49 through 54 and Contract Items 69 through 74**, hauling of Profiled/Milled Cuttings or Fine Millings by the Vendor shall be to locations designated by the WVDOH District

REQUEST FOR QUOTATION  
Asphalt Materials, Delivery & Labor by Vendor by County

---

Engineer, or their designee. When Vendor retains ownership of the millings, **Contract Items 55 through 60 and 75 through 80**, hauling of Profiled/Milled Cuttings or Fine Millings by Vendor shall be calculated to the Vendor's nearest plant location. Mileage shall be calculated using the method described in Section 3.2.5.

The first 10 miles, one way, Haul of Profiled/Milled Cuttings or Fine Millings shall be included with the bid price of the Pavement Profiling/Milling, **Contract Items 49 through 60**, and Fine Millings, **Contract Items 69 through 80**, and shall not be charged for separately.

Haul of Profiled/Milled Cuttings or Fine Millings beyond the initial 10 miles shall be bid per ton-mile as **Contract Item 63**. **Contract Item 63** shall only be charged for mileage one way. Haul of Profiled/Milled Cuttings or Fine Millings shall be for full capacity truckloads (legal truckloads) only, except for the last haul of the day, which permits the hauling of a partial load at the same rate.

**3.2.15 Pavement Repair: Contract Item 64**, is for pavement repair work performed in conjunction with an overlay. Pavement Repair shall consist of squaring up the repair area, removing damaged material to a depth directed by the WVDOH District Engineer or their designee, hauling and disposing of existing pavement, tacking of existing surfaces and placing and compacting Asphalt Base II in lifts not exceeding two inches (2") to the level of the existing pavement. The cost of Asphalt Base II material shall be charged separately as **Contract Item 3**. Pavement Repair, **Contract Item 64**, does not qualify for Asphalt Price Adjustments; however, Asphalt Base II material used for Pavement Repair qualifies for price adjustment per Section 5 of these Contract Specifications.

All labor and equipment to complete **Contract Item 64** shall be included in the unit bid price for **Contract Item 64**. Any traffic control required shall be charged separately per Section 3.2.26 of these Contract Specifications and identified accordingly as **Contract Items 85 through 88**.

- **Base Failure Repair** shall be in accordance with **Base Failure Repair Detail** shown in **Exhibit 1 (EXH 1)**.
- **Edge Failure Repair** shall be in accordance with **Edge Failure Repair Detail** shown in **Exhibit 1 (EXH 1)**.



REQUEST FOR QUOTATION  
Asphalt Materials, Delivery & Labor by Vendor by County

---

- **Pothole Repair** shall be in accordance with **Pothole Repair Detail** shown in **Exhibit 1 (EXH 1)**.
- 3.2.16 Exhibit 3, SP401 Asphalt Base, Wearing and Patching, and Leveling Courses (EXH 3)**, as amended, shall address the use of increased amounts of RAP used within mixes produced for projects in the WVDOH construction program.
- 3.2.17 Crushed Aggregate Base Course:** RAP may be substituted for Class 10 Shoulder Stone materials on roadways where edge line pavement markings exist or are installed per Standard Specs Section 307, as amended.
- 3.2.18 Contract Item 65** shall be in accordance with **Exhibit 4, Asphalt High Performance Thin Overlay, SP496 (EXH 4)**, as amended.
- 3.2.18.1 Non-Tracking Tack, Contract Item 66**, is to be used with **Contract Item 65**, shall be a MCS&T Approved Product from an Approved Vendor per MP, as amended, and shall meet the recommended requirements of the supplier unless otherwise specified by the WVDOH District Engineer or their designee. The District Engineer or their designee may specify Non-Tracking Tack for purposes beyond Asphalt HPTO applications.
- 3.2.18.2 Laydown of Materials, Contract Item 67**, shall provide Laydown services for **Asphalt HTPO, Contract Item 65**. Any costs associated with the Material Transfer Device shall be included in the Vendor's bid price for Laydown. Laydown shall be provided by the Vendor at projects designated by the WVDOH District Engineer or their designee.
- 3.2.18.3 Asphalt HTPO, Contract Item 65**, shall be PG 64E-22 ordered in 400-ton increments and **Contract Item 66** shall also be requested in 400-ton increments or greater.
- Hauling for **Contract Item 65** shall be a separate bid item and not included in the combined material and laydown price. Hauling shall be charged per **Contract Items 26 and 27**.
- 3.2.19 Ultra-Thin Asphalt Overlay, Contract Item 68**, shall be in accordance with **Exhibit 5 – SP498 Ultra-Thin Asphalt Overlay (EXH 5)**, as amended. Laydown service shall be provided per Section 3.2.6 of these Contract Specifications.

REQUEST FOR QUOTATION  
Asphalt Materials, Delivery & Labor by Vendor by County

---

**3.2.20 Fine Milling of Asphalt Pavement Surfaces, Contract Item 69 through 80**, shall be the fine milling of existing and/or new asphalt pavement at locations shown on the plans or as directed by the WVDOH District Engineer or their designee in accordance with the Standard Test Method for Measuring Pavement Macrottexture Depth using a Volumetric Technique, MP 401.07.24.

It shall be the WVDOH District Engineer or their designee's decision who retains ownership of the Fine Milled Cuttings: WVDOH or the Vendor. WVDOH will designate on the Delivery Order **Contract Items 69 through 74, Fine Milling – WVDOH Owns Millings, or Contract Items 75 through 80, Fine Milling- Vendor Owns Millings**. Vendors shall factor in the haul cost of profiled/milled cuttings up to 10 miles, one way, in the bid price of these **Contract Items 69 through 80**, regardless of who is to retain ownership of the Millings.

**3.2.21 Rumble Strips:**

**3.2.21.1 Milled Rumble Strips, Contract Item 81**, shall be in accordance with the **Rumble Strip Special Detail** shown in **Exhibit 1 (EXH 1)**.

**3.2.21.2 Mobilization for Milled Rumble Strips, Contract Item 82, on Attachment B Mobilization Pricing Pages (ATT B)**, is all preparatory operations including movement of necessary personnel and equipment onto the project site to begin the work of Milling Rumble Strips. Only one Mobilization for Milling Rumble Strips per Delivery Order shall be paid when **Milled Rumble Strips, Contract Item 81**, are required.

**3.2.22 Parking Lot and Facility Paving Surcharge, Contract Item 83**, is a surcharge which shall be provided when materials, **Contract Items 1 through 17, 65, and 68**, are used to pave parking lots.

**3.2.23 Cleaning and Sweeping, Contract Item 84**, shall be calculated as the paving length times the width swept. The WVDOH shall have the option to perform Cleaning and Sweeping.

**3.2.24 Raised Pavement Markings, Contract Item 91 and 92**, must be stored and installed in accordance with Standard Specs Sections 420, 663, 715, and shall be in accordance with Raised Pavement Marker Types "P" and "R" Detail show in in Exhibit 1 (EXH 1). Vendor shall bid one price per installed marker on ATT A.

REQUEST FOR QUOTATION  
Asphalt Materials, Delivery & Labor by Vendor by County

---

**3.2.24.1** Type P-2 RPMs must be produced by a certified manufacturer listed on the APLS, as listed on the most recent APLS Material Code – 715.040.002 – Type P-2 Raised Pavement Markers.

Reference:

[https://transportation.wv.gov/highways/mcst/Pages/APL\\_By\\_Number.aspx](https://transportation.wv.gov/highways/mcst/Pages/APL_By_Number.aspx)

**3.2.24.2** Type R-4 RPMs must meet all ASTM D4280 standards addressed in Standard Specs section 715.40.6.2.

**3.2.24.3 Removal of Pavement Markings, Contract Item 94**, shall be removed per Standard Specs Sections 405, 420, and 663, except when the project plans indicate an alternative. Vendor shall bid one price per RPM removed.

**3.2.25 Void Reducing Asphalt Membrane, Contract Item 96**, shall be in accordance with **Exhibit 6 – SP403 Void Reducing Asphalt Membrane**, as amended.

**3.2.26 Maintaining Traffic:** While undergoing improvement, the project site shall be kept open to traffic in such condition that both local and through traffic will be adequately and safely accommodated. All improvement operations shall be scheduled by the Vendor to keep traffic delay to a minimum.

Traffic Control may be furnished by the WVDOH at the option of the District Engineer, or their designee; however, when Pilot Truck and Driver, Traffic Control Devices, Flagger, and/or Arrow Board, **Contract Items 85 through 88**, are requested by the WVDOH District Engineer or their designee for a project, traffic shall be maintained by the Vendor in accordance with Standard Specs Section 636, as amended.

**3.2.27 Mobilization for Paving Limits:** Vendor shall use **Attachment B Mobilization Pricing Pages (ATT B)** to provide pricing for all Mobilization Contract Items.

**Attachment B Mobilization Pricing Pages (ATT B) Contract Items are:**

- **Contract Item 19** is for Shoulder Stone Mobilization
- **Contract Item 32** is for DAYTIME Paving Mobilization
- **Contract Item 33** is for NIGHTTIME Paving Mobilization
- **Contract Item 61** is for Pavement Profiling/Milling Mobilization
- **Contract Item 82** is for Milled Rumble Strips Mobilization

REQUEST FOR QUOTATION  
Asphalt Materials, Delivery & Labor by Vendor by County

---

- **Contract Item 93** is for RPM Installation Mobilization
- **Contract Item 95** is for RPM Removal Mobilization
- **Contract Item 97** is for VRAM Mobilization

Only one mobilization for paving per day of operation will be paid, unless moves of over five (5) miles between individual paving locations are required. In cases where a Vendor is required to move from one roadway to the adjacent roadway of a divided highway, additional mobilization for paving will only be paid if the nearest interchange or crossing point that will accommodate the Vendor's equipment is over five (5) miles from the paving locations.

**3.2.27.1 Daytime Paving Mobilization, Contract Item 32**, is a mobilization for paving charge which may be made when the Delivery Order quantity, per paving location, is less than 500 tons of Asphalt and nighttime paving is not requested.

**3.2.27.2 Nighttime Paving Mobilization, Contract Item 33**, is a mobilization for paving charge which may be made when the Delivery Order directs that the paving is to be done at night.

**NOTE:** This provision may require roundtrip moves of up to ten (10) miles with no additional mobilization for paving payment.

An individual paving location shall be defined as a paving job where no skips exceeding 2,500 feet are involved, except between the approach slabs of a bridge or parallel pair of bridges.

**3.2.28 Off-Season Plant Opening, Contract Items 89 and 90**, is necessary if a Vendor is required to open their plant in the off-season to service the needs of the WVDOH, in which case an additional payment will be made. The Vendor will be paid an additional day charge for each additional consecutive day that the plant is open after the first day to service the needs of the WVDOH. If the plant produces no material for any use on any calendar day, either during the week or on the weekend, the WVDOH will pay the first day rate for off-season plant opening on the next day of the WVDOH usage. Payment for this item is subject to the following conditions:

**3.2.28.1** Payment for this item can only be authorized and made during the winter months, i.e., between December 15<sup>th</sup> and March 15<sup>th</sup>, and then only if the plant would not have otherwise been open. These dates may be revised by the WVDOH District Engineer or their designee, if necessary, to meet specific needs in the field. Any such revision of dates will be in writing and shall be

REQUEST FOR QUOTATION  
Asphalt Materials, Delivery & Labor by Vendor by County

---

attached to the Vendor's invoice at the time payment is requested.

**3.2.28.2** Payment will always be made at the full contract awarded bid price for the first day of plant opening; however, the amount paid from each additional day of plant opening will be reduced as follows:

- A. Payment for additional day charge will not be made if the plant has produced over 500 tons on that day. If between 300 and 500 tons have been produced, payment for additional day charge will be made equal to one-half of the contract awarded bid price for the additional day charge. The quantity produced to make this determination shall include all material produced that day, which includes tonnage bought by the WVDOH, other local governments and all private work.
- B. The WVDOH will only pay its share of the amount determined to be due for additional day charge as described above. For example, if the plant produces 375 tons and the WVDOH takes 150 tons of the total, 40% of the plant's daily production, payment for additional day charge would be calculated as follows: Since the total daily production is between 300 and 500 tons, the Vendor is due 50% of the additional day charge. Because the WVDOH's share of this daily production is 40%, the WVDOH would pay 40% of one-half of the additional day charge, or in this case, 20% of the additional day charges.

**3.2.28.3** A certified statement shall accompany the invoice stating the total quantity produced on the additional day. If payment does not qualify due to tonnage produced, the next consecutive day of plant operation, if any, will qualify for payment at the additional day rate rather than the first day rate for plant opening.

**3.2.29 Emergency Work: Emergency work as ordered by WVDOH District Engineer, or their designee is work that shall be initiated within forty-eight (48) hours from when the Delivery Order is received by the vendor. The determination of emergency work will be in accordance with Section 2.6 of these Contract Specifications. Emergency Work must be prominently noted on Delivery Order. Designated emergency projects will be paid at 1.50 times the vendor's bid price.**

REQUEST FOR QUOTATION  
Asphalt Materials, Delivery & Labor by Vendor by County

---

**4. PRICE ADJUSTMENTS:**

**4.1 Price Adjustment of Asphalt Cement:** Due to the uncertainty in estimating the cost of petroleum products that will be used during the life of this contract, adjustment in compensation for **Contract Items 1 through 17, 65 and 68** is provided for in the Standard Specs, as amended. Refer to the following table:

<b>Contract Item</b>	<b>Description of Asphalt Section</b>	<b>AC (Average Asphalt Content)</b>
1	Section 401 – Base I	3.9
2	Section 401 – 25mm Superpave	4.4
3	Section 401 – Base II	5.0
4	Section 401 – Patch and Level	5.0
5	Section 401 – Wearing IV	5.2
6	Section 402 – Wearing IV	5.1
7	Section 401 – 19mm Superpave	4.7
8	Section 401 – Scratch Course	6.2
9	Section 402 – 9.5mm Superpave	6.1
10	Section 401 – Wearing I	6.1
11	Section 402 – Wearing I	6.0
12	Section 401 – 4.75mm Superpave	7.6
13	Section 402 – 4.75mm Superpave	7.2
14	Section 401 – Wearing III	7.3
15	Section 402 – Wearing III	7.5
16	Section 401 - 12.5mm Superpave	5.6
17	Section 402 - 12.5mm Superpave	5.6
64	Asphalt HPTO, SP496	7.1
67	Ultra-Thin Asphalt Overlay, SP498	7.6

[Intentionally Left Blank]

REQUEST FOR QUOTATION  
Asphalt Materials, Delivery & Labor by Vendor by County

---

**4.2 Price Adjustment of Fuel Oil No. 2 (Diesel Fuel):** Due to the uncertainty in estimating the cost of diesel fuel that will be used during the life of this contract, adjustment in compensation for applicable items shall be per Standard Specs 109.9, as amended, with the exception that Factor “C” in the Price Adjustment for Fuel formula is to be broken down by component, as shown in Figure 4.2.A.

The Price Adjustment for Fuel formula to be utilized for this contract is:

$$Pa = [(Mbp \div Cbp) - 1.00] \times Cbp \times C \times Q$$

Where: Pa = Price Adjustment  
Mbp = Monthly base price at time of placement  
Cbp = Contract Base Price at time of bidding  
C = Cost Adjustment Factors per Unit, as per Figure 4.2.A  
Q = ‘As Constructed’ Quantity

**FIGURE 4.2.A**

Description	Factor	Unit	Applicable Item
Asphalt Material	0.43	Tons	Contract Items 1 -17, 65, and 68
Asphalt Hauling	0.020	Ton Miles	Contract Items 26 and 27
Asphalt Laydown	0.14	Tons	Contract Items 28 - 31
Aggregate Production (0.49) + Placement (0.03)	0.52	Tons	Contract Item 18
Aggregate Haul	0.020	Ton Miles	Contract Items 20 and 21
Excavating	0.25	Tons	Contract Items 34 - 37

**The bidding index for asphalt and fuel will be listed on the Contract Administration website for Fuel, Asphalt and Cement Prices Adjustments listed for October 2023. Contract Base Price at time of bid will be based on October 2023.**

<https://transportation.wv.gov/highways/contractadmin/Lettings/Pages/FuelandAsphaltPrices.aspx#FuelPrices>

**NOTE:** If the adjusted price of any Contract Item is less than \$0.00, WVDOH will limit the adjustment to \$0.00.

**5. ACCEPTANCE PLAN:** Quality control at the plant and in-the-field shall be the responsibility of the Vendor and shall meet the requirements of MP 401.03.50. Compaction quality control shall be in accordance with Section 401 of the Standard Specifications. Acceptance testing shall be the responsibility of the WVDOH. Quality assurance of the material shall be as set forth in MP 401.02.27 for Marshall Mix designs



REQUEST FOR QUOTATION  
Asphalt Materials, Delivery & Labor by Vendor by County

---

or MP 401.02.29 for Superpave mix designs. Referenced MP's, as amended, may be referenced at <https://transportation.wv.gov/highways/mcst/Pages/MP-400s.aspx>.

**6. CONTRACT AWARD:**

**6.1 Contract Award:** The Contract is intended to provide Agencies with a purchase price on all Contract Items. All qualified responsible Vendors shall be awarded a contract for those Contract Items bid which meet all mandatory requirements of this Contract. **Bidding vendor must provide both materials and laydown services within the same bid; bids received for materials only or bids received for laydown services only will be disqualified.** WVDOH will not coordinate materials and laydown services with separate vendors.

**6.1.1 DETERMINING LOW BID PER PROJECT:** To determine the low bid Vendor for individual repair paving projects, the WVDOH District Engineer or their designee will calculate the lowest overall total cost of the Contract Items required for individual projects. A written Delivery Order will be issued to the Vendor with the lowest overall total cost. Charges for hauling will be calculated according to Section 3.2.4 of these Contract Specifications.

WVDOH reserves the right to request any one or combination of items for which bids are awarded at the lowest overall total as set forth in this section.

**6.2 Pricing Pages, Attachment A ("ATT A") and Attachment B (ATT B):** Vendor shall clearly identify the applicable counties on **Attachment A Pricing Pages (ATT A)** Pricing Page by marking an "X" beside applicable county/counties for which the bid prices apply. Vendor shall clearly identify their bid, by county, on **Attachment B Mobilization Pricing Pages (ATT B)** by providing a lump sum price beside the applicable county/counties for each mobilization Contract Item they are bidding on, as listed in Section 3.2.25 of these Contract Specifications. The Pricing Pages spreadsheets list Contract Items with no guarantee that any Contract Item will be purchased throughout the life of this contract. Estimated quantities are not available.

**NOTE: Bids that do not include ATT A, ATT B, ATT C and ATT D WILL BE DISQUALIFIED.**

**6.2.1** Bid evaluations will be based on the bid prices submitted on the Pricing Pages Attachment A (ATT A) and Attachment B (ATT B). Vendor



REQUEST FOR QUOTATION  
Asphalt Materials, Delivery & Labor by Vendor by County

---

entries of bid prices or other notations made in wvOASIS commodity line descriptions will not be considered for bid evaluation or award.

- 6.2.2** Vendor should type or electronically enter the information into the Pricing Pages spreadsheet to prevent errors in the evaluation. Vendor should not place formulas or any type of Excel calculations into the List Price column, only the actual bid price per Contract Item. In most cases, the Pricing Pages are available in wvOASIS within the solicitation attachments, however, Vendors may request an electronic copy of the Pricing Pages spreadsheet for bid purposes by sending an email request to the following address: [DOTProcurement@wv.gov](mailto:DOTProcurement@wv.gov).
- 6.2.3** Changing a column or row description, Contract Item description, unit of measure on the **Pricing Pages, Attachment A (ATT A)** shall result in disqualification of the Contract Item bid on the altered line. In circumstances when all Contract Items must be bid for bid evaluation and contract award, the disqualification of any Contract Item will result in the disqualification of the entire bid.
- 6.2.4** Submitting Pricing Pages other than those provided with this solicitation, as described in Section 6.2 shall result in the disqualification of the Vendor's bid in its entirety.

- 6.3 Plant Information Forms, Attachment C (ATT C) and Attachment D (ATT D):** There are two (2) Plant Information Forms that must be submitted with corresponded Pricing Pages at the time of Bid: **Attachment C Asphalt Plant Information Form (ATT C)** identifies the Asphalt Plant and **Attachment D Stone Plant Information Form (ATT D)** identifies the Stone Plant for Shoulder Stone placement.

All Plant Information Forms shall be completed by Vendors and shall identify WVDOH Approved Plants, as amended, supplying materials associated with bid items on the Pricing Pages. Plant Information Forms shall include:

- Name of Vendor submitting the Plant Information Form as part of bid
- Plant Name
- Plant Locations 911 address or the most recent physical street address, city, and state
- Counties the listed Plant may supply materials to

**If the Vendor fails to provide the Asphalt (ATT C) or Stone (ATT D) Plant Location Information Form, identifying all plants from which asphalt or stone will be pulled from, their bid will be disqualified.**

REQUEST FOR QUOTATION  
Asphalt Materials, Delivery & Labor by Vendor by County

---

- 6.4 Contract Award Transition:** Upon the award of this contract, the WVDOH Operations Division will announce the effective date of use of this contract to the Districts and the Vendors, whether it is by the effective date, the completed and encumbered date, or an established date by the WVDOH. Upon the announced effective date of use, any Delivery Order issued prior to the award of the contract shall remain in effect and should not be cancelled until that Delivery Order is filled; however, after ten (10) working days of the Districts and Vendors notice, any Delivery Order that has not been completely filled by the Vendors shall NOT be completed, and a cancellation notice will be sent to that Vendor from the issuing District for cancellation of the balance of that Delivery Order only. No Delivery Orders from prior contracts should be held open by the Districts or the Vendors longer than ten (10) working days after the effective date of use is announced for the new contract.

This directive is issued to assist the Districts and the Vendors when fulfilling open Delivery Orders only. It is NOT issued to cause harm or to take contracts from one Vendor to give to another Vendor, but to establish a transition process from one contract into another contract.

**7. ORDERING AND PAYMENT:**

- 7.1 Ordering:** Vendor shall accept orders through regular mail, facsimile, email, or any other written forms of communication. Vendor shall maintain and keep current its phone numbers, fax number, email address, locations and ordering/billing/ payment addresses with WVDOH and in wvOASIS. Vendor may, but is not required to, accept online orders through a secure internet ordering portal/website. If Vendor has the ability to accept online orders, it should include in its response a brief description of how Agencies may utilize the online ordering system. Vendor shall ensure that its online ordering system is properly secured prior to processing Agency orders online.
- 7.2 Delivery Order:** WVDOH will initiate the Delivery Order by identifying locations of need. The Delivery Order will be generated by a WVDOH Engineer or their designee. The order should be completed on a WV-39 Blanket Release Order and an ADO entered into wvOASIS. The order should detail the need and location information of the work to be completed per Contract Items, as well as the tentative start and end dates, to become the agreed upon official start and end dates. Emergencies shall be prominently noted on the Delivery Order. Once complete, the Delivery Orders shall be sent to Vendor via fax, email, or postal mail. **Any verbal communications to initiate or make modifications to a project from this contract are not acceptable as a Delivery Order.**

REQUEST FOR QUOTATION  
Asphalt Materials, Delivery & Labor by Vendor by County

---

**7.2.1 Lead Time:** The WVDOH should plan accordingly to allow the Contractor a minimum of 14 calendar days prior to the date of the agreed upon work start date on the Delivery Order to allow Vendor to mobilize and begin work.

**7.3 Payment:** Upon completion of the work indicated on the Delivery Order, Vendor shall accept payment in accordance with the payment procedures of the State of West Virginia. The State of West Virginia currently utilizes a Purchasing Card program, administered under contract by a banking institution, as well as Electronic Funds Transfer as methods to process payment for goods and services. The Vendor shall accept the State of West Virginia's Purchasing Card and Electronic Funds Transfer for payment of orders under this Contract. Electronic Funds Transfer for payment is available through the WV State Auditor's Office. The Vendor may visit the WV State Auditor's website ([wvsao.gov](http://wvsao.gov)) for all necessary forms and instructions. Payment method may be dictated at WVDOH's discretion.

**8. PROJECT ACCEPTANCE, DELIVERY AND RETURN:**

**8.1 Project Acceptance and Written Verification of Receipt:** Upon receipt of a WVDOH Delivery Order, the Vendor shall advise the WVDOH in writing within five (5) calendar days of their acceptance or refusal of the Delivery Order. As verification of receipt, **Vendor must provide written acknowledgement of any Delivery Orders and any Revisions/Modifications thereto sent by WVDOH.** Failure to provide the WVDOH with written acknowledgement of any Delivery Orders/Revisions within five days of the Order being sent shall be considered refusal of the Delivery Order. Upon Vendor's acceptance, WVDOH should submit an ADO in wvOASIS and provide the Vendor with the ADO number for their reference.

In the event of refusal, the WVDOH at its own discretion shall cancel the Delivery Order and may seek to obtain the requested goods or services from another low bid Vendor or proceed with an Emergency Purchase from the open market. A Vendor refusing a Delivery Order forfeits their interest in the Delivery Order. For example, a vendor cannot decline work offered as lowest bid at Plant A with the expectation that the same work will be reoffered to them at Plant B, at a higher bid price, even if Plant B is the next low bid. While it is at the discretion of the Vendor to choose which plant to pull material from, the lowest bid price must still be honored.

**8.2 Negotiation of Dates:** The WVDOH shall have the option to negotiate with the Vendor, the project's tentative start and end dates. **Project work shall be continuous to completion unless otherwise approved in writing by the**

REQUEST FOR QUOTATION  
Asphalt Materials, Delivery & Labor by Vendor by County

---

**WVDOH District Engineer or their designee.**

- 8.3 Delivery Time:** The Vendor shall mobilize, commence, and complete work delivery in accordance with the WVDOH's written Delivery Order, per project. Any changes must be communicated by the Vendor in writing to the WVDOH District Engineer or their designee. The Vendor shall work in an efficient manner in effort to keep traffic delay to a minimum and traffic must be adequately and safely accommodated. Vendor shall ship/provide all orders in accordance with the dates assigned to each project per the Delivery Order and shall not hold orders until a minimum delivery quantity is met. **No Vendor is authorized to ship project related goods or begin work/services, nor is the WVDOH authorized to receive materials, prior to the issuance of a Delivery Order.**
- 8.4 Late Delivery:** The Agency placing the order under this Contract must be notified in writing if orders will be delayed for any reason. Any delay in delivery that could cause harm to an Agency will be grounds for cancellation of the delayed order, and/or obtaining the items ordered from a third party. Agency placing the Delivery Order under this Contract must be notified **in writing by the Vendor no later than five (5) business days prior to the scheduled start date from the Agency's order.** Any failure to notify, acknowledge receipt of WVDOH's written Delivery Orders/ Revisions resulting in delivery delay, or failure to start or complete the project per the WVDOH scheduled due dates may be determined by the WVDOH at its sole discretion as harmful to the Agency and as such, shall result in WVDOH's cancellation of the Delivery Order and application of Liquidated Damages.

Any Agency seeking to obtain items from a third party under this provision must first obtain approval of the WVDOH Budget & Procurement Division.

- 8.4.1 Liquidated Damages:** If the Vendor's work completion or corrections of deficient work exceeds the Delivery Order completion due date/timeframe, the Vendor shall agree that no extension of contract time will be granted unless Liquidated Damages are applied by the WVDOH in the form of an off-set reduction to the total amount of the Vendor's final invoice. The WVDOH shall calculate Liquidated Damages per project beginning on day one after the WVDOH's specified Delivery Order due date, in accordance with this Section, the contract's Terms and Conditions, and the Standard Specs Section 108.7, as amended, in the amounts in Table 108.7.1 from the Standard Specs as follows:

**TABLE 108.7.1  
Schedule of Liquidated Damages**

REQUEST FOR QUOTATION  
Asphalt Materials, Delivery & Labor by Vendor by County

---

Original Contract Amount		Daily Charges Per Calendar Day
For More Than	To and Including	
\$0	\$500,000	\$350
\$500,000	\$2,000,000	\$650
\$2,000,000	\$10,000,000	\$1,600
\$10,000,000	\$25,000,000	\$3,100
\$25,000,000		\$4,00

- 8.5 Adverse Weather Conditions:** Unsuitable/adverse/inclement weather conditions may dictate the work schedule. It is preferred that operations be suspended immediately when an inclement weather event begins or if the WVDOH District Engineer or their designee determines that an inclement weather event is imminent. If working conditions are dangerous or unsuitable for the WVDOH, Vendor, or general public, work shall be suspended by the WVDOH Engineer/designee. If needed, revision to the project's start and end date may be negotiated by the Vendor and the WVDOH Engineer/designee. After a weather-related suspension of work, the WVDOH District Engineer or their designee shall determine and convey in writing, such Delivery Order changes and when work shall commence/resume, followed by the Vendor's written acknowledgement, per Section 10.4 of this Contract Solicitation.
- 8.6 Delivery Payment/Risk of Loss: Delivery Payment/Risk of Loss:** Standard order delivery shall be F.O.B. Vendor's Plant Location. **Haul by Vendor, Contract Items 26 and 27,** shall be requested on the Delivery Order. Vendor shall include the cost/discount of standard order delivery charges in its bid pricing and is not permitted to charge the Agency separately for such delivery.
- 8.7 Project Acceptance Criteria:** The WVDOH District Engineer or their designee shall have final acceptance of the work done by the Vendor, per project. Any work found by the WVDOH District Engineer or their designee not performed in accordance with these contract Specifications and the Standard Specs, as amended, and/or found deficient and unacceptable by visual inspection will be rejected and, at the Vendor's/Contractor's expense, will be removed and replaced by the Vendor with work being continual until the Vendor's deficient work corrections are completed and deemed acceptable and approved by the WVDOH District Engineer or their designee. Under no circumstance shall the Vendor's deficiency corrections exceed twenty (20) calendar days unless otherwise declared in writing by the WVDOH District Engineer or their designee, subject to Liquidated Damages as per Section 10.4.1 of these Contract Specifications.
- 8.8 Rejection of Unacceptable Contract Items:** The decision of the WVDOH District Engineer or their designee regarding materials, workmanship, quality etc., shall be final per Standard Specs Section 105, as amended.

REQUEST FOR QUOTATION  
Asphalt Materials, Delivery & Labor by Vendor by County

---

**9. VENDOR DEFAULT:**

- 9.1** The following shall be considered a vendor default under this Contract.
- 9.1.1** Failure to provide Contract Items in accordance with the requirements contained herein.
- 9.1.2** Failure to comply with other specifications and requirements contained herein.
- 9.1.3** Failure to comply with any laws, rules, and ordinances applicable to the Contract Services provided under this Contract.
- 9.1.4** Failure to remedy deficient performance upon request.
- 9.2** The following remedies shall be available to Agency upon default.
- 9.2.1** Immediate cancellation of the Contract.
- 9.2.2** Immediate cancellation of one or more release orders issued under this Contract.
- 9.2.3** Any other remedies available in law or equity.

**10. MISCELLANEOUS:**

- 10.1 No Substitutions:** Vendor shall supply only Contract Items submitted in response to the Solicitation unless a contract modification is approved in accordance with the provisions contained in this Contract.
- 10.2 Vendor Supply:** Vendor must carry sufficient inventory of the Contract Items being offered to fulfill its obligations under this Contract. By signing its bid, Vendor certifies that it can supply the Contract Items contained in its bid response.
- 10.3 Vendor's Invoices:** Invoices for materials, **Contract Items 1 through 17, 64, 65, and 67**, must be submitted separately from all other items. All other items shall be submitted on a separate invoice. The Vendor's invoices must be submitted as an original containing the following information:
- All weigh ticket numbers for material delivered and cuttings hauled during the invoice period.

REQUEST FOR QUOTATION  
Asphalt Materials, Delivery & Labor by Vendor by County

---

- WVDOH Delivery Order number and this contract number.
- Total quantity and unit price with the total cost of each type of material furnished.
- No payment will be made to a Contractor for **Daytime Paving Mobilization, Contract Item 32**, unless the quantity is less than 500 tons or **Nighttime Paving Mobilization, Contract Item 33** unless the Delivery Order directs that the paving is to be done at night.

**10.4 Reports:** Vendor shall provide the Agency with quarterly reports, annual summaries, and/or monthly reports as requested by the Agency and/or the West Virginia Purchasing Division showing quantities, total dollar value of the Contract Items purchased, ordered, shipped & invoiced with dates in spreadsheet format as defined by the Agency. Failure to supply such reports may be grounds for cancellation of this Contract.

**10.5 Contract Manager:** During its performance of this Contract, Vendor must designate and maintain a primary contract manager responsible for overseeing Vendor's responsibilities under this Contract. The Contract Manager must be available during normal business hours to address any customer service or other issues related to this Contract. Vendor should list its Contract Manager and his or her contact information below.

**Contract Manager:** Megan Temple  
**Telephone Number:** (740) 391-5918  
**Fax Number:** (740) 422-1351  
**Email Address:** m.temple@shellyandsands.com

Vendor shall inform the Agency in writing of any changes to the information provided above within ten (10) calendar days of such changes. Failure to comply may be grounds for cancellation of this contract.

## Exhibit 1, Shoulder Reconstruction Detail

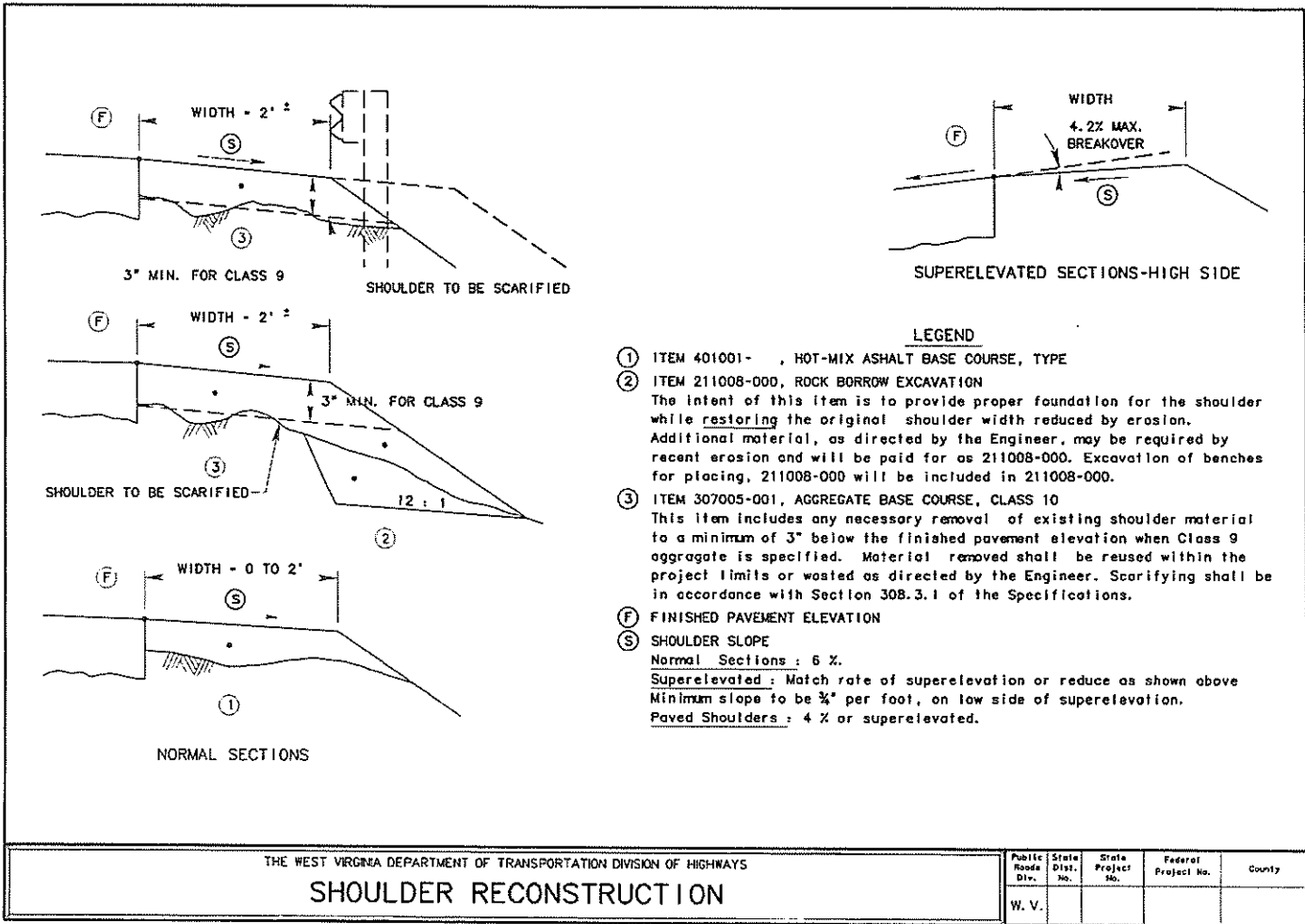



## Exhibit 1 - Restoring Shoulder for Guardrail Detail

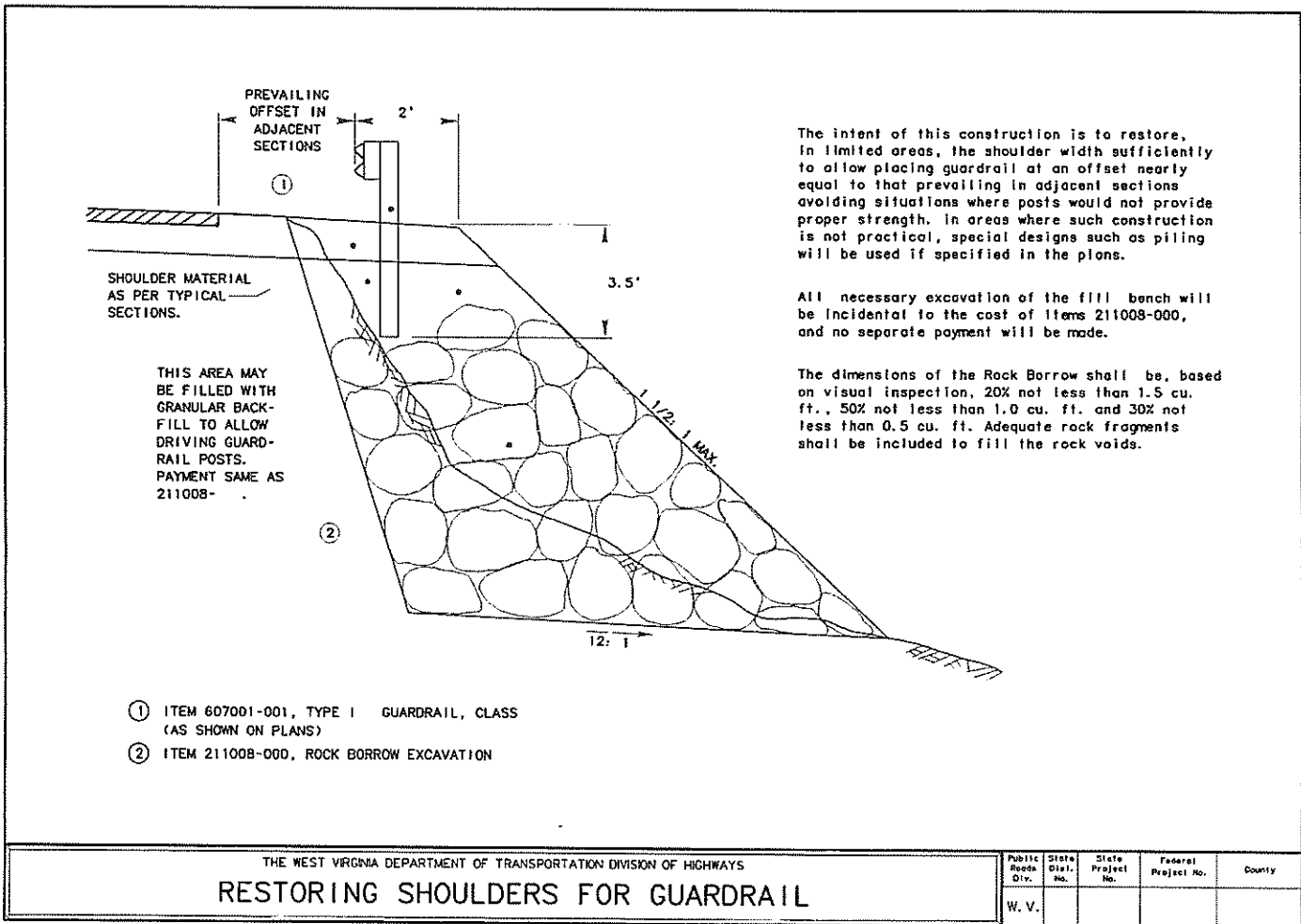

The intent of this construction is to restore, in limited areas, the shoulder width sufficiently to allow placing guardrail at an offset nearly equal to that prevailing in adjacent sections avoiding situations where posts would not provide proper strength. In areas where such construction is not practical, special designs such as piling will be used if specified in the plans.

All necessary excavation of the fill bench will be incidental to the cost of items 21100B-000, and no separate payment will be made.

The dimensions of the Rock Borrow shall be based on visual inspection, 20% not less than 1.5 cu. ft., 50% not less than 1.0 cu. ft. and 30% not less than 0.5 cu. ft. Adequate rock fragments shall be included to fill the rock voids.

## Exhibit 1 - Repaving Pipe Trenches in Paved Shoulder Detail

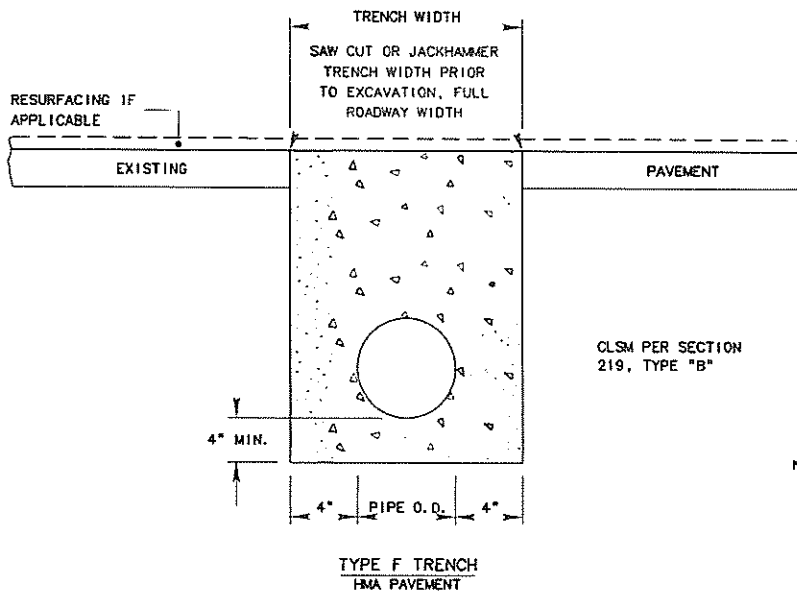

WHEN NO OVERLAY IS SPECIFIED THE CONTROLLED LOW-STRENGTH MATERIAL (CLSM) SHALL BE A MIN. OF 2000 psi FOR DOH PIPES ONLY. NOT TO BE USED FOR UTILITY PIPES.

NOTE: IF TYPE F TRENCH IS USED WHERE THERE IS NO EXISTING OR PROPOSED INLET, THE CLSM SHALL BE POURED FULL DEPTH 2' PAST EACH E.P. THE PIPE SHALL BE ENCASED IN 4" OF CLSM AN ADDITIONAL 10' MAX. BEYOND E.P. IF THERE IS AN EXISTING OR PROPOSED INLET THE CLSM SHALL BE POURED FULL DEPTH TO THE INLET.

THE WEST VIRGINIA DEPARTMENT OF TRANSPORTATION DIVISION OF HIGHWAYS  
**REPAVING PIPE TRENCHES IN PAVED SHOULDER**

Public Route Dist.	State Dist. No.	State Project No.	Federal Project No.	County
W. V.				

## Exhibit 1 - Resurfacing Heel-In Detail

### TEMPORARY WEDGES AT HEEL-INS

THE CONTRACTOR MAY ELECT TO CUT THE REQUIRED HEEL-INS SUCH THAT TRAFFIC MUST BE MAINTAINED OVER THE HEEL-IN AREAS PRIOR TO THE PLACEMENT OF THE PERMANENT HMA MATERIAL. IF THE CONTRACTOR CHOOSES THIS METHOD AS AN ALTERNATE TO CUTTING THE HEEL-INS AND BACKFILLING WITH PERMANENT HMA PRIOR TO RESTORING TRAFFIC. IT SHALL BE THE CONTRACTORS RESPONSIBILITY TO PLACE TEMPORARY HMA WEDGES 10 FEET IN LENGTH FOR EACH 1 INCH OF EXISTING SURFACE REMOVED AT THE VERTICAL FACE. FOR EXAMPLE, IF 2 INCHES ARE REMOVED AT THE VERTICAL FACE, THE TEMPORARY HMA WEDGE SHALL BE 20 FEET IN LENGTH. THE WEDGES SHALL BE CONSTRUCTED OF ITEM 401001-011, TYPE 19, PLACED AND COMPACTED IN ACCORDANCE WITH SECTION 401.14. THESE TEMPORARY WEDGES SHALL BE REMOVED IMMEDIATELY PRIOR TO PLACING THE PERMANENT SURFACE. THE COST OF THIS WORK WILL BE INCLUDED IN VARIOUS PAVEMENT ITEMS.

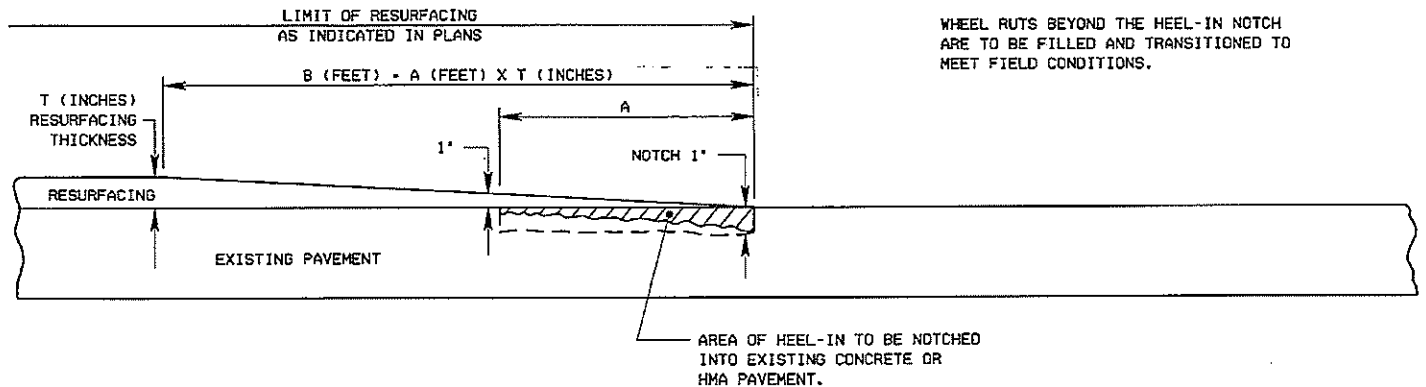

1. PAYMENT FOR HEEL-IN TO BE INCLUDED IN VARIOUS PAY ITEMS OF THIS PROJECT
2. THIS DETAIL TO BE USED AT TERMINI OF RESURFACING PROJECTS AND AT ALL TERMINI FOR SKIP RESURFACING PROJECTS.
3. THIS DETAIL TO BE USED AT LOCATIONS FOR HEEL-IN INTERSECTIONS OF THIS PROJECT.
4. THE FOLLOWING NUMBER(S) OF HEEL-INS FOR THE MAINLINE ON THIS PROJECT SHALL BE:  
PERPENDICULAR  
SKEWED AT

POSTED SPEED LIMIT	A
25 MPH	12'
30 TO 35 MPH	14'
40 TO 45 MPH	16'
50 TO 55 MPH	18'
60 TO 70 MPH	25'

THE WEST VIRGINIA DEPARTMENT OF TRANSPORTATION DIVISION OF HIGHWAYS

### RESURFACING HEEL-IN DETAIL

PUBLIC ROADS DIV.	STATE DIST. NO.	STATE PROJECT NO.	FEDERAL PROJECT NO.	COUNTY
W.V.				

## Exhibit 1 - Base Failure Repair Detail

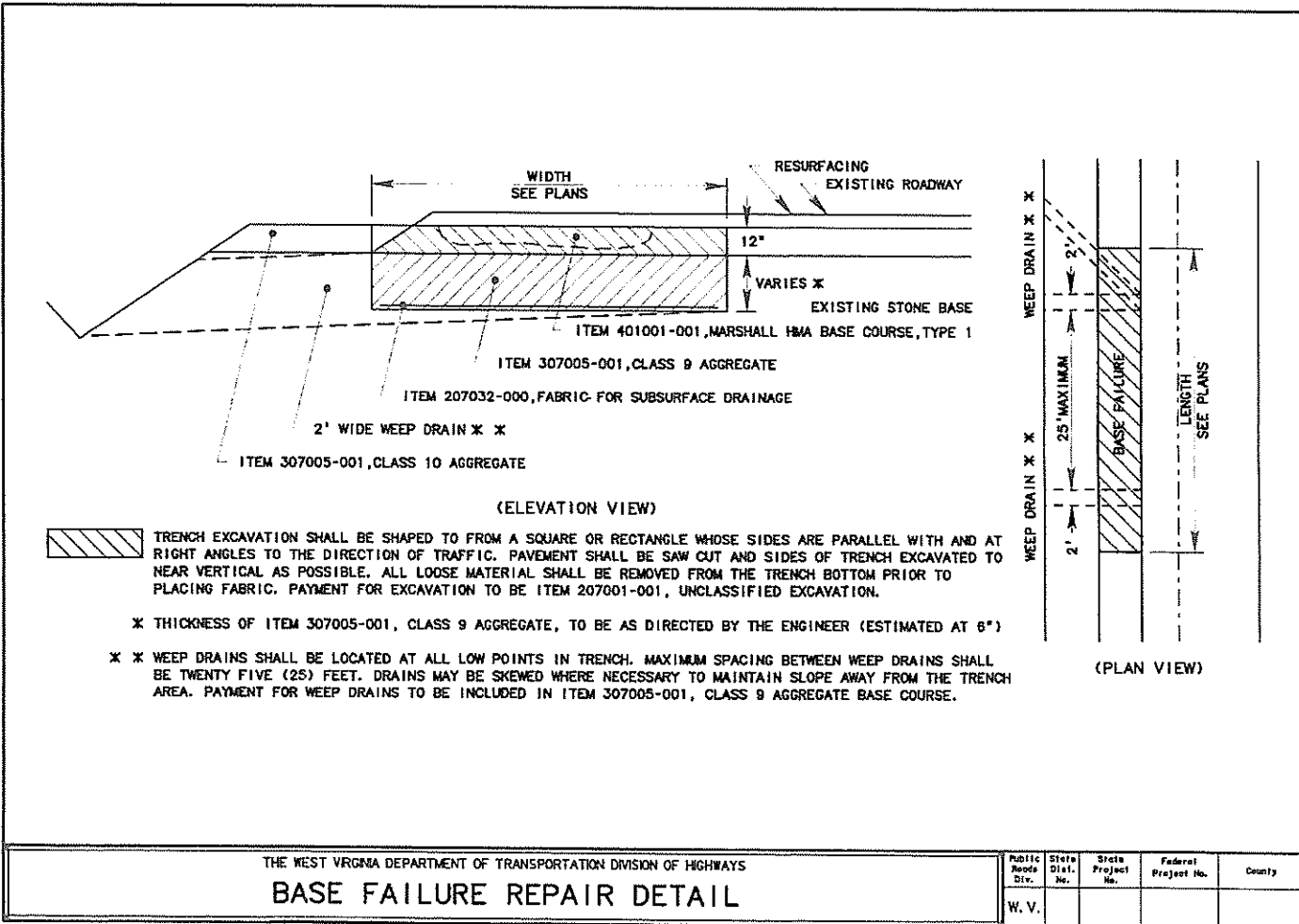

## Exhibit 1 - Edge Failure Repair Detail

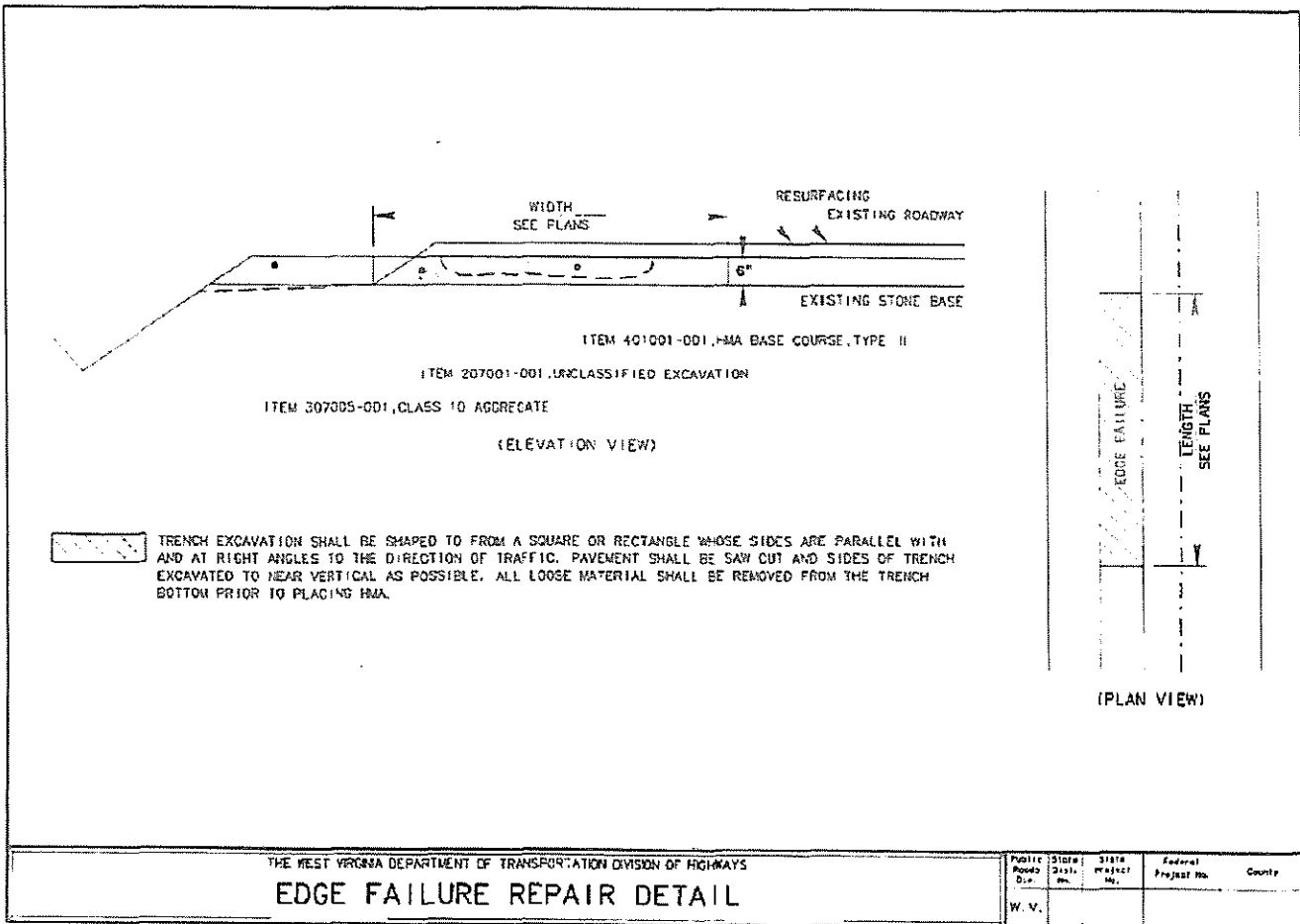

## Exhibit 1 - Pothole Repair Detail

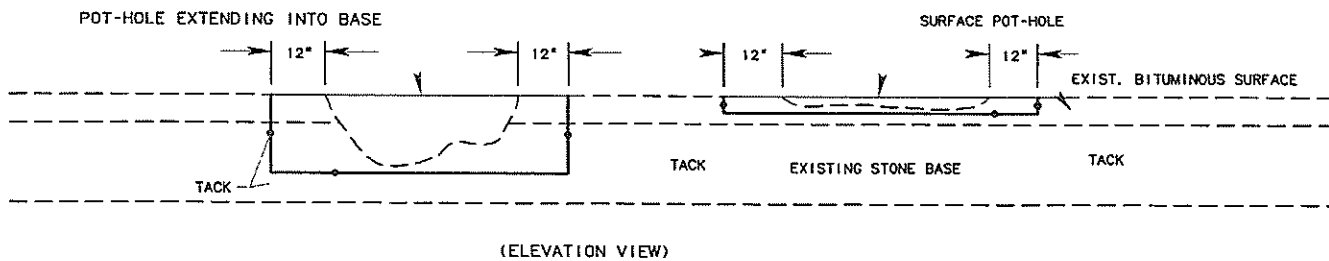

THE SIDES AND BOTTOMS MUST BE CLEANED AFTER THE HOLE IS SHAPED TO FROM A SQUARE OR RECTANGLE WHOSE SIDES ARE PARALLEL OR AT RIGHT ANGLES TO THE DIRECTION OF TRAFFIC WITH THE EDGES NEAT AND AS NEARLY VERTICAL AS POSSIBLE.

THE EXISTING BASE WILL BE REPLACED WITH HOT-LAID ASPHALT.

THE REMAINING SURFACE POT-HOLE WILL BE FILLED WITH HOT-LAID ASPHALT BASE COURSE TYPE MEETING REQUIREMENTS OF SECTION 401 OF THE SPECS. ENOUGH MATERIAL MUST BE USED TO BRING THE SURFACE OF REPAIR ABOUT 1/4" ABOVE THE LEVEL OF THE ORIGINAL PAVEMENT TO ALLOW FOR FURTHER COMPACTION BY TRAFFIC AND/OR RESURFACING.

THE WEST VIRGINIA DEPARTMENT OF TRANSPORTATION DIVISION OF HIGHWAYS

### POT - HOLE REPAIR DETAIL

Public Roads Div.	State Dist. No.	State Project No.	Federal Project No.	County
W. V.				

## Exhibit 1 - Rumble Strip Special Detail

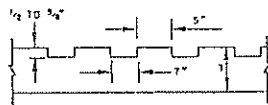

ALTERNATE SECTION B-B  
(SAWED RUMBLE STRIP)  
RUMBLE STRIP FOR HOT MIX ASPHALT SHOULDERS

**NOTES:**

RUMBLE STRIP PLACEMENT WILL BE DETERMINED BY THE CONTRACTOR'S SURVEYING DEPARTMENT, EXCEPT AS NOTED BELOW.

RUMBLE STRIPS SHALL NOT BE PLACED AT THE FOLLOWING AREAS FOR HIGHWAY PROJECTS ONLY:  
ON SHOULDERS OF HIGHWAY CLOSING LINES THAT ARE 5' OR LESS IN WIDTH, DUE TO TRAFFIC FLOW IN THE SHOULDER TRANSITION AREA, RIGHT OF TRAFFIC FLOW, BETWEEN A FULL PAVED SHOULDER WIDTH OF 10' AND HIGHWAY DRIVE WIDTH OF 4'.

RUMBLE STRIP WIDTH IS TO BE 2". EXCEPT MILLED RUMBLE STRIP WHICH WILL BE 10"-12".

RUMBLE STRIPS MAY BE SAWED OR MILLED UNLESS OTHERWISE NOTATED. THE TOP OF THE RUMBLE STRIPS WILL BE NO LOWER THAN THE TOP SURFACE OF THE PAVEMENT AND FACILITY OR IMPROPERLY INSTALLED RUMBLE STRIPS WILL BE CORRECTED BY THE CONTRACTOR AT HIS EXPENSE.

MILL/SAW SHOULDER RUMBLE STRIPS AS NOTATED BY USING A MACHINE CAPABLE OF PROVIDING A SMOOTH CUT WITHOUT LEAVING OR SHARPENED RUMBLE STRIPS AS REVEALED EDGE MARKING WITH GUIDES TO PROVIDE IMPROVED AND CONSISTENT ALIGNMENT OF EACH CUT WITH RESPECT TO ROADWAY AND SHOULDER RUMBLE STRIPS TO HAVE TRASH DEBRIS WITH TOLERANCE SPECIFIED AND CLEANED DURING STRIPS ON NEW CONCRETE SHOULDERS AFTER CORRECT ALIGNMENT OF PAVEMENT EDGE WILL BE RANDOMLY VERIFIED AND CHECKED IMMEDIATELY BEFORE OPERATION. IF SATISFACTORY RESULTS ARE NOT BEING OBTAINED AND SHOWN AN ALTERNATE CONSTRUCTION PLAN TO THE ENGINEER FOR APPROVAL. AT END OF EACH WORKING DAY, MOVE ALL EQUIPMENT TO A LOCATION AS DIRECTED WHERE IT PRESENTS NO HAZARD TO ROADWAY TRAFFIC REMOVE AND DISPOSE OF WASTE MATERIAL IN CONFORMANCE WITH APPLICABLE STATE REGULATIONS. REMOVE DEBRIS FROM AREAS INSTALLED BY MILLING OPERATION BEFORE OPENING ROADWAY TO TRAFFIC.

**RUMBLE STRIPS IN PAVED SHOULDERS:**

RUMBLE STRIPS SHALL BE MILLED OR SAWED TYPE PLACED IN SHOULDERS UNDER THE FOLLOWING CONDITIONS, IN ACCORDANCE WITH THIS SPECIAL DETAIL SHEET:

- TYPICAL SHOULDER WIDTH IS 0' OR MORE;
- NEARBY SHOULDERS OR DIVERTED HIGHWAYS, IF SHOULDER WIDTH IS 3' OR GREATER;
- SHOULDERS ADJACENT TO THE WAY DOWNS WHICH CONNECT TO NATIONAL HIGHWAYS, IF TYPICAL SHOULDER IS 3' OR GREATER.

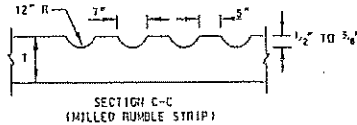
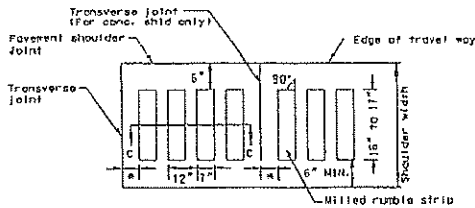

\* 1 1/2" For conc. shld.  
2 1/2" For asphalt shld.

MILLED RUMBLE STRIP FOR PORTLAND CEMENT AND HOT MIX ASPHALT SHOULDERS

THE WEST VIRGINIA DEPARTMENT OF TRANSPORTATION DIVISION OF HIGHWAYS

## RUMBLE STRIP SPECIAL DETAIL

## Exhibit 1 - Base Failure - Partial Width Detail

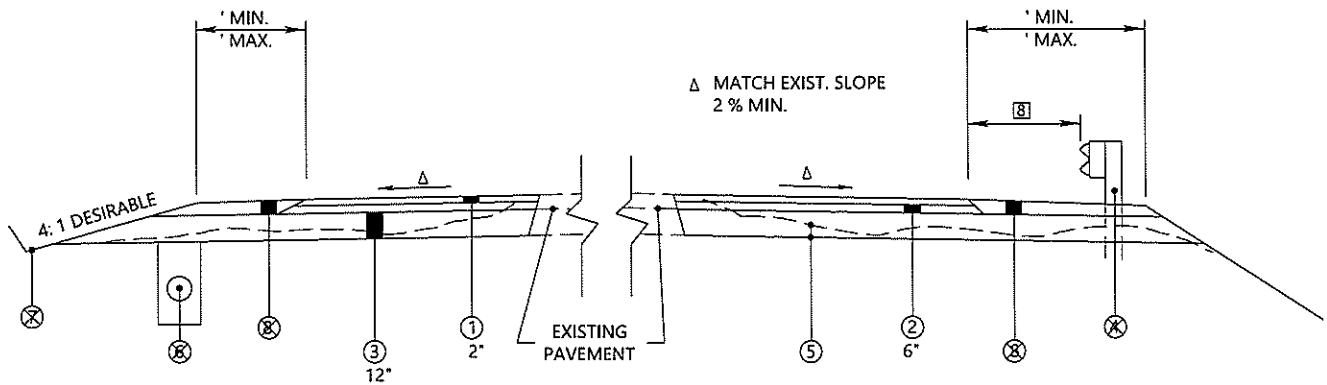

**LEGEND**

- ① ITEM 401002-020, MARSHALL ASPHALT WEARING COURSE, STONE OR GRAVEL, TYPE I OR  
ITEM 401002-021, MARSHALL ASPHALT WEARING COURSE, SLAG, TYPE I
- ② ITEM 401001-020, MARSHALL ASPHALT BASE COURSE, STONE OR GRAVEL, TYPE I OR  
ITEM 401001-021, MARSHALL ASPHALT BASE COURSE, SLAG, TYPE I
- ③ ITEM 307001-000, AGGREGATE BASE COURSE, CLASS 1
- ~~④ ITEM 607001-001, TYPE I GUARDRAIL, CLASS I~~
- ⑤ ITEM 207001-001, UNCLASSIFIED EXCAVATION
- ~~⑥ ITEM 606025 \_\_\_\_\_ INCH UNDERDRAIN PIPE OR  
ITEM 606020-001 FABRIC UNDERDRAIN, AS SPECIFIED IN PLANS~~
- ~~⑦ ITEM 229001-001, SHOULDERS AND DITCHES (SEE DETAIL PAGE 20)~~
- ~~⑧ ITEM 307005-001, AGGREGATE BASE COURSE, STONE OR GRAVEL, CLASS 10 OR  
ITEM 307005-002, AGGREGATE BASE COURSE, SLAG, CLASS 10~~

**NOTES:**

The pavement design for this project shall be in accordance with \_\_\_\_\_ Traffic Design. The design ESAL value on this project shall be \_\_\_\_\_.

GUARDRAIL TO BE LOCATED AT THE PREVAILING OFFSET IN ADJACENT SECTIONS.

THE WEST VIRGINIA DEPARTMENT OF TRANSPORTATION DIVISION OF HIGHWAYS

# TYPICAL SECTION FOR BASE FAILURE-PARTIAL WIDTH

Public Roads Div.	State Dist No.	State Project No.	Federal Project No.	County
W.V.				





**WEST VIRGINIA DEPARTMENT OF TRANSPORTATION  
DIVISION OF HIGHWAYS  
DESIGN DIRECTIVE**

**DD-650  
PAVEMENT SAFETY EDGE**  
*January 10, 2012*

This Design Directive provides all designers with the West Virginia Department of Transportation (WVDOT), Division of Highways' (DOH) policy for providing a "safety edge" on all pavements meeting the required criteria.

## 10. General

Roadway Departure, in which a vehicle unintentionally departs its lane and either runs off the roadway, crosses the centerline or median, goes airborne, or hits a fixed object is the leading cause of fatalities on West Virginia roadways. Approximately 70% of all roadway fatalities are attributed to roadway departure in West Virginia.

Pavement edge drop-offs are a recurring problem between the pavement and the graded material that makes up the shoulder or roadside. Paved shoulders increase the chance of recovery but do not reduce the occurrence of drop offs from the shoulder to the roadside. Research has shown that even small drop-offs can create problems for drivers attempting to recover.

The Safety Edge is a simple, low cost technique that can make an edge drop-off significantly safer. The safety edge provides the driver with greater ease in returning the vehicle to the roadway, and reduction of the risk of over-steering and possible loss of control of the vehicle. With the safety edge in place, any interference in driving across any drop-off between the pavement edge and shoulder is mitigated by the slope of the safety edge, preventing tire “scrubbing” and thus providing errant drivers more opportunity to regain control of their vehicle and either avoid or lessen the severity of a crash.

## 20. Criteria for Use

The safety edge will be required on all NHS highway routes, and all routes designated “arterial” and “collector” in accordance with DD-601. It is to be used on both asphalt and concrete pavements unless the roadway or shoulder is curbed or is bounded by a barrier such as a single-slope barrier (usually in the median of 6-lane (or more) expressways and Interstate highways, but can be at the edge of the shoulder in certain applications). The Safety Edge is recommended for all other designated roadways in accordance with DD-601.

On overlay projects, Safety Edge is recommended if the total overlay thickness (scratch excluded) is 1.5” or greater. Safety Edge will not be placed if total overlay thickness is less than 1.5”. In addition, if overlay project involves milling and replacing in kind on mainline only (commonly referred to as “mill and fill” projects), then Safety Edge will not be utilized.

## 30. Design and Plan Requirements

The angle of the bevel from the slope of the pavement is critical for the safety edge to function properly. Measured from the cross slope of the pavement, the required angle ranges from 30 to 35 degrees.

**For pavements with safety edge, shoulder aggregate shall be placed and maintained to the top of the pavement elevation.**

In areas where the shoulder is soft and cannot be compacted, or for other reasons it cannot provide support for the safety edge, widening of the pavement shall be provided to support the edge. Field investigations should be made to check for any condition that will not support the safety edge. However if this condition exists at locations where the shoulder is non-existent and the edge of pavement is at the top of a roadside ditchline, the outside point of the safety edge (the toe) should be placed at the original edge of pavement, with the edge stripe at the safety edge's breakpoint. The designer must use sound engineering judgment when resurfacing existing roadways regarding the location of the new edge of pavement, placement of the safety edge, and any pavement widening.

When safety edge is required, it will be detailed on the typical sections. If there are any areas where the edge is not required or cannot be placed, limiting stations will also be given.

The following sketches are not to scale and represent a schematic detail for the purpose of showing configurations and dimensions only. Also, the free-draining base course trench may not be located as shown in these sketches.

#### A. Asphalt Pavement and Overlays

For projects bid in Tons (Megagrams) the asphalt quantity will be the actual quantity computed, including the safety edge. Note that the safety edge can be constructed on each lift of asphalt.

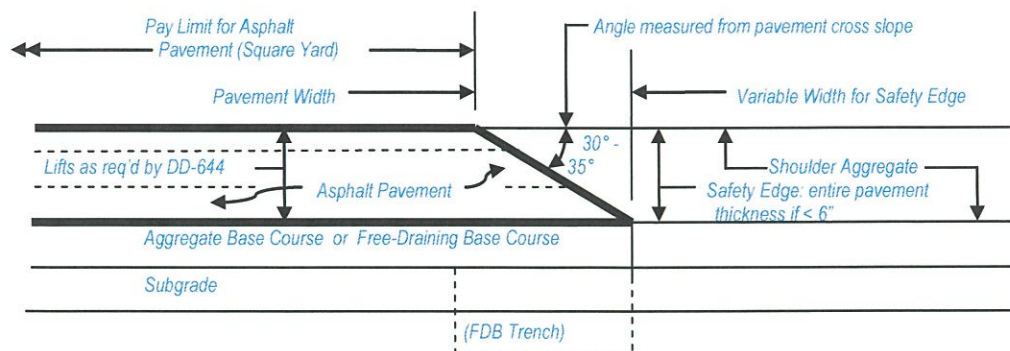

**Safety Edge Dimensions for Asphalt Pavement (New Construction < 6" thickness)**

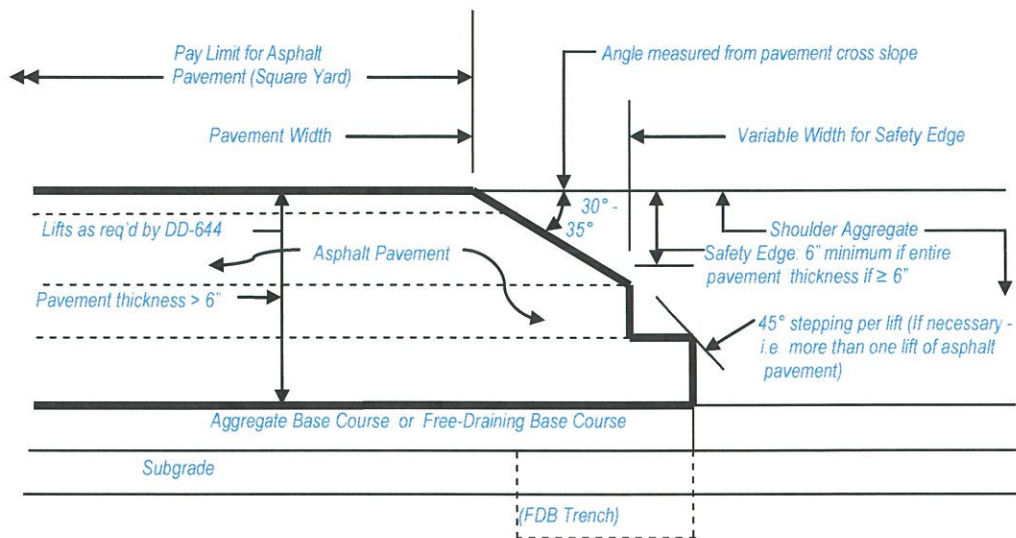

**Safety Edge Dimensions for Asphalt Pavement (New Construction  $\geq 6''$  thickness)**

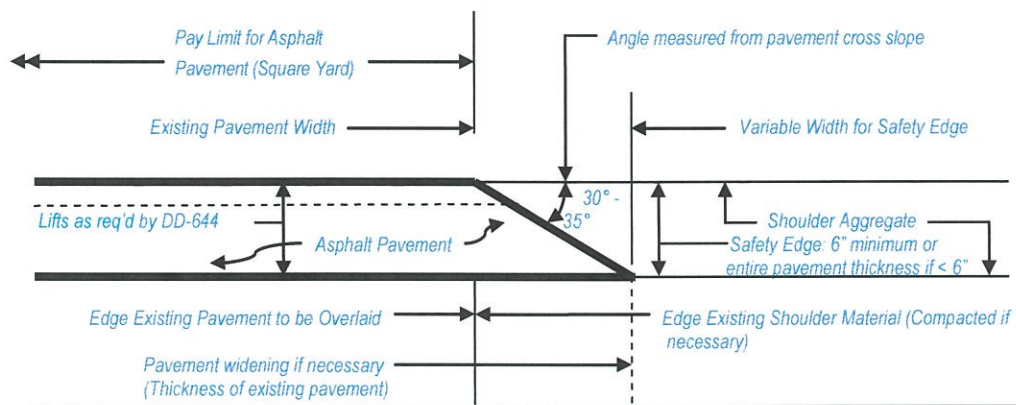

**Safety Edge Dimensions for Asphalt Pavement (Overlay – for Roadways with Established Design Criteria, i.e. Interstate, APD, NHS and US Routes)**

**B. Concrete Pavement and Overlays**

The sloped portion of the safety edge is to be 6” minimum in vertical height. To allow proper finishing by a slip-form paver, a minimum 2” vertical face is required at the bottom outside of the safety edge.

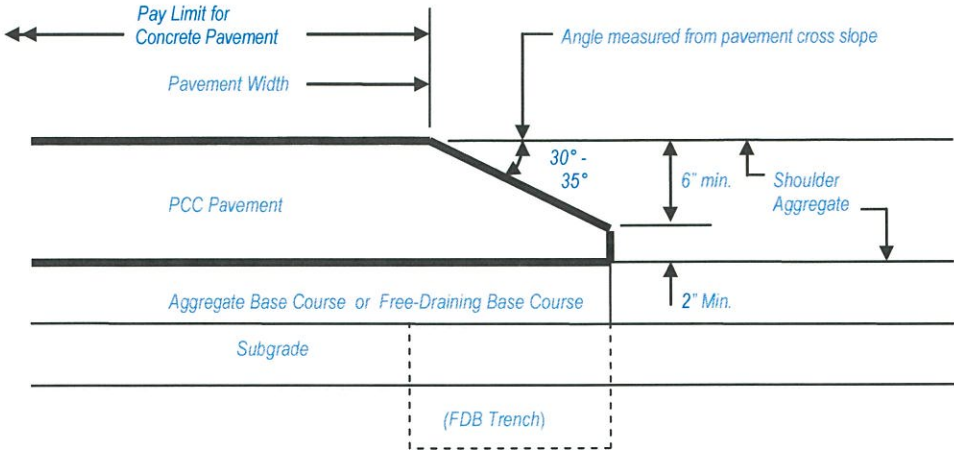

**Safety Edge Dimensions for Concrete Pavement (New Construction)**

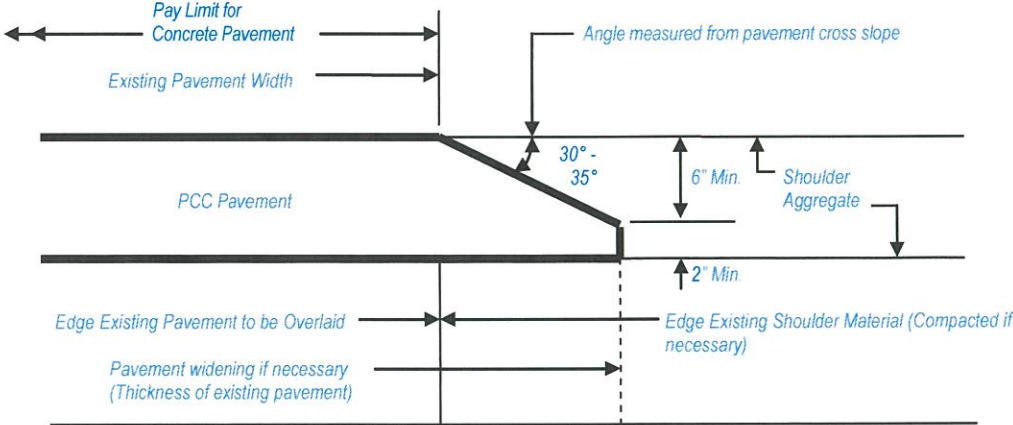

**Safety Edge Dimensions for Concrete Pavement Overlay – for Roadways with Established Design Criteria, i.e. Interstate, APD, NHS and US Routes)**

**WEST VIRGINIA DEPARTMENT OF TRANSPORTATION**

**DIVISION OF HIGHWAYS**

**SPECIAL PROVISION**

**FOR**

**STATEWIDE ASPHALT MATERIALS, DELIVERY**

**& LABOR BY VENDOR BY COUNTY**

**CONTRACT 6624C018, EXHIBIT 3**

**SECTION 401**

**ASPHALT BASE, WEARING, AND PATCHING AND LEVELING  
COURSES**

ADD THE FOLLOWING SUBSECTION TO THE SECTION:

**401.4.3-Increase of Reclaimed Asphalt Pavement (RAP) in Asphalt Concrete Mixes:** This Special Provision has been written to address the use of increased amounts of reclaimed asphalt pavement (RAP) used within mixes produced for projects in the WVDOH construction program.

The increased use of RAP can become an effective measure to help reduce overall construction costs and ultimately allow the WVDOH to treat more mileage within the established annual budgets. This will also allow the WVDOH to accomplish savings while at the same time, doing so in an environmentally responsible manner. However, it is important that any steps taken to use increased amounts of RAP be performed in a manner that will also not be detrimental to the quality of the asphalt concrete mixes produced.

The WVDOH will allow the increased use of RAP in Marshall Base 1 and Base 2, and Superpave 19 mm, 25 mm, and 37.5 mm mixes up to 25%. Initially, all mix designs shall be submitted in accordance to MP 401.02.24, with the exception that Section 5.0, Line 5.4 pertaining to RAP contents between 16% and 25% will be waived. The addition of up to 25% RAP will be allowed in Marshall Base 1, and Superpave 25 mm and 37.5 mm mixes for all applications provided that the processing of RAP is consistent with that discussed for State Funded projects below. For Marshall Base 2 and SP 19 mm, the following criteria shall be used for acceptance during production:

**401.4.3.1-Interstates, APD Corridors, and Multilane Roadways:**

- a) **Superpave 401 projects with PWL factors:** 25% RAP Base 2 or SP 19mm will be allowed.
- b) **All other projects will require one random loose roadway sample per 1000 ton placed.** Samples will be taken generally as per MP 401.07.21, by the Contractor along with WVDOH personnel. Each sample then will be tested by the Contractor in order to determine AC and gradation, and all such testing shall be witnessed by the WVDOH. The contractor must have an established ignition oven correction factor for both AC Content and gradation for each mixture. In addition this correction factor must be established prior to the project and will only be valid during the paving season it was established. All



sample results for AC and Gradation shall then be evaluated for additional pay factors as per Table 401.13.3.1 of the SP 401 Square Yard PWL, then applied in the formula shown below. The results for AC and gradation (minus #200) from QC samples at the plant will not be used for determination of pay adjustment. A lot will be 5,000 tons or portion thereof with a minimum of three samples. Portions less than 2,000 tons shall be incorporated into the previous lot. There will be no incentive for PWL from 96 to 100.

$$\text{Pay Deduction per Ton or SY (\%)} = \frac{100 - [(PF_{AC} + PF_G) / 2]}{2}$$

**401.4.3.2-Other Federal Aid and NHS routes:**

- a) WVDOH will monitor plant QC Samples for AC and gradation for the mix being produced. The contractor must have an established ignition oven correction factor for both AC Content and gradation for each mixture. In addition this correction factor must be established prior to the project and will only be valid during the paving season it was established. These results shall then be evaluated for additional pay factors as per Table 401.13.3.1 of SP 401 Square Yard PWL, and then applied in the formula shown below. A lot will be five samples or portion thereof with a minimum of three samples. Testing frequency shall be a minimum of 1 sample per 1,000 tons of daily production (maximum of 750 tons for adjusted sublots) and shall include gradation and AC content for each sample. There shall be at least one sample per day of production. Lots may cover more than one project, but no more than three. Any penalties calculated shall be applied to all the material represented by the testing of the evaluated lot. Portions less than two samples shall be incorporated into the previous lot. There will be no incentive for PWL from 96 to 100.

$$\text{Pay Deduction per Ton or SY (\%)} = \frac{100 - [(PF_{AC} + PF_G) / 2]}{2}$$

**401.4.3.3-State Funded Projects (including Marshall Wearing IV or Superpave 19mm may be used as surface mix on routes with ADT below 3000):**

- a) Process for addition of RAP shall include initial scalping to remove + 3/4" (19 mm) material and proper stockpile management in accordance with Best Practices for RAP Management as documented by NCHRP report 752, Appendix D, and as discussed in Publication No. FHWA-HRT-11-0-21. These documents can be accessed at the respective links below:

[http://onlinepubs.trb.org/onlinepubs/nchrp/nchrp\\_rpt\\_752.pdf](http://onlinepubs.trb.org/onlinepubs/nchrp/nchrp_rpt_752.pdf)

<http://www.fhwa.dot.gov/publications/research/infrastructure/pavements/11021/11021.pdf>

The submission of mix designs shall be done in the same manner as described for Marshall Base 2/Superpave 19 mm above and production shall be monitored as described above for other Federal Aid or NHS Routes.



**WEST VIRGINIA DEPARTMENT OF TRANSPORTATION**  
**DIVISION OF HIGHWAYS**  
**SPECIAL PROVISION**  
**FOR**  
**STATEWIDE ASPHALT MATERIALS, DELIVERY**  
**& LABOR BY VENDOR BY COUNTY**  
**CONTRACT 6624C018, EXHIBIT 4**

**SECTION 496**  
**ASPHALT HIGH PERFORMANCE THIN OVERLAY**

**496.1-DESCRIPTION:**

This work shall consist of constructing a single course of an asphalt high performance thin overlay (HPTO), mixed mechanically in a plant, composed of aggregate and asphalt material designed in accordance with the Superpave Design System, on a prepared foundation in accordance with these specifications and in reasonable close conformity with the lines, grades, weights or thicknesses, and cross sections shown on the Plans or established by the Engineer.

The unit of measurement for HPTO will be either by the ton (megagram) or square yard (square meter).

The work will be accepted in accordance with these Specifications and the applicable requirements of Sections 105, 106, and 109.

**496.2-MATERIALS:**

The materials shall conform to the following requirements:

<b>MATERIAL</b>	<b>SUBSECTION</b>
Coarse Aggregate <sup>Note-1 &amp; 2</sup>	703.1 thru 703.3 (See MP 401.02.28 for exceptions and additions required for Superpave aggregates)
Fine Aggregate <sup>Note-2</sup>	702.3 (See MP 401.02.28 for additions required for Superpave aggregates)
Mineral Filler	702.4
Non-Tracking Asphalt Material	705.13
PG 64E-22 Performance Graded Binder for Mixture	705.5

MATERIAL	SUBSECTION
PG 64S-22 Performance Graded Binder for Tack Coat	705.5

**Note-1:** The total coal and other lightweight deleterious material and friable particles shall not exceed 1.0%.

**Note-2:** All aggregate shall be 100% crushed and come from a source identified as approved for polish resistant aggregate meeting the requirements of Section 402

### CONSTRUCTION METHODS

**496.3-GENERAL:**

Construction methods to be used in performing the work shall be submitted to the Engineer for review prior to the start of work. This review may require modification of the proposed methods to provide the desired end product. All equipment, tools, machinery, and plant shall be maintained in a satisfactory working condition.

**496.4-COMPOSITION OF MIXTURES:**

**496.4.1-General:** The aggregate for use in the designated mixture shall consist of a mixture of aggregate (coarse and fine) and mineral filler as required. Reclaimed asphalt pavement (RAP) shall not be used in a HPTO mix.

**496.4.2-Job Mix Formula:** The Job Mix Formula (JMF) is the specification for a single mix produced at a single plant. This mix may be specific to a single project or be used on multiple projects if the basic design criteria (aggregate gradation, design compaction level and PG Binder grade) are the same.

The Contractor shall submit a proposed JMF for each combination of aggregate and asphalt material for HPTO to be produced. The JMF gradations shall be within the tolerances set forth in Table 496.4.2A.

The HPTO design shall be developed using the guidelines of MP 401.02.28, with the exception that the volumetric properties shall meet the requirements of Table 496.4.2B. The percent voids-filled-with-asphalt (VFA) requirement of the MP shall be waived.

Each proposed JMF must be documented on the Division Form T400SP and the entire JMF package shall be forwarded for review to the District Materials Engineer/Supervisor. After review and verification of completeness the T400SP and JMF package shall then be forwarded to the Materials Control, Soils and Testing Division (MCS&T) for final review. If the JMF requires revision, it will be returned to the designer through the District. The T400SP Form shall contain the following information:

- i. Identification of the source and type of materials used in the design.
- ii. The aggregate blend percentages and the percentage for each sieve fraction of aggregate considered the desirable target for that fraction.
- iii. The percentage of asphalt binder representing the optimum asphalt content for the JMF submitted, which is to be considered the desirable target percentage.

- iv. The temperature of the completed mixture at the plant which shall be within  $\pm 25$  °F ( $\pm 14$  °C) of the median mix temperature established by the temperature-viscosity chart or as recommended by the asphalt supplier.
- v. The ratio (calculated to the nearest one-tenth percent) of the fines to effective asphalt.
- vi. The amount and type of anti-strip agent, if used.

Standard Sieve Size	Percent Passing
1/2 in. (12.5 mm)	100
3/8 in. (9.5 mm)	90-100
No.4 (4.75 mm)	95 max
No.8 (2.36 mm)	30-60
No.16 (1.18 mm)	25-40
No.30 (600 $\mu$ m)	15-30
No.50 (300 $\mu$ m)	10-25
No.100 (150 $\mu$ m)	5-15
No. 200 (75 $\mu$ m)	4-12
Asphalt Content	7.0 Min

**TABLE 496.4.2B**

<b>Design Volumetric Property Requirements for HPTO Mix Design</b> <sup>Note-3</sup>	
<b>Design Criteria</b>	<b>Ndesign</b>
Number of Design Gyration	50
Air Voids (%)	3.0
Voids-in-Mineral Aggregate (%)	18.0 minimum
Fines-to-Effective Asphalt Ratio	0.6-1.2
Tensile strength ratio (AASHTO T283) <sup>Note-3</sup>	85% minimum

**Note 3:** If the tensile strength ratio (TSR) is less than 85% without an anti-stripping agent, then an anti-stripping agent may be added and the mixture retested. If retesting with the agent still produces a TSR of less than 85% then a new mix design will be required.

If it becomes necessary to change aggregate sources, a new mix design shall be developed and submitted for approval. The source of the polymer modified binder may only be changed if the source is another facility owned and operated by the same company as the original source. The new facility shall submit verification that the binder is produced in the same manner and with the same grade and amount of polymer material as the original source. They shall also verify that the blending of the two binders in the same storage tanks will not have an adverse effect on the properties of the binder grade in use.

**496.5-TESTING:**

**496.5.1-Test Methods:** Test methods shall be those listed in Section 401.5.1.

**496.6-CONTRACTORS QUALITY CONTROL:**

**496.6.1-Quality Control Testing:** Quality control of HPTO is the responsibility of the Contractor. The Contractor shall maintain equipment and qualified personnel including at least one certified HMA asphalt technician at each plant. The technician shall be in charge of all plant quality control activities such as mix proportioning and adjustment and all sampling and testing activities necessary to maintain the various properties of HPTO within the limits of the specification.

The Contractor shall maintain equipment and qualified personnel including at least one certified Compaction Technician at each project. A certified Compaction Technician shall perform all testing necessary to assure compaction of the HPTO meets specification requirements. The Contractor, or Contractor-Producer, shall design a workable Quality Control Plan, detailing the type and frequency of sampling and testing deemed necessary to measure and control the magnitude of the various properties of the HPTO governed by these Specifications. This plan, prepared in accordance with MP 401.03.50 shall be submitted to the Engineer for review prior to production of material under this Specification.

**496.6.2-Quality Control Testing Requirements:** Test requirements for quality control shall be as set forth in MP 401.02.29, with the exception that the job mix formula field design verification and quality control testing for HPTO shall be monitored for conformance to the mix property requirements of Table 496.6.2. Additionally, the minimum quality control sampling frequency shall be one random sample per every 750 tons of HPTO mixture delivered to the project. In order to evaluate conformance to the specifications using MP 401.02.29, all job mix formula field design verification and quality control samples obtained for the project shall be used in the moving average calculations and the final evaluation of all test data shall be project specific.

**TABLE 496.6.2**

<b>Quality Control Mix Property Tolerances</b>	
<b>Property</b>	<b>Production Tolerances</b>
Asphalt Content (%)	JMF ± 0.3 %
Air Voids (%)	2.0 to 4.0 %
Voids in Mineral Aggregate (VMA) %	≥ 18.0%
% Passing No. 8 (2.36 mm) Sieve	JMF ± 4
% Passing No. 200 (75 µm) Sieve	JMF ± 2.0

**496.7-ACCEPTANCE TESTING:**

**496.7.1-Acceptance Testing of HMA:** Acceptance testing of HPTO is the responsibility of the Division. The acceptance sampling and testing requirements for the mixture shall be as set forth in MP 401.02.29, with the exception that the HPTO shall be monitored for conformance to the mix property requirements of Table 496.6.2.

**496.7.2-Compaction:** Acceptance testing for compaction shall be performed in accordance with the Lot-by-Lot method described in Section 496.7.2.1. Any patching-and-leveling and scratch courses placed prior to the placement of the HPTO shall be compacted to the satisfaction of the Engineer. When HPTO is placed in areas that require a nonuniform

thickness or is tapered to a thin edge, the method of acceptance testing shall be determined by the Engineer. Acceptance testing is not required on areas in which a full-size roller is restricted from properly compacting the mat. These areas shall be compacted to the satisfaction of the Engineer.

**496.7.2.1-Lot-By-Lot Testing:** Randomly located nuclear density tests will be performed in accordance with the Lot by Lot test procedure as described in MP 401.05.20. The pavement shall be divided into Lots not exceeding 1000 feet (300 meters) of paving lane. A randomly located density test shall be conducted in each Lot. The density shall be monitored for conformance to the range of 94% to 97% of the maximum density of the approved mix design. If the density is outside the range, an additional five tests shall be conducted for the Lot and the average of these five tests used to judge acceptance of the Lot in accordance with Table 496.13.3A.

**496.8-WEATHER RESTRICTIONS:**

HPTO shall not be placed on a wet surface or when the surface temperature of the underlying course is less than 50 °F (10 °C).

**496.9-EQUIPMENT:**

**496.9.1-Plants:** Shall meet the requirements of Sections 401.9.1.

**496.9.2-Dust Collector:** Shall meet the requirements of Sections 401.9.2.

**496.9.3-Truck Scales:** Shall meet the requirements of Sections 401.9.3.

**496.9.4-Test Weights:** Shall meet the requirements of Sections 401.9.4.

**496.9.5-Surge and Storage Bins:** During the normal daily operation of the plant, HPTO may be stored in a surge or storage bin for a maximum of 4 hours, provided the bin has received prior evaluation and acceptance through the District plant inspection. The temperature of the material at time of placement and compaction shall be sufficient to properly perform these activities.

Loading of trucks through the storage bin will only be permitted when a minimum 25 ton (23 Mg) buffer of material is being maintained or an amount as recommended by the bin manufacturer. Means shall be provided for loading the trucks directly from the mixer when the storage bin is not in operation.

**496.9.6-Inspection of Equipment and Plant Operations:** Shall meet the requirements of Sections 401.9.6.

**496.9.7-Trucks for Transporting Mixture:** Shall meet the requirements of Sections 401.9.7.

**496.9.8-Laboratory:** Shall meet the requirements of Sections 401.9.8.

**496.9.9-Spreading Equipment:** Shall meet the requirements of Sections 401.9.9.

**496.9.10-Compaction Equipment:** Shall meet the requirements of Sections 401.9.10.

**496.9.11-Materials Transfer Vehicle:** Provide and use a Material Transfer Vehicle (MTV) to place asphalt mixtures. The MTV shall include a system in the storage bin to continuously blend the asphalt mixture prior to discharge, and a system to independently deliver asphalt mixtures from the hauling equipment to the paving equipment. It shall also have a high capacity truck unloading system, capable of 600 tons per hour, that will receive asphalt mixtures from the hauling equipment, and have a minimum combined capacity, including the MTV storage bin and paver hopper, of 15 tons of asphalt mixture. Additionally, the MTV should have a discharge conveyor, with the ability to swivel and deliver the mixture to the paving spreader while allowing the MTV to operate from an adjacent lane.

**496.10-PAVING OPERATIONS:**

**496.10.1-Cleaning and Sweeping:** Shall meet the requirements of Sections 401.10.1.

**496.10.2-Patching and Leveling and Scratch Courses:**

**496.10.2.1-Patching and Leveling:** Shall meet the requirements of Sections 401.10.2.1. When patching and leveling is used, a PG 64S-22 tack coat or approved Non-Tracking Asphalt Material shall be applied to the existing pavement sections being patched in accordance with Section 496.10.3 prior to placement.

**496.10.2.2-Scratch Course:** Scratch course should not be used on most projects, but if it is used, it shall meet the requirements of Sections 401.10.2.2. When scratch course is used, a PG 64S-22 tack coat or NTSS-IHM shall be applied to the existing pavement in accordance with Section 496.10.3 prior to placement.

**496.10.3-Spreading and Finishing:** Before spreading any HPTO, a hot tack coat of PG 64S-22 or Non-Tracking Asphalt Material shall be applied to the existing surface according to Section 408. The contact surfaces of curbs, gutters, manholes, and of adjacent Portland cement concrete pavement edges shall be painted or sealed with the same tack coat material. When precipitation has occurred during the previous 24 hours, the engineer will determine if the tack coat may be applied or if the work will be delayed until the surface is completely dry. No more tack coat shall be applied than can be covered in the same day. Traffic control shall be provided to prevent vehicles from riding on surfaces upon which tack coat has been applied. The PG 64S-22 tack coat shall be applied at a rate of 0.05 – 0.12 gal/yd<sup>2</sup> (0.23 – 0.54 L/m<sup>2</sup>) and at a spraying temperature of approximately 325 °F (163 °C). Non-Tracking Asphalt Material shall be applied at a rate to produce a residual rate of 0.05 - 0.12 gal/yd<sup>2</sup> (0.23 – 0.54 L/m<sup>2</sup>) and shall be applied at a temperature of approximately 170 °F (77 °C). The spraying temperature and application rate will be adjusted by the Engineer as required to produce a uniform coating so that every part of the surface is covered, with no excess material. All uncoated or lightly coated areas shall be corrected. All areas showing an excess of asphalt binder shall be corrected by removing the excess material. The application is not acceptable if the material is streaked or ribboned.

The HPTO mixture shall meet the temperature requirements recommended by the asphalt supplier which will be referenced on the JMF. The mix temperature shall be monitored by inserting a dial type thermometer into the mix through a hole in the truck bed. The mixture shall not be placed if the temperature is below 265 °F (130 °C).

The temperature of the completed mix, when measured at the plant, shall be within the tolerance as established by the JMF. The first load, which demonstrates temperatures outside of that range shall be accepted provided that the temperature is still within the master temperature range. Any truckload of material which exceeds the master temperature range may be rejected by the Engineer. No additional loads of material shall be run out until necessary steps are taken to reestablish the temperature of the mix within the plant tolerance. When measured at the project site, the temperature of the mix shall be within the tolerance established by the JMF. The first truck load of material which demonstrates temperatures outside of that range or any trucks in transit at that time shall be accepted provided the temperature is not below 265 °F (130 °C). Any truckload of material which exceeds the JMF temperature range and/or is below 265 °F (130 °C) shall be rejected by the Engineer. The plant shall immediately be notified that no additional loads of material are to be dispatched until necessary action is taken to reestablish temperature within JMF specification limits.

The Contractor shall monitor the surface temperature at a minimum of once every hour. When the surface temperature begins dropping toward the 50 °F (10 °C) minimum temperature for placement, temperature monitoring shall increase to a minimum of once every ½ hour. Placement shall be halted when the surface temperature drops below 50 °F (10 °C).

The placement of all HPTO material at the job site shall be accomplished using a Materials Transfer Vehicle as discussed in 496.9.11.

**496.10.4-Rolling Procedure:** Shoulders, ramps, and similar areas shall be compacted in the same method as the mainline.

During rolling, roller wheels shall be kept moist with only enough water to avoid picking up material. Fuel oil or other petroleum products are not allowed on roller wheels or pneumatic tires. Rollers shall move at a slow but uniform speed with the drive roll or wheels nearest the paver. The sequence of rolling operations and the type of rollers used shall be at the discretion of the Contractor. A sufficient number of rollers shall be furnished to handle the output of the plant.

If rolling causes material displacement, the affected area shall be loosened at once with lutes or rakes and restored to their original grade with loose material before being re-rolled. Heavy equipment, including rollers, should not be permitted to stand on the finished surface before it has thoroughly cooled or set.

Any mixture that becomes loose and broken, mixed with dirt, contains check-cracking, or in any way defective shall be removed and replaced with fresh HPTO mixture and immediately compacted to conform to the surrounding area at the Contractor's expense.

**496.10.5-Joints:** The formation of all joints shall be made in such a manner as to ensure a continuous bond between the courses and obtain the required density. All contact surfaces shall be given a tack coat of asphalt binder prior to placing any fresh mixture against the joint.

The longitudinal joint in any layer shall offset that in the layer immediately below by approximately six inches; however, the joint in the top layer shall be at the centerline of the pavement if the roadway comprises two lanes of the width, or at lane lines if the roadway is

more than two lanes in width. The transverse joint in any layer shall offset that in the layer immediately below by approximately six feet.

All transverse joints between existing and new pavement shall be "heeled-in" to the existing surface at the beginning and at the end of the project and at all other locations where the new pavement terminates against an existing pavement. Transverse joints between one day's production and the next shall be carefully constructed and shall be formed by cutting back into the existing section to expose the full depth of the course. All joints shall be squared up to the full vertical depth of the course to be placed, and a tack coat of asphalt material shall be applied. Joints adjacent to curbs, gutters, or adjoining pavement shall be formed by transporting back sufficient hot material to fill any space left uncovered by the paver.

Longitudinal joints which are irregular, damaged, un-compacted, or otherwise defective shall be cut back to expose a clean, sound surface for the full depth of the course. The longitudinal joint between adjacent mats shall be set up to a sufficient height to receive the full compactive effort from the rollers and shall be tacked prior to placing adjacent material. Transverse joints shall be checked for smoothness with a ten foot straight edge provided by the Contractor. All surface irregularities shall be corrected prior to proceeding with paving operations.

**496.11-PROTECTION OF PAVEMENT AND TRAFFIC CONTROL:** Shall meet the requirements of Sections 401.11.

**496.12-METHOD OF MEASUREMENT:**

HPTO will be measured by the ton (Mg), or square yard (square meter). If the project is to be paid by the ton, the quantity will be determined by the Contractor from the total weight slips for each vehicle load weighed upon an approved standard scale or from digital printout slips from an automatic batching plant, and certified by the Contractor as correct. If the project is to be paid by the square yard, the quantity will be determined by the Plan Quantity as provided for in the proposal unless otherwise directed by the Engineer.

Any patching or leveling mixture placed on a subbase or base course constructed in the same Contract with the HPTO item shall be at the expense of the Contractor. No additional compensation will be allowed for the material or any work incidental to its placement.



**496.13-BASIS OF PAYMENT:**

The quantities determined as provided above, will be paid for at the contract unit price for the items listed below, which prices and payment shall be full compensation for furnishing all the materials and doing all the work herein prescribed in a workmanlike and acceptable manner, including all labor, tools, equipment, field laboratory, supplies, and incidentals necessary to complete the work.

When a Lot of HMA pavement does not meet the density requirements of 496.7.2, the price shall be adjusted as follows:

**Formula 1:** Projects requiring only mat density testing:

$$\text{Lot Price Adjustment (Mat only)} = (\text{unit price}) \times (\text{Lot quantity}) \times (\text{mat density price adjustment \% from Table 496.13.3A})$$

**Formula 2:** Projects requiring both mat and joint density testing:

$$\text{Lot Price Adjustment (Mat + Joint)} = (\text{unit price}) \times (\text{Lot quantity}) \times [(\text{mat density price adjustment \% from Table 496.13.3A}) + (\text{joint density price adjustment \% from Table 496.13.3B})]$$

**TABLE 496.13.3A**

<b>Adjustment of Contract Price for Pavement Mat Density Not Within Tolerance</b>	
<b>Percent of Mat Density</b>	<b>Percent of Contract Price To Be Paid</b>
Greater than 97 %	Note 1
96% to 97%	102
94 % to 96 %	100
93 %	98
92 %	96
91 %	92
90 %	88
Less Than 90 %	Note 2

**Note 1:** Mat density slightly above 97% is normally only a problem if it leads to asphalt flushing on the surface of the mat or rutting due to an unstable mix. The Division will make a special evaluation of the material and determine the appropriate action.

**Note 2:** For price adjustments on mat densities less than 90%, the percent of Contract Bid Price will be decreased by 10% per percentage of mat density less than 90%, unless a special evaluation performed by the Division determines a more appropriate action.

**TABLE 496.13.3B**

<b>Adjustment of Contract Price For Pavement Joint Density Not Within Tolerance</b>	
<b>Percent of Joint Density</b>	<b>Percent Adjustment</b>
Greater than 97 %	Note 3
96 % to 97 %	+2.0%
94% to 95%	+1.0
92% to 93% <sup>Note 4</sup>	0%
91 % <sup>Note 6</sup>	-1.0%
90 % <sup>Notes 5 &amp; 6</sup>	-10.0%

**Note 3:** Density greater than 97% is normally only a problem if it leads to asphalt flushing on the surface of the mat or rutting due to an unstable mix. The Division will make a special evaluation of the material and determine the appropriate action.

**Note 4:** If the longitudinal joint density is determined to be less than 94% on at least 20% of the total project Lots, then the Contractor shall be required to seal the joint a minimum of 3” on each side of the joint with a heated PG 64S-22 binder (or approved equivalent) on the entire project at no additional cost to the Division

**Note 5:** Density values less than the minimum specified 92% will be more susceptible to accelerated deterioration of both the joint and the surrounding pavement. Less than 90% will require the Division to make a special evaluation of the material and determine the appropriate action.

**Note 6:** Note 6: Any joint densities determined to be below 92% the Contractor shall be required to seal the joint a minimum of 3” on each side of the joint on the entire project with a heated PG 64S-22 binder (or approved equivalent) at no additional cost to the Division

The conditioning, cleaning, and sweeping of the existing base or underlying surface shall be considered as part of the construction of the appropriate items listed in 496.14, and no additional compensation will be allowed for "Cleaning and Sweeping".

There will be no additional compensation for tack coat material used for minor (spot) areas to be patched and leveled; the cost of this tack coat material will be included in the unit bid price for Item 401003.

There will be no additional compensation for Interim Pavement Markings.

**496.14-PAY ITEMS:**

<b>ITEM</b>	<b>DESCRIPTION</b>	<b>UNIT</b>
496001-001	Asphalt High Performance Thin Overlay, "aggregate type"	Ton (MG)
496001-003	Asphalt High Performance Thin Overlay,	Square Yard (Meter)
496002-001	Performance Graded Binder for Tack Coat, Type 64S-22	Gallon (Liter)

"aggregate type" shall be either stone and gravel or slag.



# CONTRACTOR LICENSE

AUTHORIZED BY THE  
West Virginia Contractor  
Licensing Board

NUMBER: WV001884

CLASSIFICATION:  
GENERAL ENGINEERING  
SPECIALTY

KELLY PAVING INC  
DBA KELLY PAVING INC  
PO BOX 366  
WILLIAMSTOWN, WV 26187-0366

DATE ISSUED  
AUGUST 21, 2023

EXPIRATION DATE  
AUGUST 21, 2024

*Page Thomas*  
Authorized Signature

*John Brown*  
Chair, West Virginia Contractor  
Licensing Board



A copy of this license must be readily available for inspection by the Board on every job site where contracting work is being performed. This license number must appear in all advertisements, on all bid submissions, and on all fully executed and binding contracts. This license is non-transferable. This license is being issued under the provisions of West Virginia Code, Chapter 30, Article 42.



# CERTIFICATE OF LIABILITY INSURANCE

DATE (MM/DD/YYYY)  
10/30/2023

THIS CERTIFICATE IS ISSUED AS A MATTER OF INFORMATION ONLY AND CONFERS NO RIGHTS UPON THE CERTIFICATE HOLDER. THIS CERTIFICATE DOES NOT AFFIRMATIVELY OR NEGATIVELY AMEND, EXTEND OR ALTER THE COVERAGE AFFORDED BY THE POLICIES BELOW. THIS CERTIFICATE OF INSURANCE DOES NOT CONSTITUTE A CONTRACT BETWEEN THE ISSUING INSURER(S), AUTHORIZED REPRESENTATIVE OR PRODUCER, AND THE CERTIFICATE HOLDER.

**IMPORTANT:** If the certificate holder is an ADDITIONAL INSURED, the policy(ies) must have ADDITIONAL INSURED provisions or be endorsed. If SUBROGATION IS WAIVED, subject to the terms and conditions of the policy, certain policies may require an endorsement. A statement on this certificate does not confer rights to the certificate holder in lieu of such endorsement(s).

<b>PRODUCER</b> AssuredPartners of Ohio LLC, Richfield 3900 Kinross Lakes Parkway #300 Richfield OH 44286	<b>CONTACT NAME:</b> Lisa Trnjan
	<b>PHONE (A/C, No, Ext):</b> 800-860-0090 <b>FAX (A/C, No):</b> 440-356-2126 <b>E-MAIL ADDRESS:</b> Lisa.Trnjan@assuredpartners.com
<b>INSURED</b> Kelly Paving, Inc. P.O. Box 66 Rayland OH 43943	<b>INSURER(S) AFFORDING COVERAGE</b> <b>NAIC #</b>
License#: 954553      SHEL&SA-23	<b>INSURER A:</b> Cincinnati Insurance Company      10677 <b>INSURER B:</b> American Guarantee & Liab Ins      26247 <b>INSURER C:</b> Travelers Property Casualty Co America      25674 <b>INSURER D:</b> PinnaclePoint Insurance Company      15137 <b>INSURER E:</b> <b>INSURER F:</b>

**COVERAGES**      **CERTIFICATE NUMBER:** 1353866024      **REVISION NUMBER:**

THIS IS TO CERTIFY THAT THE POLICIES OF INSURANCE LISTED BELOW HAVE BEEN ISSUED TO THE INSURED NAMED ABOVE FOR THE POLICY PERIOD INDICATED. NOTWITHSTANDING ANY REQUIREMENT, TERM OR CONDITION OF ANY CONTRACT OR OTHER DOCUMENT WITH RESPECT TO WHICH THIS CERTIFICATE MAY BE ISSUED OR MAY PERTAIN, THE INSURANCE AFFORDED BY THE POLICIES DESCRIBED HEREIN IS SUBJECT TO ALL THE TERMS, EXCLUSIONS AND CONDITIONS OF SUCH POLICIES. LIMITS SHOWN MAY HAVE BEEN REDUCED BY PAID CLAIMS.

INSR LTR	TYPE OF INSURANCE	ADDL INSD	SUBR WVD	POLICY NUMBER	POLICY EFF (MM/DD/YYYY)	POLICY EXP (MM/DD/YYYY)	LIMITS
A	<input checked="" type="checkbox"/> COMMERCIAL GENERAL LIABILITY <input type="checkbox"/> CLAIMS-MADE <input checked="" type="checkbox"/> OCCUR <input checked="" type="checkbox"/> XCU Not Excluded GEN'L AGGREGATE LIMIT APPLIES PER: <input type="checkbox"/> POLICY <input checked="" type="checkbox"/> PRO-JECT <input checked="" type="checkbox"/> LOC OTHER:	Y		ENP0609842	4/1/2023	4/1/2024	EACH OCCURRENCE \$ 1,000,000 DAMAGE TO RENTED PREMISES (Ea occurrence) \$ 500,000 MED EXP (Any one person) \$ 10,000 PERSONAL & ADV INJURY \$ 1,000,000 GENERAL AGGREGATE \$ 2,000,000 PRODUCTS - COMP/OP AGG \$ 2,000,000 \$
A	<input checked="" type="checkbox"/> AUTOMOBILE LIABILITY <input checked="" type="checkbox"/> ANY AUTO <input type="checkbox"/> OWNED AUTOS ONLY <input type="checkbox"/> SCHEDULED AUTOS <input checked="" type="checkbox"/> HIRED AUTOS ONLY <input checked="" type="checkbox"/> NON-OWNED AUTOS ONLY <input checked="" type="checkbox"/> HCPD	Y		ENP0609842	4/1/2023	4/1/2024	COMBINED SINGLE LIMIT (Ea accident) \$ 1,000,000 BODILY INJURY (Per person) \$ BODILY INJURY (Per accident) \$ PROPERTY DAMAGE (Per accident) \$ \$
A	<input checked="" type="checkbox"/> UMBRELLA LIAB <input checked="" type="checkbox"/> OCCUR <input type="checkbox"/> EXCESS LIAB <input type="checkbox"/> CLAIMS-MADE DED    RETENTIONS			EUP0573222	4/1/2023	4/1/2024	EACH OCCURRENCE \$ 5,000,000 AGGREGATE \$ 5,000,000 \$
A	<input checked="" type="checkbox"/> WORKERS COMPENSATION AND EMPLOYERS' LIABILITY ANY PROPRIETOR/PARTNER/EXECUTIVE OFFICER/MEMBER EXCLUDED? (Mandatory in NH) If yes, describe under DESCRIPTION OF OPERATIONS below	Y/N	N/A	ENP0609842	4/1/2023	4/1/2024	<input type="checkbox"/> PER STATUTE <input checked="" type="checkbox"/> OTH-ER    OH Employer Liab E.L. EACH ACCIDENT \$ 1,000,000 E.L. DISEASE - EA EMPLOYEE \$ 1,000,000 E.L. DISEASE - POLICY LIMIT \$ 1,000,000
D	Work Comp WV			WCP7006837	4/1/2023	4/1/2024	West Virginia WC
B	Excess Liab - Zurich			AEC011342108	4/1/2023	4/1/2024	XS Liab 10x5
C	Leased/Rented Equip			QT6604827A339TIL	4/1/2023	4/1/2024	Leased/Rented Equip

DESCRIPTION OF OPERATIONS / LOCATIONS / VEHICLES (ACORD 101, Additional Remarks Schedule, may be attached if more space is required)  
ARFQ 0803 DOT2400000028 ASPHALT MATERIALS, DELIVERY & LABOR BY VENDOR BY COUNTY

WV DOT is named as Additional Insured in regards to the General Liability and Automobile Liability when required by contract.

<b>CERTIFICATE HOLDER</b>  State of West Virginia Budget & Procurement Division of Highways Bldg 5, Room A-317 1900 Kanawha Blvd. E Charleston WV 25305	<b>CANCELLATION</b>  SHOULD ANY OF THE ABOVE DESCRIBED POLICIES BE CANCELLED BEFORE THE EXPIRATION DATE THEREOF, NOTICE WILL BE DELIVERED IN ACCORDANCE WITH THE POLICY PROVISIONS.  AUTHORIZED REPRESENTATIVE 
---	--



Asphalt Materials Delivery Labor by Vendor by County  
**ATTACHMENT A PRICING PAGE (ATT A)**

Vendor Name: Kelly Paving, Inc.

Vendor's Sourced Asphalt Plant(s): Plant #23  
4260 Freedom Way  
Weirton, WV 26062

**Vendor Instructions:** Vendor shall mark with an "X" the counties that correspond with the Asphalt Plant(s) bid prices on this page. If Vendor has varied pricing per county, Vendor shall complete a separate set of Pricing Pages (ATT A and ATT B if different) for each county pricing set. Vendor must complete TWO (2) Pricing Pages (ATT A and ATT B) as well as TWO (2) Plant Information Forms (ATT C and ATT D) with bid. **Bids submissions that do not include ATT A, ATT B, ATT C and ATT D WILL BE DISQUALIFIED.**

This is a multiple vendor award contract. All qualifying vendor meeting the contract specifications will be awarded with a contract. The low bid vendor per project will be determined at the time of need, as per Section 6.1 of the contract specifications. Estimated quantities are not available.

<input type="checkbox"/> Boone	<input type="checkbox"/> Cabell	<input type="checkbox"/> Calhoun	<input type="checkbox"/> Doddridge	<input type="checkbox"/> Berkeley	<input checked="" type="checkbox"/> Brooke	<input type="checkbox"/> Barbour	<input type="checkbox"/> Pendleton	<input type="checkbox"/> Fayette	<input type="checkbox"/> McDowell
<input type="checkbox"/> Clay	<input type="checkbox"/> Lincoln	<input type="checkbox"/> Jackson	<input type="checkbox"/> Harrison	<input type="checkbox"/> Grant	<input checked="" type="checkbox"/> Hancock	<input type="checkbox"/> Braxton	<input type="checkbox"/> Pocahontas	<input type="checkbox"/> Greenbrier	<input type="checkbox"/> Mercer
<input type="checkbox"/> Kanawha	<input type="checkbox"/> Logan	<input type="checkbox"/> Pleasants	<input type="checkbox"/> Marion	<input type="checkbox"/> Hampshire	<input checked="" type="checkbox"/> Marshall	<input type="checkbox"/> Gilmer	<input type="checkbox"/> Randolph	<input type="checkbox"/> Monroe	<input type="checkbox"/> Raleigh
<input type="checkbox"/> Mason	<input type="checkbox"/> Mingo	<input type="checkbox"/> Ritchie	<input type="checkbox"/> Monongalia	<input type="checkbox"/> Hardy	<input checked="" type="checkbox"/> Ohio	<input type="checkbox"/> Lewis	<input type="checkbox"/> Tucker	<input type="checkbox"/> Nicholas	<input type="checkbox"/> Wyoming
<input type="checkbox"/> Putnam	<input type="checkbox"/> Wayne	<input type="checkbox"/> Roane	<input type="checkbox"/> Preston	<input type="checkbox"/> Jefferson	<input checked="" type="checkbox"/> Tyler	<input type="checkbox"/> Upshur		<input type="checkbox"/> Summers	
		<input type="checkbox"/> Wirt	<input type="checkbox"/> Taylor	<input type="checkbox"/> Mineral	<input checked="" type="checkbox"/> Wetzel	<input type="checkbox"/> Webster			
		<input type="checkbox"/> Wood		<input type="checkbox"/> Morgan					

Contract Item #	Contract Item Description	Unit of Measure	List Price
1	Asphalt Section 401 - Base I	TON	\$77.00
2	Asphalt Section 401 - 25mm Superpave	TON	\$78.00
3	Asphalt Section 401 - Base II	TON	\$77.00
4	Asphalt Section 401 - Patch and Level	TON	\$78.00
5	Asphalt Section 401 - Wearing IV	TON	\$77.00
6	Asphalt Section 402 - Wearing IV	TON	\$86.00
7	Asphalt Section 401 - 19mm Superpave	TON	\$80.00
8	Asphalt Section 401 - Scratch Course	TON	\$84.00
9	Asphalt Section 402 - 9.5mm Superpave	TON	\$89.00
10	Asphalt Section 401 - Wearing 1	TON	\$84.00
11	Asphalt Section 402 - Wearing 1	TON	\$89.00
12	Asphalt Section 401 - 4.75mm Superpave	TON	No bid
13	Asphalt Section 402 - 4.75mm Superpave	TON	No bid
14	Asphalt Section 401 - Wearing III	TON	\$102.00
15	Asphalt Section 402 - Wearing III	TON	No bid
16	Asphalt Section 401 - 12.5mm Superpave	TON	\$81.00
17	Asphalt Section 402 - 12.5mm Superpave	TON	\$88.00
18	Shoulder Stone Placement for Asphalt Section 307 - Class 10	TON	\$60.00
19	<b>Shoulder Stone Mobilization - Complete on Attachment B (ATT B)</b>	LUMP SUM	-----
20	Haul by Vendor Shoulder Stone Placement - First Ton Mile	TON MILE	\$2.50
21	Haul by Vendor Shoulder Stone Placement - Each Additional Ton Mile	TON MILE	\$0.65
22	Surcharge for PG Binder - 64H minus 22	TON	\$10.00
23	Surcharge for PG Binder 64E minus 22 ordered in 400 Ton increments	TON	\$12.00
24	ESAL Surcharge - 3 million to 20 million ESALs	TON	\$0.25
25	ESAL Surcharge - Greater than 20 million ESALs	TON	\$0.50
26	Asphalt Haul by Vendor - First Ton Mile	TON MILE	\$2.50
27	Asphalt Haul by Vendor - Each Additional Ton Mile	TON MILE	\$0.65
28	Laydown of Materials. Items #1-17, Each Site 0-100 Tons	TON	\$130.00
29	Laydown of Materials. Items #1-17, Each Site 101 to 200 Tons	TON	\$55.00
30	Laydown of Materials. Items #1-17, Each Site 201 to 500 Tons	TON	\$22.00
31	Laydown of Materials. Items #1-17, Each Site 501 Tons or Greater	TON	\$9.50
32	<b>Mobilization - Daytime Paving - Complete on Attachment B (ATT B)</b>	LUMP SUM	-----
33	<b>Mobilization - Nighttime Paving - Complete on Attachment B (ATT B)</b>	LUMP SUM	-----
34	Excavation for Shoulder Paving - 0 to 1000 Sq. Yards	SY	\$11.00
35	Excavation for Shoulder Paving - 1001 to 2000 Sq. Yards	SY	\$9.00

Asphalt Materials Delivery Labor by Vendor by County  
**ATTACHMENT A PRICING PAGE (ATT A)**

Vendor Name: Kelly Paving, Inc.

Vendor's Sourced Asphalt Plant(s): Plant #23  
4260 Freedom Way  
Weirton, WV 26062

**Vendor Instructions:** Vendor shall mark with an "X" the counties that correspond with the Asphalt Plant(s) bid prices on this page. If Vendor has varied pricing per county, Vendor shall complete a separate set of Pricing Pages (ATT A and ATT B if different) for each county pricing set. Vendor must complete TWO (2) Pricing Pages (ATT A and ATT B) as well as TWO (2) Plant Information Forms (ATT C and ATT D) with bid. **Bids submissions that do not include ATT A, ATT B, ATT C and ATT D WILL BE DISQUALIFIED.**

This is a multiple vendor award contract. All qualifying vendor meeting the contract specifications will be awarded with a contract. The low bid vendor per project will be determined at the time of need, as per Section 6.1 of the contract specifications. Estimated quantities are not available.

- |                                  |                                  |                                    |                                     |                                    |  |                                  |                                     |                                     |                                   |
|----------------------------------|----------------------------------|------------------------------------|-------------------------------------|------------------------------------|--|----------------------------------|-------------------------------------|-------------------------------------|-----------------------------------|
| <i>District 1</i>                | <i>District 2</i>                | <i>District 3</i>                  | <i>District 4</i>                   | <i>District 5</i>                  | <i>District 6</i>                            | <i>District 7</i>                | <i>District 8</i>                   | <i>District 9</i>                   | <i>District 10</i>                |
| <input type="checkbox"/> Boone   | <input type="checkbox"/> Cabell  | <input type="checkbox"/> Calhoun   | <input type="checkbox"/> Doddridge  | <input type="checkbox"/> Berkeley  | <input checked="" type="checkbox"/> Brooke   | <input type="checkbox"/> Barbour | <input type="checkbox"/> Pendleton  | <input type="checkbox"/> Fayette    | <input type="checkbox"/> McDowell |
| <input type="checkbox"/> Clay    | <input type="checkbox"/> Lincoln | <input type="checkbox"/> Jackson   | <input type="checkbox"/> Harrison   | <input type="checkbox"/> Grant     | <input checked="" type="checkbox"/> Hancock  | <input type="checkbox"/> Braxton | <input type="checkbox"/> Pocahontas | <input type="checkbox"/> Greenbrier | <input type="checkbox"/> Mercer   |
| <input type="checkbox"/> Kanawha | <input type="checkbox"/> Logan   | <input type="checkbox"/> Pleasants | <input type="checkbox"/> Marion     | <input type="checkbox"/> Hampshire | <input checked="" type="checkbox"/> Marshall | <input type="checkbox"/> Gilmer  | <input type="checkbox"/> Randolph   | <input type="checkbox"/> Monroe     | <input type="checkbox"/> Raleigh  |
| <input type="checkbox"/> Mason   | <input type="checkbox"/> Mingo   | <input type="checkbox"/> Ritchie   | <input type="checkbox"/> Monongalia | <input type="checkbox"/> Hardy     | <input checked="" type="checkbox"/> Ohio     | <input type="checkbox"/> Lewis   | <input type="checkbox"/> Tucker     | <input type="checkbox"/> Nicholas   | <input type="checkbox"/> Wyoming  |
| <input type="checkbox"/> Putnam  | <input type="checkbox"/> Wayne   | <input type="checkbox"/> Roane     | <input type="checkbox"/> Preston    | <input type="checkbox"/> Jefferson | <input checked="" type="checkbox"/> Tyler    | <input type="checkbox"/> Upshur  |                                     | <input type="checkbox"/> Summers    |                                   |
|                                  |                                  | <input type="checkbox"/> Wirt      | <input type="checkbox"/> Taylor     | <input type="checkbox"/> Mineral   | <input checked="" type="checkbox"/> Wetzel   | <input type="checkbox"/> Webster |                                     |                                     |                                   |
|                                  |                                  | <input type="checkbox"/> Wood      |                                     | <input type="checkbox"/> Morgan    |  |                                  |                                     |                                     |                                   |

Contract Item #	Contract Item Description	Unit of Measure	List Price
36	Excavation for Shoulder Paving - 2001 to 3000 Sq. Yards	SY	\$8.00
37	Excavation for Shoulder Paving - 3001 Sq. Yards or Greater	SY	\$6.00



Asphalt Materials Delivery Labor by Vendor by County  
**ATTACHMENT A PRICING PAGE (ATT A)**

**Vendor Name:** Kelly Paving, Inc.

**Vendor's Sourced Asphalt Plant(s):** Plant #23  
4260 Freedom Way  
Weirton, WV 26062

**Vendor Instructions:** Vendor shall mark with an "X" the counties that correspond with the Asphalt Plant(s) bid prices on this page. If Vendor has varied pricing per county, Vendor shall complete a separate set of Pricing Pages (ATT A and ATT B if different) for each county pricing set. Vendor must complete TWO (2) Pricing Pages (ATT A and ATT B) as well as TWO (2) Plant Information Forms (ATT C and ATT D) with bid. **Bids submissions that do not include ATT A, ATT B, ATT C and ATT D WILL BE DISQUALIFIED.**

This is a multiple vendor award contract. All qualifying vendor meeting the contract specifications will be awarded with a contract. The low bid vendor per project will be determined at the time of need, as per Section 6.1 of the contract specifications. Estimated quantities are not available.

<input type="checkbox"/> Boone	<input type="checkbox"/> Cabell	<input type="checkbox"/> Calhoun	<input type="checkbox"/> Doddridge	<input type="checkbox"/> Berkeley	<input checked="" type="checkbox"/> Brooke	<input type="checkbox"/> Barbour	<input type="checkbox"/> Pendleton	<input type="checkbox"/> Fayette	<input type="checkbox"/> McDowell
<input type="checkbox"/> Clay	<input type="checkbox"/> Lincoln	<input type="checkbox"/> Jackson	<input type="checkbox"/> Harrison	<input type="checkbox"/> Grant	<input checked="" type="checkbox"/> Hancock	<input type="checkbox"/> Braxton	<input type="checkbox"/> Pocahontas	<input type="checkbox"/> Greenbrier	<input type="checkbox"/> Mercer
<input type="checkbox"/> Kanawha	<input type="checkbox"/> Logan	<input type="checkbox"/> Pleasants	<input type="checkbox"/> Marion	<input type="checkbox"/> Hampshire	<input checked="" type="checkbox"/> Marshall	<input type="checkbox"/> Gilmer	<input type="checkbox"/> Randolph	<input type="checkbox"/> Monroe	<input type="checkbox"/> Raleigh
<input type="checkbox"/> Mason	<input type="checkbox"/> Mingo	<input type="checkbox"/> Ritchie	<input type="checkbox"/> Monongalia	<input type="checkbox"/> Hardy	<input checked="" type="checkbox"/> Ohio	<input type="checkbox"/> Lewis	<input type="checkbox"/> Tucker	<input type="checkbox"/> Nicholas	<input type="checkbox"/> Wyoming
<input type="checkbox"/> Putnam	<input type="checkbox"/> Wayne	<input type="checkbox"/> Roane	<input type="checkbox"/> Preston	<input type="checkbox"/> Jefferson	<input checked="" type="checkbox"/> Tyler	<input type="checkbox"/> Upshur		<input type="checkbox"/> Summers	
		<input type="checkbox"/> Wirt	<input type="checkbox"/> Taylor	<input type="checkbox"/> Mineral	<input checked="" type="checkbox"/> Wetzel	<input type="checkbox"/> Webster			
		<input type="checkbox"/> Wood		<input type="checkbox"/> Morgan					

Contract Item #	Contract Item Description	Unit of Measure	List Price
38	Asphalt Base I Shoulder Paving Surcharge - 0 to 100 Tons	TON	\$16.00
39	Asphalt Base I Shoulder Paving Surcharge - 101 to 200 Tons	TON	\$11.00
40	Asphalt Base I Shoulder Paving Surcharge - 201 to 500 Tons	TON	\$9.00
41	Asphalt Base I Shoulder Paving Surcharge - 501 Tons or Greater	TON	\$7.00
42	Asphalt Base II Shoulder Paving Surcharge - 0 to 100 Tons	TON	\$15.00
43	Asphalt Base II Shoulder Paving Surcharge - 101 to 200 Tons	TON	\$13.00
44	Asphalt Base II Shoulder Paving Surcharge - 201 to 500 Tons	TON	\$8.00
45	Asphalt Base II Shoulder Paving Surcharge - 501 Tons or Greater	TON	\$7.00
46	Asphalt Material for Tack Coat	GAL	\$3.50
47	Additional Heel-In Joints	LF	\$13.00
48	Skip Paving Surcharge	TON	\$6.00
49	Pavement Profiling/Milling-WVDOH Owns Millings 0 to 250 Sq. Yards	SY	\$28.00
50	Pavement Profiling/Milling-WVDOH Owns Millings 251 to 500 Sq. Yards	SY	\$20.00
51	Pavement Profiling/Milling-WVDOH Owns Millings 501 to 1000 Sq. Yards	SY	\$12.00
52	Pavement Profiling/Milling-WVDOH Owns Millings 1001 to 2500 Sq. Yards	SY	\$9.50
53	Pavement Profiling/Milling-WVDOH Owns Millings 2501 to 5000 Sq. Yards	SY	\$4.25
54	Pavement Profiling/Milling-WVDOH Owns Millings 5001 Sq. Yards or Greater	SY	\$3.25
55	Pavement Profiling/Milling-Vendor Owns Millings 0 to 250 Sq. Yards	SY	\$28.00
56	Pavement Profiling/Milling-Vendor Owns Millings 251 to 500 Sq. Yards	SY	\$20.00
57	Pavement Profiling/Milling-Vendor Owns Millings 501 to 1000 Sq. Yards	SY	\$12.00
58	Pavement Profiling/Milling-Vendor Owns Millings 1001 to 2500 Sq. Yards	SY	\$8.00
59	Pavement Profiling/Milling-Vendor Owns Millings 2501 to 5000 Sq. Yards	SY	\$4.00
60	Pavement Profiling/Milling-Vendor Owns Millings 5001 Sq. Yards or Greater	SY	\$2.50
61	<b>Mobilization- Pavement Profiling/Milling - Complete on Attachment B (ATT B)</b>	LUMP SUM	-----
62	Haul of Profiled/Milled Cuttings or Fine Millings, First 10 Miles (Included #49-60 and #69-80)	MILE	-----
63	Haul of Profiled/Milled Cuttings or Fine Millings, Each Additional Ton Mile After 10 Miles	TON MILE	\$0.65
64	Pavement Repair - Asphalt Base II	SY	\$350.00
65	Asphalt HPTO - SP496 - PG 64E-22 ordered 400 Ton increments	TON	No bid
66	Non-Tracking Tack	GAL	No bid
67	Lay Down of Materials - to be used with #65 - 400 Ton or Greater	TON	No bid
68	Ultra-Thin Asphalt Overlay - SP498	TON	No bid



Asphalt Materials Delivery Labor by Vendor by County  
**ATTACHMENT A PRICING PAGE (ATT A)**

Vendor Name: Kelly Paving, Inc.

Vendor's Sourced Asphalt Plant(s): Plant #23  
4260 Freedom Way  
Weirton, WV 26062

**Vendor Instructions:** Vendor shall mark with an "X" the counties that correspond with the Asphalt Plant(s) bid prices on this page. If Vendor has varied pricing per county, Vendor shall complete a separate set of Pricing Pages (ATT A and ATT B if different) for each county pricing set. Vendor must complete TWO (2) Pricing Pages (ATT A and ATT B) as well as TWO (2) Plant Information Forms (ATT C and ATT D) with bid. **Bids submissions that do not include ATT A, ATT B, ATT C and ATT D WILL BE DISQUALIFIED.**

This is a multiple vendor award contract. All qualifying vendor meeting the contract specifications will be awarded with a contract. The low bid vendor per project will be determined at the time of need, as per Section 6.1 of the contract specifications. Estimated quantities are not available.

<input type="checkbox"/> Boone	<input type="checkbox"/> Cabell	<input type="checkbox"/> Calhoun	<input type="checkbox"/> Doddridge	<input type="checkbox"/> Berkeley	<input checked="" type="checkbox"/> Brooke	<input type="checkbox"/> Barbour	<input type="checkbox"/> Pendleton	<input type="checkbox"/> Fayette	<input type="checkbox"/> McDowell
<input type="checkbox"/> Clay	<input type="checkbox"/> Lincoln	<input type="checkbox"/> Jackson	<input type="checkbox"/> Harrison	<input type="checkbox"/> Grant	<input checked="" type="checkbox"/> Hancock	<input type="checkbox"/> Braxton	<input type="checkbox"/> Pocahontas	<input type="checkbox"/> Greenbrier	<input type="checkbox"/> Mercer
<input type="checkbox"/> Kanawha	<input type="checkbox"/> Logan	<input type="checkbox"/> Pleasants	<input type="checkbox"/> Marion	<input type="checkbox"/> Hampshire	<input checked="" type="checkbox"/> Marshall	<input type="checkbox"/> Gilmer	<input type="checkbox"/> Randolph	<input type="checkbox"/> Monroe	<input type="checkbox"/> Raleigh
<input type="checkbox"/> Mason	<input type="checkbox"/> Mingo	<input type="checkbox"/> Ritchie	<input type="checkbox"/> Monongalia	<input type="checkbox"/> Hardy	<input checked="" type="checkbox"/> Ohio	<input type="checkbox"/> Lewis	<input type="checkbox"/> Tucker	<input type="checkbox"/> Nicholas	<input type="checkbox"/> Wyoming
<input type="checkbox"/> Putnam	<input type="checkbox"/> Wayne	<input type="checkbox"/> Roane	<input type="checkbox"/> Preston	<input type="checkbox"/> Jefferson	<input checked="" type="checkbox"/> Tyler	<input type="checkbox"/> Upshur		<input type="checkbox"/> Summers	
		<input type="checkbox"/> Wirt	<input type="checkbox"/> Taylor	<input type="checkbox"/> Mineral	<input checked="" type="checkbox"/> Wetzel	<input type="checkbox"/> Webster			
		<input type="checkbox"/> Wood		<input type="checkbox"/> Morgan					

Contract Item #	Contract Item Description	Unit of Measure	List Price
69	Fine Milling -WVDOH Owns Millings 0 to 250 Sq. Yards	SY	\$30.00
70	Fine Milling -WVDOH Owns Millings 251 to 500 Sq. Yards	SY	\$26.00
71	Fine Milling -WVDOH Owns Millings 501 to 1000 Sq. Yards	SY	\$15.00
72	Fine Milling -WVDOH Owns Millings 1001 to 2500 Sq. Yards	SY	\$11.00
73	Fine Milling -WVDOH Owns Millings 2501 to 5000 Sq. Yards	SY	\$5.75
74	Fine Milling -WVDOH Owns Millings 5001 SY or Greater	SY	\$3.75
75	Fine Milling- Vendor Owns Millings 0 to 250 Sq. Yards	SY	\$30.00
76	Fine Milling- Vendor Owns Millings 251 to 500 Sq. Yards	SY	\$26.00
77	Fine Milling- Vendor Owns Millings 501 to 1000 Sq. Yards	SY	\$15.00
78	Fine Milling- Vendor Owns Millings 1001 to 2500 Sq. Yards	SY	\$11.00
79	Fine Milling- Vendor Owns Millings 2501 to 5000 Sq. Yards	SY	\$5.75
80	Fine Milling- Vendor Owns Millings 5001 SY or Greater	SY	\$3.75
81	Milled Rumble Strips	LF	\$1.25
82	<b>Mobilization - Milled Rumble Strips - Complete on Attachment B (ATT B)</b>	LUMP SUM	-----
83	Surcharge for Parking Lot and Facility Paving - Items #1-17, #65, and #68	TON	\$6.00
84	Cleaning and Sweeping	SY	\$0.12
85	Maintaining Traffic - Pilot Truck and Driver	DAY	\$785.00
86	Maintaining Traffic - Traffic Control Devices	UNIT	\$1.50
87	Maintaining Traffic - Flagger	HOUR	\$68.00
88	Maintaining Traffic - Arrow Board	DAY	\$30.00
89	Off-Season Plant Opening - First Day	DAY	\$6,000.00
90	Off-Season Plant Opening - Each Additional Day	DAY	\$1,200.00
91	Raised Pavement Marker (RPM), Type P-2 with Installation	EACH	\$39.00
92	Raised Pavement Marker (RPM), Type R-4 with Installation	EACH	\$25.00
93	<b>Mobilization - RPM Installation - Complete on Attachment B (ATT B)</b>	LUMP SUM	
94	Raised Pavement Marker (RPM) Removal	EACH	\$8.00
95	<b>Mobilization - RPM Removal - Complete on Attachment B (ATT B)</b>	LUMP SUM	
96	VRAM (Void Reducing Asphalt Membrane) 0-1000 LF	LINEAR FOOT	\$9.50
97	VRAM (Void Reducing Asphalt Membrane) 1001-2000 LF	LINEAR FOOT	\$8.50
98	VRAM (Void Reducing Asphalt Membrane) 2001-5,000 LF	LINEAR FOOT	\$7.50
99	VRAM (Void Reducing Asphalt Membrane) 5,001 LF or greater	LINEAR FOOT	\$5.50
100	VRAM Preparation, Removal of Center Line	LINEAR FOOT	\$5.50
101	<b>Mobilization - VRAM - Complete on Attachment B (ATT B)</b>	LUMP SUM	



Asphalt Materials Delivery Labor by Vendor by County  
**ATTACHMENT B MOBILIZATION PRICING PAGE (ATT B)**

**Vendor Name:** Kelly Paving, Inc. Plant #23, 4260 Freedom Way, Weirton, WV 26062

**Vendor Instructions:** Vendor shall complete the Mobilization Pricing Pages by entering a bid price for the Contract Items below, to correspond with the Contract items on Pricing Pages - Attachment A (ATT A). Vendor must complete TWO (2) Pricing Pages (ATT A and ATT B) as well as TWO (2) Plant Information Forms (ATT C and ATT D) with bid. **Bids submissions that do not include ATT A, ATT B, ATT C and ATT D WILL BE DISQUALIFIED.**

	County	Unit of Measure	<u>Item 19,</u> Mobilization Shoulder Stone	<u>Item 32,</u> Mobilization DAYTIME Paving	<u>Item 33,</u> Mobilization NIGHTTIME Paving	<u>Item 61,</u> Mobilization Pavement Profiling	<u>Item 82,</u> Mobilization Milled Rumble Strips	<u>Item 93</u> Mobilization RPM Installation	<u>Item 95</u> Mobilization RPM Removal	<u>Item 101</u> Mobilization VRAM
District 1	Boone	LUMP SUM								
	Clay	LUMP SUM								
	Kanawha	LUMP SUM								
	Mason	LUMP SUM								
	Putnam	LUMP SUM								
District 2	Cabell	LUMP SUM								
	Lincoln	LUMP SUM								
	Logan	LUMP SUM								
	Mingo	LUMP SUM								
	Wayne	LUMP SUM								
District 3	Calhoun	LUMP SUM								
	Jackson	LUMP SUM								
	Pleasants	LUMP SUM								
	Ritchie	LUMP SUM								
	Roane	LUMP SUM								
	Wirt	LUMP SUM								
	Wood	LUMP SUM								
District 4	Doddridge	LUMP SUM								
	Harrison	LUMP SUM								
	Marion	LUMP SUM								
	Monongalia	LUMP SUM								
	Preston	LUMP SUM								
	Taylor	LUMP SUM								

Asphalt Materials Delivery Labor by Vendor by County  
**ATTACHMENT B MOBILIZATION PRICING PAGE (ATT B)**

**Vendor Name:** Kelly Paving, Inc. Plant #23, 4260 Freedom Way, Weirton, WV 26062

**Vendor Instructions:** Vendor shall complete the Mobilization Pricing Pages by entering a bid price for the Contract Items below, to correspond with the Contract items on Pricing Pages - Attachment A (ATT A). Vendor must complete TWO (2) Pricing Pages (ATT A and ATT B) as well as TWO (2) Plant Information Forms (ATT C and ATT D) with bid. **Bids submissions that do not include ATT A, ATT B, ATT C and ATT D WILL BE DISQUALIFIED.**

	County	Unit of Measure	Item 19, Mobilization Shoulder Stone	Item 32, Mobilization DAYTIME Paving	Item 33, Mobilization NIGHTTIME Paving	Item 61, Mobilization Pavement Profiling	Item 82, Mobilization Milled Rumble Strips	Item 93 Mobilization RPM Installation	Item 95 Mobilization RPM Removal	Item 101 Mobilization VRAM
District 5	Berkeley	LUMP SUM								
	Grant	LUMP SUM								
	Hampshire	LUMP SUM								
	Hardy	LUMP SUM								
	Jefferson	LUMP SUM								
	Mineral	LUMP SUM								
	Morgan	LUMP SUM								
District 6	Brooke	LUMP SUM	\$ 1,750.00	\$ 2,000.00	\$ 2,750.00	\$ 3,500.00	\$ 3,500.00	\$ 1,300.00	\$ 1,000.00	\$ 2,750.00
	Hancock	LUMP SUM	\$ 1,750.00	\$ 2,000.00	\$ 2,750.00	\$ 3,500.00	\$ 3,500.00	\$ 1,300.00	\$ 1,000.00	\$ 2,750.00
	Marshall	LUMP SUM	\$ 1,750.00	\$ 2,000.00	\$ 2,750.00	\$ 3,500.00	\$ 3,500.00	\$ 1,300.00	\$ 1,000.00	\$ 2,750.00
	Ohio	LUMP SUM	\$ 1,750.00	\$ 2,000.00	\$ 2,750.00	\$ 3,500.00	\$ 3,500.00	\$ 1,300.00	\$ 1,000.00	\$ 2,750.00
	Tyler	LUMP SUM	\$ 1,750.00	\$ 2,000.00	\$ 2,750.00	\$ 3,500.00	\$ 3,500.00	\$ 1,300.00	\$ 1,000.00	\$ 2,750.00
	Wetzel	LUMP SUM	\$ 1,750.00	\$ 2,000.00	\$ 2,750.00	\$ 3,500.00	\$ 3,500.00	\$ 1,300.00	\$ 1,000.00	\$ 2,750.00
District 7	Barbour	LUMP SUM								
	Braxton	LUMP SUM								
	Gilmer	LUMP SUM								
	Lewis	LUMP SUM								
	Upshur	LUMP SUM								
	Webster	LUMP SUM								
District 8	Pendleton	LUMP SUM								
	Pocahontas	LUMP SUM								
	Randolph	LUMP SUM								
	Tucker	LUMP SUM								

Asphalt Materials Delivery Labor by Vendor by County  
**ATTACHMENT B MOBILIZATION PRICING PAGE (ATT B)**

**Vendor Name:** Kelly Paving, Inc. Plant #23, 4260 Freedom Way, Weirton, WV 26062

**Vendor Instructions:** Vendor shall complete the Mobilization Pricing Pages by entering a bid price for the Contract Items below, to correspond with the Contract items on Pricing Pages - Attachment A (ATT A). Vendor must complete TWO (2) Pricing Pages (ATT A and ATT B) as well as TWO (2) Plant Information Forms (ATT C and ATT D) with bid. **Bids submissions that do not include ATT A, ATT B, ATT C and ATT D WILL BE DISQUALIFIED.**

	County	Unit of Measure	<u>Item 19,</u> Mobilization Shoulder Stone	<u>Item 32,</u> Mobilization DAYTIME Paving	<u>Item 33,</u> Mobilization NIGHTTIME Paving	<u>Item 61,</u> Mobilization Pavement Profiling	<u>Item 82,</u> Mobilization Milled Rumble Strips	<u>Item 93</u> Mobilization RPM Installation	<u>Item 95</u> Mobilization RPM Removal	<u>Item 101</u> Mobilization VRAM
District 9	Fayette	LUMP SUM								
	Greenbrier	LUMP SUM								
	Monroe	LUMP SUM								
	Nicholas	LUMP SUM								
	Summers	LUMP SUM								
District 10	McDowell	LUMP SUM								
	Mercer	LUMP SUM								
	Raleigh	LUMP SUM								
	Wyoming	LUMP SUM								

## Asphalt Materials Delivery Labor by Vendor by County

### ATTACHMENT C - Asphalt Plants (ATT C)

Vendor Instructions: Vendor shall enter below the source ASPHALT Plant Names and Locations asphalt may be pulled from under this contract, and which are listed on Attachment A, including their 911 address. Vendor must list with each sourced Plant Name and Location listed the counties that plant will be used to service for this contract. Reference Section 6.3 for additional information. If additional space is needed to list additional plant locations, Vendor shall submit multiple Attachment C (ATT C) pages to ensure all plants are accounted for under this contract. Bids submissions that do not include ATT A, ATT B, ATT C and ATT D WILL BE DISQUALIFIED.

**Vendor Name: Kelly Paving, Plant #23**

Vendor's ASPHALT Plant Location for use with LAYDOWN services:									
Plant Name:	Plant #23 Weirton								
Plant Location:	4260 Freedom Way, Weirton, WV 26062								
Latitude & Longitude Coordinates:	40.38880°N, 80.60000°W								
This plant may service the following counties under this contract:									
<i>District 1</i>	<i>District 2</i>	<i>District 3</i>	<i>District 4</i>	<i>District 5</i>	<i>District 6</i>	<i>District 7</i>	<i>District 8</i>	<i>District 9</i>	<i>District 10</i>
<input type="checkbox"/> Boone	<input type="checkbox"/> Cabell	<input type="checkbox"/> Calhoun	<input type="checkbox"/> Doddridge	<input type="checkbox"/> Berkeley	<input checked="" type="checkbox"/> Brooke	<input type="checkbox"/> Barbour	<input type="checkbox"/> Pendleton	<input type="checkbox"/> Fayette	<input type="checkbox"/> McDowell
<input type="checkbox"/> Clay	<input type="checkbox"/> Lincoln	<input type="checkbox"/> Jackson	<input type="checkbox"/> Harrison	<input type="checkbox"/> Grant	<input checked="" type="checkbox"/> Hancock	<input type="checkbox"/> Braxton	<input type="checkbox"/> Pocahontas	<input type="checkbox"/> Greenbrier	<input type="checkbox"/> Mercer
<input type="checkbox"/> Kanawha	<input type="checkbox"/> Logan	<input type="checkbox"/> Pleasants	<input type="checkbox"/> Marion	<input type="checkbox"/> Hampshire	<input checked="" type="checkbox"/> Marshall	<input type="checkbox"/> Gilmer	<input type="checkbox"/> Randolph	<input type="checkbox"/> Monroe	<input type="checkbox"/> Raleigh
<input type="checkbox"/> Mason	<input type="checkbox"/> Mingo	<input type="checkbox"/> Ritchie	<input type="checkbox"/> Monongalia	<input type="checkbox"/> Hardy	<input checked="" type="checkbox"/> Ohio	<input type="checkbox"/> Lewis	<input type="checkbox"/> Tucker	<input type="checkbox"/> Nicholas	<input type="checkbox"/> Wyoming
<input type="checkbox"/> Putnam	<input type="checkbox"/> Wayne	<input type="checkbox"/> Roane	<input type="checkbox"/> Preston	<input type="checkbox"/> Jefferson	<input checked="" type="checkbox"/> Tyler	<input type="checkbox"/> Upshur		<input type="checkbox"/> Summers	
		<input type="checkbox"/> Wirt	<input type="checkbox"/> Taylor	<input type="checkbox"/> Mineral	<input checked="" type="checkbox"/> Wetzel	<input type="checkbox"/> Webster			
		<input type="checkbox"/> Wood		<input type="checkbox"/> Morgan					

Vendor's ASPHALT Plant Location for use with LAYDOWN services:									
Plant Name:									
Plant Location:									
Latitude & Longitude Coordinates:									
This plant may service the following counties under this contract:									
<i>District 1</i>	<i>District 2</i>	<i>District 3</i>	<i>District 4</i>	<i>District 5</i>	<i>District 6</i>	<i>District 7</i>	<i>District 8</i>	<i>District 9</i>	<i>District 10</i>
<input type="checkbox"/> Boone	<input type="checkbox"/> Cabell	<input type="checkbox"/> Calhoun	<input type="checkbox"/> Doddridge	<input type="checkbox"/> Berkeley	<input type="checkbox"/> Brooke	<input type="checkbox"/> Barbour	<input type="checkbox"/> Pendleton	<input type="checkbox"/> Fayette	<input type="checkbox"/> McDowell
<input type="checkbox"/> Clay	<input type="checkbox"/> Lincoln	<input type="checkbox"/> Jackson	<input type="checkbox"/> Harrison	<input type="checkbox"/> Grant	<input type="checkbox"/> Hancock	<input type="checkbox"/> Braxton	<input type="checkbox"/> Pocahontas	<input type="checkbox"/> Greenbrier	<input type="checkbox"/> Mercer
<input type="checkbox"/> Kanawha	<input type="checkbox"/> Logan	<input type="checkbox"/> Pleasants	<input type="checkbox"/> Marion	<input type="checkbox"/> Hampshire	<input type="checkbox"/> Marshall	<input type="checkbox"/> Gilmer	<input type="checkbox"/> Randolph	<input type="checkbox"/> Monroe	<input type="checkbox"/> Raleigh
<input type="checkbox"/> Mason	<input type="checkbox"/> Mingo	<input type="checkbox"/> Ritchie	<input type="checkbox"/> Monongalia	<input type="checkbox"/> Hardy	<input type="checkbox"/> Ohio	<input type="checkbox"/> Lewis	<input type="checkbox"/> Tucker	<input type="checkbox"/> Nicholas	<input type="checkbox"/> Wyoming
<input type="checkbox"/> Putnam	<input type="checkbox"/> Wayne	<input type="checkbox"/> Roane	<input type="checkbox"/> Preston	<input type="checkbox"/> Jefferson	<input type="checkbox"/> Tyler	<input type="checkbox"/> Upshur		<input type="checkbox"/> Summers	
		<input type="checkbox"/> Wirt	<input type="checkbox"/> Taylor	<input type="checkbox"/> Mineral	<input type="checkbox"/> Wetzel	<input type="checkbox"/> Webster			
		<input type="checkbox"/> Wood		<input type="checkbox"/> Morgan					

## Asphalt Materials Delivery Labor by Vendor by County

### ATTACHMENT D - Shoulder Stone Plants (ATT D)

Vendor Instructions: Vendor shall enter below the sourced STONE Plant Names and Locations stone may be pulled from under this contract, including their 911 address(es). Vendor must list with each sourced Plant Name and Location listed the counties that plant will be used to service for this contract. Reference Section 6.3 for additional information. If additional space is needed to list additional plant locations, Vendor shall submit multiple Attachment D (ATT D) pages to ensure all plants are accounted for under this contract. Bids submissions that do not include ATT A, ATT B, ATT C and ATT D WILL BE DISQUALIFIED.

**Vendor Name: Kelly Paving, Inc. Plant #23**

Vendor's SHOULDER STONE Plant Location for use with LAYDOWN services:									
Plant Name:					Plant #23 Weirton				
Plant Location:					4260 Freedom Way, Weirton, WV 26062				
Latitude & Longitude Coordinates:					40.38880°N, 80.60000°W				
This plant may service the following counties under this contract:									
<i>District 1</i>	<i>District 2</i>	<i>District 3</i>	<i>District 4</i>	<i>District 5</i>	<i>District 6</i>	<i>District 7</i>	<i>District 8</i>	<i>District 9</i>	<i>District 10</i>
<input type="checkbox"/> Boone	<input type="checkbox"/> Cabell	<input type="checkbox"/> Calhoun	<input type="checkbox"/> Doddridge	<input type="checkbox"/> Berkeley	<input checked="" type="checkbox"/> Brooke	<input type="checkbox"/> Barbour	<input type="checkbox"/> Pendleton	<input type="checkbox"/> Fayette	<input type="checkbox"/> McDowell
<input type="checkbox"/> Clay	<input type="checkbox"/> Lincoln	<input type="checkbox"/> Jackson	<input type="checkbox"/> Harrison	<input type="checkbox"/> Grant	<input checked="" type="checkbox"/> Hancock	<input type="checkbox"/> Braxton	<input type="checkbox"/> Pocahontas	<input type="checkbox"/> Greenbrier	<input type="checkbox"/> Mercer
<input type="checkbox"/> Kanawha	<input type="checkbox"/> Logan	<input type="checkbox"/> Pleasants	<input type="checkbox"/> Marion	<input type="checkbox"/> Hampshire	<input checked="" type="checkbox"/> Marshall	<input type="checkbox"/> Gilmer	<input type="checkbox"/> Randolph	<input type="checkbox"/> Monroe	<input type="checkbox"/> Raleigh
<input type="checkbox"/> Mason	<input type="checkbox"/> Mingo	<input type="checkbox"/> Ritchie	<input type="checkbox"/> Monongalia	<input type="checkbox"/> Hardy	<input checked="" type="checkbox"/> Ohio	<input type="checkbox"/> Lewis	<input type="checkbox"/> Tucker	<input type="checkbox"/> Nicholas	<input type="checkbox"/> Wyoming
<input type="checkbox"/> Putnam	<input type="checkbox"/> Wayne	<input type="checkbox"/> Roane	<input type="checkbox"/> Preston	<input type="checkbox"/> Jefferson	<input checked="" type="checkbox"/> Tyler	<input type="checkbox"/> Upshur		<input type="checkbox"/> Summers	
		<input type="checkbox"/> Wirt	<input type="checkbox"/> Taylor	<input type="checkbox"/> Mineral	<input checked="" type="checkbox"/> Wetzel	<input type="checkbox"/> Webster			
		<input type="checkbox"/> Wood		<input type="checkbox"/> Morgan					

Vendor's SHOULDER STONE Plant Location for use with LAYDOWN services:									
Plant Name:									
Plant Location:									
Latitude & Longitude Coordinates:									
This plant may service the following counties under this contract:									
<i>District 1</i>	<i>District 2</i>	<i>District 3</i>	<i>District 4</i>	<i>District 5</i>	<i>District 6</i>	<i>District 7</i>	<i>District 8</i>	<i>District 9</i>	<i>District 10</i>
<input type="checkbox"/> Boone	<input type="checkbox"/> Cabell	<input type="checkbox"/> Calhoun	<input type="checkbox"/> Doddridge	<input type="checkbox"/> Berkeley	<input type="checkbox"/> Brooke	<input type="checkbox"/> Barbour	<input type="checkbox"/> Pendleton	<input type="checkbox"/> Fayette	<input type="checkbox"/> McDowell
<input type="checkbox"/> Clay	<input type="checkbox"/> Lincoln	<input type="checkbox"/> Jackson	<input type="checkbox"/> Harrison	<input type="checkbox"/> Grant	<input type="checkbox"/> Hancock	<input type="checkbox"/> Braxton	<input type="checkbox"/> Pocahontas	<input type="checkbox"/> Greenbrier	<input type="checkbox"/> Mercer
<input type="checkbox"/> Kanawha	<input type="checkbox"/> Logan	<input type="checkbox"/> Pleasants	<input type="checkbox"/> Marion	<input type="checkbox"/> Hampshire	<input type="checkbox"/> Marshall	<input type="checkbox"/> Gilmer	<input type="checkbox"/> Randolph	<input type="checkbox"/> Monroe	<input type="checkbox"/> Raleigh
<input type="checkbox"/> Mason	<input type="checkbox"/> Mingo	<input type="checkbox"/> Ritchie	<input type="checkbox"/> Monongalia	<input type="checkbox"/> Hardy	<input type="checkbox"/> Ohio	<input type="checkbox"/> Lewis	<input type="checkbox"/> Tucker	<input type="checkbox"/> Nicholas	<input type="checkbox"/> Wyoming
<input type="checkbox"/> Putnam	<input type="checkbox"/> Wayne	<input type="checkbox"/> Roane	<input type="checkbox"/> Preston	<input type="checkbox"/> Jefferson	<input type="checkbox"/> Tyler	<input type="checkbox"/> Upshur		<input type="checkbox"/> Summers	
		<input type="checkbox"/> Wirt	<input type="checkbox"/> Taylor	<input type="checkbox"/> Mineral	<input type="checkbox"/> Wetzel	<input type="checkbox"/> Webster			
		<input type="checkbox"/> Wood		<input type="checkbox"/> Morgan					

Asphalt Materials Delivery Labor by Vendor by County  
**ATTACHMENT B MOBILIZATION PRICING PAGE (ATT B)**

**Vendor Name:** Kelly Paving, Inc. Plant #23, 4260 Freedom Way, Weirton, WV 26062

**Vendor Instructions:** Vendor shall complete the Mobilization Pricing Pages by entering a bid price for the Contract Items below, to correspond with the Contract items on Pricing Pages - Attachment A (ATT A). Vendor must complete TWO (2) Pricing Pages (ATT A and ATT B) as well as TWO (2) Plant Information Forms (ATT C and ATT D) with bid. **Bids submissions that do not include ATT A, ATT B, ATT C and ATT D WILL BE DISQUALIFIED.**

	County	Unit of Measure	<u>Item 19,</u> Mobilization Shoulder Stone	<u>Item 32,</u> Mobilization DAYTIME Paving	<u>Item 33,</u> Mobilization NIGHTTIME Paving	<u>Item 61,</u> Mobilization Pavement Profiling	<u>Item 82,</u> Mobilization Milled Rumble Strips	<u>Item 93</u> Mobilization RPM Installation	<u>Item 95</u> Mobilization RPM Removal	<u>Item 101</u> Mobilization VRAM
District 1	Boone	LUMP SUM								
	Clay	LUMP SUM								
	Kanawha	LUMP SUM								
	Mason	LUMP SUM								
	Putnam	LUMP SUM								
District 2	Cabell	LUMP SUM								
	Lincoln	LUMP SUM								
	Logan	LUMP SUM								
	Mingo	LUMP SUM								
	Wayne	LUMP SUM								
District 3	Calhoun	LUMP SUM								
	Jackson	LUMP SUM								
	Pleasants	LUMP SUM								
	Ritchie	LUMP SUM								
	Roane	LUMP SUM								
	Wirt	LUMP SUM								
	Wood	LUMP SUM								
District 4	Doddridge	LUMP SUM								
	Harrison	LUMP SUM								
	Marion	LUMP SUM								
	Monongalia	LUMP SUM								
	Preston	LUMP SUM								
	Taylor	LUMP SUM								

Asphalt Materials Delivery Labor by Vendor by County  
**ATTACHMENT B MOBILIZATION PRICING PAGE (ATT B)**

**Vendor Name:** Kelly Paving, Inc. Plant #23, 4260 Freedom Way, Weirton, WV 26062

**Vendor Instructions:** Vendor shall complete the Mobilization Pricing Pages by entering a bid price for the Contract Items below, to correspond with the Contract items on Pricing Pages - Attachment A (ATT A). Vendor must complete TWO (2) Pricing Pages (ATT A and ATT B) as well as TWO (2) Plant Information Forms (ATT C and ATT D) with bid. **Bids submissions that do not include ATT A, ATT B, ATT C and ATT D WILL BE DISQUALIFIED.**

	County	Unit of Measure	<u>Item 19,</u> Mobilization Shoulder Stone	<u>Item 32,</u> Mobilization DAYTIME Paving	<u>Item 33,</u> Mobilization NIGHTTIME Paving	<u>Item 61,</u> Mobilization Pavement Profiling	<u>Item 82,</u> Mobilization Milled Rumble Strips	<u>Item 93</u> Mobilization RPM Installation	<u>Item 95</u> Mobilization RPM Removal	<u>Item 101</u> Mobilization VRAM
District 5	Berkeley	LUMP SUM								
	Grant	LUMP SUM								
	Hampshire	LUMP SUM								
	Hardy	LUMP SUM								
	Jefferson	LUMP SUM								
	Mineral	LUMP SUM								
	Morgan	LUMP SUM								
District 6	Brooke	LUMP SUM	\$ 1,750.00	\$ 2,000.00	\$ 2,750.00	\$ 3,500.00	\$ 3,500.00	\$ 1,300.00	\$ 1,000.00	\$ 2,750.00
	Hancock	LUMP SUM	\$ 1,750.00	\$ 2,000.00	\$ 2,750.00	\$ 3,500.00	\$ 3,500.00	\$ 1,300.00	\$ 1,000.00	\$ 2,750.00
	Marshall	LUMP SUM	\$ 1,750.00	\$ 2,000.00	\$ 2,750.00	\$ 3,500.00	\$ 3,500.00	\$ 1,300.00	\$ 1,000.00	\$ 2,750.00
	Ohio	LUMP SUM	\$ 1,750.00	\$ 2,000.00	\$ 2,750.00	\$ 3,500.00	\$ 3,500.00	\$ 1,300.00	\$ 1,000.00	\$ 2,750.00
	Tyler	LUMP SUM	\$ 1,750.00	\$ 2,000.00	\$ 2,750.00	\$ 3,500.00	\$ 3,500.00	\$ 1,300.00	\$ 1,000.00	\$ 2,750.00
	Wetzel	LUMP SUM	\$ 1,750.00	\$ 2,000.00	\$ 2,750.00	\$ 3,500.00	\$ 3,500.00	\$ 1,300.00	\$ 1,000.00	\$ 2,750.00
District 7	Barbour	LUMP SUM								
	Braxton	LUMP SUM								
	Gilmer	LUMP SUM								
	Lewis	LUMP SUM								
	Upshur	LUMP SUM								
	Webster	LUMP SUM								
District 8	Pendleton	LUMP SUM								
	Pocahontas	LUMP SUM								
	Randolph	LUMP SUM								
	Tucker	LUMP SUM								

Asphalt Materials Delivery Labor by Vendor by County  
**ATTACHMENT B MOBILIZATION PRICING PAGE (ATT B)**

**Vendor Name:** Kelly Paving, Inc. Plant #23, 4260 Freedom Way, Weirton, WV 26062

**Vendor Instructions:** Vendor shall complete the Mobilization Pricing Pages by entering a bid price for the Contract Items below, to correspond with the Contract items on Pricing Pages - Attachment A (ATT A). Vendor must complete TWO (2) Pricing Pages (ATT A and ATT B) as well as TWO (2) Plant Information Forms (ATT C and ATT D) with bid. **Bids submissions that do not include ATT A, ATT B, ATT C and ATT D WILL BE DISQUALIFIED.**

	County	Unit of Measure	<u>Item 19,</u> Mobilization Shoulder Stone	<u>Item 32,</u> Mobilization DAYTIME Paving	<u>Item 33,</u> Mobilization NIGHTTIME Paving	<u>Item 61,</u> Mobilization Pavement Profiling	<u>Item 82,</u> Mobilization Milled Rumble Strips	<u>Item 93</u> Mobilization RPM Installation	<u>Item 95</u> Mobilization RPM Removal	<u>Item 101</u> Mobilization VRAM
District 9	Fayette	LUMP SUM								
	Greenbrier	LUMP SUM								
	Monroe	LUMP SUM								
	Nicholas	LUMP SUM								
	Summers	LUMP SUM								
District 10	McDowell	LUMP SUM								
	Mercer	LUMP SUM								
	Raleigh	LUMP SUM								
	Wyoming	LUMP SUM								



Asphalt Materials Delivery Labor by Vendor by County  
**ATTACHMENT A PRICING PAGE (ATT A)**

**Vendor Name:** Kelly Paving, Inc.

**Vendor's Sourced Asphalt Plant(s):** Plant #23

4260 Freedom Way

Weirton, WV 26062

**Vendor Instructions:** Vendor shall mark with an "X" the counties that correspond with the Asphalt Plant(s) bid prices on this page. If Vendor has varied pricing per county, Vendor shall complete a separate set of Pricing Pages (ATT A and ATT B if different) for each county pricing set. Vendor must complete TWO (2) Pricing Pages (ATT A and ATT B) as well as TWO (2) Plant Information Forms (ATT C and ATT D) with bid. **Bids submissions that do not include ATT A, ATT B, ATT C and ATT D WILL BE DISQUALIFIED.**

This is a multiple vendor award contract. All qualifying vendor meeting the contract specifications will be awarded with a contract. The low bid vendor per project will be determined at the time of need, as per Section 6.1 of the contract specifications. Estimated quantities are not available.

<i>District 1</i>	<i>District 2</i>	<i>District 3</i>	<i>District 4</i>	<i>District 5</i>	<i>District 6</i>	<i>District 7</i>	<i>District 8</i>	<i>District 9</i>	<i>District 10</i>
<input type="checkbox"/> Boone	<input type="checkbox"/> Cabell	<input type="checkbox"/> Calhoun	<input type="checkbox"/> Doddridge	<input type="checkbox"/> Berkeley	<input checked="" type="checkbox"/> Brooke	<input type="checkbox"/> Barbour	<input type="checkbox"/> Pendleton	<input type="checkbox"/> Fayette	<input type="checkbox"/> McDowell
<input type="checkbox"/> Clay	<input type="checkbox"/> Lincoln	<input type="checkbox"/> Jackson	<input type="checkbox"/> Harrison	<input type="checkbox"/> Grant	<input checked="" type="checkbox"/> Hancock	<input type="checkbox"/> Braxton	<input type="checkbox"/> Pocahontas	<input type="checkbox"/> Greenbrier	<input type="checkbox"/> Mercer
<input type="checkbox"/> Kanawha	<input type="checkbox"/> Logan	<input type="checkbox"/> Pleasants	<input type="checkbox"/> Marion	<input checked="" type="checkbox"/> Hampshire	<input checked="" type="checkbox"/> Marshall	<input type="checkbox"/> Gilmer	<input type="checkbox"/> Randolph	<input type="checkbox"/> Monroe	<input type="checkbox"/> Raleigh
<input type="checkbox"/> Mason	<input type="checkbox"/> Mingo	<input type="checkbox"/> Ritchie	<input type="checkbox"/> Monongalia	<input type="checkbox"/> Hardy	<input checked="" type="checkbox"/> Ohio	<input type="checkbox"/> Lewis	<input type="checkbox"/> Tucker	<input type="checkbox"/> Nicholas	<input type="checkbox"/> Wyoming
<input type="checkbox"/> Putnam	<input type="checkbox"/> Wayne	<input type="checkbox"/> Roane	<input type="checkbox"/> Preston	<input type="checkbox"/> Jefferson	<input checked="" type="checkbox"/> Tyler	<input type="checkbox"/> Upshur		<input type="checkbox"/> Summers	
		<input type="checkbox"/> Wirt	<input type="checkbox"/> Taylor	<input type="checkbox"/> Mineral	<input checked="" type="checkbox"/> Wetzell	<input type="checkbox"/> Webster			
		<input type="checkbox"/> Wood		<input type="checkbox"/> Morgan					

Contract Item #	Contract Item Description	Unit of Measure	List Price
1	Asphalt Section 401 - Base I	TON	\$77.00
2	Asphalt Section 401 - 25mm Superpave	TON	\$78.00
3	Asphalt Section 401 - Base II	TON	\$77.00
4	Asphalt Section 401 - Patch and Level	TON	\$78.00
5	Asphalt Section 401 - Wearing IV	TON	\$77.00
6	Asphalt Section 402 - Wearing IV	TON	\$86.00
7	Asphalt Section 401 - 19mm Superpave	TON	\$80.00
8	Asphalt Section 401 - Scratch Course	TON	\$84.00
9	Asphalt Section 402 - 9.5mm Superpave	TON	\$89.00
10	Asphalt Section 401 - Wearing 1	TON	\$84.00
11	Asphalt Section 402 - Wearing 1	TON	\$89.00
12	Asphalt Section 401 - 4.75mm Superpave	TON	No bid
13	Asphalt Section 402 - 4.75mm Superpave	TON	No bid
14	Asphalt Section 401 - Wearing III	TON	\$102.00
15	Asphalt Section 402 - Wearing III	TON	No bid
16	Asphalt Section 401 - 12.5mm Superpave	TON	\$81.00
17	Asphalt Section 402 - 12.5mm Superpave	TON	\$88.00
18	Shoulder Stone Placement for Asphalt Section 307 - Class 10	TON	\$60.00
19	Shoulder Stone Mobilization - <b>Complete on Attachment B (ATT B)</b>	LUMP SUM	-----
20	Haul by Vendor Shoulder Stone Placement - First Ton Mile	TON MILE	\$2.50
21	Haul by Vendor Shoulder Stone Placement - Each Additional Ton Mile	TON MILE	\$0.65
22	Surcharge for PG Binder - 64H minus 22	TON	\$10.00
23	Surcharge for PG Binder 64E minus 22 ordered in 400 Ton increments	TON	\$12.00
24	ESAL Surcharge - 3 million to 20 million ESALs	TON	\$0.25
25	ESAL Surcharge - Greater than 20 million ESALs	TON	\$0.50
26	Asphalt Haul by Vendor - First Ton Mile	TON MILE	\$2.50
27	Asphalt Haul by Vendor - Each Additional Ton Mile	TON MILE	\$0.65
28	Laydown of Materials. Items #1-17, Each Site 0-100 Tons	TON	\$130.00
29	Laydown of Materials. Items #1-17, Each Site 101 to 200 Tons	TON	\$55.00
30	Laydown of Materials. Items #1-17, Each Site 201 to 500 Tons	TON	\$22.00
31	Laydown of Materials. Items #1-17, Each Site 501 Tons or Greater	TON	\$9.50
32	Mobilization - Daytime Paving - <b>Complete on Attachment B (ATT B)</b>	LUMP SUM	-----
33	Mobilization - Nighttime Paving - <b>Complete on Attachment B (ATT B)</b>	LUMP SUM	-----
34	Excavation for Shoulder Paving - 0 to 1000 Sq. Yards	SY	\$11.00
35	Excavation for Shoulder Paving - 1001 to 2000 Sq. Yards	SY	\$9.00
36	Excavation for Shoulder Paving - 2001 to 3000 Sq. Yards	SY	\$8.00
37	Excavation for Shoulder Paving - 3001 Sq. Yards or Greater	SY	\$6.00

Asphalt Materials Delivery Labor by Vendor by County  
**ATTACHMENT A PRICING PAGE (ATT A)**

**Vendor Name:** Kelly Paving, Inc.

**Vendor's Sourced Asphalt Plant(s):** Plant #23

4260 Freedom Way  
 Weirton, WV 26062

**Vendor Instructions:** Vendor shall mark with an "X" the counties that correspond with the Asphalt Plant(s) bid prices on this page. If Vendor has varied pricing per county, Vendor shall complete a separate set of Pricing Pages (ATT A and ATT B if different) for each county pricing set. Vendor must complete TWO (2) Pricing Pages (ATT A and ATT B) as well as TWO (2) Plant Information Forms (ATT C and ATT D) with bid. **Bids submissions that do not include ATT A, ATT B, ATT C and ATT D WILL BE DISQUALIFIED.**

This is a multiple vendor award contract. All qualifying vendor meeting the contract specifications will be awarded with a contract. The low bid vendor per project will be determined at the time of need, as per Section 6.1 of the contract specifications. Estimated quantities are not available.

<i>District 1</i>	<i>District 2</i>	<i>District 3</i>	<i>District 4</i>	<i>District 5</i>	<i>District 6</i>	<i>District 7</i>	<i>District 8</i>	<i>District 9</i>	<i>District 10</i>
<input type="checkbox"/> Boone	<input type="checkbox"/> Cabell	<input type="checkbox"/> Calhoun	<input type="checkbox"/> Doddridge	<input type="checkbox"/> Berkeley	<input checked="" type="checkbox"/> Brooke	<input type="checkbox"/> Barbour	<input type="checkbox"/> Pendleton	<input type="checkbox"/> Fayette	<input type="checkbox"/> McDowell
<input type="checkbox"/> Clay	<input type="checkbox"/> Lincoln	<input type="checkbox"/> Jackson	<input type="checkbox"/> Harrison	<input type="checkbox"/> Grant	<input checked="" type="checkbox"/> Hancock	<input type="checkbox"/> Braxton	<input type="checkbox"/> Pocahontas	<input type="checkbox"/> Greenbrier	<input type="checkbox"/> Mercer
<input type="checkbox"/> Kanawha	<input type="checkbox"/> Logan	<input type="checkbox"/> Pleasants	<input type="checkbox"/> Marion	<input checked="" type="checkbox"/> Hampshire	<input checked="" type="checkbox"/> Marshall	<input type="checkbox"/> Gilmer	<input type="checkbox"/> Randolph	<input type="checkbox"/> Monroe	<input type="checkbox"/> Raleigh
<input type="checkbox"/> Mason	<input type="checkbox"/> Mingo	<input type="checkbox"/> Ritchie	<input type="checkbox"/> Monongalia	<input type="checkbox"/> Hardy	<input checked="" type="checkbox"/> Ohio	<input type="checkbox"/> Lewis	<input type="checkbox"/> Tucker	<input type="checkbox"/> Nicholas	<input type="checkbox"/> Wyoming
<input type="checkbox"/> Putnam	<input type="checkbox"/> Wayne	<input type="checkbox"/> Roane	<input type="checkbox"/> Preston	<input type="checkbox"/> Jefferson	<input checked="" type="checkbox"/> Tyler	<input type="checkbox"/> Upshur		<input type="checkbox"/> Summers	
		<input type="checkbox"/> Wirt	<input type="checkbox"/> Taylor	<input type="checkbox"/> Mineral	<input checked="" type="checkbox"/> Wetzell	<input type="checkbox"/> Webster			
		<input type="checkbox"/> Wood		<input type="checkbox"/> Morgan					

Contract Item #	Contract Item Description	Unit of Measure	List Price
38	Asphalt Base I Shoulder Paving Surcharge - 0 to 100 Tons	TON	\$16.00
39	Asphalt Base I Shoulder Paving Surcharge - 101 to 200 Tons	TON	\$11.00
40	Asphalt Base I Shoulder Paving Surcharge - 201 to 500 Tons	TON	\$9.00
41	Asphalt Base I Shoulder Paving Surcharge - 501 Tons or Greater	TON	\$7.00
42	Asphalt Base II Shoulder Paving Surcharge - 0 to 100 Tons	TON	\$15.00
43	Asphalt Base II Shoulder Paving Surcharge - 101 to 200 Tons	TON	\$13.00
44	Asphalt Base II Shoulder Paving Surcharge - 201 to 500 Tons	TON	\$8.00
45	Asphalt Base II Shoulder Paving Surcharge - 501 Tons or Greater	TON	\$7.00
46	Asphalt Material for Tack Coat	GAL	\$3.50
47	Additional Heel-In Joints	LF	\$13.00
48	Skip Paving Surcharge	TON	\$6.00
49	Pavement Profiling/Milling-WVDOH Owns Millings 0 to 250 Sq. Yards	SY	\$28.00
50	Pavement Profiling/Milling-WVDOH Owns Millings 251 to 500 Sq. Yards	SY	\$20.00
51	Pavement Profiling/Milling-WVDOH Owns Millings 501 to 1000 Sq. Yards	SY	\$12.00
52	Pavement Profiling/Milling-WVDOH Owns Millings 1001 to 2500 Sq. Yards	SY	\$9.50
53	Pavement Profiling/Milling-WVDOH Owns Millings 2501 to 5000 Sq. Yards	SY	\$4.25
54	Pavement Profiling/Milling-WVDOH Owns Millings 5001 Sq. Yards or Greater	SY	\$3.25
55	Pavement Profiling/Milling-Vendor Owns Millings 0 to 250 Sq. Yards	SY	\$28.00
56	Pavement Profiling/Milling-Vendor Owns Millings 251 to 500 Sq. Yards	SY	\$20.00
57	Pavement Profiling/Milling-Vendor Owns Millings 501 to 1000 Sq. Yards	SY	\$12.00
58	Pavement Profiling/Milling-Vendor Owns Millings 1001 to 2500 Sq. Yards	SY	\$8.00
59	Pavement Profiling/Milling-Vendor Owns Millings 2501 to 5000 Sq. Yards	SY	\$4.00
60	Pavement Profiling/Milling-Vendor Owns Millings 5001 Sq. Yards or Greater	SY	\$2.50
61	Mobilization- Pavement Profiling/Milling - <b>Complete on Attachment B (ATT B)</b>	LUMP SUM	-----
62	Haul of Profiled/Milled Cuttings or Fine Millings, First 10 Miles (Included #49-60 and #69-80)	MILE	-----
63	Haul of Profiled/Milled Cuttings or Fine Millings, Each Additional Ton Mile After 10 Miles	TON MILE	\$0.65
64	Pavement Repair - Asphalt Base II	SY	\$350.00
65	Asphalt HPTO - SP496 - PG 64E-22 ordered 400 Ton increments	TON	No bid
66	Non-Tracking Tack	GAL	No bid
67	Lay Down of Materials - to be used with #65 - 400 Ton or Greater	TON	No bid
68	Ultra-Thin Asphalt Overlay - SP498	TON	No bid

Asphalt Materials Delivery Labor by Vendor by County  
**ATTACHMENT A PRICING PAGE (ATT A)**

**Vendor Name:** Kelly Paving, Inc.

**Vendor's Sourced Asphalt Plant(s):** Plant #23

4260 Freedom Way

Weirton, WV 26062

**Vendor Instructions:** Vendor shall mark with an "X" the counties that correspond with the Asphalt Plant(s) bid prices on this page. If Vendor has varied pricing per county, Vendor shall complete a separate set of Pricing Pages (ATT A and ATT B if different) for each county pricing set. Vendor must complete TWO (2) Pricing Pages (ATT A and ATT B) as well as TWO (2) Plant Information Forms (ATT C and ATT D) with bid. **Bids submissions that do not include ATT A, ATT B, ATT C and ATT D WILL BE DISQUALIFIED.**

This is a multiple vendor award contract. All qualifying vendor meeting the contract specifications will be awarded with a contract. The low bid vendor per project will be determined at the time of need, as per Section 6.1 of the contract specifications. Estimated quantities are not available.

<i>District 1</i>	<i>District 2</i>	<i>District 3</i>	<i>District 4</i>	<i>District 5</i>	<i>District 6</i>	<i>District 7</i>	<i>District 8</i>	<i>District 9</i>	<i>District 10</i>
<input type="checkbox"/> Boone	<input type="checkbox"/> Cabell	<input type="checkbox"/> Calhoun	<input type="checkbox"/> Doddridge	<input type="checkbox"/> Berkeley	<input checked="" type="checkbox"/> Brooke	<input type="checkbox"/> Barbour	<input type="checkbox"/> Pendleton	<input type="checkbox"/> Fayette	<input type="checkbox"/> McDowell
<input type="checkbox"/> Clay	<input type="checkbox"/> Lincoln	<input type="checkbox"/> Jackson	<input type="checkbox"/> Harrison	<input type="checkbox"/> Grant	<input checked="" type="checkbox"/> Hancock	<input type="checkbox"/> Braxton	<input type="checkbox"/> Pocahontas	<input type="checkbox"/> Greenbrier	<input type="checkbox"/> Mercer
<input type="checkbox"/> Kanawha	<input type="checkbox"/> Logan	<input type="checkbox"/> Pleasants	<input type="checkbox"/> Marion	<input type="checkbox"/> Hampshire	<input checked="" type="checkbox"/> Marshall	<input type="checkbox"/> Gilmer	<input type="checkbox"/> Randolph	<input type="checkbox"/> Monroe	<input type="checkbox"/> Raleigh
<input type="checkbox"/> Mason	<input type="checkbox"/> Mingo	<input type="checkbox"/> Ritchie	<input type="checkbox"/> Monongalia	<input type="checkbox"/> Hardy	<input checked="" type="checkbox"/> Ohio	<input type="checkbox"/> Lewis	<input type="checkbox"/> Tucker	<input type="checkbox"/> Nicholas	<input type="checkbox"/> Wyoming
<input type="checkbox"/> Putnam	<input type="checkbox"/> Wayne	<input type="checkbox"/> Roane	<input type="checkbox"/> Preston	<input type="checkbox"/> Jefferson	<input checked="" type="checkbox"/> Tyler	<input type="checkbox"/> Upshur		<input type="checkbox"/> Summers	
		<input type="checkbox"/> Wirt	<input type="checkbox"/> Taylor	<input type="checkbox"/> Mineral	<input checked="" type="checkbox"/> Wetzell	<input type="checkbox"/> Webster			
		<input type="checkbox"/> Wood		<input type="checkbox"/> Morgan					

Contract Item #	Contract Item Description	Unit of Measure	List Price
69	Fine Milling -WVDOH Owns Millings 0 to 250 Sq. Yards	SY	\$30.00
70	Fine Milling -WVDOH Owns Millings 251 to 500 Sq. Yards	SY	\$26.00
71	Fine Milling -WVDOH Owns Millings 501 to 1000 Sq. Yards	SY	\$15.00
72	Fine Milling -WVDOH Owns Millings 1001 to 2500 Sq. Yards	SY	\$11.00
73	Fine Milling -WVDOH Owns Millings 2501 to 5000 Sq. Yards	SY	\$5.75
74	Fine Milling -WVDOH Owns Millings 5001 SY or Greater	SY	\$3.75
75	Fine Milling- Vendor Owns Millings 0 to 250 Sq. Yards	SY	\$30.00
76	Fine Milling- Vendor Owns Millings 251 to 500 Sq. Yards	SY	\$26.00
77	Fine Milling- Vendor Owns Millings 501 to 1000 Sq. Yards	SY	\$15.00
78	Fine Milling- Vendor Owns Millings 1001 to 2500 Sq. Yards	SY	\$11.00
79	Fine Milling- Vendor Owns Millings 2501 to 5000 Sq. Yards	SY	\$5.75
80	Fine Milling- Vendor Owns Millings 5001 SY or Greater	SY	\$3.75
81	Milled Rumble Strips	LF	\$1.25
82	Mobilization - Milled Rumble Strips - <b>Complete on Attachment B (ATT B)</b>	LUMP SUM	-----
83	Surcharge for Parking Lot and Facility Paving - Items #1-17, #65, and #68	TON	\$6.00
84	Cleaning and Sweeping	SY	\$0.12
85	Maintaining Traffic - Pilot Truck and Driver	DAY	\$785.00
86	Maintaining Traffic - Traffic Control Devices	UNIT	\$1.50
87	Maintaining Traffic - Flagger	HOUR	\$68.00
88	Maintaining Traffic - Arrow Board	DAY	\$30.00
89	Off-Season Plant Opening - First Day	DAY	\$6,000.00
90	Off-Season Plant Opening - Each Additional Day	DAY	\$1,200.00
91	Raised Pavement Marker (RPM), Type P-2 with Installation	EACH	\$39.00
92	Raised Pavement Marker (RPM), Type R-4 with Installation	EACH	\$25.00
93	Mobilization - RPM Installation - <b>Complete on Attachment B (ATT B)</b>	LUMP SUM	
94	Raised Pavement Marker (RPM) Removal	EACH	\$8.00
95	Mobilization - RPM Removal - <b>Complete on Attachment B (ATT B)</b>	LUMP SUM	
96	VRAM (Void Reducing Asphalt Membrane) 0-1000 LF	LINEAR FOOT	\$9.50
97	VRAM (Void Reducing Asphalt Membrane) 1001-2000 LF	LINEAR FOOT	\$8.50
98	VRAM (Void Reducing Asphalt Membrane) 2001-5,000 LF	LINEAR FOOT	\$7.50
99	VRAM (Void Reducing Asphalt Membrane) 5,001 LF or greater	LINEAR FOOT	\$5.50
100	VRAM Preparation, Removal of Center Line	LINEAR FOOT	\$5.50
101	Mobilization - VRAM - <b>Complete on Attachment B (ATT B)</b>	LUMP SUM	

## Asphalt Materials Delivery Labor by Vendor by County

### ATTACHMENT C - Asphalt Plants (ATT C)

Vendor Instructions: Vendor shall enter below the source ASPHALT Plant Names and Locations asphalt may be pulled from under this contract, and which are listed on Attachment A, including their 911 address. Vendor must list with each sourced Plant Name and Location listed the counties that plant will be used to service for this contract. Reference Section 6.3 for additional information. If additional space is needed to list additional plant locations, Vendor shall submit multiple Attachment C (ATT C) pages to ensure all plants are accounted for under this contract. Bids submissions that do not include ATT A, ATT B, ATT C and ATT D WILL BE DISQUALIFIED.

**Vendor Name: Kelly Paving, Plant #23**

Vendor's <b>ASPHALT</b> Plant Location for use with LAYDOWN services:									
Plant Name:					Plant #23 Weirton				
Plant Location:					4260 Freedom Way, Weirton, WV 26062				
Latitude & Longitude Coordinates:					40.38880° N, 80.60000° W				
This plant may service the following counties under this contract:									
<i>District 1</i>	<i>District 2</i>	<i>District 3</i>	<i>District 4</i>	<i>District 5</i>	<i>District 6</i>	<i>District 7</i>	<i>District 8</i>	<i>District 9</i>	<i>District 10</i>
<input type="checkbox"/> Boone	<input type="checkbox"/> Cabell	<input type="checkbox"/> Calhoun	<input type="checkbox"/> Doddridge	<input type="checkbox"/> Berkeley	<input checked="" type="checkbox"/> Brooke	<input type="checkbox"/> Barbour	<input type="checkbox"/> Pendleton	<input type="checkbox"/> Fayette	<input type="checkbox"/> McDowell
<input type="checkbox"/> Clay	<input type="checkbox"/> Lincoln	<input type="checkbox"/> Jackson	<input type="checkbox"/> Harrison	<input type="checkbox"/> Grant	<input checked="" type="checkbox"/> Hancock	<input type="checkbox"/> Braxton	<input type="checkbox"/> Pocahontas	<input type="checkbox"/> Greenbrier	<input type="checkbox"/> Mercer
<input type="checkbox"/> Kanawha	<input type="checkbox"/> Logan	<input type="checkbox"/> Pleasants	<input type="checkbox"/> Marion	<input type="checkbox"/> Hampshire	<input checked="" type="checkbox"/> Marshall	<input type="checkbox"/> Gilmer	<input type="checkbox"/> Randolph	<input type="checkbox"/> Monroe	<input type="checkbox"/> Raleigh
<input type="checkbox"/> Mason	<input type="checkbox"/> Mingo	<input type="checkbox"/> Ritchie	<input type="checkbox"/> Monongalia	<input type="checkbox"/> Hardy	<input checked="" type="checkbox"/> Ohio	<input type="checkbox"/> Lewis	<input type="checkbox"/> Tucker	<input type="checkbox"/> Nicholas	<input type="checkbox"/> Wyoming
<input type="checkbox"/> Putnam	<input type="checkbox"/> Wayne	<input type="checkbox"/> Roane	<input type="checkbox"/> Preston	<input type="checkbox"/> Jefferson	<input checked="" type="checkbox"/> Tyler	<input type="checkbox"/> Upshur		<input type="checkbox"/> Summers	
		<input type="checkbox"/> Wirt	<input type="checkbox"/> Taylor	<input type="checkbox"/> Mineral	<input checked="" type="checkbox"/> Wetzel	<input type="checkbox"/> Webster			
		<input type="checkbox"/> Wood		<input type="checkbox"/> Morgan					

Vendor's <b>ASPHALT</b> Plant Location for use with LAYDOWN services:									
Plant Name:					_____				
Plant Location:					_____				
Latitude & Longitude Coordinates:					_____				
This plant may service the following counties under this contract:									
<i>District 1</i>	<i>District 2</i>	<i>District 3</i>	<i>District 4</i>	<i>District 5</i>	<i>District 6</i>	<i>District 7</i>	<i>District 8</i>	<i>District 9</i>	<i>District 10</i>
<input type="checkbox"/> Boone	<input type="checkbox"/> Cabell	<input type="checkbox"/> Calhoun	<input type="checkbox"/> Doddridge	<input type="checkbox"/> Berkeley	<input type="checkbox"/> Brooke	<input type="checkbox"/> Barbour	<input type="checkbox"/> Pendleton	<input type="checkbox"/> Fayette	<input type="checkbox"/> McDowell
<input type="checkbox"/> Clay	<input type="checkbox"/> Lincoln	<input type="checkbox"/> Jackson	<input type="checkbox"/> Harrison	<input type="checkbox"/> Grant	<input type="checkbox"/> Hancock	<input type="checkbox"/> Braxton	<input type="checkbox"/> Pocahontas	<input type="checkbox"/> Greenbrier	<input type="checkbox"/> Mercer
<input type="checkbox"/> Kanawha	<input type="checkbox"/> Logan	<input type="checkbox"/> Pleasants	<input type="checkbox"/> Marion	<input type="checkbox"/> Hampshire	<input type="checkbox"/> Marshall	<input type="checkbox"/> Gilmer	<input type="checkbox"/> Randolph	<input type="checkbox"/> Monroe	<input type="checkbox"/> Raleigh
<input type="checkbox"/> Mason	<input type="checkbox"/> Mingo	<input type="checkbox"/> Ritchie	<input type="checkbox"/> Monongalia	<input type="checkbox"/> Hardy	<input type="checkbox"/> Ohio	<input type="checkbox"/> Lewis	<input type="checkbox"/> Tucker	<input type="checkbox"/> Nicholas	<input type="checkbox"/> Wyoming
<input type="checkbox"/> Putnam	<input type="checkbox"/> Wayne	<input type="checkbox"/> Roane	<input type="checkbox"/> Preston	<input type="checkbox"/> Jefferson	<input type="checkbox"/> Tyler	<input type="checkbox"/> Upshur		<input type="checkbox"/> Summers	
		<input type="checkbox"/> Wirt	<input type="checkbox"/> Taylor	<input type="checkbox"/> Mineral	<input type="checkbox"/> Wetzel	<input type="checkbox"/> Webster			
		<input type="checkbox"/> Wood		<input type="checkbox"/> Morgan					

## Asphalt Materials Delivery Labor by Vendor by County

### ATTACHMENT D - Shoulder Stone Plants (ATT D)

Vendor Instructions: Vendor shall enter below the sourced STONE Plant Names and Locations stone may be pulled from under this contract, including their 911 address(es). Vendor must list with each sourced Plant Name and Location listed the counties that plant will be used to service for this contract. Reference Section 6.3 for additional information. If additional space is needed to list additional plant locations, Vendor shall submit multiple Attachment D (ATT D) pages to ensure all plants are accounted for under this contract. Bids submissions that do not include ATT A, ATT B, ATT C and ATT D WILL BE DISQUALIFIED.

**Vendor Name: Kelly Paving, Inc. Plant #23**

Vendor's <b>SHOULDER STONE</b> Plant Location for use with LAYDOWN services:									
Plant Name:		Plant #23 Weirton							
Plant Location:		4260 Freedom Way, Weirton, WV 26062							
Latitude & Longitude Coordinates:		40.38880° N,				80.60000° W			
This plant may service the following counties under this contract:									
<i>District 1</i>	<i>District 2</i>	<i>District 3</i>	<i>District 4</i>	<i>District 5</i>	<i>District 6</i>	<i>District 7</i>	<i>District 8</i>	<i>District 9</i>	<i>District 10</i>
<input type="checkbox"/> Boone	<input type="checkbox"/> Cabell	<input type="checkbox"/> Calhoun	<input type="checkbox"/> Doddridge	<input type="checkbox"/> Berkeley	<input checked="" type="checkbox"/> Brooke	<input type="checkbox"/> Barbour	<input type="checkbox"/> Pendleton	<input type="checkbox"/> Fayette	<input type="checkbox"/> McDowell
<input type="checkbox"/> Clay	<input type="checkbox"/> Lincoln	<input type="checkbox"/> Jackson	<input type="checkbox"/> Harrison	<input type="checkbox"/> Grant	<input checked="" type="checkbox"/> Hancock	<input type="checkbox"/> Braxton	<input type="checkbox"/> Pocahontas	<input type="checkbox"/> Greenbrier	<input type="checkbox"/> Mercer
<input type="checkbox"/> Kanawha	<input type="checkbox"/> Logan	<input type="checkbox"/> Pleasants	<input type="checkbox"/> Marion	<input type="checkbox"/> Hampshire	<input checked="" type="checkbox"/> Marshall	<input type="checkbox"/> Gilmer	<input type="checkbox"/> Randolph	<input type="checkbox"/> Monroe	<input type="checkbox"/> Raleigh
<input type="checkbox"/> Mason	<input type="checkbox"/> Mingo	<input type="checkbox"/> Ritchie	<input type="checkbox"/> Monongalia	<input type="checkbox"/> Hardy	<input checked="" type="checkbox"/> Ohio	<input type="checkbox"/> Lewis	<input type="checkbox"/> Tucker	<input type="checkbox"/> Nicholas	<input type="checkbox"/> Wyoming
<input type="checkbox"/> Putnam	<input type="checkbox"/> Wayne	<input type="checkbox"/> Roane	<input type="checkbox"/> Preston	<input type="checkbox"/> Jefferson	<input checked="" type="checkbox"/> Tyler	<input type="checkbox"/> Upshur		<input type="checkbox"/> Summers	
		<input type="checkbox"/> Wirt	<input type="checkbox"/> Taylor	<input type="checkbox"/> Mineral	<input checked="" type="checkbox"/> Wetzel	<input type="checkbox"/> Webster			
		<input type="checkbox"/> Wood		<input type="checkbox"/> Morgan					

Vendor's <b>SHOULDER STONE</b> Plant Location for use with LAYDOWN services:									
Plant Name:									
Plant Location:									
Latitude & Longitude Coordinates:									
This plant may service the following counties under this contract:									
<i>District 1</i>	<i>District 2</i>	<i>District 3</i>	<i>District 4</i>	<i>District 5</i>	<i>District 6</i>	<i>District 7</i>	<i>District 8</i>	<i>District 9</i>	<i>District 10</i>
<input type="checkbox"/> Boone	<input type="checkbox"/> Cabell	<input type="checkbox"/> Calhoun	<input type="checkbox"/> Doddridge	<input type="checkbox"/> Berkeley	<input type="checkbox"/> Brooke	<input type="checkbox"/> Barbour	<input type="checkbox"/> Pendleton	<input type="checkbox"/> Fayette	<input type="checkbox"/> McDowell
<input type="checkbox"/> Clay	<input type="checkbox"/> Lincoln	<input type="checkbox"/> Jackson	<input type="checkbox"/> Harrison	<input type="checkbox"/> Grant	<input type="checkbox"/> Hancock	<input type="checkbox"/> Braxton	<input type="checkbox"/> Pocahontas	<input type="checkbox"/> Greenbrier	<input type="checkbox"/> Mercer
<input type="checkbox"/> Kanawha	<input type="checkbox"/> Logan	<input type="checkbox"/> Pleasants	<input type="checkbox"/> Marion	<input type="checkbox"/> Hampshire	<input type="checkbox"/> Marshall	<input type="checkbox"/> Gilmer	<input type="checkbox"/> Randolph	<input type="checkbox"/> Monroe	<input type="checkbox"/> Raleigh
<input type="checkbox"/> Mason	<input type="checkbox"/> Mingo	<input type="checkbox"/> Ritchie	<input type="checkbox"/> Monongalia	<input type="checkbox"/> Hardy	<input type="checkbox"/> Ohio	<input type="checkbox"/> Lewis	<input type="checkbox"/> Tucker	<input type="checkbox"/> Nicholas	<input type="checkbox"/> Wyoming
<input type="checkbox"/> Putnam	<input type="checkbox"/> Wayne	<input type="checkbox"/> Roane	<input type="checkbox"/> Preston	<input type="checkbox"/> Jefferson	<input type="checkbox"/> Tyler	<input type="checkbox"/> Upshur		<input type="checkbox"/> Summers	
		<input type="checkbox"/> Wirt	<input type="checkbox"/> Taylor	<input type="checkbox"/> Mineral	<input type="checkbox"/> Wetzel	<input type="checkbox"/> Webster			
		<input type="checkbox"/> Wood		<input type="checkbox"/> Morgan					