



Purchasing Division
 2019 Washington Street East
 Post Office Box 50130
 Charleston, WV 25305-0130

State of West Virginia
 Solicitation Response

Proc Folder : 302042

Solicitation Description : ADDENDUM 2: DATA LOGGING SYSTEM 6317B41

Proc Type : Agency Contract - Fixed Amt

Date Issued	Solicitation Closes	Solicitation Response	Version
	2017-03-14 13:30:00	SR 0803 ESR03141700000004353	1

VS0000012111

Stonehenge Properties, Ltd
 Revcord

Solicitation Number: ARFQ 0803 DOT1700000016

Total Bid : \$4,522.00

Response Date: 2017-03-14

Response Time: 12:45:50

Comments:

Thank you for reviewing our proposal. Revcord's simplistic go to market approach provides buyers easy purchasing decisions. Revcord provides for an all-inclusive product that gives you "The Best Voice Logging Value On The Market Today!" Revcord also provides the richest support program in the industry with RevShield. RevShield provides for support, on-site service, 24/7 monitoring, the RevShield Suite of Software, training, and patches. In addition, Revcord has support for installation under its BOSS program. With a five year hardware warranty and a 100% Satisfaction Guarantee, there is no risk! If you are not 100% satisfied within the first 30 days, we will come pick the logger up...no questions asked and provide 100% of your money back.
 We look forward to providing you the best logger on the market today.

FOR INFORMATION CONTACT THE BUYER

Dusty J Smith
 (304) 558-9398
 dusty.j.smith@wv.gov

Signature on File

FEIN #

DATE

All offers subject to all terms and conditions contained in this solicitation

Line	Comm Ln Desc	Qty	Unit Issue	Unit Price	Ln Total Or Contract Amount
1	VOICE RECORDING DATA LOGGING SYSTEM	1.00000	LS	\$3,522.000000	\$3,522.00

Comm Code	Manufacturer	Specification	Model #
43220000			

Extended Description : VOICE RECORDING DATA LOGGING SYSTEM

Comments: Revcord Multimedia Logging Recorder
8 - VoIP Recording Channel Licenses
Unlimited Playback Licenses
Unlimited Live Recall Licenses
Unlimited Quality Assurance Licenses

Line	Comm Ln Desc	Qty	Unit Issue	Unit Price	Ln Total Or Contract Amount
2	INSTALLATION TRAINING				\$1,000.00

Comm Code	Manufacturer	Specification	Model #
43220000			

Extended Description : INSTALLATION TRAINING
Service period will be 2 weeks from Start Date to install.

Comments: Revcord Premium Installation and End User Training.



Purchasing Division
 2019 Washington Street East
 Post Office Box 50130
 Charleston, WV 25305-0130

**State of West Virginia
 Solicitation Response**

Proc Folder : 302042

Solicitation Description : ADDENDUM 2: DATA LOGGING SYSTEM 6317B41

Proc Type : Agency Contract - Fixed Amt

Date Issued	Solicitation Closes	Solicitation Response	Version
	2017-03-14 13:30:00	SR 0803 ESR03141700000004353	1

VS0000012111
 Stonehenge Properties, Ltd
 Revcord

Solicitation Number: ARFQ 0803 DOT1700000016

Total Bid : \$4,522.00

Response Date: 2017-03-14

Response Time: 12:45:50

Comments:

Thank you for reviewing our proposal. Revcord's simplistic go to market approach provides buyers easy purchasing decisions. Revcord provides for an all-inclusive product that gives you "The Best Voice Logging Value On The Market Today!" Revcord also provides the richest support program in the industry with RevShield. RevShield provides for support, on-site service, 24/7 monitoring, the RevShield Suite of Software, training, and patches. In addition, Revcord has support for installation under its BOSS program. With a five year hardware warranty and a 100% Satisfaction Guarantee, there is no risk! If you are not 100% satisfied within the first 30 days, we will come pick the logger up...no questions asked and provide 100% of your money back.
 We look forward to providing you the best logger on the market today.

FOR INFORMATION CONTACT THE BUYER

Dusty J Smith
 (304) 558-9398
 dusty.j.smith@wv.gov

Signature on File

FEIN #

DATE

All offers subject to all terms and conditions contained in this solicitation

Line	Comm Ln Desc	Qty	Unit Issue	Unit Price	Ln Total Or Contract Amount
1	VOICE RECORDING DATA LOGGING SYSTEM	1.00000	LS	\$3,522.000000	\$3,522.00

Comm Code	Manufacturer	Specification	Model #
43220000			

Extended Description : VOICE RECORDING DATA LOGGING SYSTEM

Comments: Revcord Multimedia Logging Recorder
8 - VoIP Recording Channel Licenses
Unlimited Playback Licenses
Unlimited Live Recall Licenses
Unlimited Quality Assurance Licenses

Line	Comm Ln Desc	Qty	Unit Issue	Unit Price	Ln Total Or Contract Amount
2	INSTALLATION TRAINING				\$1,000.00

Comm Code	Manufacturer	Specification	Model #
43220000			

Extended Description : INSTALLATION TRAINING
Service period will be 2 weeks from Start Date to install.

Comments: Revcord Premium Installation and End User Training.



**State of West Virginia
Request For Quotation**

Procurement Folder : 302042

Document Description : ADDENDUM 2: DATA LOGGING SYSTEM 6317B41

Procurement Type : Agency Contract - Fixed Amt

Date Issued	Solicitation Closes	Solicitation No	Version	Phase
2017-03-03	2017-03-14 13:30:00	ARFQ 0803 DOT1700000016	3	Final

FINANCE & ADMINISTRATION DIVISION OF HIGHWAYS BLDG 5, RM A-220 1900 KANAWHA BLVD E CHARLESTON US	WV 25302	Vendor Name, Address and Telephone Revcord 10190 Katy Freeway Suite: 501 Houston, TX 77043
---	----------	---

ESR031417#
4353

FOR INFORMATION CONTACT THE

Dusty J Smith
 (304) 558-9398
 dusty.j.smith@wv.gov

Signature X

Mich. Harris

FEIN #

76-0631301

DATE

3/14/2017

All offers subject to all terms and conditions contained in this solicitation

ADDITIONAL INFORMATION:

INVOICE TO

DIVISION OF HIGHWAYS INFORMATION SERVICE DIVISION 1900 KANAWHA BLVD E, BLDG 5 RM 920 CHARLESTON WV25305-0430 US	DIVISION OF HIGHWAYS INFORMATION SERVICE DIVISION 1900 KANAWHA BLVD E, BLDG 5 RM 920 CHARLESTON WV 25305-0430 US
---	--

Line	Commodity Line Description	Qty	Unit Issue	Unit Price	Total Price
1	VOICE RECORDING DATA LOGGING SYSTEM	1.00000	LS	\$ 3,522.00	\$ 3,522.00

Commodity Code	Manufacturer	Model #	Specification
43220000	Revcord	MCS-08-VoIP	8 Channel Multimedia Logging Recorder

Extended Description
VOICE RECORDING DATA LOGGING SYSTEM

INVOICE TO	SHIP TO
DIVISION OF HIGHWAYS INFORMATION SERVICE DIVISION 1900 KANAWHA BLVD E, BLDG 5 RM 920 CHARLESTON WV25305-0430 US	DIVISION OF HIGHWAYS INFORMATION SERVICE DIVISION 1900 KANAWHA BLVD E, BLDG 5 RM 920 CHARLESTON WV 25305-0430 US

Line	Commodity Line Description	Qty	Unit Issue	Unit Price	Total Price
2	INSTALLATION TRAINING	1	Ea	\$ 1,000.00	\$ 1,000.00

Commodity Code	Manufacturer	Model #	Specification
43220000	Revcord	BOSSPR	Installation and User Training

Extended Description
INSTALLATION TRAINING
Service period will be 2 weeks from Start Date to install.

SCHEDULE OF EVENTS

Line	Event	Event Date
1	DEADLINE FOR QUESTIONS 5PM	2017-03-07

DESIGNATED CONTACT: Vendor appoints the individual identified in this Section as the Contract Administrator and the initial point of contact for matters relating to this Contract.

Mike Hanner / Vice President Sales and Marketing

(Name, Title)

Mike Hanner / Vice President Sales and Marketing

(Printed Name and Title)

10190 Katy Freeway, Suite: 501, Houston, TX 77043

(Address)

281-404-7040 Ext. 340

(Phone Number) / (Fax Number)

mhanner@revcord.com

(E-mail address)

CERTIFICATION AND SIGNATURE: By signing below, or submitting documentation through wvOASIS, I certify that I have reviewed this Solicitation in its entirety; that I understand the requirements, terms and conditions, and other information contained herein; that this bid, offer or proposal constitutes an offer to the State that cannot be unilaterally withdrawn; that the product or service proposed meets the mandatory requirements contained in the Solicitation for that product or service, unless otherwise stated herein; that the Vendor accepts the terms and conditions contained in the Solicitation, unless otherwise stated herein; that I am submitting this bid, offer or proposal for review and consideration; that I am authorized by the vendor to execute and submit this bid, offer, or proposal, or any documents related thereto on vendor's behalf; that I am authorized to bind the vendor in a contractual relationship; and that to the best of my knowledge, the vendor has properly registered with any State agency that may require registration.

Revcord

(Company)



Vice President of Sales and Marketing

(Authorized Signature) (Representative Name, Title)

Mike Hanner / Vice President Sales and Marketing

(Printed Name and Title of Authorized Representative)

3/14/2017

(Date)

281-404-7040 Ext. 340

(Phone Number) (Fax Number)

ADDENDUM ACKNOWLEDGEMENT FORM

SOLICITATION NO.:

Instructions: Please acknowledge receipt of all addenda issued with this solicitation by completing this addendum acknowledgment form. Check the box next to each addendum received and sign below. Failure to acknowledge addenda may result in bid disqualification. Acknowledgment: I hereby acknowledge receipt of the following addenda and have made the necessary revisions to my proposal, plans and/or specification, etc.

Addendum Numbers Received:

(Check the box next to each addendum received)

- | | |
|--|--|
| <input checked="" type="checkbox"/> Addendum No. 1 | <input type="checkbox"/> Addendum No. 6 |
| <input checked="" type="checkbox"/> Addendum No. 2 | <input type="checkbox"/> Addendum No. 7 |
| <input type="checkbox"/> Addendum No. 3 | <input type="checkbox"/> Addendum No. 8 |
| <input type="checkbox"/> Addendum No. 4 | <input type="checkbox"/> Addendum No. 9 |
| <input type="checkbox"/> Addendum No. 5 | <input type="checkbox"/> Addendum No. 10 |

I understand that failure to confirm the receipt of addenda may be cause for rejection of this bid. I further understand that any verbal representation made or assumed to be made during any oral discussion held between Vendor's representatives and any state personnel is not binding. Only the information issued in writing and added to the specifications by an official addendum is binding.

Revcord

Company

Mich Harris

Authorized Signature

3/14/2017

Date

NOTE: This addendum acknowledgement should be submitted with the bid to expedite document processing.

State of West Virginia

VENDOR PREFERENCE CERTIFICATE

Certification and application is hereby made for Preference in accordance with **West Virginia Code, §5A-3-37**. (Does not apply to construction contracts). **West Virginia Code, §5A-3-37**, provides an opportunity for qualifying vendors to request (at the time of bid) preference for their residency status. Such preference is an evaluation method only and will be applied only to the cost bid in accordance with the **West Virginia Code**. This certificate for application is to be used to request such preference. The Purchasing Division will make the determination of the Vendor Preference, if applicable.

1. **Application is made for 2.5% vendor preference for the reason checked:**
 Bidder is an individual resident vendor and has resided continuously in West Virginia for four (4) years immediately preceding the date of this certification; **or**,
 Bidder is a partnership, association or corporation resident vendor and has maintained its headquarters or principal place of business continuously in West Virginia for four (4) years immediately preceding the date of this certification;
 Bidder is a resident vendor partnership, association, or corporation with at least eighty percent of ownership interest of bidder held by another entity that meets the applicable four year residency requirement; **or**,
 Bidder is a nonresident vendor which has an affiliate or subsidiary which employs a minimum of one hundred state residents and which has maintained its headquarters or principal place of business within West Virginia continuously for the four (4) years immediately preceding the date of this certification; **or**,
2. **Application is made for 2.5% vendor preference for the reason checked:**
 Bidder is a resident vendor who certifies that, during the life of the contract, on average at least 75% of the employees working on the project being bid are residents of West Virginia who have resided in the state continuously for the two years immediately preceding submission of this bid; **or**,
3. **Application is made for 2.5% vendor preference for the reason checked:**
 Bidder is a nonresident vendor that employs a minimum of one hundred state residents, or a nonresident vendor which has an affiliate or subsidiary which maintains its headquarters or principal place of business within West Virginia and employs a minimum of one hundred state residents, and for purposes of producing or distributing the commodities or completing the project which is the subject of the bidder's bid and continuously over the entire term of the project, on average at least seventy-five percent of the bidder's employees or the bidder's affiliate's or subsidiary's employees are residents of West Virginia who have resided in the state continuously for the two immediately preceding years and the vendor's bid; **or**,
4. **Application is made for 5% vendor preference for the reason checked:**
 Bidder meets either the requirement of both subdivisions (1) and (2) or subdivision (1) and (3) as stated above; **or**,
5. **Application is made for 3.5% vendor preference who is a veteran for the reason checked:**
 Bidder is an individual resident vendor who is a veteran of the United States armed forces, the reserves or the National Guard and has resided in West Virginia continuously for the four years immediately preceding the date on which the bid is submitted; **or**,
6. **Application is made for 3.5% vendor preference who is a veteran for the reason checked:**
 Bidder is a resident vendor who is a veteran of the United States armed forces, the reserves or the National Guard, if, for purposes of producing or distributing the commodities or completing the project which is the subject of the vendor's bid and continuously over the entire term of the project, on average at least seventy-five percent of the vendor's employees are residents of West Virginia who have resided in the state continuously for the two immediately preceding years.
7. **Application is made for preference as a non-resident small, women- and minority-owned business, in accordance with West Virginia Code §5A-3-59 and West Virginia Code of State Rules.**
 Bidder has been or expects to be approved prior to contract award by the Purchasing Division as a certified small, women- and minority-owned business.

Bidder understands if the Secretary of Revenue determines that a Bidder receiving preference has failed to continue to meet the requirements for such preference, the Secretary may order the Director of Purchasing to: (a) rescind the contract or purchase order; or (b) assess a penalty against such Bidder in an amount not to exceed 5% of the bid amount and that such penalty will be paid to the contracting agency or deducted from any unpaid balance on the contract or purchase order.

By submission of this certificate, Bidder agrees to disclose any reasonably requested information to the Purchasing Division and authorizes the Department of Revenue to disclose to the Director of Purchasing appropriate information verifying that Bidder has paid the required business taxes, provided that such information does not contain the amounts of taxes paid nor any other information deemed by the Tax Commissioner to be confidential.

Bidder hereby certifies that this certificate is true and accurate in all respects; and that if a contract is issued to Bidder and if anything contained within this certificate changes during the term of the contract, Bidder will notify the Purchasing Division in writing immediately.

Bidder: Revoord

Signed: Mick Harris

Date: 3/14/2017

Title: Vice President of Sales & Marketing

*Check any combination of preference consideration(s) indicated above, which you are entitled to receive.

STATE OF WEST VIRGINIA
Purchasing Division

PURCHASING AFFIDAVIT

MANDATE: Under W. Va. Code §5A-3-10a, no contract or renewal of any contract may be awarded by the state or any of its political subdivisions to any vendor or prospective vendor when the vendor or prospective vendor or a related party to the vendor or prospective vendor is a debtor and: (1) the debt owed is an amount greater than one thousand dollars in the aggregate; or (2) the debtor is in employer default.

EXCEPTION: The prohibition listed above does not apply where a vendor has contested any tax administered pursuant to chapter eleven of the W. Va. Code, workers' compensation premium, permit fee or environmental fee or assessment and the matter has not become final or where the vendor has entered into a payment plan or agreement and the vendor is not in default of any of the provisions of such plan or agreement.

DEFINITIONS:

"Debt" means any assessment, premium, penalty, fine, tax or other amount of money owed to the state or any of its political subdivisions because of a judgment, fine, permit violation, license assessment, defaulted workers' compensation premium, penalty or other assessment presently delinquent or due and required to be paid to the state or any of its political subdivisions, including any interest or additional penalties accrued thereon.

"Employer default" means having an outstanding balance or liability to the old fund or to the uninsured employers' fund or being in policy default, as defined in W. Va. Code § 23-2c-2, failure to maintain mandatory workers' compensation coverage, or failure to fully meet its obligations as a workers' compensation self-insured employer. An employer is not in employer default if it has entered into a repayment agreement with the Insurance Commissioner and remains in compliance with the obligations under the repayment agreement.

"Related party" means a party, whether an individual, corporation, partnership, association, limited liability company or any other form or business association or other entity whatsoever, related to any vendor by blood, marriage, ownership or contract through which the party has a relationship of ownership or other interest with the vendor so that the party will actually or by effect receive or control a portion of the benefit, profit or other consideration from performance of a vendor contract with the party receiving an amount that meets or exceeds five percent of the total contract amount.

AFFIRMATION: By signing this form, the vendor's authorized signer affirms and acknowledges under penalty of law for false swearing (W. Va. Code §61-5-3) that neither vendor nor any related party owe a debt as defined above and that neither vendor nor any related party are in employer default as defined above, unless the debt or employer default is permitted under the exception above.

WITNESS THE FOLLOWING SIGNATURE:

Vendor's Name: Revcord

Authorized Signature: *Mich Harris*

Date: 3/14/2017

State of Texas

County of Harris, to-wit:

Taken, subscribed, and sworn to before me this 14 day of March, 2017.

My Commission expires August 29, 2017.

AFFIX SEAL HERE



NOTARY PUBLIC

Kimberly D. Coleman
Purchasing Affidavit (Revised 08/01/2015)

REVCORD

AND

The State of WV

Division of Highways

*The Best
Multimedia Logging
Value On The Market
Today!*

Table Of Contents

Contents	Section
About Revcord.....	2
Price Quote.....	3
Revcord Software Overview.....	4
Spec Sheet	5
VoIP Upgrade Policy.....	6
RevShield Program.....	7
RevShield Service Level Agreement	8
RevShield Software Suite	9
Warranty Statement	10

2/27/2017

State of West Virginia
Division of Highways
Bldg 5, RM A-220
1900 Kanawha Blvd. E.
Charleston, WV 25302

RE: Data Logging System

Thank you for reviewing our proposal. Revcord's simplistic go to market approach provides buyers easy purchasing decisions. Revcord provides for an all-inclusive product that gives you "The Best Voice Logging Value On The Market Today!"

In addition, below is a list of all the feature sets that are included and are detailed in this document.

- ANI/AU
- Backup Management Software
- Bookmarking and Call Commenting
- Browser Based Client with Multiple Search Capabilities
- Commercial Off The Shelf (COTS) Hardware
- Editing a Call Copy (Redaction)
- Enterprise Operations – Virtual Universal View
- Geo-Tagging
- Incident Recreation
- Inquire Interview Plugin (User Licenses not included)
- Instant Recall Lite and Install Recall Full
- Mobile Call Recording – Android Only
- Multi-Channel Live Monitoring
- Multi Tenancy
- Multimedia Recording Inputs – Analog, Digital, VoIP, Video, Text and Multiple Screens
- Next Generation 9-1-1 (NG9-1-1) I3 Compliant
- Quality Monitoring and Call Taker Evaluation
- Remote Monitoring Service Via RevShield
- Reports and Statistics
- Screen Recording Capture and Free Seating
- Saving and Exporting a Multimedia Files/Playlists
- Trunked Radio Recording And ID Integration As An Option

Revcord also provides the richest support program in the industry with RevShield. RevShield provides for support, on-site service, 24/7 monitoring, the RevShield Suite of Software, training, and patches. In addition, Revcord has support for installation under its BOSS program.

Revcord is considered to be one of the most innovative voice recording companies in the market today. One of the programs we often offer our customers is what we call a "Market Development Discount (MDD)". In an attempt to penetrate certain markets we have a program which provides for additional discounts in order to gain market share. In essence, dollars which would have been spent in advertising or other marketing efforts are passed on as a savings to you. This is a one-time discount, and does not reflect future pricing.

With a five year hardware warranty and a 100% Satisfaction Guarantee, there is no risk! If you are not 100% satisfied within the first 30 days, we will come pick the logger up...no questions asked and provide 100% of your money back.

We look forward to providing you the best logger on the market today.

Regards,



Mike Hanner
Vice President Sales and Marketing

About Revcord

Revcord was formed with the express purpose of taking the Voice Logger technology acquired in 2003 to market. As a result, some \$5 million in R&D investment was acquired at virtually no cost as the exchange was made in private equity. Now, that advantage allows Revcord to offer the finest in voice and multimedia recording systems at the very lowest price available anywhere.

Our vision is to achieve widespread adoption in the government and the creation of new channels in the security, government, public safety and commercial small to medium sized business (SMB) market by delivering an affordable, innovative, and highly scalable voice and multimedia and multimedia logging solution. Revcord's comprehensive call recording and call monitoring solutions enable customers to address the needs of Next Generation 9-1-1 public safety as well as liability and compliance concerns of call centers while ensuring call quality and maximizing operational efficiency. We provide simple, practical and cost effective voice logging options for government organizations and small and medium sized businesses that reduce their expenses, provide state-of-the art integrated multimedia recording, mitigate their risk and enhance the user experience.



Pictured above is the heart of the Revcord system. Voice, video, text and other media can be recorded, searched and replayed. With Call Commenting, ANI/ALI, Dialed Number, Radio ID, Call Tagging, Caller ID, and much more, the Revcord software gives the user the ability to easily find a recording with a User interface that rivals all. Feel free to access our online demo at <http://demo.revcord.com/vrec/>.

Revcord Price Quote

To: State of West Virginia

Solicitation: DOT1700000016

Date: March 7, 2017

Quote #: WV-030717-MH

Customer Ref: State of WV

Expiration Date: June 7, 2017

Salesperson	Shipping Method	Delivery Date	Payment Terms	Payment Due Date
MH	FedEx/UPS	30 Days ARO	NET30	TBD

Qty	Item #	Description	Unit Price	Discount	Line Total
8.00	REVOIPFC	Software For Permanent Fixed VoIP/RoIP Channels - Per Channel	\$325		\$2,600
1.00	MCS	Rackmount Mission Critical Chassis RAID1 Dual Power Supply	\$2,800		\$2,800
1.00	RAID5	MCS Only Upgrade Current Configuration To RAID 5 (4 Hard Drives)	\$1,500		\$1,500
1.00	MISC	Market Development Discount	(\$3,500)		(\$3,500)
MSRP \$ 5,400					

Service					
1.00	BOSSPR	BOSS Premium Onsite Install - First 16 Channels	\$1,000		\$1,000
Total Installation Cost With Discounts					\$1,000

Please note the demarcation point for all digital and analog inputs are dedicated logging blocks that are properly labeled within 60 feet of the recorder location. Any VoIP signaling must be either port mirrored on a dedicated VLAN or sent via a built-in bridge. Networking/cabling to the demarcation point is the customer's responsibility.

Maintenance					
1.00	RSPLUS-UC	RSPLUS Upcharge - First Year 24/7 Help Desk Remote Monitoring	3%	25%	\$122
1.00	RSPLUS	24/7 Help Desk and Remote Monitoring with Updates- Annual	9%	25%	\$365

Item in yellow is annual cost after the first year for maintenance and not included in the total

Total Discount

Total **\$4,522**

Thank you for your business!

10190 Katy Freeway Suite #501
Houston, TX 77043
www.revcord.com



1-866-559-2188
Local 281-404-7040
Fax 281-404-5323

Revcord Software Overview

Revcord Software Overview

Summary

Revcord's Voice and Multimedia Recorder System is the next generation of recorders. Voice, video, text and other media can be recorded, searched and replayed. With Call Commenting, ANI/ALI, Dialed Number, Radio ID, Call Tagging, Caller ID, and much more, the Revcord software gives the user the ability to easily find a recording with a User interface that rivals all.

Table of Contents

<u>Summary</u>	1	<u>RevShield Software Suite</u>	13
<u>ANI/ALI</u>	2	<u>Run as Service</u>	14
<u>Backup Software</u>	2	<u>Reports and Statistics</u>	14
<u>Call Redaction</u>	2	<u>Advanced Reports</u>	15
<u>Cloud Based Recording</u>	3	<u>QA Reports</u>	15
<u>RevStream</u>	4	<u>Mapping Reports</u>	16
<u>RevSync</u>	4	<u>WebUI Logging Module</u>	17
<u>Dashboard Page</u>	4	<u>Text To 9-1-1</u>	17
<u>Enterprise Operations-</u>		<u>Trunked Radio Recording</u>	18
<u>Virtual Universal View</u>	4	<u>Other Feature Sets</u>	21
<u>Full HTML5 Browser Support</u>	5	<u>Bookmarking and Call Commenting</u>	21
<u>Geo Tagging Reports</u>	5	<u>Commercial Off The Shelf (COTS)</u>	
<u>Search Criteria</u>	5	<u>Hardware and Software</u>	21
<u>Playback Geo Tagged Call</u>	6	<u>Multimedia Recording Inupts-</u>	
<u>Incident Recreation</u>	6	<u>Analog, Digital, VoIP and Multiple Screens</u>	21
<u>Inquire Plugin</u>	8	<u>Bookmarks Save with Playlists</u>	22
<u>Instant Recall Lite and Instant Recall Full</u>	8	<u>DSF Player</u>	22
<u>Monitor "Dashboard" and Live Call Control</u>	9	<u>Simplification of Multiple</u>	
<u>Active Screen Being Recorded</u>	10	<u>Revconfig IP Addresses</u>	22
<u>Inquire Live Streams</u>	10	<u>New Integrations</u>	22
<u>Popup for Inactivity</u>	10	<u>Save & Load User Searches</u>	22
<u>Multi Tenancy</u>	10	<u>Saving and Exporting a File</u>	22
<u>Next Generation 9-1-1 (NG9-1-1)</u>	10	<u>Saving and Exporting a Playlist</u>	23
<u>Quality Assurance Evaluation</u>	11	<u>SIP Invite Improvements</u>	23
<u>RevAgent</u>	12		

Revcord Software Overview

ANI/ALI

All Revcord systems come installed with an ANI/ALI module. This module is subject to the supported Revcord dispatch systems (all NENA Standard systems are supported). This provides for a much broader search criteria. As we move to Next Generation 9-1-1, ANI/ALI will be replaced by such technologies as Location Information Service (LIS) and Location to Service Translation (LoST) on a secure IP backbone. Revcord is ready now to accept and record Next Generation IP location information.

Backup Software

The Revcord Backup Manager Service gives you the ability to backup data to various media types as well as set retention periods on how long you want to keep your data onsite. In addition, Revcord provides a Backup Manager client that can run on a remote system and manage multiple recorders with one graphical user interface. Lastly, it will provide for a centralized backup of all data. This provides for enterprise system management.

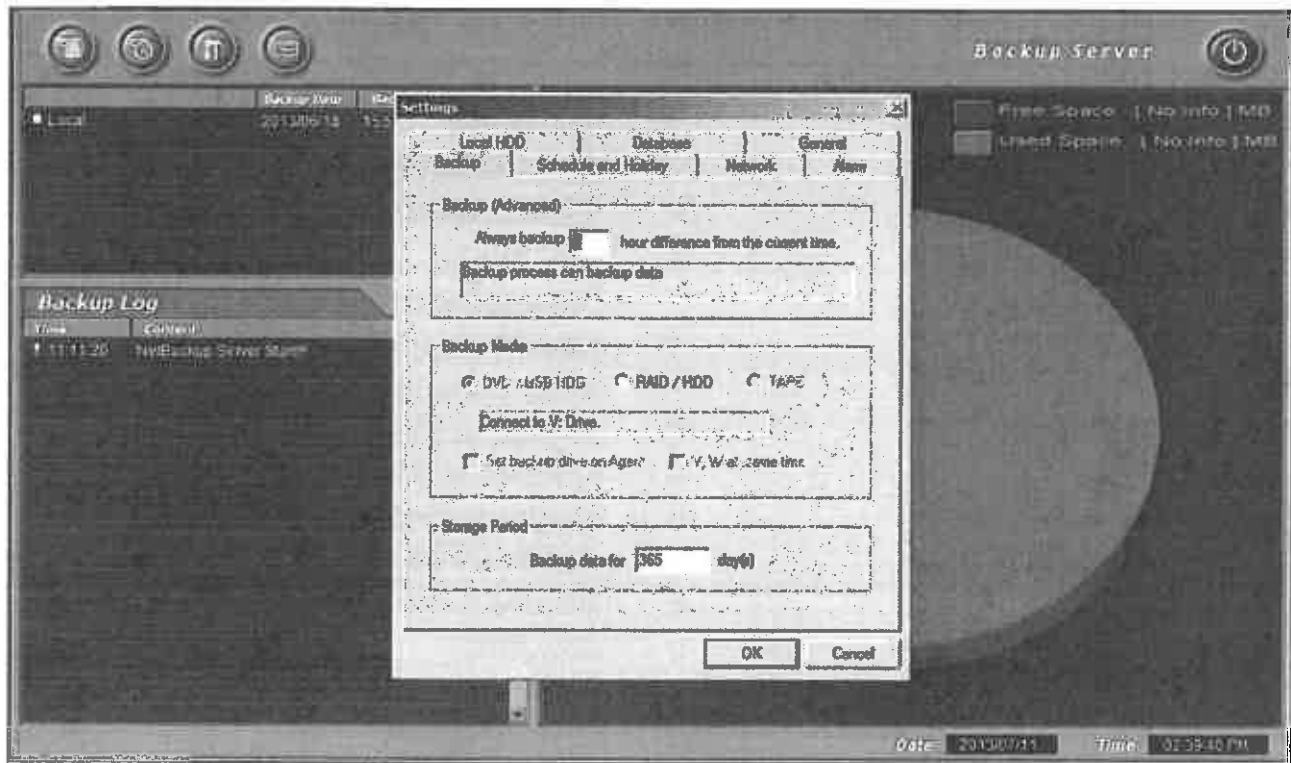

Call Redaction

Revcord provides one of the most advanced editing tools in the industry. The ability to enhance, modify, redact, etc. is a powerful tool in dealing with confidentiality, HIPAA, and PCI type situations.

In addition to the ability to mute, insert white noise or delete sections of a copy of the call, high pass, low pass, notch and band pass filtering can be done on a section of the call or the entire call to eliminate background noise or to isolate a sound of interest.

Revcord Software Overview

Clicking on the red dot next to the play controls allows you to add spoken annotation to a copy of a call either within the same file (overdubbing) or on a completely separate channel.

Please note that the call that is edited does not affect the actual call in the database.

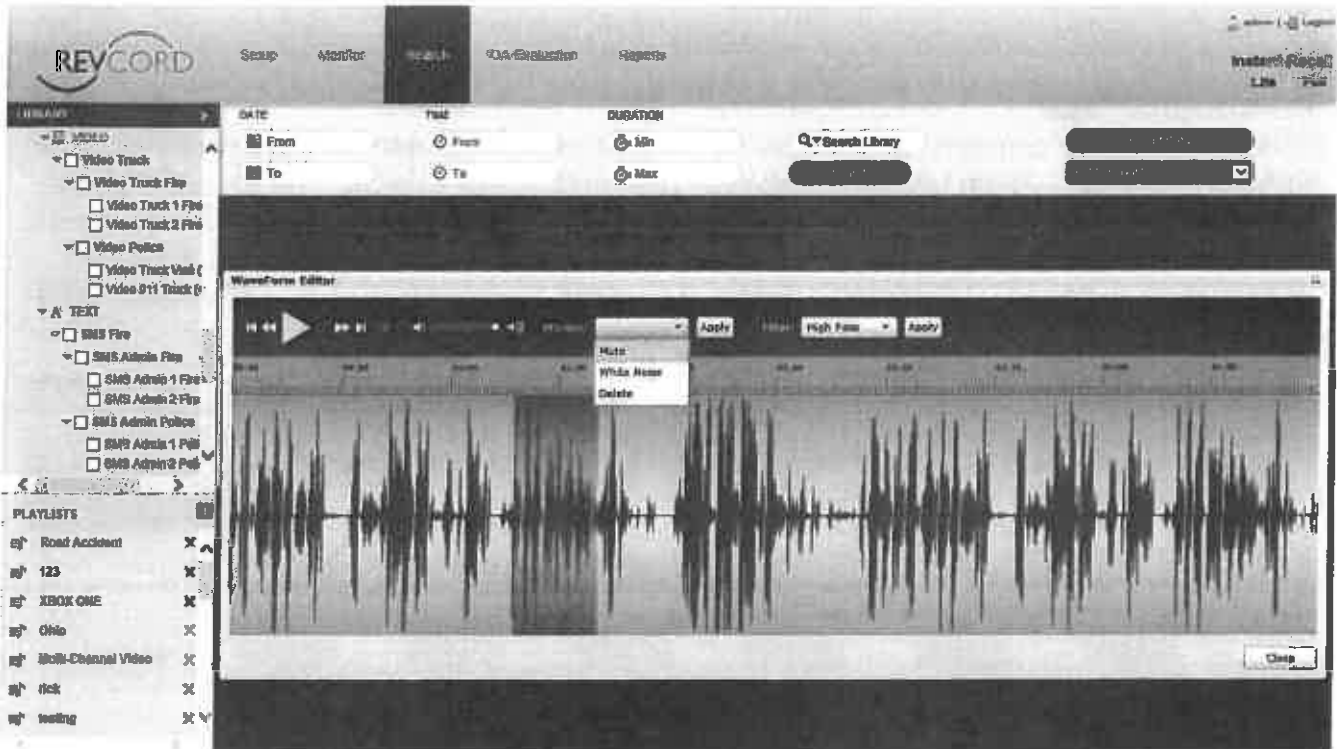

Cloud Based Recording

Revcord has created an application to work with Raspberry pi2 devices. With this device we can stream not only VoIP but also analog signaling to the cloud. The only piece of hardware needed at the facility is a Raspberry pi2 device that is the size of your phone. Everything is stored on the cloud and everything is accessed on the cloud. Enjoy all the features and functionality of the Revcord system without all the hardware and storage hassles.

RevRec is Revcord's API that is the heart of Revcord's cloud introduction. It is the API that connects all the pieces. It acts as an interface that authenticates with Recorder to the cloud and acts as the translator for all video, audio, and data. RevRec uses SSL Integration in its web service with SSL Certification and SHA-256 Encryption/Decryption.

Revcord Software Overview

RevStream

Revcord has teamed up with Amazon Web Services to provide the best in a cloud recording experience.

RevSync

Revcord brings the ultimate backup to our customers. With RevSync and the help of the Raspberry pi2 device, Revcord can provide a redundant real-time copy of your exact multimedia Revcord system. Your system will have an exact copy at all times residing on the cloud.

Dashboard Page

A Dashboard which contains all real-time information providing real-time data of all the major modules of the site. As an example, Today's Total Audio Calls, Videos, Text, Social, Emails and Today Recorded Screens, Active/Inactive Channels, Active Users/Deleted Users, Total Playlists, Exported Playlists, Published/Unpublished QA Forms, QA Evaluations by Status (Schedule, In-Progress, Completed, Closed, Rejected), Shared/Unshared Evaluations, Total Number of Recorders.

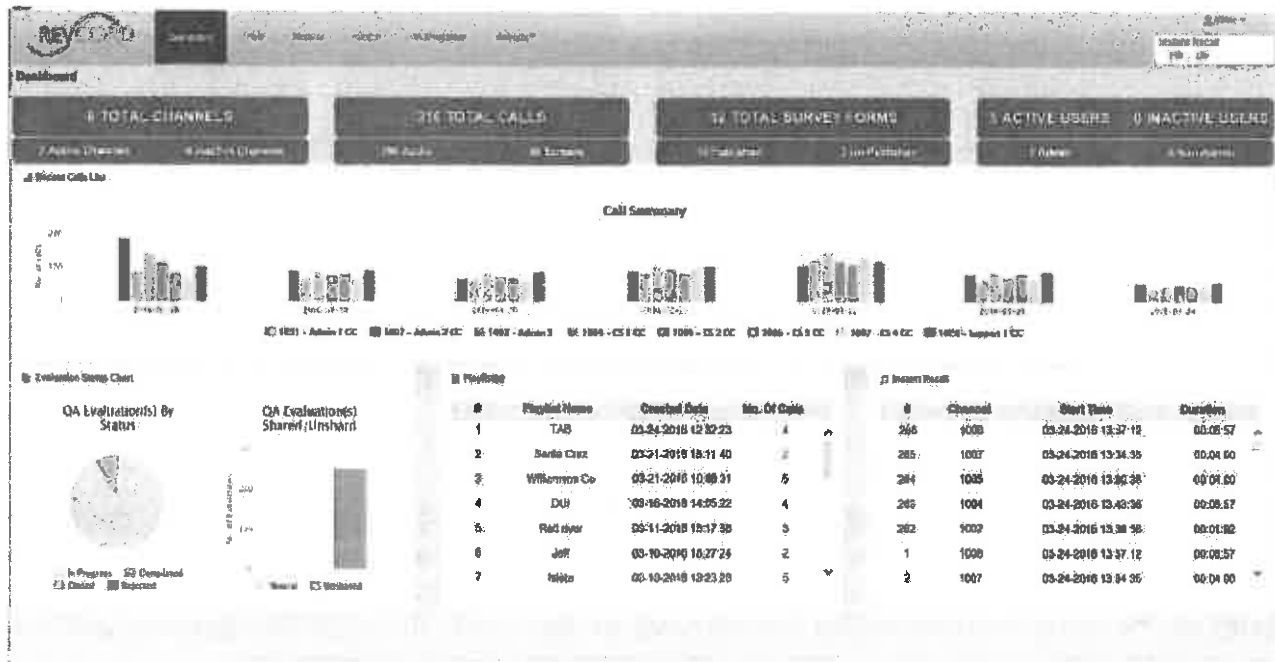

Enterprise Operations – Virtual Universal View

Revcord has the ability to connect anywhere from 2 to 100's of recorders so that there is a single virtual view from one IP address. In addition, each recorder can have an instance of the Revcord Backup Manager and the Revcord Remote Monitoring system running in the background as a service reporting back to a centralized client/server. Below is an example of nine recorders tied together. The nine recorder hardware platform voice recorder system is shown as a single virtual recorder.

Revcord Software Overview

By connecting the nine servers together via a LAN we are able to offer a single monitor view of all channels as shown below. Using the same technology a single Revcord recorder GUI can give the user control of thousands of channels without additional cost.

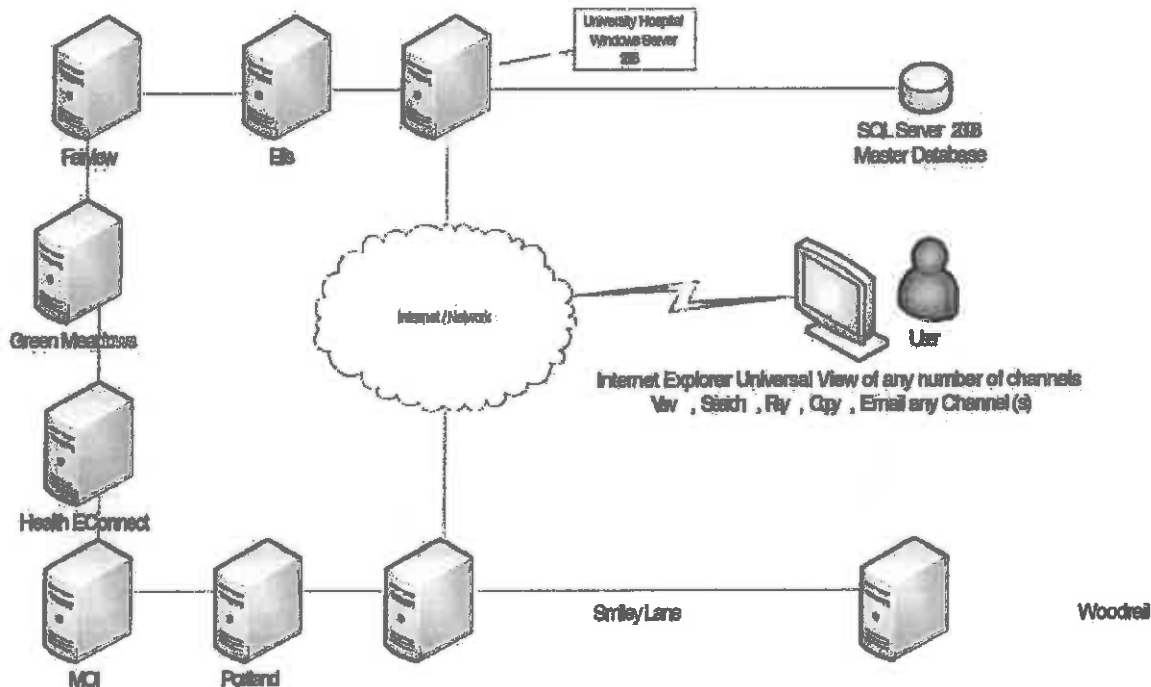

Full HTML5 Browser Support

Revcord now provides for 100% HTML5 support. This means that the Revcord Web UI will work on any HTML5 compliant browser. Use your IPAD, your phone, or your computer. Revcord continues to lead with leading edge technology. In addition for those on RevShield, a Version 9 patch is available.

Geo Tagging Reports

Geo tagging is the process of adding geographical identification metadata to various media such as geo tagged photographs, maps, video, and SMS messages and is a form of geo spatial Meta data. Map reports display a large number of locations or call markers on the basis of ANI/ALI data. Large numbers of markers are converted to clusters using viewport marker management technique.

Search Criteria

Geo tagging reports depend on ANI/ALI data. To search for geo tagging reports you can search for those calls having GPS data. By entering date, time and duration you can produce the map reports just by clicking the "Generate" button. Those calls having GPS data will be marked on map either in the form of call marker (red) or clusters (blue). Each cluster can contain many markers. Each cluster displays number of call markers. To open a cluster, just click it. You will see all call markers under selected/clicked cluster.

Revcord Software Overview

Playback Geo Tagged Call

To play any geo tagged call, you just need to click on call marker. A player popup will open and starts playback automatically. All the player features are available on this popup. In addition to simple player controls you can save, email and edit any geo tagged file.



Incident Recreation

Revcord takes scenario/incident recreation to a new level. And, it's included at no additional cost. For this we use Playlists. You will notice that this idea of Playlists is similar to that of many of the Media Players such as itunes and Windows Media Player. Each Playlist created represents an entire incident including all voice, video, text and other associated media including documents and other media from third party sources. All you do is pick your inputs from the Search Screen and add them to an existing or created Playlist.

ID	Call	Channel Name	Channel ID	Start Time	Stop Name	Duration	Speakers	Comments	Call ID / Stored Number
1	Admin 3 Police	1032	07-09-2013 11:24:10	Admin - Police	00:01:02				
2	Dispatch 2 Fire	1012	07-09-2013 11:24:04	Fire Dispatch	00:01:02				
3	911 Dispatch 1	1027	07-09-2013 11:23:49	911 Dispatch	00:02:02				
4	911 Trunk 1	1024	07-09-2013 11:23:09	911 Trunk	00:01:02				
5	Voice 3 Police	1019	07-09-2013 11:21:03	Voice	00:02:02				
6	CS 4 CC	1007	07-09-2013 11:21:00	Customer Service	00:02:01				
7	Dispatch 2 Fire	1012	07-09-2013 11:20:48	Fire Dispatch					
8	911 Dispatch 2	1026	07-09-2013 11:20:45	911 Dispatch					
9	Admin 3 Police	1022	07-09-2013 11:20:05	Admin - Police					
10	Voice 2 Police	1019	07-09-2013 11:19:02	Voice					
11	CS 2 CC	1005	07-09-2013 11:18:58	Customer Ser.					
12	Admin 1 Police	1020	07-09-2013 11:18:07	Admin - Police					
13	Voice 1 Police	1017	07-09-2013 11:18:03	Voice					
14	Voice 2 Police	1018	07-09-2013 11:18:58	Voice	00:02:02				
15	Admin 1 Fire	1015	07-09-2013 11:18:44	Admin - Fire	00:04:00				
16	Admin 2 Police	1021	07-09-2013 11:18:38	Admin - Police	00:07:56				
17	IA 2 Police	1021	07-09-2013 11:15:47	Internal Affairs	00:07:57				
18	Support 1 CC	1009	07-09-2013 11:15:45	Support	00:04:58				
19	CS 2 CC	1005	07-09-2013 11:14:53	Customer Service	00:02:02				

Revcord Software Overview

There are two view modes to see Playlists. The first is List Mode as shown below.

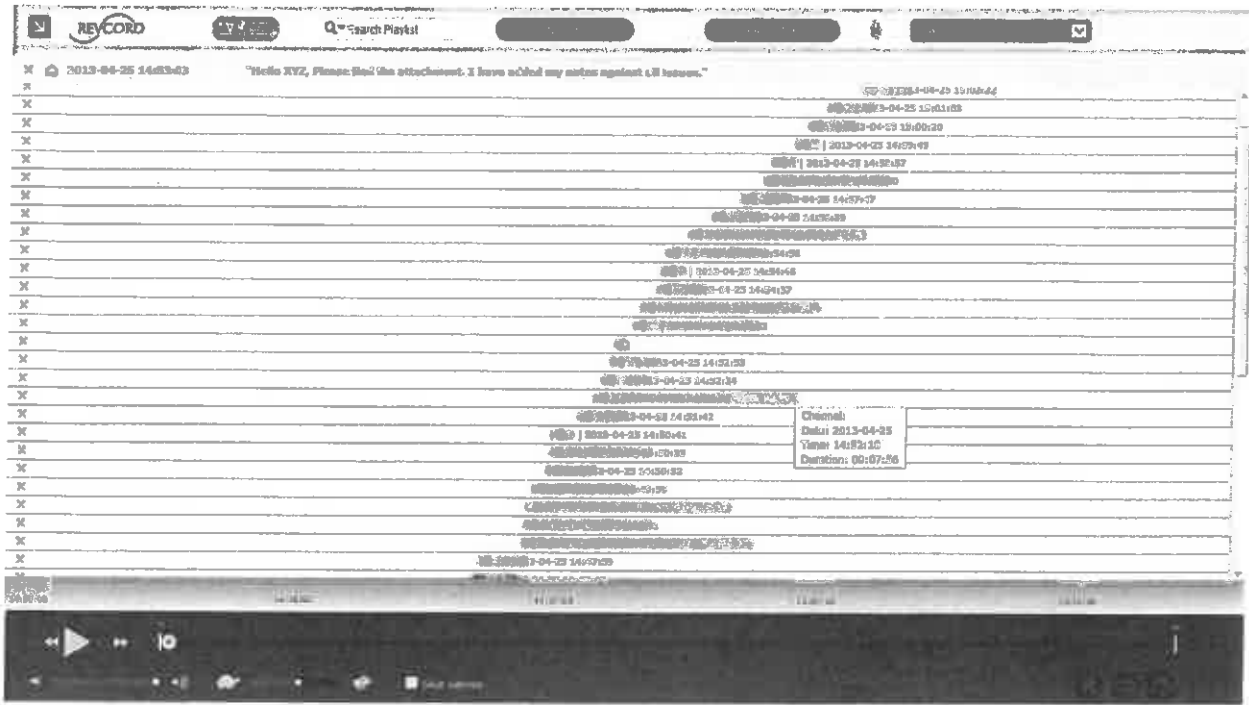

The other mode, which is the Timeline Mode, gives you real time recreation and provides for the playback of all inputs. The Timeline Mode provides for up to four video screens and an unlimited number of audio and text based inputs all playing simultaneously.

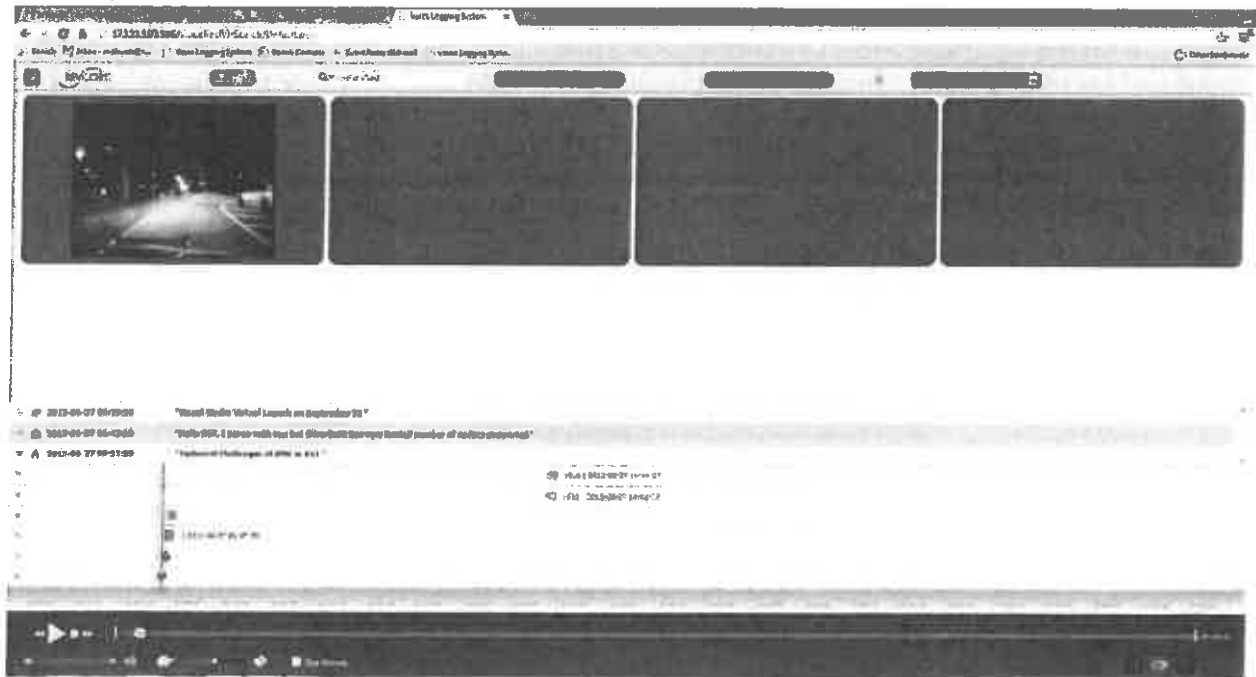

Revcord Software Overview

Any scenario can be displayed and replayed in a time line view as it really happened as well as in a sequential list view. The scenarios can be exported as zip files so they can be viewed without a separate player.

Inquire Plugin

Revcord has written the API plugin for Inquire. Now your Rvcord systems can also act as your management system for all your Interviewing, Investigating, and Inspecting. Inquire creates interviews, investigations, and incidents using a PC, Android, or IOS Application. Stream them live, record with book marks and notes, and automatically upload to the Rvcord Server. Manage all of your interviews, investigations, and incidents in one location. Watch them live or later search on date, time, case ID, interviewer/investigator, interviewee, book marks, book mark notes, GPS location, and device ID. In addition, perform QA evaluations and run reports on any of the Search indices.

Verticals include:

1. Insurance Companies - Document Insurance Claims with Centralized Storage
2. Police Departments - Can be Used for Local and Remote Interviews of Investigations by Police Officers In-Car and Detectives as well as Incident Recording for Documenting Officer's Actions.
3. Child Protective Services
4. Marine Industry - Safety and Compliance Documentation
5. Oil Field Industry - Safety and Compliance Documentation
6. Fire Departments - Used by Fire Arsonist Investigators
7. CSI Investigators - Used by Crime Scene Investigators
8. Inspectors – Any Inspection Type Companies
9. Law Firms - Backup to Depositions

Instant Recall Lite and Install Recall Full

Revcord continues its dedication to simplification and listening to its customers. As such Rvcord will provide legacy functionality of an instant recall with an easy to use simple solution for today's technology. Rvcord provides two view modes. A simple small screen of the most recent recorded calls with a player and one that shows active calls as well. The dual screen provides an excellent view of transitioning calls from active to recorded.

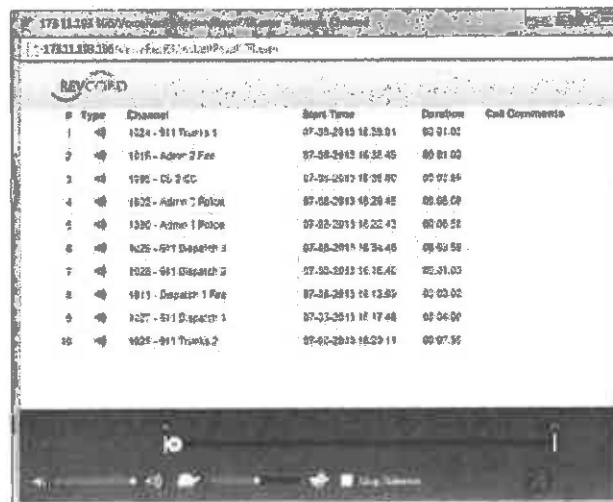

ID	Type	Channel	Start Time	Duration	Call Comments
1	1324 - 911 Truck 1		07-05-2015 18:58:01	00:01:00	
2	1016 - Adm 2 Fax		07-05-2015 16:58:45	00:01:00	
3	1390 - CU 3 CC		07-05-2015 18:08:00	00:01:00	
4	1025 - Adm 7 Police		07-05-2015 18:28:45	00:00:00	
5	1390 - Adm 1 Police		07-05-2015 18:22:42	00:00:55	
6	1025 - 911 Dispatch 3		07-05-2015 18:36:40	00:00:58	
7	1025 - 911 Dispatch 3		07-05-2015 18:36:40	00:01:00	
8	1013 - Dispatch 1 Fax		07-05-2015 18:12:59	00:00:00	
9	1027 - 911 Dispatch 1		07-05-2015 18:17:48	00:00:00	
10	1025 - 911 Trucks 2		07-05-2015 18:29:19	00:07:35	

10190 Katy Freeway Suite #501
Houston, TX 77043
www.revcord.com



Page 8
1-866-559-2188
Local 281-404-7040
Fax 281-404-5323
Version 2: 4-4-2016

Revcord Software Overview

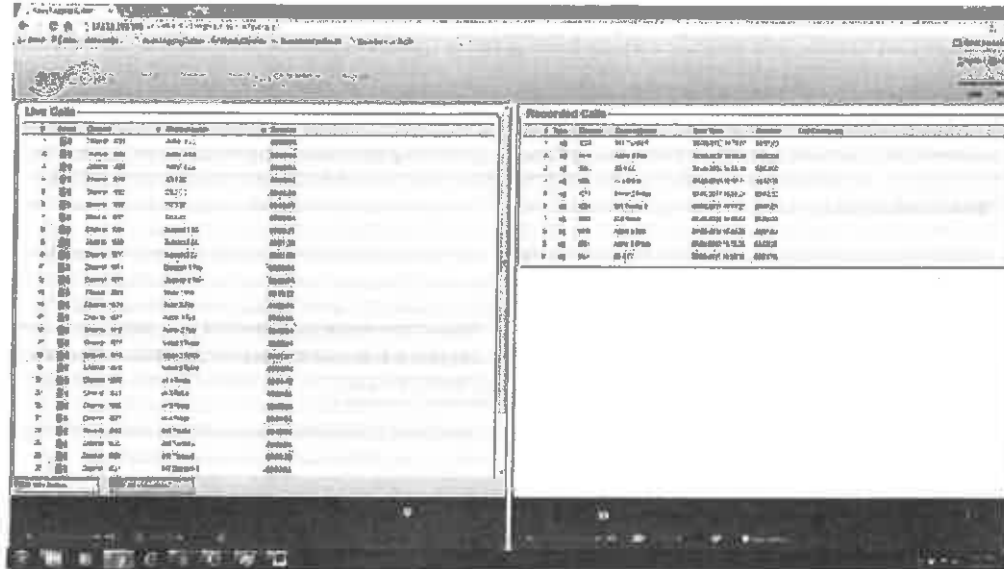

Monitor "Dashboard" and Live Call Control

From the Monitor tab of the Revcord recorder not only can you perform live monitoring, but also you obtain a dashboard view of all call takers. As the call taker receives a call, the channel icon turns to a pink color to indicate "live now". A right click will display a drop down menu that displays those functions for which the call taker has an assigned privilege. With Live Call Control, the user has the ability to do a number of tasks. With the click of a mouse the user (with appropriate privileges) can insert silence for PCI Compliance, initiate Record on Demand, stop a call from recording, Email a call automatically, and tag calls for incident tracking with up to 6 customizable alphanumeric fields. The User can also bookmark any portion of the call. In addition, Live Recall gives the user the ability to be listening to live calls and rewind those calls "on the fly" for up to the last 10 minutes. This feature is great for supervisors to come in after the fact to catch up on a call. If a channel has been idle for a settable period of time the channel turns red in color as a visual alert.

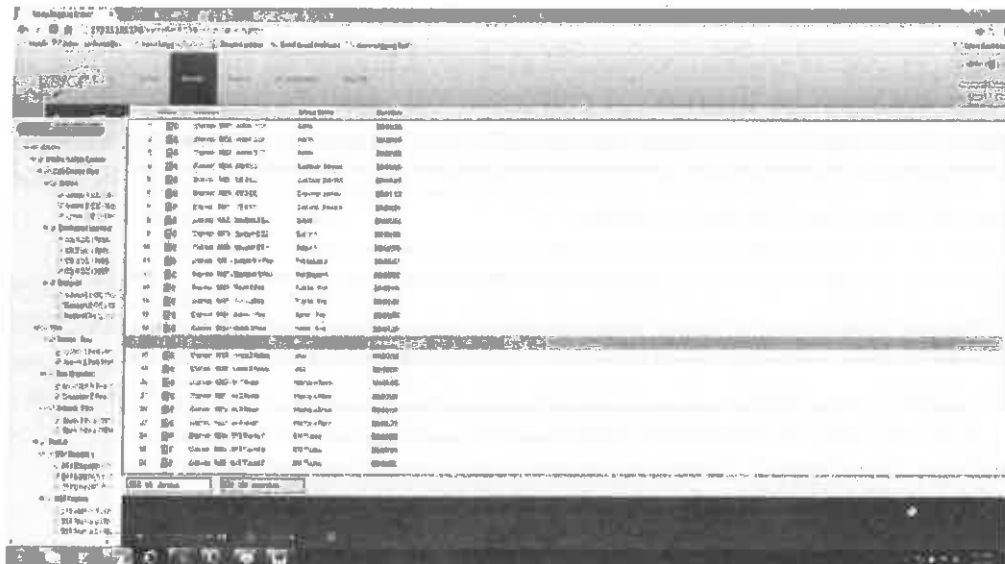

Revcord Software Overview

Active Screen Being Recorded

Ability to see Active Screens being recorded while Active calls are going on.

Inquire Live Streams

View live interviews, inspections, and incidents via the Revcord Monitor tab for any licensed Inquire software device.

Popup for Inactivity

Display popup for selected channels upon inactivity. When a selected channel becomes inactive, a popup will be displayed earlier than sending email to the agent. Where user see's alert pop-up on their screen without having to check email.

Multi Tenancy

Multi-tenancy refers to a principle in software architecture where a single instance of the software runs on a server, serving multiple client organizations (tenants). Revcord with its ability to virtualize its recorders (see Enterprise Slick) and its ability for associating different recorders with different groups provides for multi-tenancy. We commonly see this in executive suites, shared PSAPs, holding companies with multiple subsidiaries, and large departmentalized public and private organizations. This provides for privacy for the various entities while sharing one network of recorders. Configuration is done through the Installation Wizard channel by using the various recorders and channels and associating them with particular groups and users. Different channels on different recorders can be associated to single or multiple users or groups. All this provides for a powerful tool when there is a security need for multiple entities accessing the same recording eco-system.

Next Generation 9-1-1 (NG9-1-1)

Revcord engineers have been deeply involved with Next Generation 9-1-1 since 2007 during the feasibility analysis and initial design with the Department of Transportation and the National Emergency Number Association (NENA). In 2009, Revcord was among the very first two logging recorder vendors to join in ICE (Industry Collaboration Event) and we fully participated in the first ICE formal tests. Our voice logger was completely tested according to the designated protocol. Revcord continued to work on the draft i3 specification until its adoption and publication as Version 1.0 of NENA Technical Standard 08-003, Detailed Functional and Interface Specification for the NENA i3 Solution – Stage 3, in June 2011 and thereafter. We have continued to participate in all subsequent ICE events along with being active in a subsequent special committee.

There are no companies that are certified for NG9-1-1 call recording. Any company that is saying they are certified is providing false statements. There are no final and complete NG9-1-1 specifications. During NENA ICE 8 collaborations which Revcord is a member, it was found that the detail in the i3 document was somewhat lacking in specificity so we formed the separate Revision to NENA Technical Standards Doc# 08-003, Section 5.12 "Recording and Logging Services" committee. With Revcord playing an integral part and a member, that subcommittee has adopted suggested changes to the NENA document that will be considered by the full NENA organization leadership.

Revcord Software Overview

Quality Assurance Evaluation

Quality Assurance Evaluation of calls is also included at no additional cost. The user can easily create score sheets with multiple choice, yes/no or text comments and scores. Calls to be evaluated can be selected manually or at random. In the search screen, any call(s) can be designated for later QA Evaluation with a single click.

ID	Group ID	Group Name	Operator	Agent	QA Type	QA Evaluation Class	Score	Weight
1	1203	Verbs - Pin	admin	User 1013	Good Service	05-21-2013	20 / 20	1.0
2	1206	Support	admin	User 1005	Programming Languages	05-17-2013	200 / 400	0.5
3	1206	Support	admin	User 1009	Programming Languages	05-17-2013	210 / 420	0.5
4	1202	Support	admin	User 1010	Programming Languages	05-17-2013	170 / 420	0.4
5	1206	Customer Service	admin	User 1007	Programming Languages	05-17-2013	210 / 420	0.5
6	1201	Support	admin	User 1010	Programming Languages	05-17-2013	180 / 420	0.4
7	1206	Admin - Poles	admin	User 1022	Programming Languages	05-17-2013	240 / 420	0.6
8	1202	B11 Dispatch	admin	User 1005	Programming Languages	05-17-2013	200 / 420	0.5
9	1203	Ver	admin	User 1010	Programming Languages	05-17-2013	180 / 420	0.4
10	1206	B11 Dispatch	admin	User 1025	Programming Languages	05-18-2013	420 / 420	1.0
11	1221	Support	admin	User 1009	Test Statistics	05-18-2013	10 / 20	0.3
12	1223	Internal Affairs	admin	User 1020	Test Statistics	05-18-2013	20 / 20	0.6
13	1223	Fire Dispatch	admin	User 1011	QA Survey	05-18-2013	100 / 100	1.0
14	1218	Internal Affairs	admin	User 1020	Programming Languages	05-18-2013	420 / 420	1.0
15	1209	Customer Service	admin	User 1005	Admin Test	05-23-2013	20 / 40	0.5

Call Summary

Call Time : 4/10/2013 12:08:21 AM
 Call Duration : 00:01:50
 Channel : 6030
 Agent : 1109

QA Evaluation

QA Evaluation ID : 1171
 No of Questions : 5
 Evaluated Questions : 5
 Evaluated on : 4/10/2013 12:12:51 AM
 Score : 26
 Perfect : 40

Form: Alex Test

Question 1: Did the agent answer the phone with the proper greeting?

Yes
 No

Question 2: Did the agent remain calm during the call?

Yes
 No

Revcord Software Overview

In addition, the following features are included.

1. Ability to search for completed evaluations by agent and/or evaluator
2. Add all agents to dropdown list for easy viewing of completed evaluations (also for choosing an agent to evaluate)
3. Grant the ability to edit or delete published QA forms
4. Supervisor can email completed Evaluations to respective agent or any other concerned. When an evaluation is being marked as completed, then the ability to email completed evaluation to respective agent.
5. Tie video from screen recording or Inquire to evaluation interface
6. Make Drill down graphs clickable to view detail page forms
7. Extend search options to allow for Agent/Channel.
8. **Ability to search for completed evaluations by agent and/or evaluator - To search completed evaluation of specific agent or completed evaluation conducted by any evaluator. Passing the agent name or evaluator name as search parameters will display all the completed evaluations of agent or all the completed evaluations conducted by evaluator.**
9. Ability to import and export templates.
10. Eliminated the redundancies in QA evaluation process. Eliminated the "Pending" evaluation status. In addition, instead of going through multiple pages, a single interface has been introduced which displays list of evaluations based on evaluation status "In Progress", "Completed", "Closed" and "Shared".

RevAgent

RevAgent is a complete upgrade to the previous Revcord Utility Client. RevAgent is a service that resides on the client PC. It provides for a host of services and acts as a liaison between the Revcord server and the client. RevAgent will need to be installed on the individual desktops. It will provide the following functionality:

Audio ROD (Start/Stop Recording)
Triggered Screen Recording By Area
Screen Masking
Screen ROD (Start/Stop Recording)
Triggered Screen Recording By Mouse
Live Streaming
Multi-screen Recording (Up To Four)

Free Seating By Windows User
Full Time Screen Recording
Call Commenting While on Call
Free Seating By Revcord User
Auto Login
Full Session Recording Based On Duration

As an example, Revcord's screen recording enables an agent's or call taker's computer screen (e.g. CAD, GIS) to be recorded synchronized with voice and then transfers the file and updates the database on the server. The screen recording capture works in either of two modes on the Revcord voice logger: Client Mode and Server Mode. In the Client Mode, the recording works with a Record on Demand (ROD) trigger. In this mode the user will have the ability to enable or disable screen capture. In the Server Mode, the screen recording works with any recording trigger, however, the Server Stealth Mode overrides the ROD and continuously records the screen. Playback is simple, performed on the search screen allowing voice or voice and screen playback. Multiple screens, often up to 4 per workstation, are normal in some busy agencies. Revcord can record multiple screens in full time or triggered by events. Multiple screen recording is offered at no additional cost.

Revcord Software Overview

RevShield Software Suite

The RevShield software suite is made up of a server program called RevGuard and a client program called RevWatch. These two software's work hand in hand to monitor your logger as well as to provide secure access that addresses most IT security concerns.

RevGuard

RevGuard is an integrated hardware and software monitoring application that has been handcrafted to monitor your Revcord Voice Logging System components. RevGuard works hand-in-hand with RevWatch. RevWatch is a cloud-based application that manages the alerts and notifications pertaining to the health and status of all systems running RevGuard.

RevWatch

RevWatch is sent signaling that acts as a heartbeat and a report. There is a dashboard that shows a system summary. RevWatch also receives all of the alerts from RevGuard. Please note that RevWatch can also work on closed networks that have no internet ability.

At Revcord, we know security is a leading factor in many IT Departments' decision making. RevGuard was designed and built with keeping Security as a priority. RevGuard does not require any listener sockets or TCP/UDP ports to be created. That means RevGuard is "closed off" to the outside world. In the event of a trigger or alert, an outgoing encrypted signal will be sent via SSL to RevWatch via a User defined outbound port only for base situations. For remote access and support, there are also security protocols in place.

RevGuard alert triggers are also configured locally and are fully customizable. Several aspects can be configured for monitoring: Hard Disk Status, Hard Disk Storage Space, CPU usage, Memory usage, Revcord software processes or stops/crashes, exceptions created by Revcord Processes, Revcord channel activity, and file deletion.

RevGuard notifications/alerts are configured locally, and are fully customizable. There are many different ways in which an alert can be manifested: Email notifications, automatic ticket creation in the Revcord Ticketing System, Remote Assistance Requests, or Taskbar Icon/Balloon messages.

Remote Capabilities

Revcord provides for two modes of remote capability again keeping in mind security as our primary priority: On Demand Mode and Host Mode. On Demand Mode allows for an interactive session to be initiated directly with Support by clicking on an Icon on the Revcord Server or even a User's Workstation. In addition, a User can be sent a link via email or Instant Messaging. Once a remote support session is requested, a Revcord Customer Support Agent or Dealer Technician will be able to connect to the system using a SHA-256 encrypted SSL connection. All Revcord Dealers will have the abilities of RevGuard, RevWatch, and remote support for sites on RevShield. In Host Mode, sessions can be automatically requested as part of an alert, by clicking a link within the Web User Interface, or by double-clicking the Request Remote Support icon on the desktop. Please note that none of the above-mentioned methods require any listener sockets or TCP/UDP ports to be created.

Revcord Software Overview

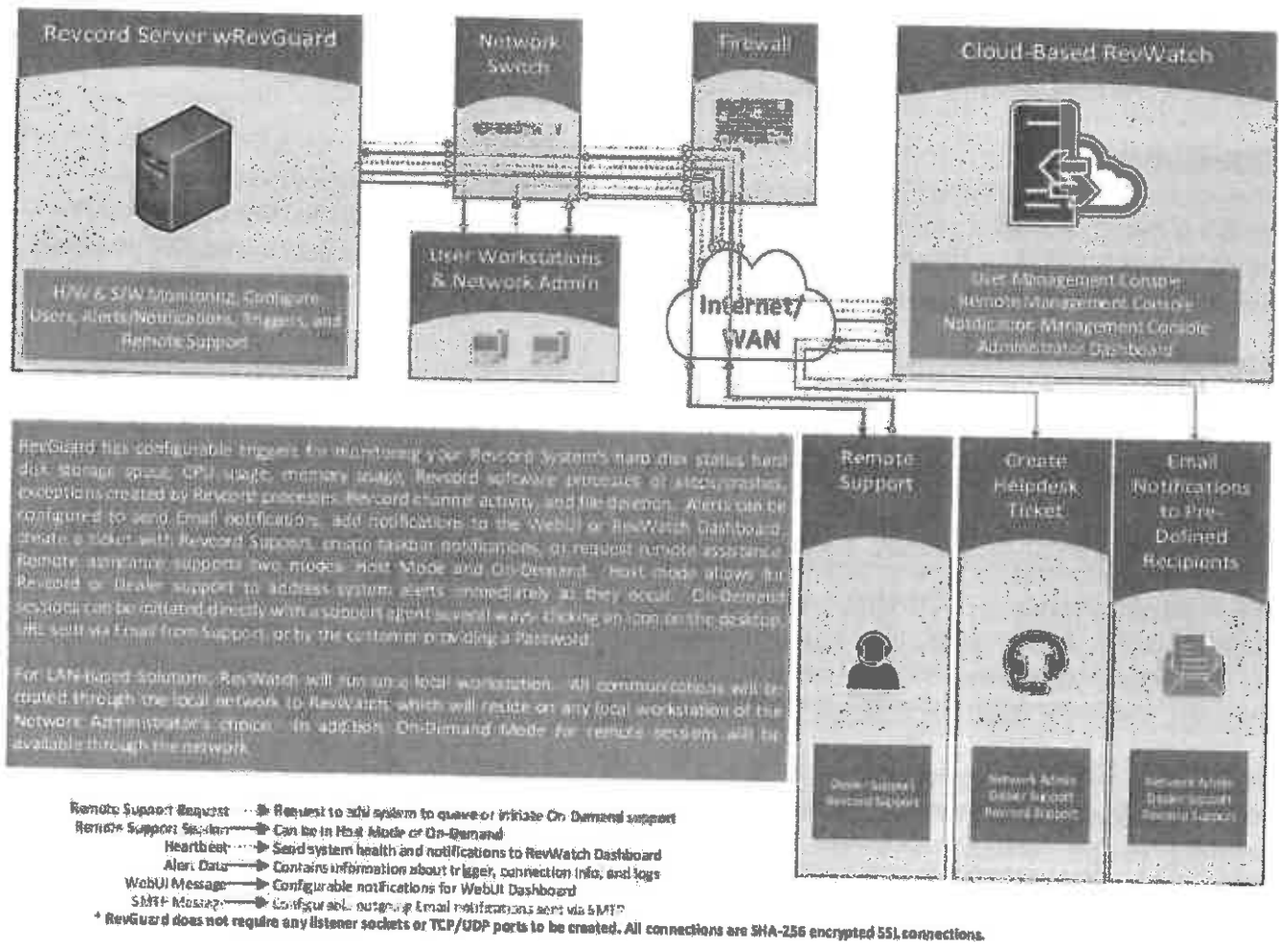

Run as Service

The Revcord software now has the ability to use a Windows service to start and stop the Revcord application. It will monitor all the applications and start and stop based on configurations. There is no need to login as a User. The system will record even when a User is not logged in network components.

Reports and Statistics

Again, without additional cost, Revcord includes a complete Reports and Statistics package. It is made up of four parts: Advanced Reports, QA Reports, Mapping Reports, and Web UI Logging Reports.

Revcord Software Overview

Advanced Reports

With QA and Advanced Reports, you may search and select the calls of interest. Criteria and sort mechanisms can be chosen from simple drop down lists and with a click a familiar Excel spreadsheet is displayed with the details chosen, such as, number of, per call taker, per call duration and average duration and so forth. With another click, the detailed Excel spreadsheet can be exported, and/or the spreadsheet data can be displayed as a bar chart or pie chart that is especially useful for presentations to management.

The screenshot displays a complex data table within the Revcord software. The table has multiple columns, including call identifiers, agent names, and various statistical metrics. The interface includes a sidebar with a tree view of call center categories and a right-hand panel with several control buttons and filters.

QA Reports

Reports can be essential for analysis of call patterns, workforce scheduling and research. Record can save you time and work by producing professional and engaging reports as Excel spreadsheets, bar charts or pie charts which can be exported in multiple formats.

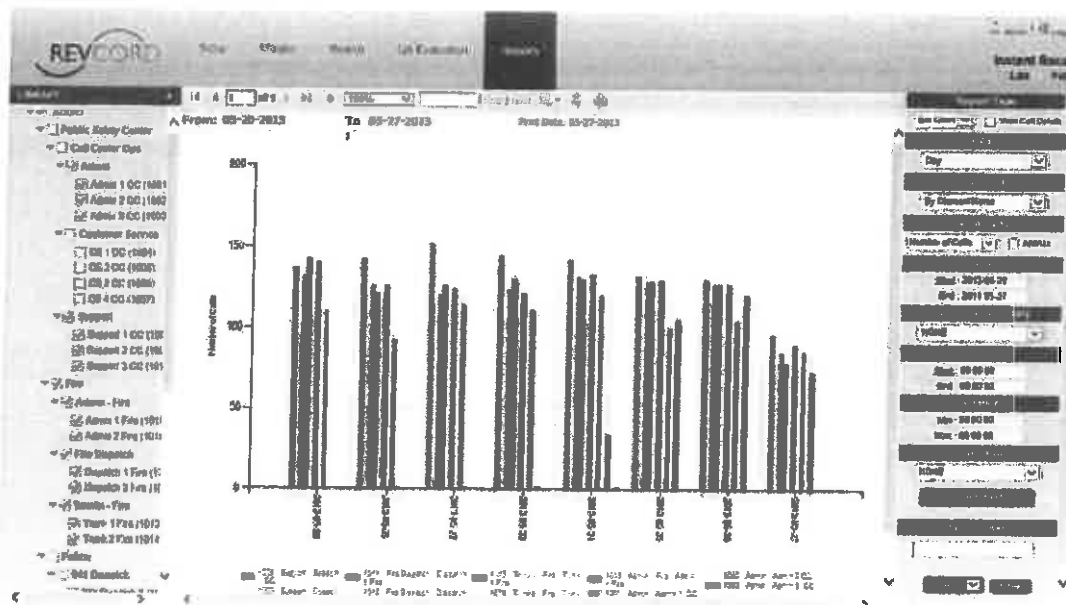

Revcord Software Overview

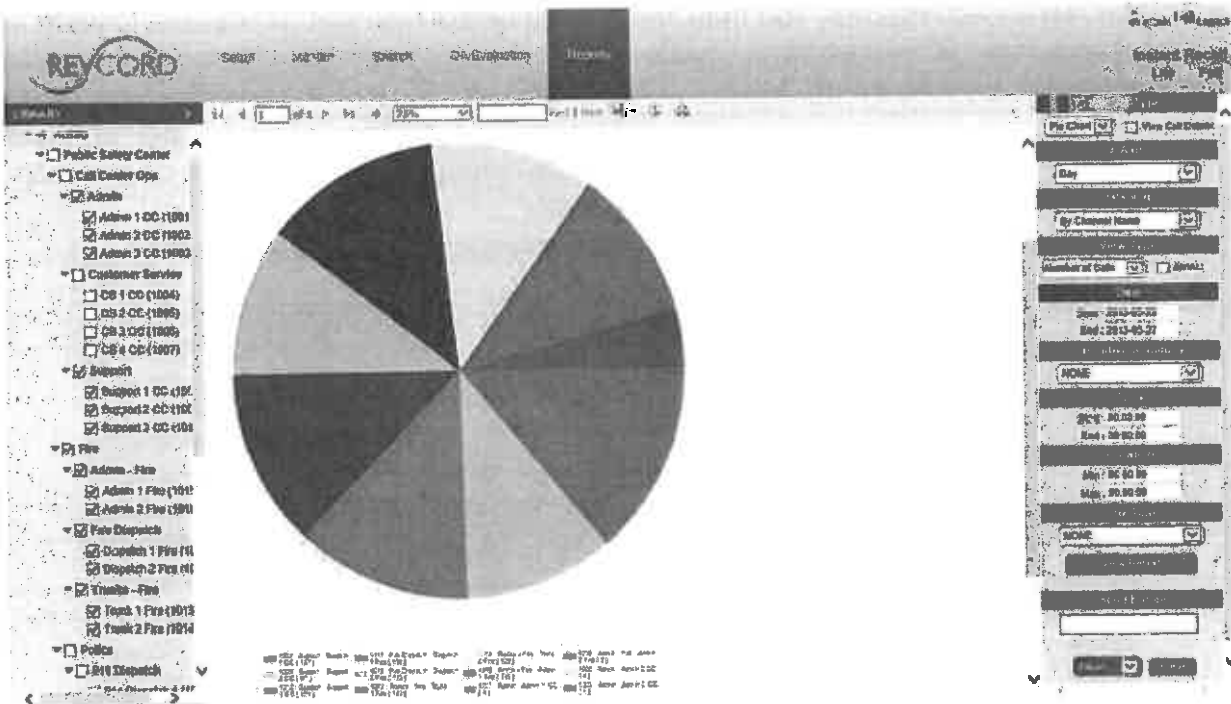

Mapping Reports

Those systems with ANI ALI data can now use the REVCORD Mapping function. REVCORD using the Google Maps API can provide a scenario recreation of how the radio and call traffic happened real time. This can be used to see patterns and specific locations of calls.



Revcord Software Overview

WebUI Logging Module

All the core operations performed by the User will be logged on the server. This logging module contains error logs and other operational logs which were performed by the User during their session. Reports relative to the User sessions are available in the reports module.



Text To 9-1-1

There are a lot of questions surrounding Text to 9-1-1. This document helps understand where the market is and what Revcord has to offer.

TEXT TO 9-1-1 DIAGRAM

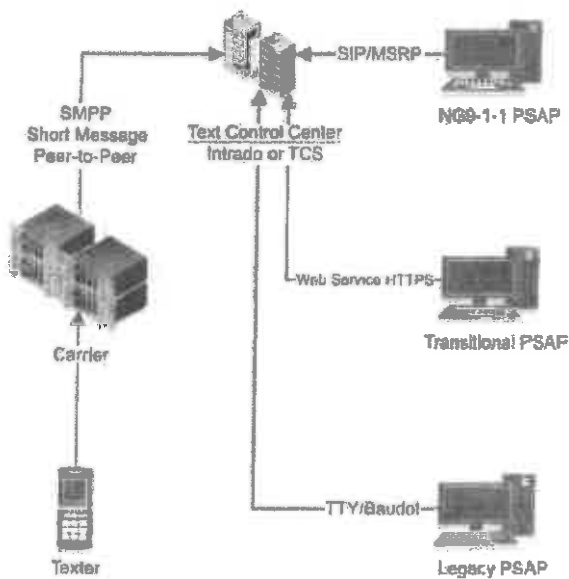

Referring to the **Text To 9-1-1** diagram, all data ends up in a TCC or Text Control Center. Currently there are only two companies which can accept and send data to and from the TCC. The first is Intrado now known as West and the second is TCS which is now known as Comtech Telecommunications Corp. The two TCC providers provide this service to many CPEs as well as their own CPEs.

There are currently three methodologies for getting Text To 9-1-1:

Method 1 (TTY/Baudot)

Recording is currently limited to TeleTYpewriter (TTY) or Telephone Device for the Deaf (TDD) tones (Baudot) that are sent over standard CAMA trunks. The downside is that each text ties up one PSAP trunk.

Method 2 (The Web Solution)

On the way to NG9-1-1 there will be "baby steps" for some of the technologies. For a Transitional PSAP Text to 9-1-1 can be received. Web access via secure Internet or IP network is required. Normally a dedicated browser and monitor would be constantly monitored for text messages. ALI is displayed as the texter's phone number and location currently is the centroid of the cell sector. Recording is done via screen recordings or in some cases a screen scrape of the data.

Revcord Software Overview

Method 3 (MSRP – Full Integration Into The CPE)

This is the “real deal”, sometimes referred to as i3. Everything is IP and all communications, including text are SIP/RTP. This is very complex technically. Revcord has completed testing of i3 NG9-1-1 Text to 9-1-1. In brief, the Text Control Center sends text messages using MSRP (Message Session Relay Protocol) via SIP – much like Instant Messages – to the NG9-1-1 ESInet. Text, like all media is sent via RTP using Real Time Text/RFC4103. Yes, it is highly technical and Revcord does record it TODAY! As long as the standards that are set in the i3 specification revolving around SIPREC are being followed by the CPE, Revcord has you covered.

Revcord provides this service at the position level and each position is treated as a TT9-1-1 channel.

Trunked Radio Recording

The Recording of a Trunked Radio ID System can be summed up in one sentence. Trunked Radio ID Integration is the process of synchronizing Audio Traffic (radio traffic) and Radio Control Data. It is that simple. The tricky part is receiving that data. Outlined below are the four industry standards on receiving this Data/Traffic along with Revcord's solution.

The Motorola Radio ID Integration Solution

Motorola uses an AIS server which acts as a gateway for the Control Data and a router for the Audio Traffic. The Control Data is sent to the recorder via network TCP and the Audio Data is sent via network UDP. Revcord has a program that resides on the AIS server to perform this functionality and has the Revcord Data Synchronization Program residing on the Recorder. Revcord has multiple reference sites.

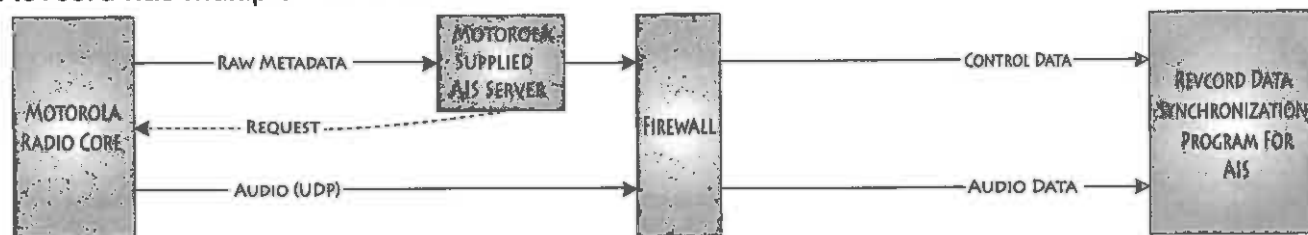

The Harris Radio ID Integration Solution

Harris uses its VIDA switch which is effectively a network switch to provide for the Control Data and the Audio Traffic. The Control Data and the Audio Traffic is sent via network UDP. Revcord is an approved vendor for the Harris Radio ID Integration and has reference sites.

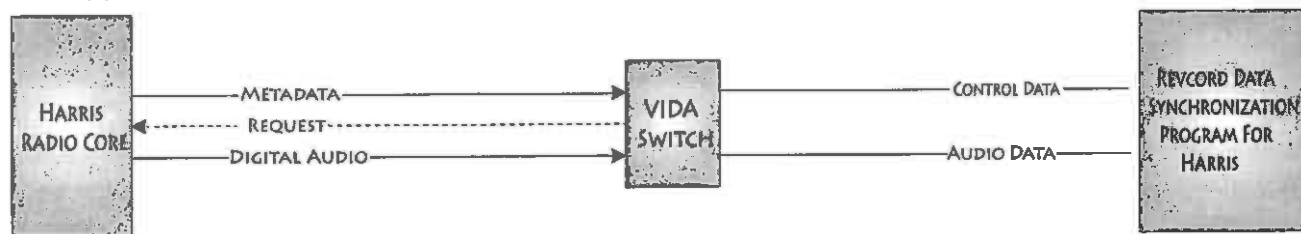

Revcord Software Overview

The Open APCO Standard Radio ID Integration Solution – ISSI/CSSI

This open standard is provided as an alternative by both Motorola and Harris. It is also the standard for many other radio companies such as EF Johnson. However, both Motorola and Harris do not provide full functionality to the open standard. The Control Data and Audio Traffic is sent via UDP through a network switch on the Radio Network.

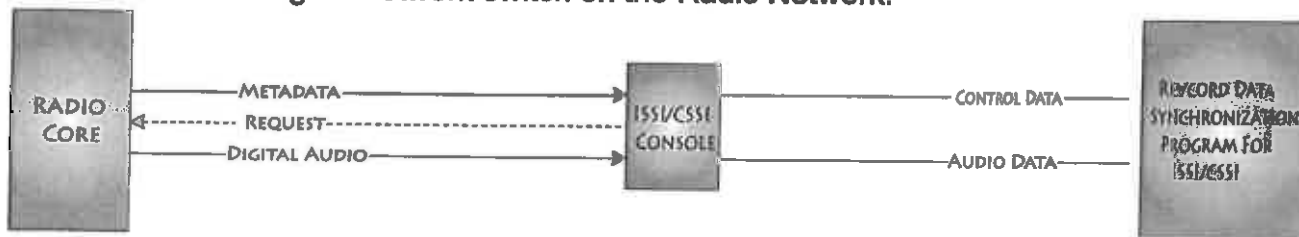

The Third Party Console Radio ID Integration Solution

Most third party console manufacturers that tie into the various Cores of Motorola, Harris, EF Johnson and others that have performed the integration necessary to provide for the Radio ID information. Revcord has integrations with the most compatible third party console manufacturers to display Radio IDs.

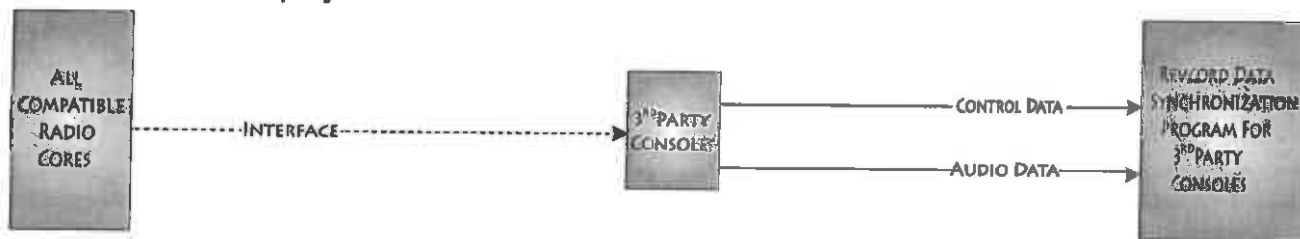

The Revcord Radio ID Integration Solution

Revcord relies on Control Data, either through a tower and a Control Channel Receiver, or through an ATIA data feed for when multiple sites are involved. Revcord is dependent on having analog channel audio feeds. With the advent of the MCC7500, this cost HAS come way down compared to buying a radio resource for each analog channel. This is by far the most economical solution in the marketplace today.

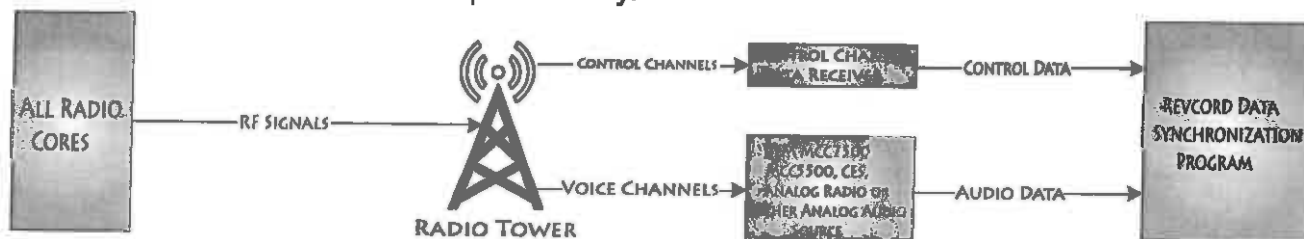

Methods of Revcord's Radio ID Integration

- Method 1 - Talk group recording
- Install a radio with desired talk group selected.
- Control channel receiver provides associated metadata.
- Independent of protocol (P25 Phase I/Phase II, SmartNet/SmartZone, EDACS)
- Radio also provides the needed encryption key
- Method 2 - Frequency recording
- Currently only available in a P25 Phase I environment.
- Control channel receiver and radios are used to monitor the control channel and the frequencies.
- Control channel receiver provides all of the metadata.
- Parsing calls by talk group ID, radio ID, or dispatch console ID available.
- Radios provide the audio from the group call based on the frequency used.

Revcord Software Overview

Audio Sources

The use of base stations, mobile, or portable radios provide the required audio directly from the tower that the field radios and consoles are using. In addition, many consoles can provide alternatives. The MCC7500 provides for excellent options. The Voice Processing Module for the dispatch console has a logging recorder port and eight speaker ports on the back. The speaker ports are provided by Motorola to send audio to other locations in a dispatch center for talk group monitoring purposes. These ports are talk group assignable and provide an analog audio feed of selected and unselected talk groups.

Advantages Of The Revcord Trunked Radio ID Recording Solution

- Avoid the purchase the AIS hardware or other wire line hardware, a separate computer in addition to the recorder.
- Avoid the costly Motorola imposed AIS license fee or other manufacturer connection fees.
- Avoid the high yearly maintenance costs charged by Motorola, other trunked radio manufacturers, and the recorder competition.
- Avoid the hassle of coordinating with outside agencies.
- Avoid the constant upgrade cycle.
- Gain a simple to understand solution that doesn't need a high priced technician to maintain.
- Gain integration between your radio recordings, your 911 phone recordings and your admin phone line recordings. One recorder does it all.
- Supports P25 (any vendor) phase 1 and phase 2 (Talkgroup Recording Only). Also supports Motorola 3600 baud trunking systems.
- Supports any configuration of trunking, system including standalone sites, cores, SmartZone and simulcast.
- Supports secure (encrypted) talkgroups.
- Supports the recording of private calls.
- Records every talkgroup call for every talkgroup using the trunking site. New talkgroups added to the trunking site are automatically recorded at no additional cost.
- Guaranteed to record all calls for monitored talkgroups. Recorder records EXACTLY what radio users hear. Single site and multi-site implementations.
- Provides local control of the recordings since all equipment is owned by you and is in your building which means no dependency or connections to outside agencies and no fees/ hassles.
- No networking bandwidth, leased line charges or agency coordination issues.

The Revcord solution records exactly what the end radio user hears . The Revcord solution is based on actual radio receivers. The recorded audio captures exactly what field radios hear including any noise, static or sounds introduced by the radio system's repeater or hardware backbone. The AIS solution records audio taken internally within the trunking system and does not represent the audio broadcast.

Revcord uses control channel data to gather radio and talkgroup IDs. The control channel is the most standardized and stable aspect of the entire trunking system. Simply upgrade the radio like every other radio in the system, and the recording will work. Revcord uses commercial readily available equipment to provide the control channel's raw data. The real concern is for the AIS technology. When you buy an AIS integration, you are locking into an upgrade cycle. Every time Motorola releases a version upgrade or patch, there can be an upgrade to the recording system.

Revcord Software Overview

Conventional Radio ID Integration

Radio IDs is done through voice channel signaling versus a control channel for talk groups. There are two types which are MDC1200 and FleetSync. MDC1200 is used by Motorola and FleetSync supports other manufacturers like Kenwood. Traditionally this voice signaling has been decoded by hardware like a Cimarron Decoder. Revcord now provides this as a software based option which will provide the Radio IDs and the ability to create Aliases.

Other Feature Sets

Bookmarking and Call Commenting

Bookmarking is a feature which enables users to add, edit, and view bookmarks of a call at a specific point in the call. While live monitoring or playing back a call, you can add bookmarks by simply clicking the bookmark button. This places a bookmark at that point of the call. You can also use the bookmark by right clicking on the central slider knob. A popup will appear, enter bookmark text, Click on Bookmark button from popup to save the bookmark. Bookmark text cannot be more than 300 characters.

In addition, Revcord has adjustable columns which you can customize. You can also add your comments against single or multiple calls on the "Search Page". We have provided seven different columns with editable feature. These columns are Call Comments, Custom Info 1, Custom Info 2, Custom Info 3, Custom Info 4, Custom Info 5, Caller ID/Dialed Number and Call Tags. You can insert data into these fields and this data will be updated on the Search Page.

Commercial Off The Shelf (COTS) Hardware and Software

Revcord's hardware platform is exclusively Tier 1 hardware, including the voice capture cards. Therefore, in the unlikely event that Revcord were not in business in the future any and all hardware replacement can be easily obtained on the open market. The standard hardware warranty for all Revcord systems is a full three years for hardware. Revcord uses only "shrink wrap" Microsoft standard software for both the operating system and the SQL Express Server database. Revcord model series CYA is an economical tower based recording system with a single power supply and a single 1TB hard drive. The MCS series is a high reliability rack mountable system with dual hot swap power supplies and dual hot swap RAID 1 1TB hard drives. (RAID 5 or 6 is also available with larger hard drives.

Multimedia Recording Inputs – Analog, Digital, VoIP and Multiple Screens

Multimedia recording for NG9-1-1 and similar environments is provided in accordance with NENA document 08-003. All types of inputs such as video, text, telematics and other media can be recorded and replayed in synchronized format. All multimedia input can be recorded as RTP packets in a SIP signaling environment.

All Revcord voice recorders are capable of recording analog, any digital TDM and any unencrypted VoIP in a single system. Also, one or multiple screens per workstation can be synchronously recorded with the voice traffic. VoIP calls can be recorded in either a passive

Revcord Software Overview

mode (port mirroring) or in an active, SIP Invite mode. For both analog and digital TDM voice capture cards. These cards are capable of supporting 8, 16 or 24 channels per PCI/PCIe slot. All VoIP (H.323, SIP or Skinny) recording is a software only solution. Each recorder platform can accommodate up to 168 channels of analog and/or digital TDM recording. In addition to any analog or digital TDM channels, a Revcord recording platform can also provide up to an additional 300 "channels" of VoIP recording. VoIP recording channels can be added to any existing analog and/or digital TDM Revcord recorder by a simple software download. Text in the form of SMS or MMS can be recorded depending upon the telephone carrier.

Bookmarks Save With Playlists

Bookmarks on calls will be saved when creating playlists.

DSF Player

A light client player that has the ability to access and play DSF files from backed up files with an upgraded look and feel.

Simplification of Multiple Revconfig IP Addresses

In the Revconfig, there is now only one location to put the Server IP address.

New Integrations

After a successful Motorola, AIS integration for the New Mexico State Police, Revcord is just finishing up the Harris Symphony/Maestro integration for Coral Gables. In addition, Revcord has completed full integrations for Avtec and Telex.

Save & Load User Searches

Cache search settings are set in the Browser for same session. In addition, Users can save search settings for later use.

Saving And Exporting A File

Saving and exporting files by email or other means is simple. Simply choose the file(s) you want to save and the process is automated.

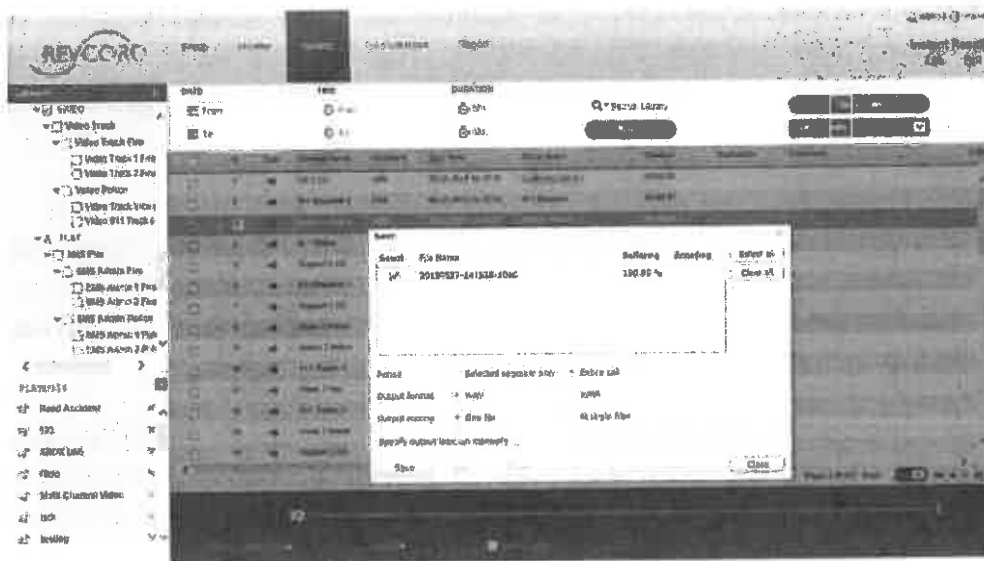

Revcord Software Overview

Saving And Exporting A Playlist

Revcord provides two ways to save a Playlist. You can save it in the List View Mode or the Time Line Mode. The procedure is very similar to saving audio files. You simply click on Save Tracks in the mode you are in and it creates an exact copy that is secured using watermarking. It is a single Zip file and when unzipped, it creates an HTML executable file which can automatically be emailed with a click of a button. When executed, it uses the default browser of the User and displays a fully functional identical Playlist just as if it were connected to the recorder.

SIP Invite Improvements

Auto Correct SIP Invite for all caps issue for entering MAC address.

Spec Sheet

Revcord Spec Sheet

Hardware & Configuration

MCS Model

Rack Mountable, 4U Mission Critical Server



This model is intended for applications in which Multimedia Recording is critical and where even the remote possibility of one call being missed could have unacceptable consequences.

The model MCS features dual hot swappable 1 TB RAID Edition hard drives with Raid 1 (mirrored recording on the hard drives) and dual hot swappable power supplies for added redundancy in a Rack Mount Chassis.

Qty	Description
(1)	Black 4u Compact Rackmount Chassis
(2)	MobileRack
(1)	Redundent Power Supply
(2)	DDR3 (8GB Total)
(2)	WD 1TB HDD RE SATA 7200RPM 16MB (Ships with RAID1)
(1)	Intel I5-4460 3.4GHz
(1)	DVDRW
(1)	USB Keyboard & Mouse
(1)	Windows OS - Windows 7 Pro 64BIT (Optional Windows Server 2012)
(2)	Rack Rails for I-star rack

- Up To 168 Combined Analog And Digital Channels And 300 VoIP
- Up to 300,000 Hours of On-line Recording Standard
- Commercial Off The Shelf (COTS) Hardware and Software
- Archiving with 1 TB Hard Drive

Qty Description

(1)	Antec Tower and Power Supply
(2)	DDR3 (8GB Total)
(1)	WD 1TB HDD RAID Edition SATA 7200RPM 16MB (Ships with RAID1)
(1)	Intel I5-4460 3.4GHz
(1)	DVDRW
(1)	USB Keyboard & Mouse
(1)	Windows OS - Windows 7 Pro 64BIT (Optional Windows Server 2012)

The model MCT was specifically designed and priced where price is of primary consideration and redundancy is not a critical requirement.

The model MCT features a tower chassis, 1 TB RAID Edition hard drives with Raid 1 (mirrored recording on the hard drives) and the option of backup to a USB hard drive or Network Attached Storage (NAS).



MCT Model

Mission Critical Tower

- Up To 168 Combined Analog And Digital Channels And 300 VoIP
- Up to 300,000 Hours of On-line Recording Standard
- Commercial Off The Shelf (COTS) Hardware and Software
- Archiving with 1 TB Hard Drive

10190 Katy Freeway Suite #501
Houston, TX 77043
www.revcord.com



1-866-559-2188
Local 281-404-7040
Fax 281-404-5323

Version 2: 4-4-2016

Revcord Spec Sheet

Software Overview

Top Features

- Call Redaction
- Encryption – AES 256 With SHA Watermarking
- Geo-Tagging
- HTML5 Compliant Works on All Browsers
- Incident Recreation
- Inquire Plugin For Incidents, Interviews, Investigations, and Inspections
- Instant Recall Lite and Install Recall Full
- Live Monitoring
- Mobile Call Recording – Android Only
- Monitor “Dashboard” and Multi-Channel Live Monitoring
- Multimedia Recording Inputs – Analog, Digital, VoIP,
- Video, Text, and Multiple Screens
- Multi-tenant Operations
- Next Generation 9-1-1 (NG9-1-1) i3 Compliant
- Quality Monitoring and Call Taker Evaluation
- Remote Monitoring Service Via RevShield
- Statistical Analysis and Reporting in Excel or Graph Format
- RevAgent – Multiple Screen Capture, Record on Demand, and Free Seating
- RevStream Cloud-Based Services
- Saving and Exporting Multimedia Files and Playlists
- SIP Invite - Built In Bridge
- Trunked Radio Recording and ID Integration - All Manufacturers
- Virtual Universal View For Multiple Sites

Other Features

- Assignable Search, Save, and Monitor Restrictions
- Advanced Search by ANI/ALI, Caller ID, Dialed Number, or Call Tagging
- Bookmarking and Call Commenting
- Bookmarks Save With Playlists
- Standard Search by Channel, Date, and Time
- Agent login & Evaluation Feedback
- Agents Drop-Down List On Evaluation Screen
- Edit/Delete Published QA Forms
- Email Evaluations
- ANI/ALI
- Combine Analog, Digital, and VoIP in Same Chassis
- Concurrent or Fixed VoIP Channel Option
- Auto Burn Multiple Recording in .WAV or .WMA to CD
- Backup Management Software
- Comprehensive Reports Package
- Reports and Statistics
- Email and save in .WAV, .WMA, .HTML, or Encrypted Format
- Evaluate Screens
- Watch Screen Recording Live
- Revcord Media Player with Encrypted Recordings
- WebUI Logging Module

VoIP Upgrade Policy

Revcord VoIP Upgrade Policy

In the current economic environment we understand that as desirable as a VoIP telephone system may be, not all agencies can upgrade to VoIP in the current budget year. However, those same agencies may need to replace their voice logging recorder quickly. If a new recorder is purchased now costs to upgrade to VoIP later may be quite expensive – except with Rvcord.

Rvcord solves that problem. Simply buy your new Rvcord analog, digital or analog + digital recorder now and you can trade in those recording boards for full functioning VoIP software at NO COST if done within one year of the initial installation. Depending upon your IP PBX and VoIP phones there may be a small configuration charge for set up. This could easily be a savings of thousands of dollars. Upgrade VoIP trade-ins are limited to full voice board quantities. For example, a 96 channel analog recorder has four (4) each twenty-four (24) channel boards so, upgrade trade-ins to VoIP software are limited to 24 channel increments.

But wait, our offer is even better. For year one after initial installation VoIP upgrades are free and in year two VoIP upgrades will be provided at 50% of the then current price.

Rvcord is committed to making your acquisition of a new multimedia recorder simple, full featured, inexpensive and “future proof”. In the not too distant future Next Generation 9-1-1 will be with us and you won’t need to buy yet another recorder. Rvcord has been an active participant in the NENA NG9-1-1 development program for several years. We have completed all the official testing so that when text, video, telematics etc. must be recorded it will be just a matter of a software download to be fully compliant.

10190 Katy Freeway Suite #501
Houston, TX 77043
www.revcord.com



1-866-559-2188
Local 281-404-7040
Fax 281-404-5323
Version 2: 4-4-2016

RevShield Program

RevShield Program

Summary

RevShield provides for software assurance and technical support. The main objective of software assurance is to ensure that the processes, procedures, and products used to produce and sustain the software conform to all requirements and standards specified. Software Assurance provides for Patches and Upgrades. Without RevShield, there is an hourly charge for support.

All Revcord products come with a limited five year hardware warranty and a limited one year software warranty. All systems at the time of purchase include the standard RevShield RSSTD. Please see the Revcord Warranty Statement and the RevShield Service Level Agreement for additional information.

Software Assurance Terms

Provided below is a glossary of terms and descriptions to better understand the products and processes associated with Software Assurance.

Upgrades

"Upgrades" are version to version upgrades such as Version 9 to Version 10. Unless you are under the RevElite program, there is a charge of 20% of the MSRP to go from version to version.

Patches

A "Patch" is a piece of software designed to update the Revcord software or its supporting data, to provide Hotfixes, new features and improvements, and to address errors, failures, or faults introduced by third parties/external factors. This is included in your RevShield software assurance program but not available if RevShield is inactive. Performance issues caused by outside third parties could result in the upgrade to a newer version of software. Version to Version upgrades have a fee which is outlined on the Revcord Price List if Revcord.

Software Hotfix

A "Hotfix" addresses an error, flaw, failure, or fault in the Revcord software that causes it to produce an unexpected result or to behave in unintended ways. Software Hotfixes do not address errors, failures, or faults introduced by third parties/external factors.

Revshield Packages

RSSTD: This is the base package that is included in your first year of purchase. It provides for 9 to 5 Help Desk, In Version Upgrades, and Patches for all systems. The MSRP is 6% of the retail price of the product being purchased.

RSPLUS: This package provides for 24/7 Help Desk, Logmein Monitoring, , In Version Upgrades, and Patches for all systems which will be subject to the RevShield program terms and conditions. The MSRP is 9% of the retail price of the product being purchased.

RevShield Program

RSPLUS-24: In addition to the RSPLUS, the Dealer will receive onsite service with a next day response for all systems which will be subject to the RevShield program terms and conditions. The MSRP is 12% of the retail price of the product being purchased.

RSPLUS-4: In addition to the RSPLUS, the Dealer will receive onsite service with a four hour response for all systems which will be subject to the RevShield program terms and conditions. The MSRP is 15% of the retail price of the product being purchased.

Subject to the terms and conditions of the RevShield Service Level Agreement, Revcord provides for Training, Use of the Software, Patch Implementation, Onsite Support Dispatch, and Configuration.

Technical Support

If you are not on RevShield, there is an hourly charge of \$250 per hour. With RevShield, Technical Support and the items covered are in the RevShield Service Level Agreement. In general RevShield covers the following items: Operational Questions, Trouble Shooting, and Onsite Support Dispatch. Regarding the timing of support requests they are broken down into three categories:

- **Level 1** – The impact of the reported deficiency is such that the recorder is not recording. Revcord will commence work on resolving the deficiency within one (1) hour of notification until an acceptable resolution is achieved.
- **Level 2** – Important features of the Software are unavailable, but an alternative solution is available or non-essential features of the Software are unavailable with no alternative solution. The customer impact, regardless of product usage, is loss of operational functionality or implementation resources. Revcord will commence work on resolving the deficiency within one (1) business day of notification and will engage staff during business hours until an acceptable resolution is achieved.
- **Level 3** – Customer submits a Software information request, software enhancement or documentation clarification which has no operational impact. The implementation or use of the Software by the Customer is continuing and there is no negative impact on productivity. Revcord will provide an initial response regarding the request within one (1) business week.

RevShield Service Level Agreement

RevShield Service Level Agreement

Terms and Conditions

- 1. General.** Under this Service Agreement Stonehenge Properties, Ltd. dba Revcord ("Revcord") Revcord will repair or replace, at Revcord's option, products that have failed. Excluded from this agreement are failures due to acts of God or negligent or intentional actions of the user. These general terms and conditions shall apply to all service provided to Customer by Revcord. This Service Level Agreement is in addition to the standard Revcord Warranty. Any provisions that conflict with the Revcord Warranty shall supersede those terms and conditions.
- 2. Service Provider.** Revcord may appoint third parties to perform service under this Service Agreement. All references herein to Revcord shall be deemed to include such service providers.
- 3. Term.** The term of this Service Agreement shall commence on the date below and continue for one year.
- 4. Taxes.** Service fees are exclusive of all state / provincial and local sales, use, excise, privilege and similar taxes. Such taxes shall be paid by Customer, unless a valid exemption certificate is furnished by Customer.
- 5. Remedial Service.** In the event of product failure under this agreement, Revcord will, at its option, repair the defective product by means of telephone support for all non onsite support plans. For on-site support plans, Revcord will, at its option, repair the defective product by means of telephone support or on-site service at no charge for parts and labor or replace the product with a comparable product. To obtain service under this Service Agreement, the Customer must first contact Revcord Telephone Support personnel or that of its authorized service representative. Telephone Support personnel will work to resolve issues professionally and quickly, however the Customer must reasonably assist Revcord or its authorized representative.
- 6. Product Location.** Products need to be located where they are easily accessible for service such that the environment does not affect the serviceability of the product.
- 7. Obligations of Customer and Dealers.** Customer and Dealer shall permit Revcord access to the products whenever on-site service is required. Customer and Dealer shall ensure that the user cooperates with Revcord to the extent necessary to permit service to be performed efficiently and without interruption. Customer and Dealer shall permit Revcord to use any Customer and Dealer equipment or facilities that Revcord reasonably deems necessary for the performance of service. Customer shall be responsible for the procurement, installation and maintenance of all non-Revcord communication media including, but not limited to, Customer's and Dealer's computer networks. Charges for the use of such media and equipment in connection with the performance of service shall be borne by Customer and/or Dealer. Site is responsible for all Windows Updates. Not updating Windows can cause the system to malfunction and stop recording. It should be done manually. If a product under service fails

RevShield Service Level Agreement

through operation in a site not meeting normal operating environmental specifications, Revcord may refuse to provide service until the site meets such specifications. Dealers are required to perform Tier 1 Support and Revcord will not interact with the End User except for Level 2 service or higher.

8. Dedicated Use of Revcord Equipment. Customer acknowledges that installing or running any additional software on the Revcord equipment, or changing any settings on the Revcord equipment, may damage the Revcord equipment. Customer agrees not to do so for the period of the Service Contract, other than the installation and maintenance of virus protection software in good commercial practice.

9. Replacement Items. In the maintenance of any product, Revcord may use new, remanufactured, or refurbished parts, assemblies, or products. All defective parts, assemblies, or products, become the property of Revcord. Revcord may require the return of these parts, assemblies, or products to a designated Revcord Depot or the Revcord representative from which the part, assembly, or product was originally purchased. Returns and claims will be handled according to the current Revcord procedure.

10. Telephone Support and Remote Diagnosis. To ensure that the product is repaired as quickly and efficiently as possible, Revcord recommends that Customer first utilize support materials shipped with the product, product diagnostics, information contained on the Revcord's product support website, and email support. If unsuccessful, Customer will provide appropriate assistance to Telephone Support personnel to resolve issues. Revcord shall have the right of remote access to the product via RevWatch or a comparable service. If controllable access is not given, an hourly charge may incur.

11. Limitations. This Service Agreement shall not apply to any defect, failure, or damage caused by improper use, or inadequate or improper maintenance and care, or if outside factors are the cause of a problem or defect. Revcord shall not be obligated under this Service Agreement to:

1. outside conditions which cause the recorder to operate improperly including but not limited to poor line quality, poor radio quality, changing of VoIP protocols, and any other items which could affect the recorder,
2. repair damage resulting from attempts by personnel other than Revcord representatives,
3. repair modification or damage resulting from attempts by personnel other than Revcord representatives to the Revcord SQL database or configuration,
4. repair modification or damage resulting from attempts by personnel other than Revcord representatives to the punch down blocks, passive taps, Amphenol cables or any other Revcord hardware,
5. customer or third party acts to install, repair or service the product unless directed by a Revcord representative,

RevShield Service Level Agreement

6. repair damage, malfunction, or degradation of performance resulting from improper use or connection to incompatible equipment or memory,
7. repair an item that has been modified or integrated with other products when the effect of such modification or integration increases the time or difficulty of servicing the product or degrades performance or reliability,
8. repair damage, malfunction, or degradation of performance resulting from use of the product in an environment not meeting normal operating environment specifications,
9. repair damage, malfunction, or degradation of performance resulting from acts of God or nature, acts of terrorism, explosion, flood, fire, war and riots, support software not supplied by Revcord.

Any service identified in the preceding section and provided by Revcord at Customer's request shall be invoiced to Customer at Revcord's then current rates for parts, labor and travel.

12. Enhancements or Upgrades. Software or firmware enhancements/upgrades shall be provided by Revcord under this Service Agreement. In version upgrades are provided at no charge. Version to Version upgrades have a fee which is outlined on the Revcord Price List.

13. Software and Firmware Updates. Updates may be required to correct performance problems with the Revcord software and will be provided under this Service Agreement where deemed applicable by Revcord for no charge. Performance issues caused by outside third parties could result in the upgrade to a newer version of software. Version to Version upgrades have a fee which is outlined on the Revcord Price List.

14. RevShield Help Desk Support. Help Desk Support covers the following items:

- Operational Questions
- Trouble Shooting
- Onsite Support Dispatch

15. RevShield Plan Offerings. Revcord offers four types of plans as outlined below:

1. **RSSTD:** This is the base package and provides for 9 to 5 Help Desk, In Version Upgrades, and Updates as defined by Section 12 and 13.
2. **RSPLUS:** This package provides for 24/7 Help Desk, Upgrades, and Updates as defined by Section 12 and 13. In addition, for those that allow Logmein, Revcord will monitor the system through Logmein Alerts.
3. **RSPLUS-24:** In addition to the RSPLUS, this package will provide for onsite service with a next day response.
4. **RSPLUS-4:** In addition to the RSPLUS, this package will provide for onsite service with a four response.

RevShield Service Level Agreement

16. Request for Service And Severity Levels For Service. Any customer requesting service that is considered to be Level 1 to Level 3 is required to have a service ticket number. Below are the different classifications of service requests and Revcord's associated responsibility:

Level 1 – Critical Business Impact

The impact of the reported deficiency is such that the recorder is not recording. Revcord will commence work on resolving the deficiency within one (1) hour of notification until an acceptable resolution is achieved. In addition, for RevShield plans that have onsite service, a technician will be dispatched should it be deemed there is a hardware issue.

Level 2 – Moderate Business Impact

Important features of the Software are unavailable, but an alternative solution is available or non-essential features of the Software are unavailable with no alternative solution. The customer impact, regardless of product usage, is loss of operational functionality or implementation resources. Revcord will commence work on resolving the deficiency within one (1) business day of notification and will engage staff during business hours until an acceptable resolution is achieved.

Level 3 – Minimal Business Impact

Customer submits a Software information request, software enhancement or documentation clarification which has no operational impact. The implementation or use of the Software by the Customer is continuing and there is no negative impact on productivity. Revcord will provide an initial response regarding the request within one (1) business week.

17. Hours of Operation. Help Desk Support is available 24/7. However, after hours support which would be considered weekends, holidays, and 5pm to 9am CST is only available for Level 1 severity levels. Any calls made to after hours for Level 2 to Level 3 support is subject to Revcord's hourly rate as outlined in the Revcord Price List.

18. Confidential Information, PCI Compliance, and HIPPA Compliance. "Discloser" and "Recipient" apply to both Parties depending on their role, whether as the discloser or the recipient of Confidential Information. "Confidential Information" means the terms of this Agreement; a Party's proprietary or confidential information, intellectual property, trade secrets, know-how, software, technology, specifications, and non-public business or financial information; a Party's member, customer and employee data, Patient Data (as defined below), personally identifiable information ("PII"), and payment card industry information ("PCI"); any written materials marked as confidential; and any other information of a Party, including visual or oral information, which reasonably should be understood to be confidential. Confidential Information also means any third party's information provided to a Party under obligation of confidentiality.

RevShield Service Level Agreement

"Patient Data" means any "protected health information" under HIPAA, including, without limitation, any data or information concerning a patient's treatment, procedure, medicine, drugs, diagnosis, therapy, surgery, outcome, history, genetics, disclosure, behavior, name, address, or other identifying information of, or applicable to, any patient.

Use and Protection: Recipient may use Discloser's Confidential Information solely for the purposes of this Agreement and as permitted or required under this Agreement. Recipient will safeguard Discloser's Confidential Information by doing the following:

- not disclosing Discloser's Confidential Information, or permitting anyone else to disclose it, except to those employees, credentialed physicians, advanced practice clinicians, affiliates, accountants, attorneys, and consultants of Recipient who have a need to know and are required to keep it confidential;
- keeping confidential all of Discloser's Confidential Information;
- maintaining Discloser's Confidential Information in a safe and secure place;
- exercising the same degree of care to safeguard Discloser's Confidential Information as it would in protecting its own, but in no event less than reasonable care; and
- returning or destroying all documents, copies, notes, or other materials containing any of Discloser's Confidential Information upon Discloser's request.

Exceptions to Obligations: The exceptions in this Section do not apply to Patient Data, PII, or PCI, which remain subject to the confidentiality obligations of this Agreement. Recipient is not subject to the confidentiality obligations of this Agreement regarding Confidential Information that Recipient can prove meets any of the following criteria: (a) is or becomes publicly available without breach of this Agreement, but only from the date that it becomes publicly available; (b) was rightfully in Recipient's possession without an obligation of confidentiality owed to Discloser before Recipient received it from Discloser; (c) was disclosed to Recipient by a third party without obligation of confidentiality owed to Discloser; or (d) is independently developed by Recipient without using any of the Confidential Information.

Patient Data, PII, and PCI: If Customer permits Revcord to create, use, disclose, access, de-identify, aggregate, maintain, or transmit any of Customer's Patient Data, PII, or PCI under this Agreement, Revcord must first sign, and require its contractors to sign, an approved business associate agreement ("BAA") and data security agreement ("DSA"). The BAA and DSA are independent, stand-alone agreements and survive any termination of this Agreement. This Agreement does not amend, alter, or limit the BAA or DSA. With respect to Patient Data, PII, and PCI, if a conflict arises between this Agreement and the BAA or DSA, the BAA or DSA, as applicable, governs. Unless specifically permitted under the BAA or the DSA, Revcord may not create, use, disclose, access, de-identify, aggregate, maintain, or transmit any of Customer's Patient Data, PII, or PCI. If Revcord fails to comply with the previous sentence or discovers Customer's Patient Data, PII, or PCI, then Revcord will (a) notify Customer immediately in writing, and (b) follow Customer's instructions for returning or destroying that Patient Data, PII, or PCI.

RevShield Service Level Agreement

Judicial Order: If a judicial or governmental request or order seeks Confidential Information, Recipient may disclose that Confidential Information as requested or ordered. But, if permitted by applicable law, Recipient must notify Discloser before disclosing the Confidential Information and cooperate with Discloser's reasonable requests in seeking a protective order or limiting the effect of that disclosure.

19. Limited Liability. Customer expressly agrees that use of Revcord hardware and software is at Customer's sole risk. Neither Revcord, its employees, affiliates, agents, third party information providers, merchants, licensors, or the like, warrant that the Revcord service will not be interrupted or error free; nor do they make any warranty as to the results that may be obtained from the use of Revcord. Under no circumstances, including negligence, shall Revcord, its officers, agents or anyone else involved in creating, producing, or distributing Revcord be liable for any direct, indirect, incidental, special or consequential damages that result from the use of or inability to use Revcord; or that results from mistakes, omissions, interruptions, deletion of files, errors, defects, delays in operation, or transmission or any failure of performance, whether or not limited to acts of God or Nature, communication failure, theft, destruction or unauthorized access to records, programs or services. Notwithstanding the above, Customer's exclusive remedies for all damages, losses and causes of actions whether in agreement, tort including negligence or otherwise, shall not exceed the aggregate dollar amount which Customer paid during the term of this Agreement.

20. Indemnification. Customer agrees to indemnify Revcord against liability for any and all installations and use of the Revcord product by Customer. Customer agrees that it shall defend, indemnify, save and hold Revcord harmless from any and all demands, liabilities, losses, costs and claims, including reasonable attorneys' fees, asserted against Revcord, its agents, its customers, servants, officers, and employees, that may arise or result from any service provided or performed or agreed to be performed or any product sold by Customer, its agents, employees, or assigns. Customer agrees to defend, indemnify and hold harmless Revcord against liabilities arising out of (i) any injury to person or property caused by any products sold or otherwise distributed by Customer in connection with the use of Revcord; (ii) any material supplied by Customer infringing or allegedly infringing on the proprietary rights of a third party; (iii) copyright infringement and (iv) any defective product which Customer sold in conjunction with using Revcord.

21. Waiver. Failure of either party to enforce any provision of this Service Agreement shall not be deemed a waiver of future enforcement of that or any other provision.

RevShield Service Level Agreement

22. Assignment. Customer may not assign or otherwise transfer its rights or obligations under this Service Agreement without the prior written consent of Revcord.

23. Governing Law. For products located in the United States this Service Agreement shall be governed by the laws of the State of Texas.

24. Notices. All notices shall be given in writing and shall be effective upon receipt. Notices to Customer shall be sent to the Customer's address on file with Revcord. Notice to Revcord shall be sent to:

Revcord
10190 Katy Freeway
Suite 501
Houston, Texas 77043

25. Entire Service Agreement. This document provided by Revcord shall contain the entire Service Agreement between the parties. This Service Agreement may not be modified except by written amendment signed by an authorized representative of each party. During the term of this agreement, the Customer may delete and add Designated Contacts by sending notification in writing on Customer's letter head and addressed to Revcord's Operations Manager. We may rely on such notice to make the change.

26. Software Sunset Policy. Revcord ensures you always access the newest technology when you are investing in Revcord solutions. As Revcord continues to innovate and introduce new product solutions, older products that have reached the end of the product lifecycle will no longer be available for sale. In addition, only the most recent version of software is available for sale. Current software can be upgraded or patched but new sales are for current versioned software only. Revcord will provide customer support services including phone support, email support and repairs up to three years including software patches. Between three and five years, Revcord will continue additional customer support services including phone support, email support and Hot Fixes but Patches will not be available. These products will require full version software upgrades. At the end of five years, products reach their end of life. Revcord will continue to provide minimal technical support for an additional two years after the End of Life but cannot guarantee any solutions or feature sets will be available. Revcord will

RevShield Service Level Agreement

discontinue products and product support according to the End Of Life Product Schedule listed further on this page. Please refer to the Schedule of discontinued products and product support table listed below.

End Of Life Product Schedule		
<i>Version</i>	<i>Patch Eligibility</i>	<i>End Of Life</i>
3.0	12/31/2007	12/31/2009
4.0	12/31/2008	12/31/2010
5.0	12/31/2009	12/31/2011
6.0	12/31/2010	12/31/2012
7.0	12/31/2012	12/31/2014
7.1	12/31/2013	12/31/2015
8.0	12/31/2014	12/31/2016
8.1	12/31/2015	12/31/2017
8.2	12/31/2015	12/31/2017
9.0	12/31/2016	12/31/2018
9.1	12/31/2016	12/31/2018
9.2	12/31/2017	12/31/2019
9.3	12/31/2017	12/31/2019
9.4	6/30/2018	6/30/2020
10.0	2/1/2019	2/1/2021

27. Designated Onsite Contacts

Designated Onsite Contacts, full names followed by telephone number and e-mail address.

Contact 1

Name: _____

Telephone #: _____

E-mail Address: _____

Contact 2

Name: _____

Telephone #: _____

E-mail Address: _____

RevShield Service Level Agreement

28. RevShield Plan and Price. The following plan shall be in effect for 1 year from the date of this agreement:

Plan Type: _____
Serial Number: _____
Term Start Date: _____
End Start Date: _____

29. Customer Acknowledgement.

Site Name: _____
Authorized Representative: _____
Title: _____
Signature: _____

RevShield Software Suite

RevShield Software Suite

What is RevGuard?

RevGuard is an integrated hardware and software monitoring application that has been hand-crafted to monitor your Revcord Voice Logging System components. RevGuard works hand-in-hand with RevWatch. RevWatch is a cloud-based application that manages the alerts and notifications pertaining to the health and status of all systems running RevGuard.

What is RevWatch?

RevWatch is sent signaling that acts as a heartbeat and a report. There is a dashboard that shows a system summary. RevWatch also receives all of the alerts from RevGuard. Please note that RevWatch can also work on closed networks that have no internet ability.

Will IT approve of this solution as secure?

YES! At Revcord, we know security is a leading factor in many IT Departments' decision making. RevGuard was designed and built with keeping Security as a priority. RevGuard does not require any listener sockets or TCP/UDP ports to be created. That means RevGuard is "closed off" to the outside world. In the event of a trigger or alert, an outgoing encrypted signal will be sent via SSL to RevWatch via a User defined outbound port only for base situations. For remote access and support, there are also security protocols in place.

How does RevGuard work?

RevGuard uses its built-in monitoring system to detect problems before they happen, and to alert on system-critical issues that may have gone unnoticed by the Network Administrator. RevGuard uses fully configurable triggers. A trigger will initiate an alert to RevWatch.

What does RevGuard monitor?

RevGuard alert triggers are also configured locally and are fully customizable. Several aspects can be configured for monitoring: Hard Disk Status, Hard Disk Storage Space, CPU usage, Memory usage, Revcord software processes or stops/crashes, exceptions created by Revcord Processes, Revcord channel activity, and file deletion.

What types of notifications/alerts does RevGuard offer?

RevGuard notifications/alerts are configured locally, and are fully customizable. There are many different ways in which an alert can be manifested: Email notifications, automatic ticket creation in the Revcord Ticketing System, Remote Assistance Requests, or Taskbar Icon/Balloon messages.

Are all of my recorders monitored by RevWatch?

The RevWatch monitoring system benefits all customers whose Revcord Voice Logging Systems are currently protected by RevShield packages: RSSTD, RSPLUS, RSPLUS-24, and RSPLUS-4.

10190 Katy Freeway Suite #501
Houston, TX 77043
www.revcord.com



1-866-559-2188
Local 281-404-7040
Fax 281-404-5323
Version 2: 4-4-2016

RevShield Software Suite

RevGuard – How does Remote Support work?

Revcord provides for two modes of remote capability again keeping in mind security as our primary priority: On Demand Mode and Host Mode. On Demand Mode allows for an interactive session to be initiated directly with Support by clicking on an Icon on the Revcord Server or even a User's Workstation. In addition, a User can be sent a link via email or Instant Messaging. Once a remote support session is requested, a Revcord Customer Support Agent or Dealer Technician will be able to connect to the system using a SHA-256 encrypted SSL connection. All Revcord Dealers will have the abilities of RevGuard, RevWatch, and remote support for sites on RevShield. In Host Mode, sessions can be automatically requested as part of an alert, by clicking a link within the Web User Interface, or by double-clicking the Request Remote Support icon on the desktop. For "Host Mode", RevWatch maintains a list of devices and their remote connection credentials securely stored in its database. Please note that none of the above-mentioned methods require any listener sockets or TCP/UDP ports to be created.

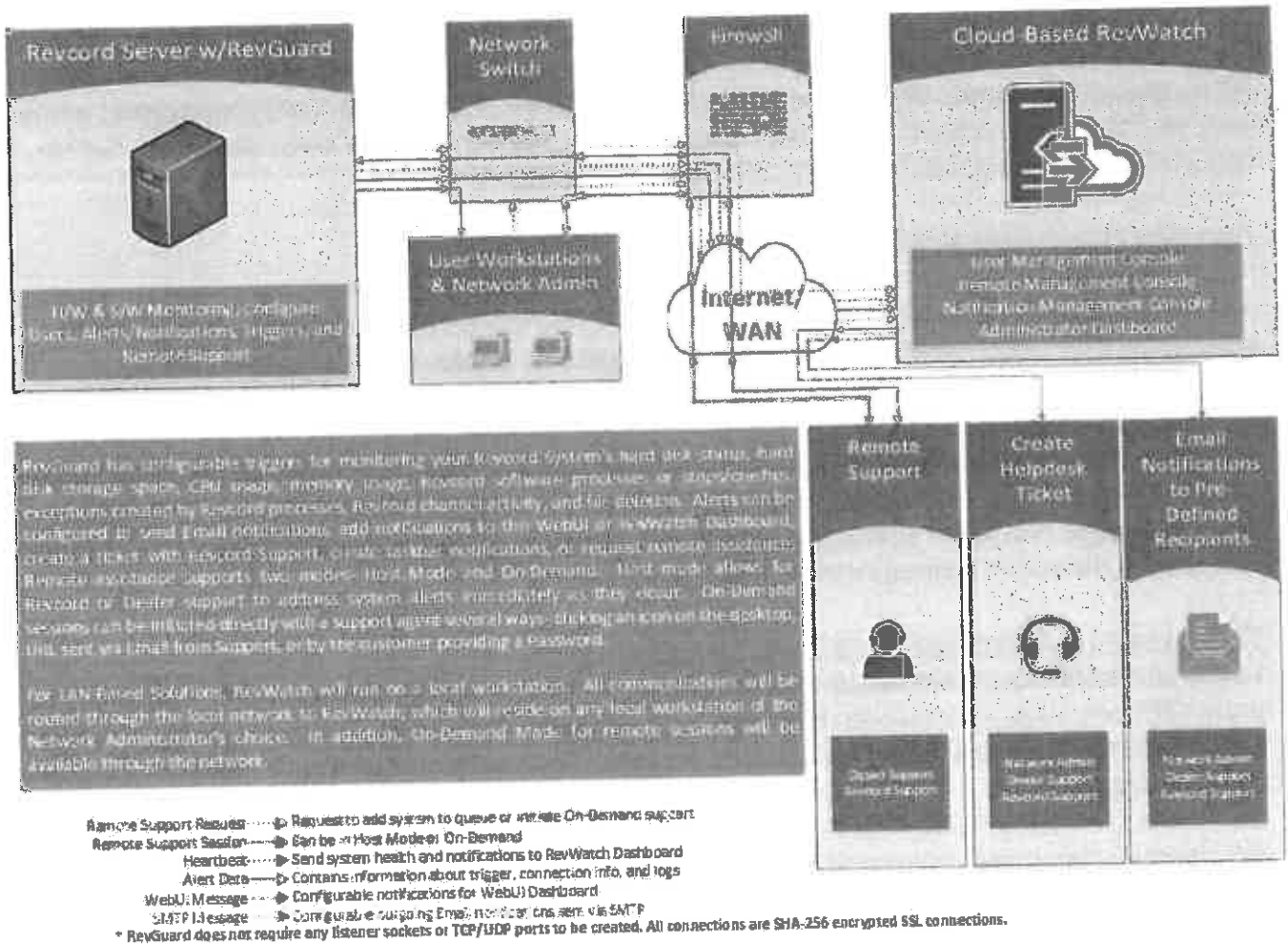

10190 Katy Freeway Suite #501
 Houston, TX 77043
 www.revcord.com



1-866-559-2188
 Local 281-404-7040
 Fax 281-404-5323
 Version 2: 4-4-2016

RevShield Software Suite

Technical Section

Based on this information, IT professionals can get a detailed picture of the software security before deploying RevGuard. Please feel free to distribute this document to your customers in order to resolve possible security concerns.

RevGuard performs two activities on the network:

- Sending Updates Out
- Creating Remote Sessions

Sending Updates

RevGuard sends a heartbeat to a remote software named RevWatch every five seconds. The software resides either on the internal network or in the cloud. The outbound heartbeat is in the form of an SSL SHA-256 Encrypted Webservice Call that goes through port 80 or a predefined custom port and contains the host name, any applicable alerts, and general system health.

Creating a Session and Types of Connections

A remote support connection can be initiated in two ways: Host-Mode session or an On-Demand session.

With a Host-Mode session, the client PC is preloaded with our Remote Support software and is constantly checking for a connection from a support agent PC. On-Demand sessions are very similar, but the system only sends the initial request when prompted by the network administrator of the client RevGuard system. The "RevWatch encryption and authentication" diagram below will help you to gain a more in-depth understanding of this data flow.

When establishing a session, RevGuard Remote Support determines the optimal type of connection. After the handshake through our master servers, a direct connection via UDP or TCP is established in 70% of all cases (even behind standard gateways, NATs and firewalls). The rest of the connections are routed through our highly redundant router network via TCP or http-tunneling. Not even we, as the operators of the routing servers, can read the encrypted data traffic.

RevShield Software Suite

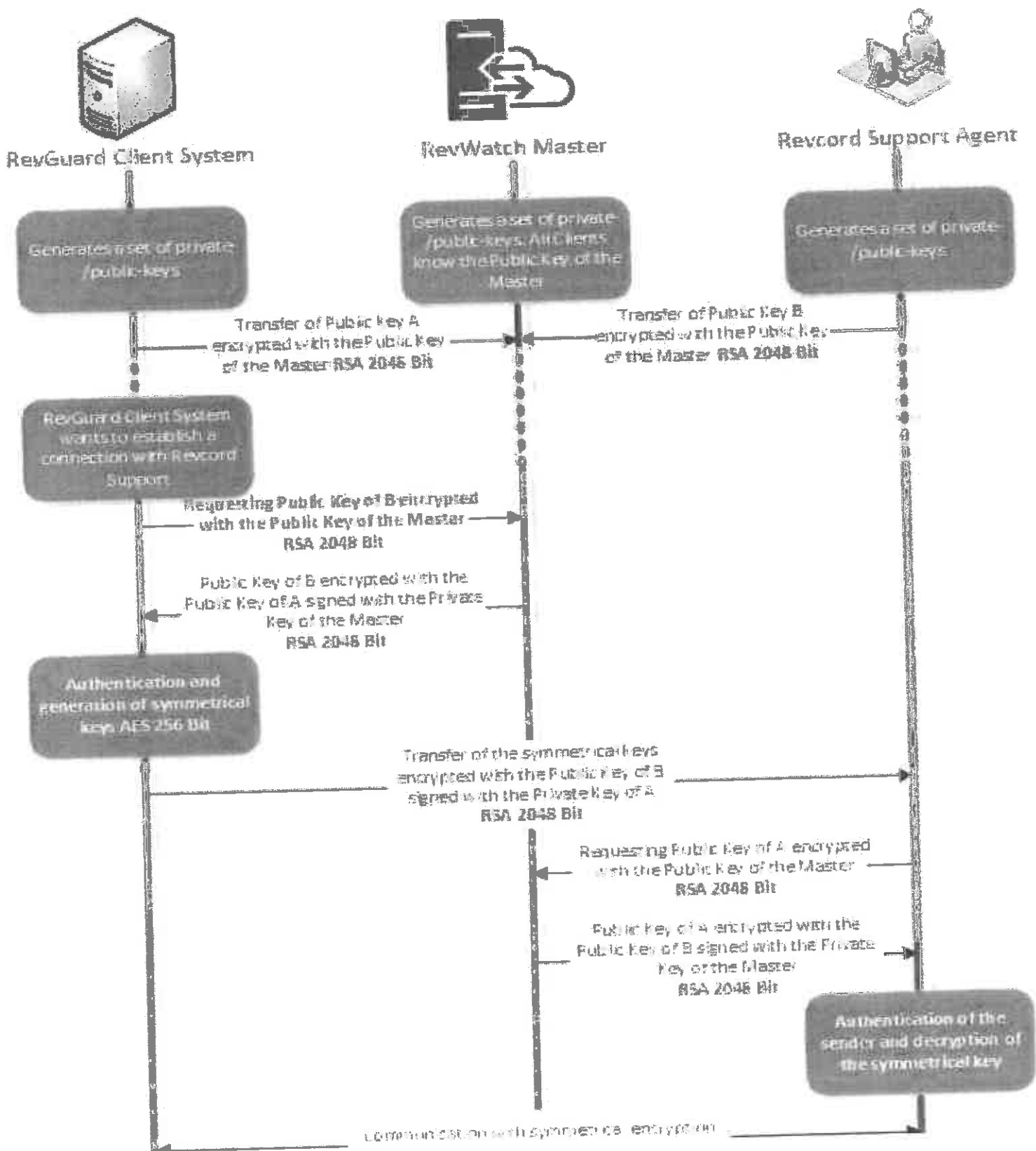

10190 Katy Freeway Suite #501
Houston, TX 77043
www.revcord.com



1-866-559-2188
Local 281-404-7040
Fax 281-404-5323
Version 2: 4-4-2016

RevShield Software Suite

Encryption and Authentication

RevGuard Remote Support Traffic is secured using RSA public/private key exchange and AES (256 bit) session encryption. This technology is used in a comparable form for https/SSL and is considered completely safe by today's standards. As the private key never leaves the client computer, this procedure ensures that interconnected computers - including the RevGuard Remote Support routing servers - cannot decipher the data stream.

Each RevGuard Remote Support client has already implemented the public key of the master cluster and can thus encrypt messages to the master cluster and check messages signed by it. The PKI (Public Key Infrastructure) effectively prevents "man-in-the-middle-attacks." Despite the encryption, the password is never sent directly, but only through a challenge-response procedure, and is only saved on the local computer.

During authentication, the password is never transferred directly because the Secure Remote Password (SRP) protocol is used. Only a password verifier is stored on the local computer.

Validation of RevGuard Remote Support IDs

RevGuard Remote Support IDs are based on various hardware and software characteristics and are automatically generated by RevGuard Remote Support. The RevGuard Remote Support servers check the validity of these IDs before every connection.

Datacenter & Backbone

These two topics concern the availability as well as the security of RevGuard Remote Support. The central RevGuard Remote Support servers are located within the European Union in ISO 27001-certified data centers with multi-redundant carrier connections and redundant power supplies. Brand-name hardware is used exclusively.

Personal access control, video camera surveillance, motion detectors, 24x7 monitoring and on-site security personnel ensure access to the data center is only granted to authorized persons and guarantee the best possible security for hardware and data. There is also a detailed identification check at the single point-of-

RevShield Software Suite

entry to the data center.

Brute-Force Protection

Prospective customers who inquire about the security of RevGuard Remote Support regularly ask about encryption. Understandably, the risk that a third party could monitor the connection or that the RevGuard Remote Support access data is being tapped is feared most. However, the reality is that rather primitive attacks are often the most dangerous ones.

In the context of computer security, a brute-force attack is a trial-and-error-method to guess a password that is protecting a resource. With the growing computing power of standard computers, the time needed for guessing long passwords has been increasingly reduced.

As a defense against brute-force attacks, RevGuard Remote Support exponentially increases the latency between connection attempts. It thus takes as many as 17 hours for 24 attempts. The latency is only reset after successfully entering the correct password. RevGuard Remote Support not only has a mechanism in place to protect its customers from attacks from one specific computer but also from multiple computers, known as botnet attacks, that are trying to access one particular

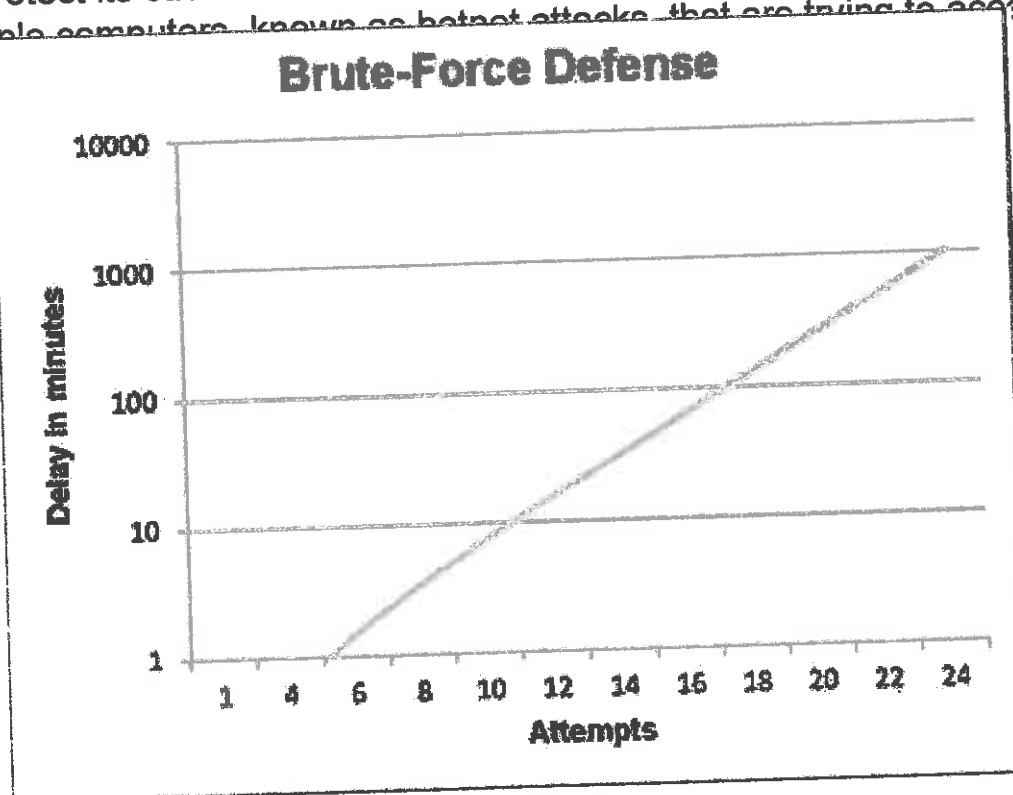

10190 Katy Freeway Suite #501
Houston, TX 77043
www.revcord.com



1-866-559-2188
Local 281-404-7040
Fax 281-404-5323
Version 2: 4-4-2016

RevShield Software Suite

RevGuard Remote Support Account

RevGuard Remote Support accounts are hosted on dedicated servers. For information on access control, please refer to Datacenter & Backbone above. For authorization and password encryption, Secure Remote Password protocol (SRP), an augmented password-authenticated key agreement (PAKE) protocol, is used. An infiltrator or man in the middle cannot obtain enough information to be able to brute-force guess a password. This means that strong security can even be obtained using weak passwords. Sensitive data within the RevGuard Remote Support account, for example cloud storage login information, is stored AES/RSA 2048 bit encrypted.

Management Console

The RevWatch Management Console is a web-based platform for user management, connection reporting and managing Computers & Contacts. All data transfer is through a secure channel using SSL (Secure Sockets Layer) encryption, the standard for secure Internet network connections. Sensitive data is furthermore stored AES/RSA 2048 bit encrypted. For authorization and password encryption,

Secure Remote Password protocol (SRP) is used. SRP is a well-established, robust, secure password-based authentication and key exchange method using 2048 bit modulus.

Warranty Statement

Revcord Warranty Statement

Five-Year Limited Hardware Warranty

All purchases of Revcord systems include a limited hardware warranty plan that covers defects in materials and workmanship. This plan is intended to cover all internal components and the chassis of any Revcord system for a period of five years from the date of purchase. Once a warranty claim has been made, the customer has two options as to how the claim is processed. First, the customer can request a RMA number from Revcord to return the non-functioning Revcord system directly to the Revcord Facility. Second, the Customer can request that a replacement component be shipped to customer next business day subject to availability. The customer should specify to the Revcord support agent how the claim is to be handled. It is up to the customer to handle any site or scheduling conflicts. Note that all incoming calls must be received by 2:00 PM CST to qualify for Next Business Day Delivery Service. All warranty claims and the shipping charges are subject to rejection after inspection and validation by the Revcord Service Facility. If it is determined that damage, neglect, or acts of God have caused the failure of the Revcord System or part, the warranty claim will be rejected and a Revcord Service Agent will contact the customer to discuss repair options. Please note that all replacement parts and any hardware used to upgrade an existing system carries a 90 day warranty.

One Year Limited Software Warranty

With the purchase of a Revcord system, the Buyer gets a one year software warranty. In addition, one year of RevShield is included at the RSSTD rate. This plan provides for Help Desk support and In Version Software Upgrades, Patches, and Hot Fixes based upon the Severity Levels outlined in RevShield Service Level Agreement. Please see the Revcord Service Level Agreement for further detail.

OTHER WARRANTIES, LIMITATION OF LIABILITY

1. Revcord warrants that its products, at the time of shipment by Revcord, are free from defect in material or workmanship for the respective warranty periods as specified above.
2. To assure conformance with operating limitations, Buyer should refer to the applicable data sheet.
3. The warranty is void (i) if the Product is not operated in conformance with installation, environmental, mechanical or electrical requirements, or within thermal stress limits, or (ii) to the extent that any malfunction is the result of misuse, abuse, improper installation or application, alteration, accident, or negligence in use, storage, transportation, or handling, or if the original identification markings on the Product have been removed, defaced or altered.

Revcord Warranty Statement

4. The foregoing warranty is subject to Buyer's (i) promptly written claim and (ii) timely provision to Revcord of an opportunity to inspect and test the Product claimed to be defective. Such inspection may be on Buyer's premises and/or Revcord may request the return of the Product at Buyer's expense. However, Revcord shall not be responsible for packing, inspection, or labor costs in connection with the return of Product. No Product shall be accepted for warranty service that is not accompanied by a Return Authorization issued by Revcord.
5. The liability of Revcord hereunder or otherwise is solely and exclusively limited to replacement (new or refurbished Product), repair, or credit of the amortized purchase price, as Revcord may elect, for any Product which is returned by Buyer during the applicable warranty period, or services for which timely notice of defect has been given by Buyer, and which are found by Revcord to be subject to adjustment under this warranty.
6. Revcord's warranty shall not be enlarged, diminished, or affected by, and no obligation or liability shall arise or grow out of Revcord's rendering of technical advice, facilities, or services in connection with Buyer's order or the products furnished hereunder.
7. REVCORD MAKES NO OTHER OR FURTHER WARRANTY, EXPRESS OR IMPLIED, INCLUDING ANY WARRANTY OF FITNESS FOR A PARTICULAR PURPOSE OR WARRANTY OF MERCHANTABILITY.
8. IN NO EVENT SHALL REVCORD BE LIABLE FOR SPECIAL, INDIRECT, INCIDENTAL, OR CONSEQUENTIAL DAMAGES, LOSS OF ANTICIPATED PROFIT, OR OTHER ECONOMIC LOSS OR FOR ANY DAMAGES ARISING IN TORT WHETHER BY REASON OF STRICT LIABILITY, NEGLIGENCE, OR OTHERWISE REGARDLES OF WHETHER IT HAS BEEN APPRISED OF THE POSSIBILITY OF SUCH.