



Department of Administration
 Purchasing Division
 2019 Washington Street East
 Post Office Box 50130
 Charleston, WV 25305-0130

**State of West Virginia
 Solicitation Response**

Proc Folder: 938509
Solicitation Description: Addendum 1: Asphalt Materials, Delivery & Labor by Vendor
Proc Type: Agency Master Agreement

Solicitation Closes	Solicitation Response	Version
2021-11-30 14:30	SR 0803 ESR11302100000003407	1

VENDOR
 000000203089
 WEST VIRGINIA PAVING INC

Solicitation Number: ARFQ 0803 DOT2200000014
Total Bid: 0
Response Date: 2021-11-30
Response Time: 12:27:59
Comments:

FOR INFORMATION CONTACT THE BUYER
 Dusty J Smith
 (304) 558-2063
 dusty.j.smith@wv.gov

Vendor Signature X **FEIN#** **DATE**

All offers subject to all terms and conditions contained in this solicitation

Line	Comm Ln Desc	Qty	Unit Issue	Unit Price	Ln Total Or Contract Amount
1	Asphalt	0.00000	TON	0.000000	0.00

Comm Code	Manufacturer	Specification	Model #
30121601			

Commodity Line Comments:

Extended Description:

Asphalt



**State of West Virginia
Agency Request for Quote
Highways**

Proc Folder: 938509

Doc Description: Addendum 1: Asphalt Materials, Delivery & Labor by Vendor

Reason for Modification:

Addendum 1 : Responses to Questions

Proc Type: Agency Master Agreement

Date Issued	Solicitation Closes	Solicitation No	Version
2021-11-12	2021-11-30 14:30	ARFQ 0803 DOT2200000014	2

FINANCE & ADMINISTRATION
DIVISION OF HIGHWAYS
BLDG 5, RM A-260
1900 KANAWHA BLVD E
CHARLESTON WV 25302
US

VENDOR

Vendor Customer Code: 000000203089

Vendor Name : West Virginia Paving, Inc.

Address : 2950 Charles Ave.

Street :

City : Dunbar

State : WV

Country : US

Zip : 25560

Principal Contact : Rick Johnson

Vendor Contact Phone: 304-768-9733

Extension: 6404

FOR INFORMATION CONTACT THE BUYER

Dusty J Smith
(304) 558-2063
dusty.j.smith@wv.gov



Vendor Signature X

Robert D. [Signature]

FEIN# 55-0570769

DATE November 30, 2021

All offers subject to all terms and conditions contained in this solicitation

ADDITIONAL INFORMATION

Addendum No.1 is issued for the following reasons:

1) To publish a copy of the vendor's questions with the responses given.

2) Uploading of the revised ATT A : Pricing Page

No other changing.

INVOICE TO | **SHIP TO**

VARIOUS AGENCY
LOCATIONS
AS INDICATED BY ORDER

VARIOUS AGENCY
LOCATIONS
AS INDICATED BY ORDER

No City WV
US

No City WV
US

Line	Comm Ln Desc	Qty	Unit Issue	Unit Price	Total Price
1	Asphalt	0.00000	TON		

Comm Code	Manufacturer	Specification	Model #
30121601			

Extended Description:

Asphalt

SCHEDULE OF EVENTS

<u>Line</u>	<u>Event</u>	<u>Event Date</u>
1	Technical Questions due by 10:00 AM	2021-11-19

SOLICITATION NUMBER: ARFQ DOT2200000014

Addendum Number: 1

The purpose of this addendum is to modify the solicitation identified as ("Solicitation") to reflect the change(s) identified and described below.

Applicable Addendum Category:

- Modify bid opening date and time
- Modify specifications of product or service being sought
- Attachment of vendor questions and responses
- Attachment of pre-bid sign-in sheet
- Correction of error
- Other

Description of Modification to Solicitation:

Addendum No.1 is issued for the following reasons:

- 1) to publish a copy of the vendor's questions with the responses given.
- 2) Uploading of the revised ATT A : Pricing Page

No other changing.

Additional Documentation: Documentation related to this Addendum (if any) has been included herewith as Attachment A and is specifically incorporated herein by reference.

Terms and Conditions:

1. All provisions of the Solicitation and other addenda not modified herein shall remain in full force and effect.
2. Vendor should acknowledge receipt of all addenda issued for this Solicitation by completing an Addendum Acknowledgment, a copy of which is included herewith. Failure to acknowledge addenda may result in bid disqualification. The addendum acknowledgement should be submitted with the bid to expedite document processing.

ATTACHMENT A

**Asphalt Materials, Delivery & Labor by Vendor by County
6622C012**

To answer vendor posed questions.

Question #1: Do the specifications specify what plant I have to pull from?

Response #1: The specifications do not specify what plant the vendor must to pull from, however, per Section 3.3.1. "All materials used on this contract shall be from WVDOH Approved Sources/Plants, as amended." Each set of **Pricing Pages (ATT A)** require a corresponding **Asphalt Plant Location Information Form (ATT C)** and **Stone Plant Location Information Form (ATT D)**. The Vendor specifies on these forms which counties their named plants will service. The Vendor may choose which plant to use to fill orders from of those available for the county bid, however, mileage paid will be calculated from the plant location closest to the mid-point of the WVDOH project site.

Question #2: Can I list all of our plants under one pricing and then I have the option on what plant to pull from?

Response #2: Yes. Please see Response #1 above, as it addresses this question as well. Additional information on this topic is also available in Section 7.2, Pricing Pages and Plant Information Forms, in the Contract Specifications.

Question #3: On Items U&V they refer to Item S – Pavement Repair.....should they be referred to Item T Asphalt HPTO

Response#3: The Contract Item Descriptions for Contract Items U & V on the Pricing Pages (ATT A) cross referenced Contract Item S, in error - Contract Item T should have cross referenced (HPTO).

Similar corrections have been made to the Contract Item Descriptions for Contract Items G & R as well. This has been corrected on the revised Pricing Pages, Attachment A (ATT A), in red text.

ADDENDUM ACKNOWLEDGEMENT FORM

SOLICITATION NO.: ARFQ DOT22000000

ARFQ 0803 DOT2200000014

Instructions: Please acknowledge receipt of all addenda issued with this solicitation by completing this addendum acknowledgment form. Check the box next to each addendum received and sign below. Failure to acknowledge addenda may result in bid disqualification.

Acknowledgment: I hereby acknowledge receipt of the following addenda and have made the necessary revisions to my proposal, plans and/or specification, etc.

Addendum Numbers Received:

(Check the box next to each addendum received)

- | | |
|--|--|
| <input checked="" type="checkbox"/> Addendum No. 1 | <input type="checkbox"/> Addendum No. 6 |
| <input type="checkbox"/> Addendum No. 2 | <input type="checkbox"/> Addendum No. 7 |
| <input type="checkbox"/> Addendum No. 3 | <input type="checkbox"/> Addendum No. 8 |
| <input type="checkbox"/> Addendum No. 4 | <input type="checkbox"/> Addendum No. 9 |
| <input type="checkbox"/> Addendum No. 5 | <input type="checkbox"/> Addendum No. 10 |

I understand that failure to confirm the receipt of addenda may be cause for rejection of this bid. I further understand that any verbal representation made or assumed to be made during any oral discussion held between Vendor's representatives and any state personnel is not binding. Only the information issued in writing and added to the specifications by an official addendum is binding.

West Virginia Paving, Inc.

Company

Robert B. Boshovec

Authorized Signature

November 30, 2021

Date

NOTE: This addendum acknowledgement should be submitted with the bid to expedite document processing.

Revised 6/8/2012

**INSTRUCTIONS TO VENDORS SUBMITTING BIDS
(Agency Delegated Procurements Only)**

1. REVIEW DOCUMENTS THOROUGHLY: The attached documents contain a solicitation for bids. Please read these instructions and all documents attached in their entirety. These instructions provide critical information about requirements that if overlooked could lead to disqualification of a Vendor's bid. All bids must be submitted in accordance with the provisions contained in these instructions and the Solicitation. Failure to do so may result in disqualification of Vendor's bid.

2. MANDATORY TERMS: The Solicitation may contain mandatory provisions identified by the use of the words "must," "will," and "shall." Failure to comply with a mandatory term in the Solicitation will result in bid disqualification.

2A. PREBID MEETING: The item identified below shall apply to this Solicitation.

A pre-bid meeting will not be held prior to bid opening

A MANDATORY PRE-BID meeting will be held at the following place and time:

All Vendors submitting a bid must attend the mandatory pre-bid meeting. Failure to attend the mandatory pre-bid meeting shall result in disqualification of the Vendor's bid. No one individual is permitted to represent more than one vendor at the pre-bid meeting. Any individual that does attempt to represent two or more vendors will be required to select one vendor to which the individual's attendance will be attributed. The vendors not selected will be deemed to have not attended the pre-bid meeting unless another individual attended on their behalf. The required attribution of attendance to a single vendor should be addressed during the pre-bid but may occur at any time deemed appropriate by the Purchasing Division.

An attendance sheet provided at the pre-bid meeting shall serve as the official document verifying attendance. Any person attending the pre-bid meeting on behalf of a Vendor must list on the attendance sheet his or her name and the name of the Vendor he or she is representing.

Additionally, the person attending the pre-bid meeting should include the Vendor's E-Mail address, phone number, and Fax number on the attendance sheet. It is the Vendor's responsibility to locate the attendance sheet and provide the required information. Failure to complete the attendance sheet as required may result in disqualification of Vendor's bid.

All Vendors should arrive prior to the starting time for the pre-bid. Vendors who arrive after the starting time but prior to the end of the pre-bid will be permitted to sign in, but are charged with knowing all matters discussed at the pre-bid.

Questions submitted at least five business days prior to a scheduled pre-bid will be discussed at

the pre-bid meeting if possible. Any discussions or answers to questions at the pre-bid meeting are preliminary in nature and are non-binding. Official and binding answers to questions will be published in a written addendum to the Solicitation prior to bid opening.

3. BID SUBMISSION: All bids must be submitted electronically through wvOASIS or signed and delivered by the Vendor to the Agency on or before the date and time of the bid opening. Any bid received by the Agency staff is considered to be in the possession of the Agency and will not be returned for any reason.

3A. BID SUBMISSION

A bid that is not submitted electronically through wvOASIS should contain the information listed below on the face of the envelope or the bid may be rejected by the Agency.

SEALED BID: Asphalt Materials, Delivery & Labor by Vendor by County
BUYER: Dusty Smith
SOLICITATION NO.: ARFQ DOT2200000014
BID OPENING DATE: 11/30/2021
BID OPENING TIME: 2:30PM
FAX NUMBER: 304.558.0047

4. ADDENDUM ACKNOWLEDGEMENT: Changes or revisions to this Solicitation will be made by an official addendum issued by the Agency. Vendor should acknowledge receipt of all addenda issued with this Solicitation by completing an Addendum Acknowledgment Form, a copy of which is included herewith. Failure to acknowledge addenda may result in bid disqualification. The addendum acknowledgement should be submitted with the bid to expedite document processing.

5. BID FORMATTING: Vendor should type or electronically enter the information onto its bid to prevent errors in the evaluation. Failure to type or electronically enter the information may result in bid disqualification.

6. ALTERNATE MODEL OR BRAND: Unless the box below is checked, any model, brand, or specification listed in this Solicitation establishes the acceptable level of quality only and is not intended to reflect a preference for, or in any way favor, a particular brand or vendor. Vendors may bid alternates to a listed model or brand provided that the alternate is at least equal to the model or brand and complies with the required specifications. The equality of any alternate being bid shall be determined by the State at its sole discretion. Any Vendor bidding an alternate model or brand should clearly identify the alternate items in its bid and should include manufacturer's specifications, industry literature, and/or any other relevant documentation demonstrating the equality of the alternate items. Failure to provide information for alternate items may be grounds for rejection of a Vendor's bid.

This Solicitation is based upon a standardized commodity established under West Virginia Code § 5A-3-61. Vendors are expected to bid the standardized commodity identified. Failure to bid the standardized commodity will result in your firm's bid being rejected.

7. EXCEPTIONS AND CLARIFICATIONS: The Solicitation contains the specifications that shall form the basis of a contractual agreement. Vendor shall clearly mark any exceptions,
Revised 04/21/2021

clarifications, or other proposed modifications in its bid. Exceptions to, clarifications of, or modifications of a requirement or term and condition of the Solicitation may result in bid disqualification.

8. REGISTRATION: Prior to Contract award, the apparent successful Vendor must be properly registered with the West Virginia Purchasing Division and must have paid the \$125 fee, if applicable.

9. UNIT PRICE: Unit prices shall prevail in cases of a discrepancy in the Vendor's bid.

10. PREFERENCE: Vendor Preference may be requested in purchases of motor vehicles or construction and maintenance equipment and machinery used in highway and other infrastructure projects. Any request for preference must be submitted in writing with the bid, must specifically identify the preference requested with reference to the applicable subsection of West Virginia Code § 5A-3-37, and must include with the bid any information necessary to evaluate and confirm the applicability of the requested preference. A request form to help facilitate the request can be found at: <http://www.state.wv.us/admin/purchase/vrc/Venpref.pdf>.

10A. RECIPROCAL PREFERENCE: The State of West Virginia applies a reciprocal preference to all solicitations for commodities and printing in accordance with W. Va. Code § 5A-3-37(b). In effect, if reciprocal preference is requested by a West Virginia resident vendor, non-resident vendors receiving a preference in their home states, will see that same preference granted to West Virginia resident vendors bidding against them in West Virginia. Any request for reciprocal preference must include with the bid any information necessary to evaluate and confirm the applicability of the preference. A request form to help facilitate the request can be found at: <http://www.state.wv.us/admin/purchase/vrc/Venpref.pdf>.

11. SMALL, WOMEN-OWNED, OR MINORITY-OWNED BUSINESSES: For any solicitations publicly advertised for bid, in accordance with West Virginia Code §5A-3-37(a)(7) and W. Va. CSR § 148-22-9, any non-resident vendor certified as a small, women-owned, or minority-owned business under W. Va. CSR § 148-22-9 shall be provided the same preference made available to any resident vendor. Any non-resident small, women-owned, or minority-owned business must identify itself as such in writing, must submit that writing to the Purchasing Division with its bid, and must be properly certified under W. Va. CSR § 148-22-9 prior to contract award to receive the preferences made available to resident vendors. Preference for a non-resident small, women-owned, or minority owned business shall be applied in accordance with W. Va. CSR § 148-22-9.

12. ELECTRONIC FILE ACCESS RESTRICTIONS: Vendor must ensure that its submission in wvOASIS can be accessed and viewed by the Agency staff immediately upon bid opening. The Agency will consider any file that cannot be immediately access and viewed at the time of the bid opening (such as, encrypted files, password protected files, or incompatible files) to be blank or incomplete as context requires, and therefore unacceptable. A vendor will not be permitted to unencrypt files, remove password protections, or resubmit documents after bid opening to make a file viewable if those documents are required with the bid. A Vendor may be required to provide document passwords or removed access restrictions to allow the Agency to print or electronically save documents provided that those documents are viewable by the Agency prior to obtaining the password or removing the access restriction.

13. NON-RESPONSIBLE: The Purchasing Division Director reserves the right to reject the bid of any vendor as Non-Responsible in accordance with W. Va. Code of State Rules § 148-1-5.3, when the Director determines that the vendor submitting the bid does not have the capability to fully perform, or lacks the integrity and reliability to assure good-faith performance.”

14. ACCEPTANCE/REJECTION: The State may accept or reject any bid in whole, or in part in accordance with W. Va. Code of State Rules § 148-1-4.5. and § 148-1-6.4.b.”

15. YOUR SUBMISSION IS A PUBLIC DOCUMENT: Vendor’s entire response to the Solicitation and the resulting Contract are public documents. As public documents, they will be disclosed to the public following the bid/proposal opening or award of the contract, as required by the competitive bidding laws of West Virginia Code §§ 5A-3-1 et seq., 5-22-1 et seq., 5G-1-1 et seq. and the Freedom of Information Act in West Virginia Code §§ 29B-1-1 et seq.

DO NOT SUBMIT MATERIAL YOU CONSIDER TO BE CONFIDENTIAL, A TRADE SECRET, OR OTHERWISE NOT SUBJECT TO PUBLIC DISCLOSURE.

Submission of any bid, proposal, or other document to the Purchasing Division constitutes your explicit consent to the subsequent public disclosure of the bid, proposal, or document. The Purchasing Division will disclose any document labeled “confidential,” “proprietary,” “trade secret,” “private,” or labeled with any other claim against public disclosure of the documents, to include any “trade secrets” as defined by West Virginia Code § 47-22-1 et seq. All submissions are subject to public disclosure without notice.

**GENERAL TERMS AND CONDITIONS:
(Agency Delegated Procurements Only)**

1. CONTRACTUAL AGREEMENT: Issuance of an Award Document signed by the Agency and approved as to form by the Attorney General's office, if required, constitutes acceptance by the State of this Contract made by and between the State of West Virginia and the Vendor. Vendor's signature on its bid, or on the Contract if the Contract is not the result of a bid solicitation, signifies Vendor's agreement to be bound by and accept the terms and conditions contained in this Contract.

2. DEFINITIONS: As used in this Solicitation/Contract, the following terms shall have the meanings attributed to them below. Additional definitions may be found in the specifications included with this Solicitation/Contract.

2.1. "Agency" or "Agencies" means the agency, board, commission, or other entity of the State of West Virginia that is identified on the first page of the Solicitation or any other public entity seeking to procure goods or services under this Contract.

2.2. "Bid" or "Proposal" means the vendors submitted response to this solicitation.

2.3. "Contract" means the binding agreement that is entered into between the State and the Vendor to provide the goods or services requested in the Solicitation.

2.4. "Director" means the Director of the West Virginia Department of Administration, Purchasing Division.

2.5. "Purchasing Division" means the West Virginia Department of Administration, Purchasing Division.

2.6. "Award Document" means the document signed by the Agency that identifies the Vendor as the contract holder.

2.7. "Solicitation" means the official notice of an opportunity to supply the State with goods or services.

2.8. "State" means the State of West Virginia and/or any of its agencies, commissions, boards, etc. as context requires.

2.9. "Vendor" or "Vendors" means any entity submitting a bid in response to the Solicitation, the entity that has been selected as the lowest responsible bidder, or the entity that has been awarded the Contract as context requires.

One Time Purchase: The term of this Contract shall run from the issuance of the Award Document until all of the goods contracted for have been delivered, but in no event will this Contract extend for more than one fiscal year.

Other: See attached.

4. AUTHORITY TO PROCEED: Vendor is authorized to begin performance of this contract on the date of encumbrance listed on the front page of the Award Document unless either the box for “Fixed Period Contract” or “Fixed Period Contract with Renewals” has been checked in Section 3 above. If either “Fixed Period Contract” or “Fixed Period Contract with Renewals” has been checked, Vendor must not begin work until it receives a separate notice to proceed from the State. The notice to proceed will then be incorporated into the Contract via change order to memorialize the official date that work commenced.

5. QUANTITIES: The quantities required under this Contract shall be determined in accordance with the category that has been identified as applicable to this Contract below.

Open End Contract: Quantities listed in this Solicitation/Award Document are approximations only, based on estimates supplied by the Agency. It is understood and agreed that the Contract shall cover the quantities actually ordered for delivery during the term of the Contract, whether more or less than the quantities shown.

Service: The scope of the service to be provided will be more clearly defined in the specifications included herewith.

Combined Service and Goods: The scope of the service and deliverable goods to be provided will be more clearly defined in the specifications included herewith.

One Time Purchase: This Contract is for the purchase of a set quantity of goods that are identified in the specifications included herewith. Once those items have been delivered, no additional goods may be procured under this Contract without an appropriate change order approved by the Vendor, Agency, Purchasing Division, and Attorney General’s office.

6. EMERGENCY PURCHASES: The Purchasing Division Director may authorize the Agency to purchase goods or services in the open market that Vendor would otherwise provide under this Contract if those goods or services are for immediate or expedited delivery in an emergency. Emergencies shall include, but are not limited to, delays in transportation or an unanticipated increase in the volume of work. An emergency purchase in the open market, approved by the Purchasing Division Director, shall not constitute of breach of this Contract and shall not entitle the Vendor to any form of compensation or damages. This provision does not excuse the State from fulfilling its obligations under a One Time Purchase contract.

7. REQUIRED DOCUMENTS: All of the items checked below must be provided to the Agency by the Vendor as specified below.

PERFORMANCE BOND: The apparent successful Vendor shall provide a performance bond in the amount of 100% of the contract value. The performance bond must be received by the

Agency prior to Contract award.

LABOR/MATERIAL PAYMENT BOND: The apparent successful Vendor shall provide a labor/material payment bond in the amount of 100% of the Contract value. The labor/material payment bond must be received by the Agency prior to Contract award.

MAINTENANCE BOND: The apparent successful Vendor shall provide a two (2) year maintenance bond covering the roofing system. The maintenance bond must be issued and delivered to the Agency prior to Contract award.

LICENSE(S) / CERTIFICATIONS / PERMITS: In addition to anything required under the Section of the General Terms and Conditions entitled Licensing, the apparent successful Vendor shall furnish proof of the following licenses, certifications, and/or permits upon request and in a form acceptable to the State. The request may be prior to or after contract award at the State's sole discretion.

West Virginia Contractor's License

The apparent successful Vendor shall also furnish proof of any additional licenses or certifications contained in the specifications regardless of whether or not that requirement is listed above.

8. INSURANCE: The apparent successful Vendor shall furnish proof of the insurance identified by a checkmark below and must include the State as an additional insured on each policy prior to Contract award. The insurance coverages identified below must be maintained throughout the life of this contract. Thirty (30) days prior to the expiration of the insurance policies Vendor shall provide the Agency with proof that the insurance mandated herein has been continued. Vendor must also provide Agency with immediate notice of any changes in its insurance policies, including but not limited to, policy cancelation, policy reduction, or change in insurers. The apparent successful Vendor

Revised 04/21/2021

shall also furnish proof of any additional insurance requirements contained in the specifications prior to Contract award regardless of whether or not that insurance requirement is listed in this section.

Vendor must maintain:

Commercial General Liability Insurance in at least an amount of:
1,000,000.00 _____ per occurrence.

Automobile Liability Insurance in at least an amount of: _____ per occurrence.

Professional/Malpractice/Errors and Omission Insurance in at least an amount of: _____ per occurrence. Notwithstanding the forgoing, Vendor's are not required to list the State as an additional insured for this type of policy.

Commercial Crime and Third Party Fidelity Insurance in an amount of: _____ per occurrence.

Cyber Liability Insurance in an amount of: _____ per occurrence.

Builders Risk Insurance in an amount equal to 100% of the amount of the Contract.

Pollution Insurance in an amount of: _____ per occurrence.

Aircraft Liability in an amount of: _____ per occurrence.

9. WORKERS' COMPENSATION INSURANCE: Vendor shall comply with laws relating to workers compensation, shall maintain workers' compensation insurance when required, and shall furnish proof of workers' compensation insurance upon request.

10. LIQUIDATED DAMAGES: This clause shall in no way be considered exclusive and

shall not limit the State or Agency's right to pursue any other available remedy. Vendor shall pay liquidated damages in the amount specified below or as described in the specifications:

_____ for _____

Liquidated Damages Contained in the Specifications.

Liquidated Damages Are Not Included in this Contract.

11. ACCEPTANCE: Vendor's signature on its bid, or on the certification and signature page, constitutes an offer to the State that cannot be unilaterally withdrawn, signifies that the product or service proposed by vendor meets the mandatory requirements contained in the Solicitation for that product or service, unless otherwise indicated, and signifies acceptance of the terms and conditions contained in the Solicitation unless otherwise indicated.

12. PRICING: The pricing set forth herein is firm for the life of the Contract, unless specified elsewhere within this Solicitation/Contract by the State. A Vendor's inclusion of price adjustment provisions in its bid, without an express authorization from the State in the Solicitation to do so, may result in bid disqualification. Notwithstanding the foregoing, Vendor must extend any publicly advertised sale price to the State and invoice at the lower of the contract price or the publicly advertised sale price.

13. PAYMENT IN ARREARS: Payments for goods/services will be made in arrears only upon receipt of a proper invoice, detailing the goods/services provided or receipt of the goods/services, whichever is later. Notwithstanding the foregoing, payments for software licenses, subscriptions, or maintenance may be paid annually in advance.

14. PAYMENT METHODS: Vendor must accept payment by electronic funds transfer or P-Card. (The State of West Virginia's Purchasing Card program, administered under contract by a banking institution, processes payment for goods and services through state designated credit cards.)

15. ADDITIONAL FEES: Vendor is not permitted to charge additional fees or assess additional charges that were not either expressly provided for in the solicitation published by the State of West Virginia, included in the Contract, or included in the unit price or lump sum bid amount that Vendor is required by the solicitation to provide. Including such fees or charges as notes to the solicitation may result in rejection of vendor's bid. Requesting such fees or charges be paid after the contract has been awarded may result in cancellation of the contract.

16. TAXES: The Vendor shall pay any applicable sales, use, personal property or any other taxes arising out of this Contract and the transactions contemplated thereby. The State of West Virginia is exempt from federal and state taxes and will not pay or reimburse such taxes.

17. FUNDING: This Contract shall continue for the term stated herein, contingent upon funds being appropriated by the Legislature or otherwise being made available. In the event funds are not appropriated or otherwise made available, this Contract becomes void and of no effect

beginning on July 1 of the fiscal year for which funding has not been appropriated or otherwise made available. If that occurs, the State may notify the Vendor that an alternative source of funding has been obtained and thereby avoid the automatic termination. Non-appropriation or non-funding shall not be considered an event of default.

18. CANCELLATION: The State reserves the right to cancel this Contract immediately upon written notice to the vendor if the materials or workmanship supplied do not conform to the specifications contained in the Contract. The Agency may also cancel any purchase or Contract upon 30 days written notice to the Vendor in accordance with West Virginia Code of State Rules § 148-1-5.2.b.

19. TIME: Time is of the essence with regard to all matters of time and performance in this Contract.

20. APPLICABLE LAW: This Contract is governed by and interpreted under West Virginia law without giving effect to its choice of law principles. Any information provided in specification manuals, or any other source, verbal or written, which contradicts or violates the West Virginia Constitution, West Virginia Code or West Virginia Code of State Rules is void and of no effect.

21. COMPLIANCE WITH LAWS: Vendor shall comply with all applicable federal, state, and local laws, regulations and ordinances. By submitting a bid, Vendor acknowledges that it has reviewed, understands, and will comply with all applicable laws, regulations, and ordinances. Vendor shall notify all subcontractors providing commodities or services related to this Contract that as subcontractors, they too are required to comply with all applicable laws, regulations, and ordinances.

22. ARBITRATION: Any references made to arbitration contained in this Contract, Vendor's bid, or in any American Institute of Architects documents pertaining to this Contract are hereby deleted, void, and of no effect.

23. MODIFICATIONS: This writing is the parties' final expression of intent. Notwithstanding anything contained in this Contract to the contrary, no modification of this Contract shall be binding without mutual written consent of the Agency, and the Vendor.

24. WAIVER: The failure of either party to insist upon a strict performance of any of the terms or provision of this Contract, or to exercise any option, right, or remedy herein contained, shall not be construed as a waiver or a relinquishment for the future of such term, provision, option, right, or remedy, but the same shall continue in full force and effect. Any waiver must be expressly stated in writing and signed by the waiving party.

25. SUBSEQUENT FORMS: The terms and conditions contained in this Contract shall supersede any and all subsequent terms and conditions which may appear on any form documents submitted by Vendor to the Agency or Purchasing Division such as price lists, order forms, invoices, sales agreements, or maintenance agreements, and includes internet websites or other electronic documents. Acceptance or use of Vendor's forms does not constitute acceptance of the terms and conditions contained thereon.

26. ASSIGNMENT: Neither this Contract nor any monies due, or to become due hereunder, may be assigned by the Vendor without the express written consent of the Agency and any other government agency or office that may be required to approve such assignments.

27. WARRANTY: The Vendor expressly warrants that the goods and/or services covered by this Contract will: (a) conform to the specifications, drawings, samples, or other description furnished or specified by the Agency; (b) be merchantable and fit for the purpose intended; and (c) be free from defect in material and workmanship.

28. STATE EMPLOYEES: State employees are not permitted to utilize this Contract for personal use and the Vendor is prohibited from permitting or facilitating the same.

29. PRIVACY, SECURITY, AND CONFIDENTIALITY: The Vendor agrees that it will not disclose to anyone, directly or indirectly, any such personally identifiable information or other confidential information gained from the Agency, unless the individual who is the subject of the information consents to the disclosure in writing or the disclosure is made pursuant to the Agency's policies, procedures, and rules. Vendor further agrees to comply with the Confidentiality Policies and Information Security Accountability Requirements, set forth in <http://www.state.wv.us/admin/purchase/privacy/default.html>

30. YOUR SUBMISSION IS A PUBLIC DOCUMENT: Vendor's entire response to the Solicitation and the resulting Contract are public documents. As public documents, they will be disclosed to the public following the bid/proposal opening or award of the contract, as required by the competitive bidding laws of West Virginia Code §§ 5A-3-1 et seq., 5-22-1 et seq., and 5G-1-1 et seq. and the Freedom of Information Act West Virginia Code §§ 29B-1-1 et seq.

DO NOT SUBMIT MATERIAL YOU CONSIDER TO BE CONFIDENTIAL, A TRADE SECRET, OR OTHERWISE NOT SUBJECT TO PUBLIC DISCLOSURE.

Submission of any bid, proposal, or other document to the Purchasing Division constitutes your explicit consent to the subsequent public disclosure of the bid, proposal, or document. The Purchasing Division will disclose any document labeled "confidential," "proprietary," "trade secret," "private," or labeled with any other claim against public disclosure of the documents, to include any "trade secrets" as defined by West Virginia Code § 47-22-1 et seq. All submissions are subject to public disclosure without notice.

31. LICENSING: In accordance with West Virginia Code of State Rules § 148-1-6.1.e, Vendor must be licensed and in good standing in accordance with any and all state and local laws and requirements by any state or local agency of West Virginia, including, but not limited to, the West Virginia Secretary of State's Office, the West Virginia Tax Department, West Virginia Insurance Commission, or any other state agency or political subdivision. Obligations related to political subdivisions may include, but are not limited to, business licensing, business and occupation taxes, inspection compliance, permitting, etc. Upon request, the Vendor must provide all necessary releases to obtain information to enable the Purchasing Division Director or the Agency to verify that the Vendor is licensed and in good standing with the above entities. Vendor shall notify all subcontractors providing commodities or services related to this Contract that as subcontractors, they too are required to be licensed, in good standing, and up-to-date on all state and local obligations as described in this section.

32. ANTITRUST: In submitting a bid to, signing a contract with, or accepting an Award Document from any agency of the State of West Virginia, the Vendor agrees to convey, sell, assign, or transfer to the State of West Virginia all rights, title, and interest in and to all causes of action it may now or hereafter acquire under the antitrust laws of the United States and the State of West Virginia for price fixing and/or unreasonable restraints of trade relating to the particular commodities or services purchased or acquired by the State of West Virginia. Such assignment shall be made and become effective at the time the purchasing agency tenders the initial payment to Vendor.

33. VENDOR CERTIFICATIONS: By signing its bid or entering into this Contract, Vendor certifies (1) that its bid or offer was made without prior understanding, agreement, or connection with any corporation, firm, limited liability company, partnership, person or entity submitting a bid or offer for the same material, supplies, equipment or services; (2) that its bid or offer is in all respects fair and without collusion or fraud; (3) that this Contract is accepted or entered into without any prior understanding, agreement, or connection to any other entity that could be considered a violation of law; and (4) that it has reviewed this Solicitation in its entirety; understands the requirements, terms and conditions, and other information contained herein. Vendor's signature on its bid or offer also affirms that neither it nor its representatives have any interest, nor shall acquire any interest, direct or indirect, which would compromise the performance of its services hereunder. Any such interests shall be promptly presented in detail to the Agency. The individual signing this bid or offer on behalf of Vendor certifies that he or she is authorized by the Vendor to execute this bid or offer or any documents related thereto on

Vendor's behalf; that he or she is authorized to bind the Vendor in a contractual relationship; and that, to the best of his or her knowledge, the Vendor has properly registered with any State agency that may require registration.

34. VENDOR RELATIONSHIP: The relationship of the Vendor to the State shall be that of an independent contractor and no principal-agent relationship or employer-employee relationship is contemplated or created by this Contract. The Vendor as an independent contractor is solely liable for the acts and omissions of its employees and agents. Vendor shall be responsible for selecting, supervising, and compensating any and all individuals employed pursuant to the terms of this Solicitation and resulting contract. Neither the Vendor, nor any employees or subcontractors of the Vendor, shall be deemed to be employees of the State for any purpose whatsoever. Vendor shall be exclusively responsible for payment of employees and contractors for all wages and salaries, taxes, withholding payments, penalties, fees, fringe benefits, professional liability insurance premiums, contributions to insurance and pension, or other deferred compensation plans, including but not limited to, Workers' Compensation and Social Security obligations, licensing fees, etc. and the filing of all necessary documents, forms, and returns pertinent to all of the foregoing. Vendor shall hold harmless the State, and shall provide the State and Agency with a defense against any and all claims including, but not limited to, the foregoing payments, withholdings, contributions, taxes, Social Security taxes, and employer income tax returns.

35. INDEMNIFICATION: The Vendor agrees to indemnify, defend, and hold harmless the State and the Agency, their officers, and employees from and against: (1) Any claims or losses for services rendered by any subcontractor, person, or firm performing or supplying services,

materials, or supplies in connection with the performance of the Contract; (2) Any claims or losses resulting to any person or entity injured or damaged by the Vendor, its officers, employees, or subcontractors by the publication, translation, reproduction, delivery, performance, use, or disposition of any data used under the Contract in a manner not authorized by the Contract, or by Federal or State statutes or regulations; and (3) Any failure of the Vendor, its officers, employees, or subcontractors to observe State and Federal laws including, but not limited to, labor and wage and hour laws.

36. PURCHASING AFFIDAVIT: In accordance with West Virginia Code §§ 5A-3-10a and 5-22-1(i), the State is prohibited from awarding a contract to any bidder that owes a debt to the State or a political subdivision of the State, Vendors are required to sign, notarize, and submit the Purchasing Affidavit to the Purchasing Division affirming under oath that it is not in default on any monetary obligation owed to the state or a political subdivision of the state.

37. CONFLICT OF INTEREST: Vendor, its officers or members or employees, shall not presently have or acquire an interest, direct or indirect, which would conflict with or compromise the performance of its obligations hereunder. Vendor shall periodically inquire of its officers, members and employees to ensure that a conflict of interest does not arise. Any conflict of interest discovered shall be promptly presented in detail to the Agency.

38. REPORTS: Vendor shall provide the Agency and/or the Purchasing Division with the following reports identified by a checked box below:

Such reports as the Agency and/or the Purchasing Division may request. Requested reports may include, but are not limited to, quantities purchased, agencies utilizing the contract, total contract expenditures by agency, etc.

Quarterly reports detailing the total quantity of purchases in units and dollars, along with a listing of purchases by agency. Quarterly reports should be delivered to the Purchasing Division via email at purchasing.division@wv.gov.

39. BACKGROUND CHECK: In accordance with W. Va. Code § 15-2D-3, the State reserves the right to prohibit a service provider's employees from accessing sensitive or critical information or to be present at the Capitol complex based upon results addressed from a criminal background check. Service providers should contact the West Virginia Division of Protective Services by phone at (304) 558-9911 for more information.

40. PREFERENCE FOR USE OF DOMESTIC STEEL PRODUCTS: Except when authorized by the Director of the Purchasing Division pursuant to W. Va. Code § 5A-3-56, no contractor may use or supply steel products for a State Contract Project other than those steel products made in the United States. A contractor who uses steel products in violation of this section may be subject to civil penalties pursuant to W. Va. Code § 5A-3-56. As used in this section:

a. "State Contract Project" means any erection or construction of, or any addition to, alteration of or other improvement to any building or structure, including, but not limited to, roads or highways, or the installation of any heating or cooling or ventilating plants or other equipment,

or the supply of and materials for such projects, pursuant to a contract with the State of West Virginia for which bids were solicited on or after June 6, 2001.

b. "Steel Products" means products rolled, formed, shaped, drawn, extruded, forged, cast, fabricated or otherwise similarly processed, or processed by a combination of two or more or such operations, from steel made by the open heath, basic oxygen, electric furnace, Bessemer or other steel making process. The Purchasing Division Director may, in writing, authorize the use of foreign steel products if:

c. The cost for each contract item used does not exceed one tenth of one percent (.1%) of the total contract cost or two thousand five hundred dollars (\$2,500.00), whichever is greater. For the purposes of this section, the cost is the value of the steel product as delivered to the project; or

d. The Director of the Purchasing Division determines that specified steel materials are not produced in the United States in sufficient quantity or otherwise are not reasonably available to meet contract requirements.

41. PREFERENCE FOR USE OF DOMESTIC ALUMINUM, GLASS, AND STEEL: In Accordance with W. Va. Code § 5-19-1 et seq., and W. Va. CSR § 148-10-1 et seq., for every contract or subcontract, subject to the limitations contained herein, for the construction, reconstruction, alteration, repair, improvement or maintenance of public works or for the purchase of any item of machinery or equipment to be used at sites of public works, only domestic aluminum, glass or steel products shall be supplied unless the spending officer determines, in writing, after the receipt of offers or bids, (1) that the cost of domestic aluminum, glass or steel products is unreasonable or inconsistent with the public interest of the State of West Virginia, (2) that domestic aluminum, glass or steel products are not produced in sufficient quantities to meet the contract requirements, or (3) the available domestic aluminum, glass, or steel do not meet the contract specifications. This provision only applies to public works contracts awarded in an amount more than fifty thousand dollars (\$50,000) or public works contracts that require more than ten thousand pounds of steel products.

The cost of domestic aluminum, glass, or steel products may be unreasonable if the cost is more than twenty percent (20%) of the bid or offered price for foreign made aluminum, glass, or steel products. If the domestic aluminum, glass or steel products to be supplied or produced in a "substantial labor surplus area", as defined by the United States Department of Labor, the cost of domestic aluminum, glass, or steel products may be unreasonable if the cost is more than thirty percent (30%) of the bid or offered price for foreign made aluminum, glass, or steel products. This preference shall be applied to an item of machinery or equipment, as indicated above, when the item is a single unit of equipment or machinery manufactured primarily of aluminum, glass or steel, is part of a public works contract and has the sole purpose or of being a permanent part of a single public works project. This provision does not apply to equipment or machinery purchased by a spending unit for use by that spending unit and not as part of a single public works project.

All bids and offers including domestic aluminum, glass or steel products that exceed bid or offer prices including foreign aluminum, glass or steel products after application of the preferences provided in this provision may be reduced to a price equal to or lower than the lowest bid or

offer price for foreign aluminum, glass or steel products plus the applicable preference. If the reduced bid or offer prices are made in writing and supersede the prior bid or offer prices, all bids or offers, including the reduced bid or offer prices, will be reevaluated in accordance with this rule.

42. PROHIBITION AGAINST USED OR REFURBISHED: Unless expressly permitted in the solicitation published by the State, Vendor must provide new, unused commodities, and is prohibited from supplying used or refurbished commodities, in fulfilling its responsibilities under this Contract.

43. VOID CONTRACT CLAUSES – This Contract is subject to the provisions of West Virginia Code § 5A-3-62, which automatically voids certain contract clauses that violate State law.

DESIGNATED CONTACT: Vendor appoints the individual identified in this Section as the Contract Administrator and the initial point of contact for matters relating to this Contract.

Rick Johnson Chief Estimator
(Name, Title)
Rick Johnson Chief Estimator
(Printed Name and Title)
2950 Charles Ave. Dunbar WV 25064
(Address)
304-768-9733 304-768-9351
(Phone Number) / (Fax Number)
rjohnson@wvpaving.com
(E-mail address)

CERTIFICATION AND SIGNATURE: By signing below, or submitting documentation through wvOASIS, I certify that I have reviewed this Solicitation in its entirety; that I understand the requirements, terms and conditions, and other information contained herein; that this bid, offer or proposal constitutes an offer to the State that cannot be unilaterally withdrawn; that the product or service proposed meets the mandatory requirements contained in the Solicitation for that product or service, unless otherwise stated herein; that the Vendor accepts the terms and conditions contained in the Solicitation, unless otherwise stated herein; that I am submitting this bid, offer or proposal for review and consideration; that I am authorized by the vendor to execute and submit this bid, offer, or proposal, or any documents related thereto on vendor's behalf; that I am authorized to bind the vendor in a contractual relationship; and that to the best of my knowledge, the vendor has properly registered with any State agency that may require registration.

By signing below, I further certify that I understand this Contract is subject to the provisions of West Virginia Code § 5A-3-62, which automatically voids certain contract clauses that violate State law.

West Virginia Paving, Inc.
(Company)

(Authorized Signatory) (Representative Name, Title)



Robert Brookover Vice President
(Printed Name and Title of Authorized Representative)

November 30, 2021
(Date)

304-768-9733 304-768-9351
(Phone Number) (Fax Number)

ADDENDUM ACKNOWLEDGEMENT FORM

SOLICITATION NO.: ARFQ 0803 DOT2200000014

Instructions: Please acknowledge receipt of all addenda issued with this solicitation by completing this addendum acknowledgment form. Check the box next to each addendum received and sign below. Failure to acknowledge addenda may result in bid disqualification. Acknowledgment: I hereby acknowledge receipt of the following addenda and have made the necessary revisions to my proposal, plans and/or specification, etc.

Addendum Numbers Received:

(Check the box next to each addendum received)

- | | |
|--|--|
| <input checked="" type="checkbox"/> Addendum No. 1 | <input type="checkbox"/> Addendum No. 6 |
| <input type="checkbox"/> Addendum No. 2 | <input type="checkbox"/> Addendum No. 7 |
| <input type="checkbox"/> Addendum No. 3 | <input type="checkbox"/> Addendum No. 8 |
| <input type="checkbox"/> Addendum No. 4 | <input type="checkbox"/> Addendum No. 9 |
| <input type="checkbox"/> Addendum No. 5 | <input type="checkbox"/> Addendum No. 10 |

I understand that failure to confirm the receipt of addenda may be cause for rejection of this bid. I further understand that any verbal representation made or assumed to be made during any oral discussion held between Vendor's representatives and any state personnel is not binding. Only the information issued in writing and added to the specifications by an official addendum is binding.

West Virginia Paving, Inc. _____
Company

Authorized Signature

November 30, 2021 _____
Date

NOTE: This addendum acknowledgement should be submitted with the bid to expedite document processing.

REQUEST FOR QUOTATION
Asphalt Materials, Delivery & Labor by Vendor by County

SPECIFICATIONS

1. **PURPOSE AND SCOPE:** The West Virginia Division of Highways is soliciting bids to establish an open-end Asphalt contract for use on preventive maintenance and repair projects throughout the state of West Virginia including materials, delivery and labor, by the Vendor, to WVDOH project sites.

2. **DEFINITIONS:** The terms listed below shall have the following meanings assigned to them throughout and for the purpose of this Solicitation. Additional definitions can be found in Section 2 of the General Terms and Conditions.
 - 2.1 **“Approved Source,” “Approved Plant,” “Approved Product,” or “Approved Vendor”** - Terms which refers to the Approved Product Lists (APL) of certified manufacturers and/or products that meet acceptable levels of quality as determined by WVDOH Materials Control, Soils and Testing Division (MCS&T). These lists are updated periodically, and it is the Vendors responsibility to refer to the MCS&T website to ensure compliance.
https://transportation.wv.gov/highways/mcst/Pages/APL_By_Number.aspx.
 - 2.2 **“Asphalt,” “Hot Mix Asphalt” and “HMA”** - Terms used interchangeably for asphalt.
 - 2.3 **“Contract Item” or “Contract Item(s)”** – Contract Items are identified in Section 3 of this Solicitation.
 - 2.4 **“Contractor” or “Vendor”** – interchangeable term used throughout this Solicitation and in any cited Sections of the West Virginia Department of Transportation, Division of Highways Standard Specifications, Roads and Bridges, adopted latest Standard Specs edition, as amended, including any Supplementals and refers to any entity submitting a bid in response to the Solicitation, the entity that has been selected as the lowest responsible bidder, or the entity that has been awarded the Contract, as context requires.
 - 2.5 **“Emergency Work”** – Work that is required to be done without delay owing to circumstances for which the WVDOH could not have reasonably expected and has been designated as such by, at a minimum, a WVDOH District Engineer or their designee.
 - 2.6 **“F.O.B Destination” and “Free-on-Board Destination”** – Interchangeable terms meaning a Vendor or its designee bears the freight charges, owns the goods while in transit, and will deliver goods to the location specified on the Delivery Order via truck/other conveyance without any expense to the purchaser.

REQUEST FOR QUOTATION
Asphalt Materials, Delivery & Labor by Vendor by County

- 2.7 “HPTO” - High Performance Thin Overlay.
- 2.8 “**Liquidated Damages**” - Monetary compensation due from the Vendor in the event the Vendor’s Contract Items as supplied fall short of contractual stipulation or breaches the contract. Delays in the delivery of Contract Items or supplying Items with quality failures and/or corrections needed by the Vendor may result in the Agency assessing charges for such deficiencies per these contract Specifications, the Standard Specs Section 108.7, as amended, and calculated from the table posted at the WVDOH Contract Administration’s Specifications and Documents website, as amended: <https://transportation.wv.gov/highways/contractadmin/specifications/Pages/LiquidDatedDamages.aspx>
- 2.9 “**MCS&T**” - The WVDOH Materials Control, Soil and Testing Division, who perform all procedures necessary with sampling, testing, reporting and inspection of products and materials to maintain a reliable quality assurance system. Reference: <http://www.transportation.wv.gov/highways/mcst/Pages/default.aspx>
- 2.10 “**MP**” - Material Procedures, as amended, issued by the WVDOH Materials Control, Soils and Testing Division. The MP numbers references throughout these Contract Specifications are available by MP number at: <https://transportation.wv.gov/highways/mcst/Pages/WVDOH-Materials-Procedures.aspx>
- 2.11 “**PG**” – Performance Grade.
- 2.12 “**Plant Information Form**” and “**Information Form**” - **Mandatory forms which the Vendor must complete and submit with their bid** to identify each of the Vendor’s sourced Plants. Vendor shall provide Plant name, location, and counties served for each Plant sourced for asphalt and/or stone Materials associated with this contract’s Pricing Pages. Plant Information forms are mandatory and must accompany their respective Pricing Pages and be submitted at the time of bid. **This Solicitation requires the TWO (2) Plant Information Forms: Attachment C Asphalt Plant Information Form (ATT C) and Attachment D Stone Plant Information Form (ATT D).**
- 2.13 “**Pricing Pages**” - The schedule of prices attached hereto as **Attachment A Pricing Pages (ATT A)** and **Attachment B Mobilization Pricing Pages (ATT B)** which are used to evaluate the Solicitation responses. There are TWO (2) sets of Pricing Pages.

REQUEST FOR QUOTATION
Asphalt Materials, Delivery & Labor by Vendor by County

NOTE: Vendor's Pricing Pages shall accompany and correspond with Vendor's Plant Information forms.

- 2.14 "RAP" - Reclaimed Asphalt Pavement.
- 2.15 "Solicitation" – The official notice of an opportunity to supply the State with goods and/or services that is published by the West Virginia Division of Highways.
- 2.16 "SP" - WVDOH Special Provision.
- 2.17 "Standard Specs" – The West Virginia Department of Transportation, Division of Highways Standard Specifications, Roads and Bridges, adopted latest edition, and as amended or modified by all subsequent Supplemental Specifications.
- 2.18 "WVDOH" or "Agency"– West Virginia Division of Highways.

3. GENERAL REQUIREMENTS:

- 3.1 **Standard Specifications Roads and Bridges:** The following Standard Specs Sections shall apply, as applicable, to the administration of this contract: 101, 102, 103, 104, 105, 106, 107, 108, 109, and 110, as amended.

Materials, equipment, and performance of this contract shall conform, but is not limited to, the requirements of Sections 307, 401, 408, 415, and 636, as amended.

A hard copy of the current Standard Specs may be purchased at a cost of \$20.00 (\$15.00 for the 2017 book plus \$5.00 for the Supplemental Latest Edition) using the **Attachment E (ATT E) Standard Specifications Order Form**. The completed form should be submitted by email to DOTSpecifications@wv.gov or mailed to:

West Virginia Division of Highways
Contract Administration
Building 5, Room 840
1900 Kanawha Boulevard, East
Charleston, West Virginia 25305

A free electronic copy of the Standard Specs may be obtained by sourcing:
<http://transportation.wv.gov/highways/contractadmin/specifications/Pages/default.aspx>

REQUEST FOR QUOTATION
Asphalt Materials, Delivery & Labor by Vendor by County

3.2 Mandatory Items to be Included with the Bid: The Vendor should carefully read the entire solicitation invitation. The Vendor shall include as part of their bid response:

- Certification and Signature Page
- Addendum Acknowledgement Form
- Valid West Virginia Contractor's License, if applicable.
- Contract Manager Page
- Attachments included in solicitation package (ATT A, ATT B, etc.)
- Purchasing Affidavit (properly notarized)
- Ethics/Disclosure Form (properly notarized)
- Valid Certificate of Insurance; and,
- Any other required forms or supporting information as described herein.

Omitting any required forms, attachments, or documentation as described throughout this contract will deem a bid non-responsive and may result in the disqualification of the Vendor's bid response.

3.3 Contract Items and Mandatory Requirements: Vendor shall provide Agency with the Contract Items listed below on an open-end and continuing basis. Contract Items must meet or exceed the mandatory requirements as shown below.

3.3.1 Materials:

Contract Item A is considered Materials. Materials from this contract SHALL ONLY be purchased when delivery by the Vendor and Labor by the Vendor are required on a Delivery Order. All materials used on this contract shall be from WVDOH Approved Sources/Plants, as amended.

All labor, equipment, and material to complete **Item B "Shoulder Stone Placement for Asphalt 307-Class 10"** shall be included in the unit bid price. Any traffic control required shall be charged per Section 3.3.22 of these Contract Specifications.

3.3.2 Shoulder Stone:

3.3.2.1 Shoulder Stone Placement, Section 307, Class 10, Contract Item B, shall meet the requirements of the Standard Detail for **Exhibit 1 Shoulder Reconstruction (EXH 1)** and **Exhibit 2 Restoring Shoulders for Guardrail (EXH 2)**, or as directed by the Delivery Order and the WVDOH District Engineer or their

REQUEST FOR QUOTATION
Asphalt Materials, Delivery & Labor by Vendor by County

designee and shall be bid per ton. **Shoulder Stone Placement and Stone will be paid as Contract Item B.**

3.3.2.2 Haul by Vendor – Stone, Contract Item D, is the distance over suitable routes selected by the WVDOH District Engineer or their designee using the allowed haul costs that will provide the lowest total cost to the WVDOH and shall be measured from the Vendor's Stone plant location, which shall be identified by the Vendor on **Attachment D Stone Plant Information Form (ATT D)**, to the WVDOH's mid-point of the project.

The WVDOH shall source the WV Straight Line Diagrams for WV Primary Routes and WV Secondary Routes for these routes. The Diagrams are available in each WVDOH District Office and the WVDOH Central Office. WVDOH will determine the route to be taken due to bridge and/or road restrictions which shall have acceptable load limits for both roads and bridges. Hauling of Shoulder Stone will be paid as **Contract Item D**.

3.3.2.3 Shoulder Stone Mobilization, Contract Item C, is to compensate Vendor for Mobilization of Shoulder Stone for Placement and shall be priced on **Attachment B Mobilization Pricing Pages (ATT B)** which shall correspond with Vendor's **Attachment D Stone Plant Information Form (ATT D)**. Information Form includes counties sourced for Stone.

All labor, equipment and material to complete Placement/Restoring of Stone, Contract Item B shall be included in the unit bid price. Any traffic control required shall be charged per Section 3.3.22 of these Contract Specifications.

3.3.3 Performance Grade Binder, Contract Item E, is a surcharge to compensate Vendor for supplying asphalt when the referenced binder is substituted for the standard binder.

3.3.4 Haul by Vendor – Asphalt, Contract Item F, is the distance over suitable routes selected by the WVDOH District Engineer or their designee using the allowed for haul costs that will provide the lowest total cost to the WVDOH and shall be measured from the Vendor's plant location, which shall be identified on the **Attachment C Asphalt Plant Information Form (ATT C)** to the WVDOH's mid-point of the project. The WVDOH shall source the WV Straight Line Diagrams for WV Primary Routes and WV Secondary Routes for these routes. The

REQUEST FOR QUOTATION
Asphalt Materials, Delivery & Labor by Vendor by County

Diagrams are available in each WVDOH District Office and the WVDOH Central Office. WVDOH will determine the route to be taken due to bridge and/or road restrictions which shall have acceptable load limits for both roads and bridges.

Out-of-state delivery route mileage will be calculated by the WVDOH, the shortest route, by utilizing “Google Earth” or a similar source for routing from the Vendor’s plant location to the WV State line at which time, the Diagrams will be sourced to the WVDOH mid-point of the projection location. **Haul by Vendor will only be requested in combination with other awarded items.**

3.3.5 Laydown of Materials, Contract Item G, shall provide Laydown services for Materials (**Contract Item A**). Laydown shall be provided by the Vendor at projects designated by the WVDOH District Engineer or their designee.

3.3.5.1 Safety Edge™: As per the Standard Spec Sections 410.10.2 and 401.10.6, and **Safety Edge Design Directive 650, Exhibit 3 (EXH 3)**, when the total specified lift thickness of pavement is 1.5 inches or greater, the Vendor shall construct an outside pavement edge with Safety Edge™, where appropriate as described in **Safety Edge Design Directive 650, Exhibit 3 (EXH 3)**, unless Directed otherwise by the WVDOH District Engineer or their designee. Safety Edge™ shall be installed at no additional cost to the WVDOH. Vendors must use an Approved Asphalt Safety Edge™ Device (shoe) model listed on Division Approved Product Listing at https://transportation.wv.gov/highways/mcst/Pages/APL_By_Number.aspx, as amended. **Non-Approved Asphalt Safety Edge™ Device substitutions will not be accepted.**

3.3.6 Excavation for Shoulder Paving, Contract Item I, shall consist of removing existing shoulder material for a length and width as directed by the WVDOH District Engineer or their designee in two inch (2”) vertical increments. Cost of loading, hauling, and disposing of the excavated materials shall be included in the bid price for this item.

Replacement of Asphalt Base, Asphalt Wearing or Shoulder Stone Aggregate will be paid as shown in Sections 3.3.7 and 3.3.8.

3.3.7 Asphalt Base I Shoulder Paving, Contract Item J, is a surcharge for work performed to pave road shoulders consisting of installing and

REQUEST FOR QUOTATION
Asphalt Materials, Delivery & Labor by Vendor by County

compacting Asphalt Base I to the elevation of the existing pavement in the shoulder that is to be paved.

Vendor shall comply with **Repaving Pipe Trenches in Paved Shoulders, Exhibit 4 (EXH 4)**, where relevant work is performed.

NOTE the following Asphalt Base I related line Contract Items:

- Asphalt Base I will be paid as **Contract Item A**.
- Hauling of Asphalt Base I will be paid as **Contract Item F**.
- Laydown of Base I will be paid as **Contract Item G**.
- Excavation for Base I will be paid as **Contract Item I**.

- 3.3.8 Asphalt Base II Shoulder Paving, Contract Item K**, is a surcharge for work performed to pave road shoulders consisting of installing and compacting Asphalt Base II to the elevation of the existing pavement in the shoulder that is to be paved.

Vendor shall comply with **Repaving Pipe Trenches in Paved Shoulders, Exhibit 4 (EXH 4)**, where relevant work is performed.

NOTE the following Asphalt Base II related line Contract Items:

Asphalt Base II will be paid as **Contract Item A3**.
Hauling of Asphalt Base II will be paid as **Contract Item F**.
Laydown will be paid as **Contract Item G**.
Excavation will be paid as **Contract Item I**.
Shoulder Stone Placement/Restoring, and Stone will be paid as **Contract Item B**.

- 3.3.9 Tack Coat, Contract Item L**, Asphalt Material for Tack Coat furnished and applied shall be in accordance with Standard Specs Section 408, as amended, as directed by the WVDOH District Engineer or their designee.

- 3.3.10 Additional Heel-In Joints, Contract Item M**, at the beginning and the end of each paving location will be performed by the Vendor in accordance with **Exhibit 5 Resurfacing Heel-In Detail (EXH 5)**. Additional Heel-In Joints, in accordance with the Resurfacing Heel-In Detail, may be required as directed by the WVDOH District Engineer or their designee at intersecting roadways, at the beginning and end of each paving skip, and at other designated locations. Payment of Additional Heel-In Joints shall be paid per linear foot as measured along the joint, which shall be full payment for complete construction of the joint.

REQUEST FOR QUOTATION
Asphalt Materials, Delivery & Labor by Vendor by County

3.3.11 Skip Paving Surcharge, Contract Item N. Skip Paving may be requested by the WVD OH District Engineer or their designee. A Skip Paving Surcharge will apply when the distance between the end of one skip and the beginning of the next exceeds 2,500 feet. Skip paving for distances less than 2500 feet from the end of one skip and the beginning of the next will not qualify for the Skip Paving Surcharge. Payment shall be made for each ton of final surface course material completed in place on the project. Patching and leveling in preparation for resurfacing of a project shall not be considered Skip Paving.

3.3.12 Pavement Profiling/Milling shall consist of profiling the existing pavement to the specified grade and cross slope by grinding, planing, or milling. The profiling equipment shall be capable of accurately establishing profile grades of 1/4" plus or minus, along each edge of the machine by reference from the existing pavement by use of ski or matching shoe or by reference to independent grade control. The equipment shall have an automatic system for controlling grade and cross slope. The Vendor shall provide adequate manpower and auxiliary equipment to control dust and remove cuttings from the project site. Stockpiling of cuttings on the project site will not be permitted.

The Vendor shall be responsible for damage to drainage facilities, manholes or other appurtenances within the pavement area.

3.3.12.1 Pavement Profiling/Milling, Contract Items O and P, shall be measured as the total number of square yards planed or ground to a depth not exceeding two inches (2"). Should the required removal depth exceed two inches (2"), additional quantities shall be measured for each additional two inches (2") increment.

It shall be the WVD OH District Engineer or their designee's decision who retains ownership of the Profiled/Milled Cuttings: WVD OH or the Vendor. WVD OH will designate on the Delivery Order Contract Item O, Pavement Profiling/Milling–WVD OH Owns Millings, or Contract Item P, Pavement Profiling/Milling–Vendor Owns Millings, as per Section 9.2. Vendors shall factor in the haul cost of profiled/milled cuttings up to 10 miles, one way, in the bid price of this **Contract Items O and P**, regardless of who is to retain ownership of the Millings.

REQUEST FOR QUOTATION
Asphalt Materials, Delivery & Labor by Vendor by County

3.3.12.2 Mobilization for Profiling/Milling, Contract Item Q listed on **Attachment B Mobilization Pricing Pages (ATT B)**, all preparatory operations including movement of necessary personnel and equipment onto the project site to begin the profiling work. Only one Mobilization for Profiling per Delivery Order shall be paid when Pavement Profiling/Milling and identified accordingly from **Contract Item O or P** is required.

3.3.13 Haul of Profiled/Milled Cuttings, Contract Item R: Profiled/Milled Cuttings from the project site may be hauled by either WVDOH forces or the Vendor, as determined by the WVDOH District Engineer or their designee. When WVDOH retains ownership of the millings, **Contract Item O**, hauling of Profiled/Milled Cuttings by Vendor shall be to locations designated by the WVDOH District Engineer, or their designee. When Vendor retains ownership of the millings, **Contract Item P**, hauling of Profiled/Milled Cuttings by Vendor shall be calculated to the Vendor's nearest plant location. Mileage shall be calculated using the straight-line diagram as described in Section 3.3.4.

The first 10 miles, one way, Haul of Profiled/Milled Cuttings shall be included with the bid price of the Pavement Profiling/Milling, **Contract Items O and P**, and shall not be charged for separately.

Haul of Profiled/Milled Cuttings beyond the initial 10 miles shall be bid per mile as **Contract Item R2**. **Contract Item R2** shall only be charged for mileage one way. Haul of Profiled/Milled Cuttings shall be for full capacity truckloads (legal truckloads) only, except for the last haul of the day, which permits the hauling of a partial load at the same rate.

3.3.14 Pavement Repair: Contract Item S. Pavement Repair, Contract Item S, is for pavement repair work performed in conjunction with an overlay. Pavement Repair shall consist of the squaring up the repair area, removing damaged material to a depth directed by the WVDOH District Engineer or their designee, hauling and disposing of existing pavement, tacking of existing surfaces and placing and compacting Asphalt Base II in lifts not exceeding two inches (2") to the level of the existing pavement. The cost of Asphalt Base II material shall be charged separately as **Contract Item A3**. Pavement Repair, **Contract Item S**, does not qualify for an Asphalt Price Adjustments; however, Asphalt Base II material used for Pavement Repair qualifies for price adjustment per Section 5 of these Contract Specifications.

REQUEST FOR QUOTATION
Asphalt Materials, Delivery & Labor by Vendor by County

All labor and equipment to complete **Contract Item S** shall be included in the unit bid price for **Contract Item S**. Any traffic control required shall be charged separately per Section 3.3.22 of these Contract Specifications and identified accordingly as **Contract Item AC**.

- **Base Failure Repair** shall be in accordance with **Base Failure Repair Detail, Exhibit 6 (EXH 6)**.
- **Edge Failure Repair** shall be in accordance with **Edge Failure Repair Detail, Exhibit 7 (EXH 7)**.
- **Pothole Repair** shall be in accordance with **Pothole Repair Detail, Exhibit 8 (EXH 8)**.

3.3.15 Attachment F SP401 Asphalt Base, Wearing and Patching, and Leveling Courses (ATT F), as amended, shall address the use of increased amounts of RAP used within mixes produced for projects in the WVDOH construction program.

3.3.16 Crushed Aggregate Base Course: RAP may be substituted for Class 10 Shoulder Stone materials on roadways where edge line pavement markings exist or are installed per Standard Specs Section 307, as amended.

3.3.17 Contract Item T shall be in accordance with **Attachment G Asphalt High Performance Thin Overlay, SP496 (ATT G)**, as amended. Laydown service shall be provided per Section 3.3.16.2 of these Contract Specifications.

3.3.17.1 Non-Tracking Tack, Contract Item U, is to be used with **Contract Item T**, shall be a MCS&T Approved Product from an Approved Vendor per MP, as amended, and shall meet the recommended requirements of the supplier unless otherwise specified by the WVDOH District Engineer or their designee.

3.3.17.2 Laydown of Materials, Contract Item V, shall provide Laydown services for **Asphalt HTPO, Contract Item T**. Any costs associated with the Material Transfer Device shall be included in the Vendor's bid price for Laydown. Laydown shall be provided by the Vendor at projects designated by the WVDOH District Engineer or their designee.

REQUEST FOR QUOTATION
Asphalt Materials, Delivery & Labor by Vendor by County

3.3.17.3 Asphalt HTPO, Contract Item T, shall be PG 64E - 22 ordered in 400 (four hundred) ton increments and **Contract Item V** shall also be requested in 400 (four hundred) ton increments or greater.

Hauling for **Contract Item T** shall be a separate bid item and not included in the combined material and Laydown price. Hauling shall be charged per **Contract Item F**.

3.3.18 Ultra-Thin Asphalt Overlay, Contract Item W, shall be in accordance with **Attachment H – SP498 Ultra-Thin Asphalt Overlay (ATT H)**, as amended. Laydown service shall be provided per Section 3.3.5 of these Contract Specifications.

3.3.19 Fine Milling of Asphalt Pavement Surfaces, Contract Item X, shall be the fine milling of existing and/or new asphalt pavement at locations shown on the plans or as directed by the WVDOH District Engineer or their designee in accordance with the Standard Test Method for Measuring Pavement Macrotexture Depth using a Volumetric Technique, MP 401.07.24. Vendor shall provide pricing inclusive of Laydown services.

3.3.20 Rumble Strips:

3.3.20.1 Milled Rumble Strips, Contract Item Y, shall be in accordance with the **Exhibit 9 Rumble Strip Special Detail (EXH 9)**.

3.3.20.2 Mobilization for Milled Rumble Strips, Contract Item Z, on **Attachment B Mobilization Pricing Pages (ATT B)**, is all preparatory operations including movement of necessary personnel and equipment onto the project site to begin the work of Milling Rumble Strips. Only one Mobilization for Milling Rumble Strips per Delivery Order shall be paid when **Milled Rumble Strips, Contract Item Y**, is required.

3.3.21 Parking Lot and Facility Paving Surcharge, Contract Item AA, is a surcharge which shall be provided when materials, **Contract Items A, T, and W**, are used to pave parking lots.

3.3.22 Cleaning and Sweeping, Contract Item AB, shall be calculated as the paving length times the width swept. The WVDOH shall have the option to perform Cleaning and Sweeping.

REQUEST FOR QUOTATION
Asphalt Materials, Delivery & Labor by Vendor by County

3.3.23 Maintaining Traffic: While undergoing improvement, the project site shall be kept open to traffic in such condition that both local and through traffic will be adequately and safely accommodated. All improvement operations shall be scheduled by the Vendor to keep traffic delay to a minimum.

Traffic Control may be furnished by the WVDOH at the option of the District Engineer, or their designee; however, when Pilot Truck and Driver, Traffic Control Devices, Flagger, and/or Arrow Board, **Contract Item AC**, are requested by the WVDOH District Engineer or their designee for a project, traffic shall be maintained by the Vendor in accordance with Standard Specs Section 636, as amended.

3.3.24 Mobilization for Paving Limits: Vendor shall use **Attachment B Mobilization Pricing Pages (ATT B)** to provide pricing for all Mobilization Contract Items.

Attachment B Mobilization Pricing Pages (ATT B) Contract Items are:

- **Contract Item C** is for Shoulder Stone Mobilization
- **Contract Item H1** is for DAYTIME Paving Mobilization
- **Contract Item H2** is for NIGHTTIME Paving Mobilization
- **Contract Item Q** is for Pavement Profiling Mobilization
- **Contract Item Z** is for Milled Rumble Strips Mobilization

Only one mobilization for paving per day of operation will be paid, unless moves of over five (5) miles between individual paving locations are required. In cases where a Vendor is required to move from one roadway to the adjacent roadway of a divided highway, additional mobilization for paving will only be paid if the nearest interchange or crossing point that will accommodate the Vendor's equipment is over five (5) miles from the paving locations.

3.3.24.1 Daytime Paving Mobilization, Contract Item H1, is a mobilization for paving charge which may be made when the Delivery Order quantity, per paving location, is less than 500 tons of Asphalt and nighttime paving is not requested.

3.3.24.2 Nighttime Paving Mobilization, Contract Item H2, is a mobilization for paving charge which may be made when the Delivery Order directs that the paving is to be done at night.

REQUEST FOR QUOTATION
Asphalt Materials, Delivery & Labor by Vendor by County

NOTE: This provision may require roundtrip moves of up to ten (10) miles with no additional mobilization for paving payment. An individual paving location shall be defined as a paving job where no skips exceeding 2,500 feet are involved, except between the approach slabs of a bridge or parallel pair of bridges.

3.3.25 Off-Season Plant Opening, Contract Item AD, is necessary if a Vendor is required to open their plant in the off-season to service the needs of the WVDOH, in which case an additional payment will be made. The Vendor will be paid an additional day charge for each additional consecutive day that the plant is open after the first day to service the needs of the WVDOH. If the plant produces no material for any use on any calendar day, either during the week or on the weekend, the WVDOH will pay the first day rate for off-season plant opening on the next day of the WVDOH usage. Payment for this item is subject to the following conditions:

3.3.25.1 Payment for this item can only be authorized and made during the winter months, i.e., between December 15th and March 15th, and then only if the plant would not have otherwise been open. These dates may be revised by the WVDOH District Engineer or their designee, if necessary, to meet specific needs in the field. Any such revision of dates will be in writing and shall be attached to the Vendor's invoice at the time payment is requested.

3.3.25.2 Payment will always be made at the full contract awarded bid price for the first day of plant opening; however, the amount paid from each additional day of plant opening will be reduced as follows:

A. Payment for additional day charge will not be made if the plant has produced over 500 tons on that day. If between 300 and 500 tons have been produced, payment for additional day charge will be made equal to one-half of the contract awarded bid price for the additional day charge. The quantity produced to make this determination shall include all material produced that day, which includes tonnage bought by the WVDOH, other local governments and all private work.

B. The WVDOH will only pay its share of the amount determined to be due for additional day charge as described above. For example, if the plant produces 375 tons and the

REQUEST FOR QUOTATION
Asphalt Materials, Delivery & Labor by Vendor by County

WVDOH takes 150 tons of the total, 40% of the plant's daily production, payment for additional day charge would be calculated as follows: Since the total daily production is between 300 and 500 tons, the Vendor is due 50% of the additional day charge. Because the WVDOH's share of this daily production is 40%, the WVDOH would pay 40% of one-half of the additional day charge, or in this case, 20% of the additional day charges.

3.3.25.3 A certified statement shall accompany the invoice stating the total quantity produced on the additional day. If payment does not qualify due to tonnage produced, the next consecutive day of plant operation, if any, will qualify for payment at the additional day rate rather than the first day rate for plant opening.

3.3.26 Vendor's Asphalt Plant Location: The Vendor shall provide on **Attachment C Asphalt Plant Information Form (ATT C)** the Vendor's Asphalt Plant Location which will be supply the materials listed on the **Attachment A Pricing Pages (ATT A)** spreadsheet. Reference Section 7.2.2 of these Contract Specifications.

3.3.27 Emergency Work: Emergency work as ordered by WVDOH District Engineer or their designee is work that shall be initiated within forty-eight (48) hours from when the Delivery Order is received by the vendor. The determination of emergency work will be in accordance with Section 2.5 of these Contract Specifications. Emergency Work must be prominently noted on Delivery Order. Designated emergency projects will be paid at 1.50 times the vendors bid price.

4. SAFETY

Pandemic-Response Safety Protocols: In addition to the Vendor's established safety protocols and the WVDOH's established safety protocols outline in the Standard Specs, as amended, the Vendor and the Vendor's staff shall adhere to all WVDOH's pandemic-response protocols while present at the WVDOH jobsite. Vendors may obtain the WVDOH's pandemic-response protocols by contacting the WVDOH District Engineer or their designee.

5. PRICE ADJUSTMENTS:

REQUEST FOR QUOTATION
Asphalt Materials, Delivery & Labor by Vendor by County

5.1 Price Adjustment of Asphalt Cement: Due to the uncertainty in estimating the cost of petroleum products that will be used during the life of this contract, adjustment in compensation for **Contract Items A, T and W** is provided for in the Standard Specs, as amended. Refer to the table below:

Contract Item	Description of Asphalt Section	AC (Average Asphalt Content)
A1	Section 401 – Base I	3.9
A2	Section 401 – 25mm Superpave	4.4
A3	Section 401 – Base II	5.0
A4	Section 401 – Patch and Level	5.0
A5	Section 401 – Wearing IV	5.2
A6	Section 402 – Wearing IV	5.1
A7	Section 401 – 19mm Superpave	4.7
A8	Section 401 – Scratch Course	6.2
A9	Section 402 – 9.5mm Superpave	6.1
A10	Section 401 – Wearing I	6.1
A11	Section 402 – Wearing I	6.0
A12	Section 401 – 4.75mm Superpave	7.6
A13	Section 402 – 4.75mm Superpave	7.2
A14	Section 401 – Wearing III	7.3
A15	Section 402 – Wearing III	7.5
A16	Section 401 - 12.5mm Superpave	5.6
A17	Section 402 - 12.5mm Superpave	5.6
T	Asphalt HPTO, SP496	7.1
W	Ultra-Thin Asphalt Overlay, SP498	7.6

5.2 Price Adjustment of Fuel Oil No. 2 (Diesel Fuel): Due to the uncertainty in estimating the cost of diesel fuel that will be used during the life of this contract, adjustment in compensation for **Contract Items A, T and W** is provided for in the Standard Specs, as amended.

The bidding index for Asphalt Binder will be listed on the Contract Administration website for Fuel, Asphalt and Cement Prices Adjustments listed for October 2021.

[https://transportation.wv.gov/highways/contractadmin/Lettings/Pages/FuelandAsphaltPrices.aspx#FuelPrices.](https://transportation.wv.gov/highways/contractadmin/Lettings/Pages/FuelandAsphaltPrices.aspx#FuelPrices)

6. ACCEPTANCE PLAN: Quality control at the plant and in-the-field shall be the responsibility of the Vendor and shall meet the requirements of MP 401.03.50. Compaction quality control shall be in accordance with MP 401.05.20. Acceptance testing shall be the responsibility of the WVDOH. Quality assurance of the material shall

REQUEST FOR QUOTATION
Asphalt Materials, Delivery & Labor by Vendor by County

be as set forth in MP 401.02.27 for Marshall Mix designs or MP 401.02.29 for Superpave mix designs. Referenced MP's, as amended, may be referenced at <https://transportation.wv.gov/highways/mcst/Pages/MP-400s.aspx>.

NOTE: Contrary to the Standard Specifications language, no price adjustment or bonus shall be made for compaction or smoothness under this contract. All other related Standard Specs requirements still apply.

7. CONTRACT AWARD:

7.1 Contract Award: The Contract is intended to provide Agencies with a purchase price on all Contract Items. All qualified responsible Vendors shall be awarded a contract for those Contract Items bid which meet all mandatory requirements of this Contract.

7.2 Pricing Pages and Plant Information Forms: A complete bid submission SHALL include multiple Attachments to include Pricing Pages AND corresponding Plant Information Forms.

- Vendor shall clearly identify the applicable counties on **Attachment A Pricing Pages (ATT A)** Pricing Page by marking an "X" beside applicable county/counties.
- Vendor shall clearly identify their bid, by county, on **Attachment B Mobilization Pricing Pages (ATT B)** by providing a lump sum price beside the applicable county/counties for each mobilization Contract Item they are bidding on, as listed in Section 3.3.23 of these Contract Specifications.
- Vendor shall list with each materials plant location which will provide the materials listed on the **Pricing Pages (ATT A)**, each plant location listing on **Attachment C Asphalt Plant Information Form (ATT C)** and **Attachment D Stone Plant Information Form (ATT D)** must also list the counties which the listed plant location serves.
- Vendor shall submit one complete set of Pricing Pages and Plant Information Forms for each county or grouping of counties with identical pricing. If bid prices differ across counties, the Vendor shall make duplicates of the Pricing Pages (ATT A and ATT B) and Plant Information Forms (ATT C and ATT D) and submit a new, separate, complete set of Pricing Pages and Plant Information Forms for each differing set of prices, identifying the applicable counties on each separate set.

REQUEST FOR QUOTATION
Asphalt Materials, Delivery & Labor by Vendor by County

NOTE: If the Vendor fails to provide the Asphalt (ATT C) or Stone (ATT D) Plant Location Information Form that corresponds with the Vendor's Pricing Pages (ATT A and ATT B), the Vendor's bid will be DISQUALIFIED for that bid submission.

7.2.1 Pricing Pages Spreadsheet: Vendor should complete the Pricing Pages spreadsheet by providing the following information for each Contract Item Bid:

- **Supplier Name - Vendor's Sourced Plant:** Vendor should identify the Vendor's sourced Plant name and this listing should correspond with Vendor's completed, mandatory Plant Information forms, **Attachment C Asphalt Plant Information Form (ATT C)** and **Attachment D Stone Plant Information Form (ATT D)**.
- **List Price:** Vendor shall list their bid per unit prices for each Contract Items they intend to bid. Vendor should not place formulas or any type of Excel calculations into the List Price column, only the actual bid price per Contract Item.

NOTE: Vendor shall not add to or modify any column headers, Contract Item descriptions, or units of measure on the Pricing Page spreadsheets. Any changes to the latter will result in disqualification of the Vendor's bid.

Submitting Pricing Pages or Attachments from a prior years' contract in lieu of the current Pricing Pages or Attachments included for this solicitation will result in the disqualification of the Vendor's bid.

The Pricing Pages spreadsheets list Contract Items with no guarantee that any Contract Item will be purchased throughout the life of this contract. Estimated quantities are not available.

Vendors may bid any or all Contract Items on the Pricing Pages spreadsheet. Bidding on any one Contract Item may not be conditioned on the acceptance of the bid on any other Contract Item(s).

7.2.2 Plant Information Forms: There are two (2) Plant Information Forms that must be submitted with corresponded Pricing Pages at the time of Bid: **Attachment C Asphalt Plant Information Form (ATT C)** identifies the Asphalt Plant and **Attachment D Stone Plant Information Form (ATT D)** identifies the Stone Plant for Shoulder Stone placement.

REQUEST FOR QUOTATION
Asphalt Materials, Delivery & Labor by Vendor by County

All Plant Information Forms shall be completed by Vendors and shall identify WVDOH Approved Plants, as amended, supplying materials associated with bid items on the Pricing Pages. A “COMPLETE” Plant Information Forms shall provide:

- Name of Vendor submitting the Plant Information Form as part of bid
- Plant Name
- Plant Location - 911 address or the most recent physical street address, city, and state
- Counties the listed Plant will supply the Vendor’s materials to

NOTE: If the Vendor fails to provide the Asphalt (ATT C) or Stone (ATT D) Plant Location Information Form that corresponds with the Vendor’s Pricing Pages (ATT A and ATT B), the Vendor’s bid will be DISQUALIFIED for that bid submission

7.2.3 Electronic Forms: Vendor should type or electronically enter the information into the Pricing Pages spreadsheet and the Plant Information Forms to prevent errors in the evaluation. In most cases, the Vendor can request an electronic copy of the Pricing Pages spreadsheets (ATT A & ATT B) and Plant Information Forms (ATT C & ATT D) for bid purposes by sending an email request to the following address:
Kristy.E.James@wv.gov.

7.3 Contract Award Transition: Upon the award of this contract, the WVDOH Operations Division will announce the effective date of use of this contract to the Districts and the Vendors, whether it is by the effective date, the completed and encumbered date, or an established date by the WVDOH. Upon the announced effective date of use, any Delivery Order issued prior to the award of the contract shall remain in effect and should not be cancelled until that Delivery Order is filled; however, after ten (10) working days of the Districts and Vendors notice, any Delivery Order that has not been completely filled by the Vendors shall NOT be completed, and a cancellation notice will be sent to that Vendor from the issuing District for cancellation of the balance of that Delivery Order only. No Delivery Orders from prior contracts should be held open by the Districts or the Vendors longer than ten (10) working days after the effective date of use is announced for the new contract.

This directive is issued to assist the Districts and the Vendors when fulfilling open Delivery Orders only. It is NOT issued to cause harm or to take contracts from

REQUEST FOR QUOTATION
Asphalt Materials, Delivery & Labor by Vendor by County

one Vendor to give to another Vendor, but to establish a transition process from one contract into another contract.

8. **DETERMINING LOW BID PER PROJECT:** To determine the low bid Vendor for individual repair paving projects, the WVDOH District Engineer or their designee will calculate the lowest overall total cost of the Contract Items required for individual projects. A written Delivery Order will be issued to the Vendor with the lowest overall total cost. Charges for hauling will be calculated according to Section 3.3.4 of these Contract Specifications.

WVDOH reserves the right to request any one or combination of items for which bids are awarded at the lowest overall total as set forth in this section.

9. **ORDERING AND PAYMENT:**

- 9.1 **Ordering:** Vendor shall accept orders through wvOASIS, regular mail, facsimile, email, or any other written forms of communication. Vendor shall maintain and keep current its phone numbers, fax number, email address, locations and ordering/billing/ payment addresses with WVDOH and in wvOASIS. Vendor may, but is not required to, accept online orders through a secure internet ordering portal/website. If Vendor has the ability to accept online orders, it should include in its response a brief description of how Agencies may utilize the online ordering system. Vendor shall ensure that its online ordering system is properly secured prior to processing Agency orders online.

- 9.2 **Delivery Order:** WVDOH will initiate the Delivery Order by identifying locations of need. The Delivery Order will be generated by a WVDOH Engineer or their designee. The order should be completed on a WV-39 Blanket Release Order. The order should detail the need and location information of the work to be completed per Contract Items, as well as the tentative start and end dates, to become the agreed upon official start and end dates. Emergencies shall be prominently noted on the Delivery Order. Once complete, the Delivery Orders shall be sent to Vendor via fax, email, or postal mail. Any verbal communications to initiate or make modifications to a project from this contract are not acceptable as a Delivery Order.

- 9.2.1 **Lead Time:** The WVDOH should plan accordingly to allow the Contractor a minimum of fourteen (14) calendar days prior to the date of the agreed upon work start date on the Delivery Order to allow Vendor to mobilize and begin work.

REQUEST FOR QUOTATION
Asphalt Materials, Delivery & Labor by Vendor by County

- 9.3 Payment:** Upon completion of the work indicated on the Delivery Order, Vendor shall accept payment in accordance with the payment procedures of the State of West Virginia. The State of West Virginia currently utilizes a Purchasing Card program, administered under contract by a banking institution, as well as Electronic Funds Transfer as methods to process payment for goods and services. The Vendor shall accept the State of West Virginia's Purchasing Card and Electronic Funds Transfer for payment of orders under this Contract. Electronic Funds Transfer for payment is available through the WV State Auditor's Office. The Vendor may visit the WV State Auditor's website (wvsao.gov) for all necessary forms and instructions. Payment method may be dictated at WVDOH's discretion.

10. PROJECT ACCEPTANCE, DELIVERY AND RETURN:

- 10.1 Project Acceptance and Written Verification of Receipt:** Upon receipt of a WVDOH Delivery Order, the Vendor shall advise the WVDOH in writing within five (5) calendar days of their acceptance or refusal of the Delivery Order. As verification of receipt, Vendor must provide written acknowledgement of any Delivery Orders and any Revisions/Modifications thereto sent by WVDOH. Failure to provide the WVDOH with written acknowledgement of any Delivery Orders/Revisions within five days of the Order being sent shall be considered refusal of the Delivery Order. In the event of refusal, the WVDOH at its own discretion shall cancel the Delivery Order and may seek to obtain the goods or services from the next low bid Vendor or proceed with an Emergency Purchase from the open market.
- 10.2 Negotiation of Dates:** The WVDOH shall have the option to negotiate with the Vendor, the project's tentative start and end dates. **Project work shall be continuous to completion unless otherwise approved in writing by the WVDOH District Engineer or their designee.**
- 10.3 Delivery Time:** The Vendor shall mobilize, commence, and complete work delivery in accordance with the WVDOH's written Delivery Order, per project. Any changes must be communicated by the Vendor in writing to the WVDOH District Engineer or their designee. The Vendor shall work in an efficient manner in effort to keep traffic delay to a minimum and traffic must be adequately and safely accommodated. Vendor shall ship/provide all orders in accordance with the dates assigned to each project per the Delivery Order and shall not hold orders until a minimum delivery quantity is met. **No Vendor is authorized to ship project related goods or begin work/services, nor is the WVDOH authorized to receive materials, prior to the issuance of a Delivery Order.**

REQUEST FOR QUOTATION
Asphalt Materials, Delivery & Labor by Vendor by County

10.4 Late Delivery: The Agency placing the order under this Contract must be notified in writing if orders will be delayed for any reason. Any delay in delivery that could cause harm to an Agency will be grounds for cancellation of the delayed order, and/or obtaining the items ordered from a third party. Agency placing the Delivery Order under this Contract must be notified **in writing by the Vendor no later than five (5) business days prior to the scheduled start date from the Agency's order.** Any failure to notify, acknowledge receipt of WVDOH's written Delivery Orders/ Revisions resulting in delivery delay, or failure to start or complete the project per the WVDOH scheduled due dates may be determined by the WVDOH at its sole discretion as harmful to the Agency and as such, shall result in WVDOH's cancellation of the Delivery Order and application of Liquidated Damages.

Any Agency seeking to obtain items from a third party under this provision must first obtain approval of the WVDOH Budget and Procurement Division.

10.4.1 Liquidated Damages: If the Vendor's work completion or corrections of deficient work exceeds the Delivery Order completion due date/timeframe, the Vendor shall agree that no extension of contract time will be granted unless Liquidated Damages are applied by the WVDOH in the form of an off-set reduction to the total amount of the Vendor's final invoice. The WVDOH shall calculate Liquidated Damages per project beginning on day one after the WVDOH's specified Delivery Order due date, in accordance with this Section, the contract's Terms and Conditions, and the Standard Specs Section 108.7, as amended.

10.5 Adverse Weather Conditions: Unsuitable/adverse/inclement weather conditions may dictate the work schedule. It is preferred that operations be suspended immediately when an inclement weather event begins or if the WVDOH District Engineer or their designee determines that an inclement weather event is imminent. If working conditions are dangerous or unsuitable for the WVDOH, Vendor, or general public, work shall be suspended by the WVDOH Engineer/designee. If needed, revision to the project's start and end date may be negotiated by the Vendor and the WVDOH Engineer/designee. After a weather-related suspension of work, the WVDOH District Engineer or their designee shall determine and convey in writing, such Delivery Order changes and when work shall commence/resume, followed by the Vendor's written acknowledgement, per Section 10.4 of this Contract Solicitation.

10.6 Delivery Payment/Risk of Loss: Standard order delivery shall be F.O.B. Vendor's Plant Location. **Haul by Vendor, Contract Item F**, shall be requested on the Delivery Order. Vendor shall include the cost/discount of standard order delivery charges in its bid pricing and is not permitted to charge the Agency

REQUEST FOR QUOTATION
Asphalt Materials, Delivery & Labor by Vendor by County

separately for such delivery.

- 10.7 Project Acceptance Criteria:** The WVDOH District Engineer or their designee shall have final acceptance of the work done by the Vendor, per project. Any work found by the WVDOH District Engineer or their designee not performed in accordance with these contract Specifications and the Standard Specs, as amended, and/or found deficient and unacceptable by visual inspection will be rejected and, at the Vendor's/Contractor's expense, will be removed and replaced by the Vendor with work being continual until the Vendor's deficient work corrections are completed and deemed acceptable and approved by the WVDOH District Engineer or their designee. Under no circumstance shall the Vendor's deficiency corrections exceed twenty (20) calendar days unless otherwise declared in writing by the WVDOH District Engineer or their designee, subject to Liquidated Damages as per Section 10.4.1 of these Contract Specifications.
- 10.8 Rejection of Unacceptable Contract Items:** The decision of the WVDOH District Engineer or their designee regarding materials, workmanship, quality etc., shall be final per the Standard Specs **Section 105**, as amended.

11. VENDOR DEFAULT:

- 11.1** The following shall be considered a vendor default under this Contract.
- 11.1.1** Failure to provide Contract Items in accordance with the requirements contained herein.
 - 11.1.2** Failure to comply with other specifications and requirements contained herein.
 - 11.1.3** Failure to comply with any laws, rules, and ordinances applicable to the Contract Services provided under this Contract.
 - 11.1.4** Failure to remedy deficient performance upon request.
- 11.2** The following remedies shall be available to Agency upon default.
- 11.2.1** Immediate cancellation of the Contract.
 - 11.2.2** Immediate cancellation of one or more release orders issued under this Contract.

REQUEST FOR QUOTATION
Asphalt Materials, Delivery & Labor by Vendor by County

11.2.3 Any other remedies available in law or equity.

12. MISCELLANEOUS:

- 12.1 No Substitutions:** Vendor shall supply only Contract Items submitted in response to the Solicitation unless a contract modification is approved in accordance with the provisions contained in this Contract.
- 12.2 Vendor Supply:** Vendor must carry sufficient inventory of the Contract Items being offered to fulfill its obligations under this Contract. By signing its bid, Vendor certifies that it can supply the Contract Items contained in its bid response.
- 12.3 Vendor's Invoices:** Invoices for materials, **Contract Items A, S, V, and T**, must be submitted separately from all other items. All other items shall be submitted on a separate invoice. The Vendor's invoices must be submitted as an original containing the following information:
- All weigh ticket numbers for material delivered and cuttings hauled during the invoice period.
 - WVDOH Delivery Order number and this contract number.
 - Total quantity and unit price with the total cost of each type of material furnished.
 - No payment will be made to a Contractor for **Daytime Paving Mobilization, Contract Item H1**, unless the quantity is less than 500 tons or **Nighttime Paving Mobilization, Contract Item H2** unless the Delivery Order directs that the paving is to be done at night.
- 12.4 Reports:** Vendor shall provide the Agency with quarterly reports, annual summaries, and/or monthly reports as requested by the Agency and/or the West Virginia Purchasing Division showing quantities, total dollar value of the Contract Items purchased, ordered, shipped & invoiced with dates in spreadsheet format as defined by the Agency. Failure to supply such reports may be grounds for cancellation of this Contract.

REQUEST FOR QUOTATION
Asphalt Materials, Delivery & Labor by Vendor by County

12.5 Contract Manager: During its performance of this Contract, Vendor must designate and maintain a primary contract manager responsible for overseeing Vendor's responsibilities under this Contract. The Contract Manager must be available during normal business hours to address any customer service or other issues related to this Contract. Vendor should list its Contract Manager and his or her contact information below.

Contract Manager: Rick Johnson
Telephone Number: 304-768-9733 Ext. 6404
Fax Number: 304-768-9351
Email Address: rjohnson@wvpaving.com

Vendor shall inform the Agency in writing of any changes to the information provided above within ten (10) calendar days of such changes. Failure to comply may be grounds for cancellation of this contract.

Exhibit 1 - Shoulder Reconstruction Detail

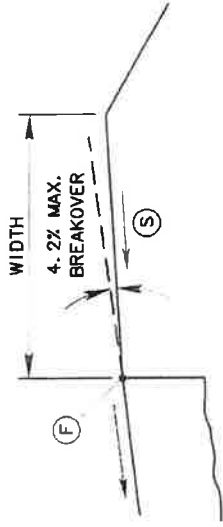
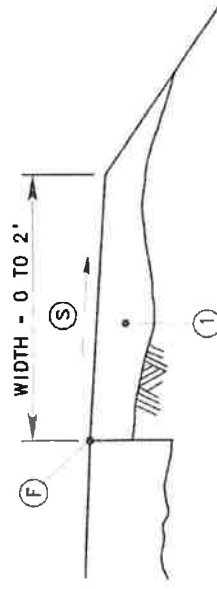
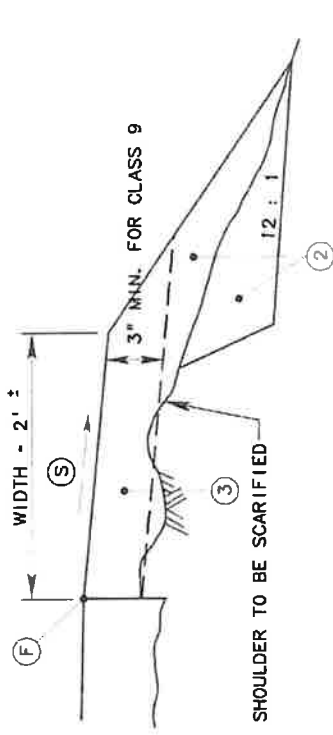
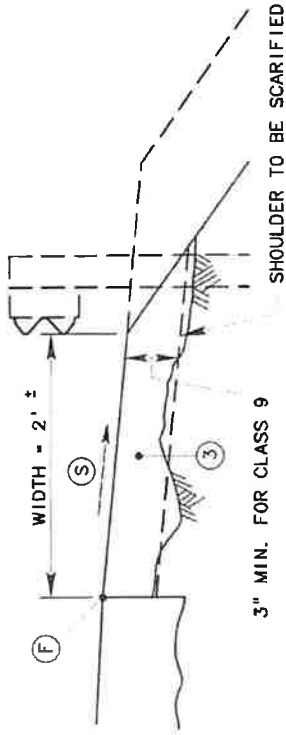

LEGEND

- ① ITEM 401001- , HOT-MIX ASHALT BASE COURSE, TYPE
- ② ITEM 211008-000, ROCK BORROW EXCAVATION
The intent of this item is to provide proper foundation for the shoulder while restoring the original shoulder width reduced by erosion. Additional material, as directed by the Engineer, may be required by recent erosion and will be paid for as 211008-000. Excavation of benches for placing, 211008-000 will be included in 211008-000.
- ③ ITEM 307005-001, AGGREGATE BASE COURSE, CLASS 10
This item includes any necessary removal of existing shoulder material to a minimum of 3" below the finished pavement elevation when Class 9 aggregate is specified. Material removed shall be reused within the project limits or wasted as directed by the Engineer. Scarifying shall be in accordance with Section 308.3.1 of the Specifications.
- ④ FINISHED PAVEMENT ELEVATION
- ⑤ SHOULDER SLOPE
Normal Sections : 6 %.
Super-elevated : Match rate of super-elevation or reduce as shown above
Minimum slope to be 3/4" per foot, on low side of super-elevation.
Paved Shoulders : 4 % or super-elevated.

THE WEST VIRGINIA DEPARTMENT OF TRANSPORTATION DIVISION OF HIGHWAYS

SHOULDER RECONSTRUCTION

Public Roads Div.	State Dist. No.	State Project No.	Federal Project No.	County
W. V.				

Exhibit 2 - Restoring Shoulder for Guardrail Detail

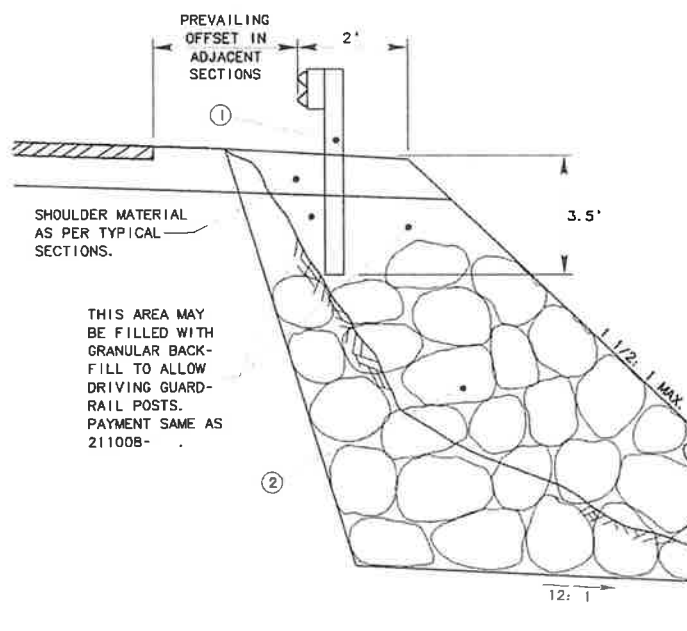

The intent of this construction is to restore, in limited areas, the shoulder width sufficiently to allow placing guardrail at an offset nearly equal to that prevailing in adjacent sections avoiding situations where posts would not provide proper strength. In areas where such construction is not practical, special designs such as piling will be used if specified in the plans.

All necessary excavation of the fill bench will be incidental to the cost of items 21100B-000, and no separate payment will be made.

The dimensions of the Rock Borrow shall be, based on visual inspection, 20% not less than 1.5 cu. ft., 50% not less than 1.0 cu. ft. and 30% not less than 0.5 cu. ft. Adequate rock fragments shall be included to fill the rock voids.

- ① ITEM 607001-001, TYPE I GUARDRAIL, CLASS (AS SHOWN ON PLANS)
- ② ITEM 21100B-000, ROCK BORROW EXCAVATION

THE WEST VIRGINIA DEPARTMENT OF TRANSPORTATION DIVISION OF HIGHWAYS

RESTORING SHOULDERS FOR GUARDRAIL

Public Road Dist.	State Dist. No.	State Project No.	Federal Project No.	County
W. V.				

**WEST VIRGINIA DEPARTMENT OF TRANSPORTATION
DIVISION OF HIGHWAYS
DESIGN DIRECTIVE**

DD-650
PAVEMENT SAFETY EDGE
January 10, 2012

This Design Directive provides all designers with the West Virginia Department of Transportation (WVDOT), Division of Highways' (DOH) policy for providing a "safety edge" on all pavements meeting the required criteria.

10. General

Roadway Departure, in which a vehicle unintentionally departs its lane and either runs off the roadway, crosses the centerline or median, goes airborne, or hits a fixed object is the leading cause of fatalities on West Virginia roadways. Approximately 70% of all roadway fatalities are attributed to roadway departure in West Virginia.

Pavement edge drop-offs are a recurring problem between the pavement and the graded material that makes up the shoulder or roadside. Paved shoulders increase the chance of recovery but do not reduce the occurrence of drop offs from the shoulder to the roadside. Research has shown that even small drop-offs can create problems for drivers attempting to recover.

The Safety Edge is a simple, low cost technique that can make an edge drop-off significantly safer. The safety edge provides the driver with greater ease in returning the vehicle to the roadway, and reduction of the risk of over-steering and possible loss of control of the vehicle. With the safety edge in place, any interference in driving across any drop-off between the pavement edge and shoulder is mitigated by the slope of the safety edge, preventing tire “scrubbing” and thus providing errant drivers more opportunity to regain control of their vehicle and either avoid or lessen the severity of a crash.

20. Criteria for Use

The safety edge will be required on all NHS highway routes, and all routes designated “arterial” and “collector” in accordance with DD-601. It is to be used on both asphalt and concrete pavements unless the roadway or shoulder is curbed or is bounded by a barrier such as a single-slope barrier (usually in the median of 6-lane (or more) expressways and Interstate highways, but can be at the edge of the shoulder in certain applications). The Safety Edge is recommended for all other designated roadways in accordance with DD-601.

On overlay projects, Safety Edge is recommended if the total overlay thickness (scratch excluded) is 1.5” or greater. Safety Edge will not be placed if total overlay thickness is less than 1.5”. In addition, if overlay project involves milling and replacing in kind on mainline only (commonly referred to as “mill and fill” projects), then Safety Edge will not be utilized.

30. Design and Plan Requirements

The angle of the bevel from the slope of the pavement is critical for the safety edge to function properly. Measured from the cross slope of the pavement, the required angle ranges from 30 to 35 degrees.

For pavements with safety edge, shoulder aggregate shall be placed and maintained to the top of the pavement elevation.

In areas where the shoulder is soft and cannot be compacted, or for other reasons it cannot provide support for the safety edge, widening of the pavement shall be provided to support the edge. Field investigations should be made to check for any condition that will not support the safety edge. However if this condition exists at locations where the shoulder is non-existent and the edge of pavement is at the top of a roadside ditchline, the outside point of the safety edge (the toe) should be placed at the original edge of pavement, with the edge stripe at the safety edge's breakpoint. The designer must use sound engineering judgment when resurfacing existing roadways regarding the location of the new edge of pavement, placement of the safety edge, and any pavement widening.

When safety edge is required, it will be detailed on the typical sections. If there are any areas where the edge is not required or cannot be placed, limiting stations will also be given.

The following sketches are not to scale and represent a schematic detail for the purpose of showing configurations and dimensions only. Also, the free-draining base course trench may not be located as shown in these sketches.

A. Asphalt Pavement and Overlays

For projects bid in Tons (Megagrams) the asphalt quantity will be the actual quantity computed, including the safety edge. Note that the safety edge can be constructed on each lift of asphalt.

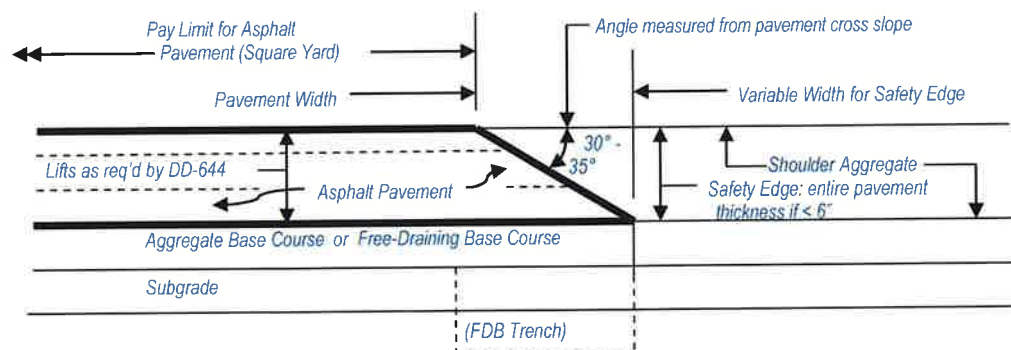

Safety Edge Dimensions for Asphalt Pavement (New Construction < 6" thickness)

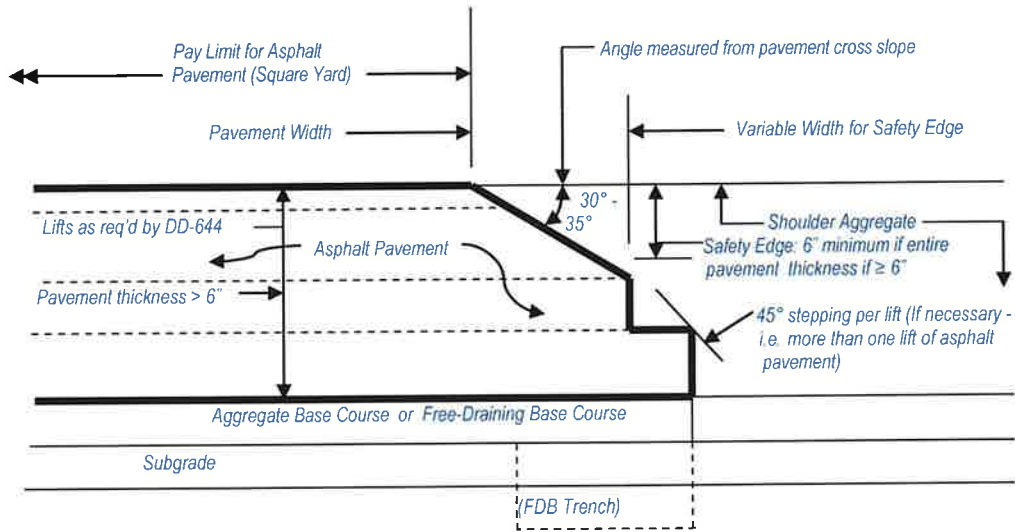

Safety Edge Dimensions for Asphalt Pavement (New Construction ≥ 6 " thickness)

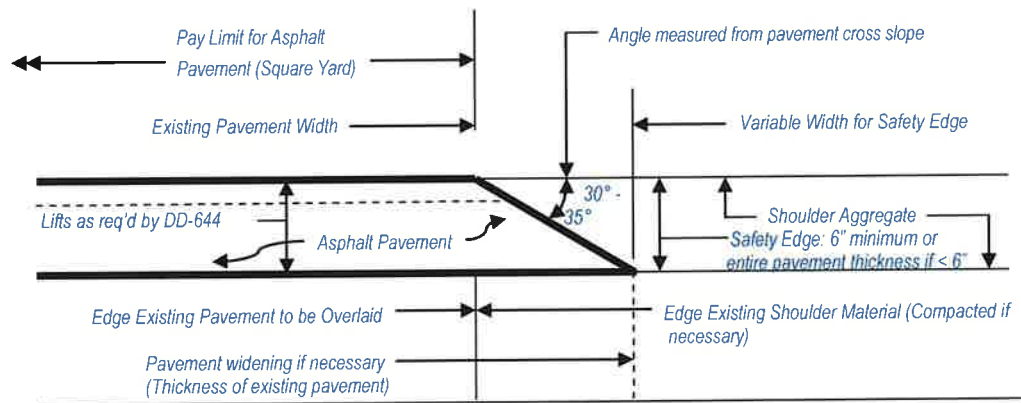

Safety Edge Dimensions for Asphalt Pavement (Overlay – for Roadways with Established Design Criteria, i.e. Interstate, APD, NHS and US Routes)

B. Concrete Pavement and Overlays

The sloped portion of the safety edge is to be 6" minimum in vertical height. To allow proper finishing by a slip-form paver, a minimum 2" vertical face is required at the bottom outside of the safety edge.

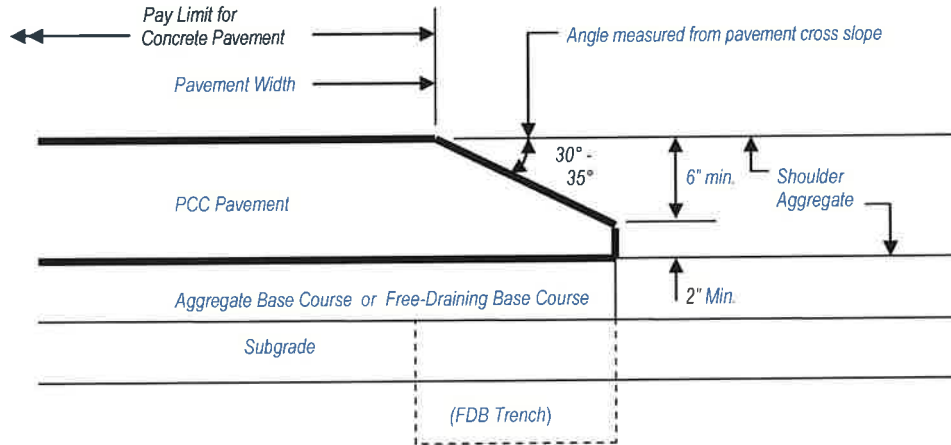

Safety Edge Dimensions for Concrete Pavement (New Construction)

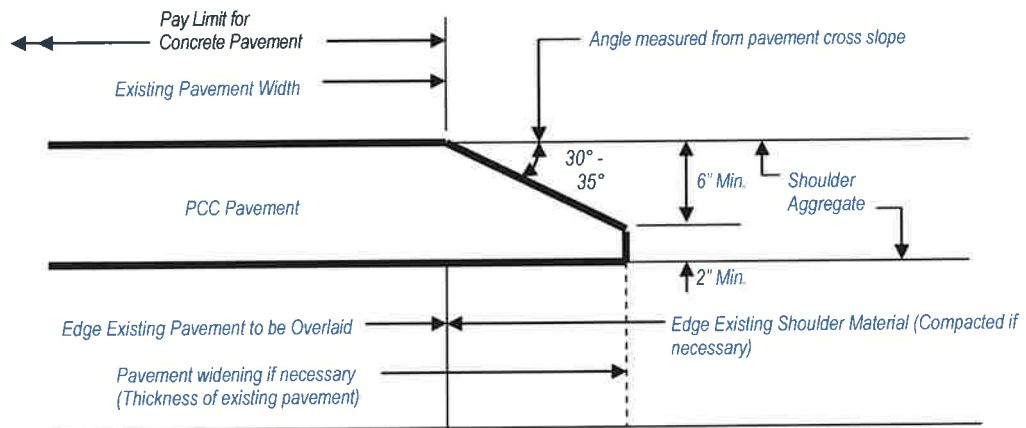

Safety Edge Dimensions for Concrete Pavement Overlay – for Roadways with Established Design Criteria, i.e. Interstate, APD, NHS and US Routes)

Exhibit 4 - Repaving Pipe Trenches in Paved Shoulder Detail

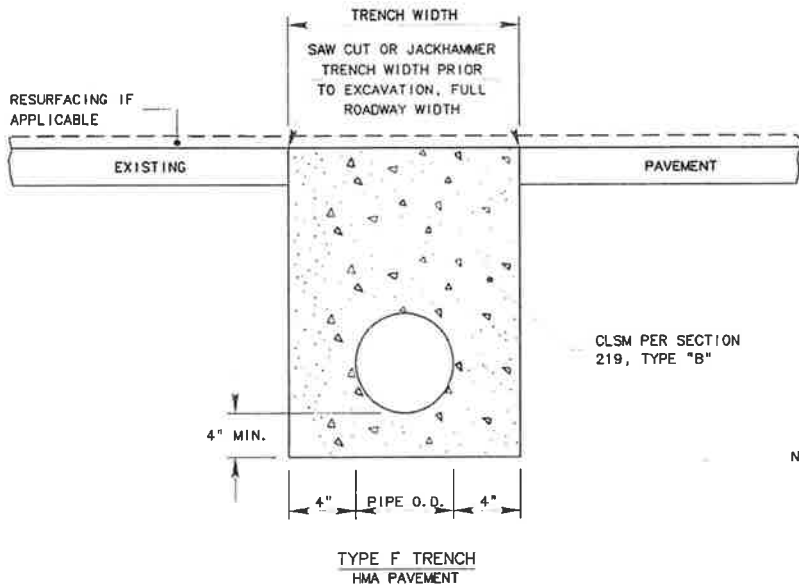

CLSM PER SECTION 219, TYPE "B"

WHEN NO OVERLAY IS SPECIFIED THE CONTROLLED LOW-STRENGTH MATERIAL (CLSM) SHALL BE A MIN. OF 2000 psi FOR DOH PIPES ONLY. NOT TO BE USED FOR UTILITY PIPES.

NOTE: IF TYPE F TRENCH IS USED WHERE THERE IS NO EXISTING OR PROPOSED INLET, THE CLSM SHALL BE POURED FULL DEPTH 2' PAST EACH E.P. THE PIPE SHALL BE ENCASED IN 4" OF CLSM AN ADDITIONAL 10' MAX. BEYOND E.P. IF THERE IS AN EXISTING OR PROPOSED INLET THE CLSM SHALL BE POURED FULL DEPTH TO THE INLET.

THE WEST VIRGINIA DEPARTMENT OF TRANSPORTATION DIVISION OF HIGHWAYS

REPAVING PIPE TRENCHES IN PAVED SHOULDER

Public Roads Div.	State Dist. No.	State Project No.	Federal Project No.	County
W. V.				

Exhibit 5 - Resurfacing Heel-In Detail

TEMPORARY WEDGES AT HEEL-INS

THE CONTRACTOR MAY ELECT TO CUT THE REQUIRED HEEL-INS SUCH THAT TRAFFIC MUST BE MAINTAINED OVER THE HEEL-IN AREAS PRIOR TO THE PLACEMENT OF THE PERMANENT HMA MATERIAL. IF THE CONTRACTOR CHOOSES THIS METHOD AS AN ALTERNATE TO CUTTING THE HEEL-INS AND BACKFILLING WITH PERMANENT HMA PRIOR TO RESTORING TRAFFIC. IT SHALL BE THE CONTRACTORS RESPONSIBILITY TO PLACE TEMPORARY HMA WEDGES 10 FEET IN LENGTH FOR EACH 1 INCH OF EXISTING SURFACE REMOVED AT THE VERTICAL FACE. FOR EXAMPLE, IF 2 INCHES ARE REMOVED AT THE VERTICAL FACE, THE TEMPORARY HMA WEDGE SHALL BE 20 FEET IN LENGTH. THE WEDGES SHALL BE CONSTRUCTED OF ITEM 401001-011, TYPE 19, PLACED AND COMPACTED IN ACCORDANCE WITH SECTION 401.14. THESE TEMPORARY WEDGES SHALL BE REMOVED IMMEDIATELY PRIOR TO PLACING THE PERMANENT SURFACE. THE COST OF THIS WORK WILL BE INCLUDED IN VARIOUS PAVEMENT ITEMS.

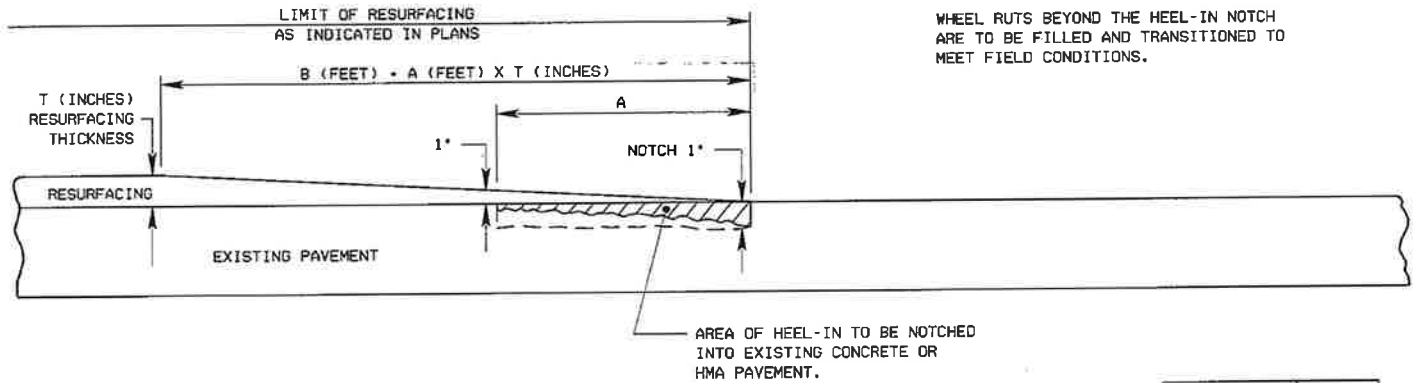

WHEEL RUTS BEYOND THE HEEL-IN NOTCH ARE TO BE FILLED AND TRANSITIONED TO MEET FIELD CONDITIONS.

AREA OF HEEL-IN TO BE NOTCHED INTO EXISTING CONCRETE OR HMA PAVEMENT.

POSTED SPEED LIMIT	A
25 MPH	12'
30 TO 35 MPH	14'
40 TO 45 MPH	16'
50 TO 55 MPH	18'
60 TO 70 MPH	25'

1. PAYMENT FOR HEEL-IN TO BE INCLUDED IN VARIOUS PAY ITEMS OF THIS PROJECT
2. THIS DETAIL TO BE USED AT TERMINI OF RESURFACING PROJECTS AND AT ALL TERMINI FOR SKIP RESURFACING PROJECTS.
3. THIS DETAIL TO BE USED AT LOCATIONS FOR HEEL-IN INTERSECTIONS OF THIS PROJECT.
4. THE FOLLOWING NUMBER(S) OF HEEL-INS FOR THE MAINLINE ON THIS PROJECT SHALL BE:
 PERPENDICULAR
 SKEWED AT

THE WEST VIRGINIA DEPARTMENT OF TRANSPORTATION DIVISION OF HIGHWAYS

RESURFACING HEEL-IN DETAIL

PUBLIC ROADS DIV.	STATE DIST. NO.	STATE PROJECT NO.	FEDERAL PROJECT NO.	COUNTY
W. V.				

Exhibit 6 - Base Failure Repair Detail

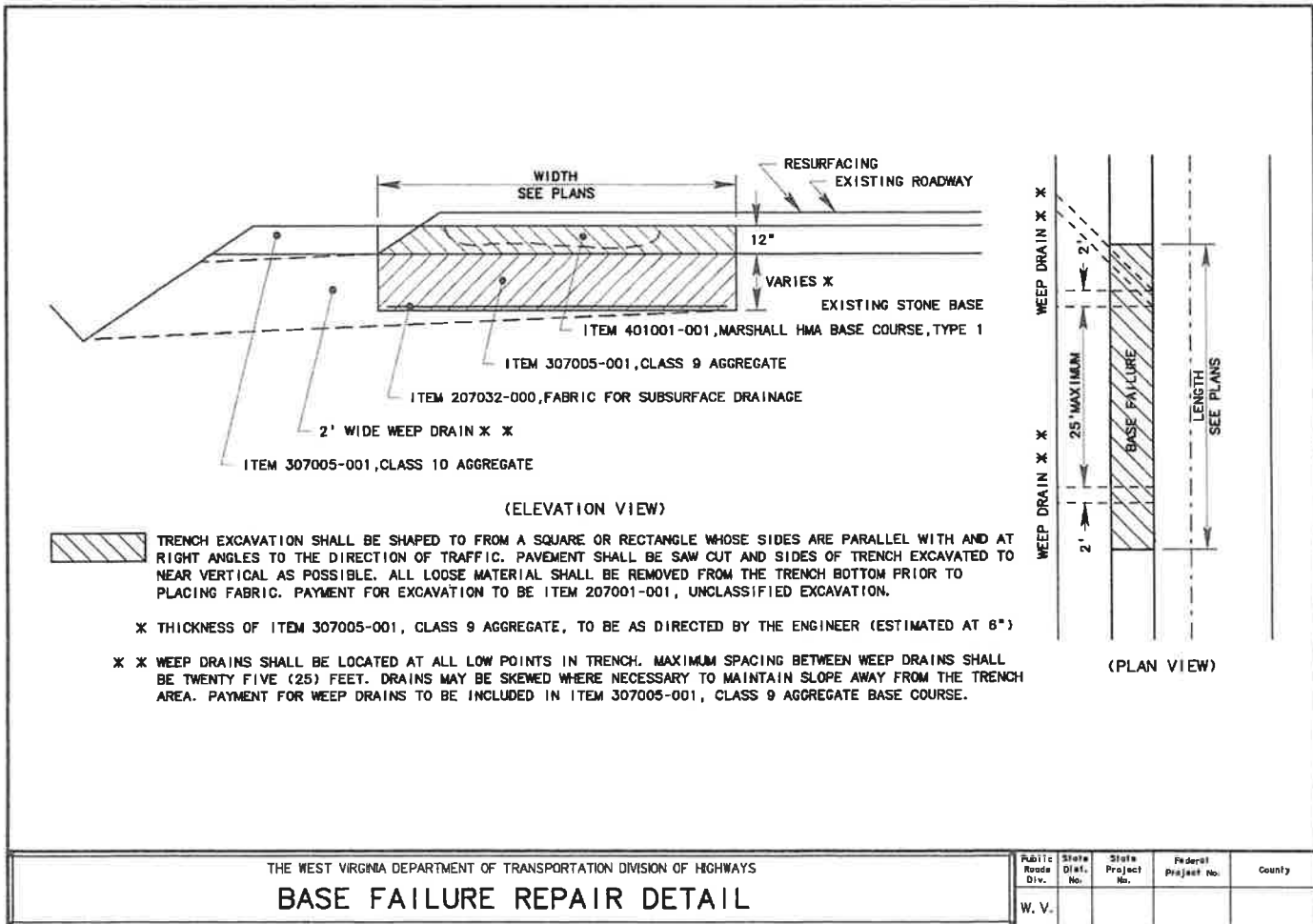

Exhibit 7 - Edge Failure Repair Detail

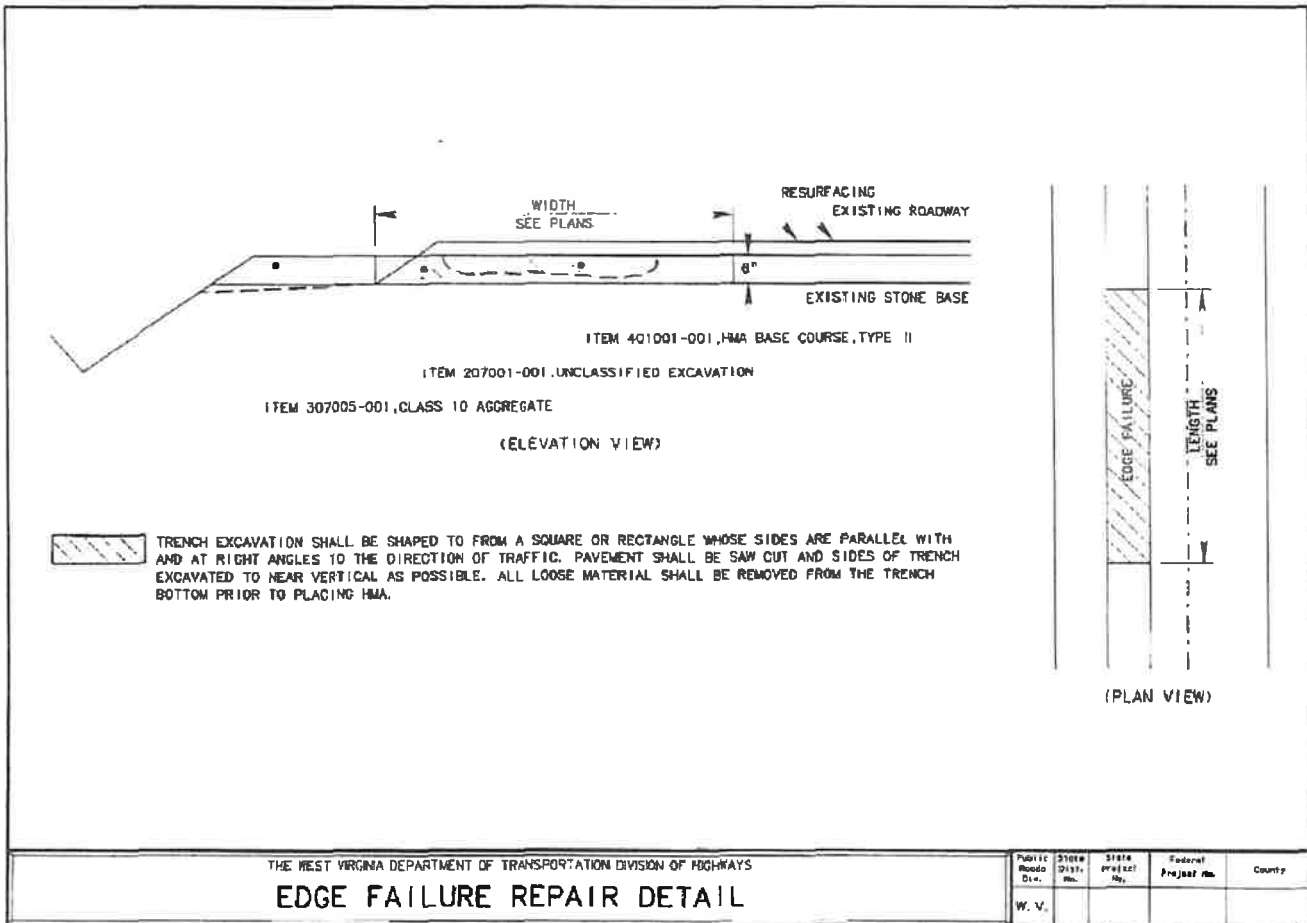
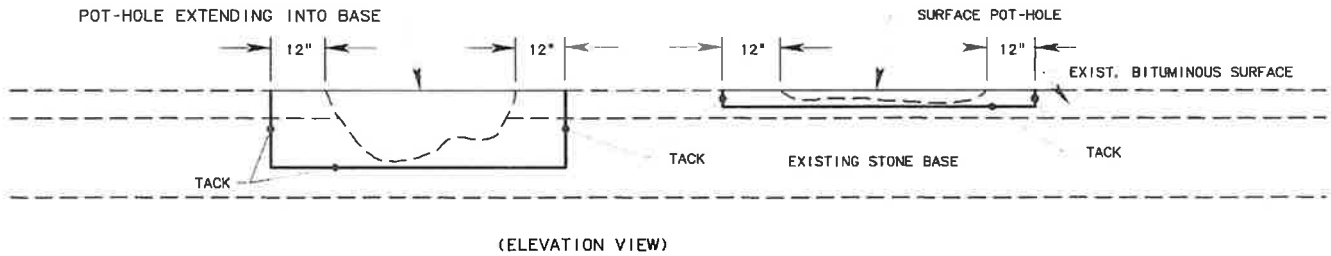

Exhibit 8 - Pothole Repair Detail



THE SIDES AND BOTTOMS MUST BE CLEANED AFTER THE HOLE IS SHAPED TO FROM A SQUARE OR RECTANGLE WHOSE SIDES ARE PARALLEL OR AT RIGHT ANGLES TO THE DIRECTION OF TRAFFIC WITH THE EDGES NEAT AND AS NEARLY VERTICAL AS POSSIBLE.

THE EXISTING BASE WILL BE REPLACED WITH HOT-LAID ASPHALT.

THE REMAINING SURFACE POT-HOLE WILL BE FILLED WITH HOT-LAID ASPHALT BASE COURSE TYPE MEETING REQUIREMENTS OF SECTION 401 OF THE SPECS. ENOUGH MATERIAL MUST BE USED TO BRING THE SURFACE OF REPAIR ABOUT 1/8" ABOVE THE LEVEL OF THE ORIGINAL PAVEMENT TO ALLOW FOR FURTHER COMPACTION BY TRAFFIC AND/OR RESURFACING.

THE WEST VIRGINIA DEPARTMENT OF TRANSPORTATION DIVISION OF HIGHWAYS

POT - HOLE REPAIR DETAIL

Public Roads Div.	State Dist. No.	State Project No.	Federal Project No.	County
W. V.				

Exhibit 9 - Rumble Strip Special Detail

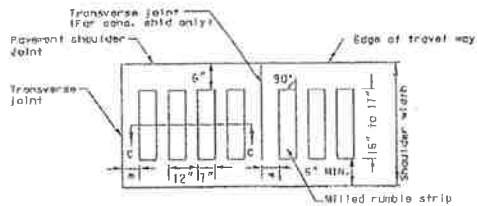
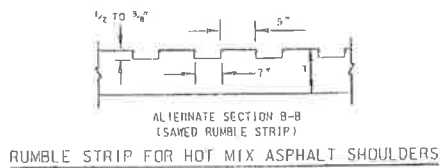

* $7\frac{1}{2}$ " For conc. shld.
 $2\frac{1}{2}$ " For asphalt shld.

MILLED RUMBLE STRIP FOR PORTLAND CEMENT AND HOT MIX ASPHALT SHOULDERS

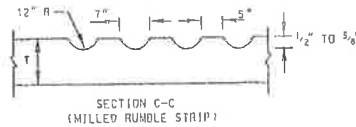

NOTES:

RUMBLE STRIP PLACEMENT WILL BE CONTINUOUS ON HOT-MIX ASPHALT SHOULDERS, EXCEPT AS NOTED BELOW.

RUMBLE STRIPS SHALL NOT BE PLACED AT THE FOLLOWING AREAS FOR INTERURBAN PROJECTS, ONLY:
 ON SPURWAYS OF HIGHWAY CLASSIFICATION THAT ARE 5' OR LESS IN WIDTH FROM TRAFFIC FLOW IN THE SHOULDER TRANSITION AREA FROM TRAFFIC FLOW, BETWEEN A FULL PAVED SHOULDER WIDTH OF 10' AND HIGHWAY BRIDGE WIDTH OF 4';
 RUMBLE STRIP WIDTH IS TO BE 2', EXCEPT MILLED RUMBLE STRIP WHICH WILL BE 10'-17'.

RUMBLE STRIPS MAY BE SAWS OR MILLED UNLESS OTHERWISE SPECIFIED. THE TOP OF THE RUMBLE STRIPS WILL BE NO HIGHER THAN THE TOP SURFACE OF THE PAVEMENT. ANY FAULTY OR IMPROPERLY INSTALLED RUMBLE STRIPS WILL BE CORRECTED BY THE CONTRACTOR AT HIS EXPENSE.

MILL/SAW SHOULDER RUMBLE STRIPS AS SPECIFIED BY USING A MILLING MACHINE OR FINISHING A SMOOTH CUT SURFACE LEAVING ON SHOULDERS AND PORTLAND RUMBLE STRIPS AS SPECIFIED EQUIP. MACHINE WITH CARES TO FINISH UNIFORMLY AND PERPENDICULAR TO A CENTER OF EACH CUT WITH RESPECT TO HIGHWAY AND SHOULDER RUMBLE STRIPS TO HAVE FRESH UNCONSOLIDATED MATERIAL TO FINISH SPECIFIED. ALL SHOULDER RUMBLE STRIPS ON NEW CONCRETE SHOULDERS AFTER CURING PERIODS OF PATTERN EDGE WILL BE RASPED & VERIFIED AND CHECKED IMMEDIATELY BEFORE OPERATION. IF SATISFACTORY RESULTS ARE NOT BEING OBTAINED AND SHOWS AN ALTERNATE CONSTRUCTION PLAN TO THE ENGINEER FOR APPROVAL. AT END OF EACH WORKING DAY, MOVE ALL EQUIPMENT TO A LOCATION AS DIRECTED THERE. IT IS ESSENTIAL TO ROADWAY TRAFFIC RESUME AND DISPOSE OF MILLED MATERIAL IN COMPLIANCE WITH APPROPRIATE STATE REQUIREMENTS REMOVE DEBRIS FROM AREAS WITHIN 24 HOURS OF OPERATION BEFORE OPENING HIGHWAY TO TRAFFIC.

RUMBLE STRIPS ON PAVED SHOULDERS:

RUMBLE STRIPS SHALL BE MILLED OR SAWS TYPE PLACED IN SHOULDERS UNDER THE FOLLOWING CONDITIONS IN ACCORDANCE WITH THIS SPECIAL DETAIL SHEET:

- TYPICAL SHOULDER WIDTH IS 10' OR GREATER
- SHOULDER ALIGNED TO ONE WAY RAMP WHICH CORRECT TO ADJACENT ROADWAYS, & TYPICAL SHOULDER IS 3' OR GREATER.

THE WEST VIRGINIA DEPARTMENT OF TRANSPORTATION DIVISION OF HIGHWAYS

RUMBLE STRIP SPECIAL DETAIL

West Virginia Ethics Commission



Disclosure of Interested Parties to Contracts

Pursuant to *W. Va. Code* § 6D-1-2, a state agency may not enter into a contract, or a series of related contracts, that has/have an actual or estimated value of \$1 million or more until the business entity submits to the contracting state agency a Disclosure of Interested Parties to the applicable contract. In addition, the business entity awarded a contract is obligated to submit a supplemental Disclosure of Interested Parties reflecting any new or differing interested parties to the contract within 30 days following the completion or termination of the applicable contract.

For purposes of complying with these requirements, the following definitions apply:

"Business entity" means any entity recognized by law through which business is conducted, including a sole proprietorship, partnership or corporation, but does not include publicly traded companies listed on a national or international stock exchange.

"Interested party" or *"Interested parties"* means:

- (1) A business entity performing work or service pursuant to, or in furtherance of, the applicable contract, including specifically sub-contractors;
- (2) the person(s) who have an ownership interest equal to or greater than 25% in the business entity performing work or service pursuant to, or in furtherance of, the applicable contract. (This subdivision does not apply to a publicly traded company); and
- (3) the person or business entity, if any, that served as a compensated broker or intermediary to actively facilitate the applicable contract or negotiated the terms of the applicable contract with the state agency. (This subdivision does not apply to persons or business entities performing legal services related to the negotiation or drafting of the applicable contract.)

"State agency" means a board, commission, office, department or other agency in the executive, judicial or legislative branch of state government, including publicly funded institutions of higher education: Provided, that for purposes of *W. Va. Code* § 6D-1-2, the West Virginia Investment Management Board shall not be deemed a state agency nor subject to the requirements of that provision.

The contracting business entity must complete this form and submit it to the contracting state agency prior to contract award and to complete another form within 30 days of contract completion or termination.

This form was created by the State of West Virginia Ethics Commission, 210 Brooks Street, Suite 300, Charleston, WV 25301-1804. Telephone: (304)558-0664; fax: (304)558-2169; e-mail: ethics@wv.gov; website: www.ethics.wv.gov.

West Virginia Ethics Commission
Disclosure of Interested Parties to Contracts

(Required by W. Va. Code § 6D-1-2)

Name of Contracting Business Entity: West Virginia Paving, Inc. Address: 2950 Charles Ave.

Dunbar, WV 25064

Name of Authorized Agent: Robert Brookover Address: 29650 Charles Ave
Dunbar WV 25064

Asphalt Materials, Delivery & Labor by Vendor
by County

Contract Number: ARFQ 0803 DOT2200000014 Contract Description: Asphalt Materials, Delivery & Labor by Vendor
by County

Governmental agency awarding contract: West Virginia Division of Highways

Check here if this is a Supplemental Disclosure

List the Names of Interested Parties to the contract which are known or reasonably anticipated by the contracting business entity for each category below (attach additional pages if necessary):

1. Subcontractors or other entities performing work or service under the Contract

Check here if none, otherwise list entity/individual names below.

2. Any person or entity who owns 25% or more of contracting entity (not applicable to publicly traded entities)

Check here if none, otherwise list entity/individual names below.

3. Any person or entity that facilitated, or negotiated the terms of, the applicable contract (excluding legal services related to the negotiation or drafting of the applicable contract)

Check here if none, otherwise list entity/individual names below.

Signature: Robert Brookover



Date Signed: November 30, 2021

Notary Verification

State of West Virginia, County of Kanawha:

I, Robert Brookover, the authorized agent of the contracting business entity listed above, being duly sworn, acknowledge that the Disclosure herein is being made under oath and under the penalty of perjury.

Taken, sworn to and subscribed before me this 30 day of November, 2021.

Victoria W. McGrew
Notary Public's Signature

To be completed by State Agency:

Date Received by State Agency: _____

Date submitted to Ethics Commission: _____

Governmental agency submitting Disclosure: _____



STATE OF WEST VIRGINIA
Purchasing Division

PURCHASING AFFIDAVIT

CONSTRUCTION CONTRACTS: Under W. Va. Code § 5-22-1(i), the contracting public entity shall not award a construction contract to any bidder that is known to be in default on any monetary obligation owed to the state or a political subdivision of the state, including, but not limited to, obligations related to payroll taxes, property taxes, sales and use taxes, fire service fees, or other fines or fees.

ALL CONTRACTS: Under W. Va. Code §5A-3-10a, no contract or renewal of any contract may be awarded by the state or any of its political subdivisions to any vendor or prospective vendor when the vendor or prospective vendor or a related party to the vendor or prospective vendor is a debtor and: (1) the debt owed is an amount greater than one thousand dollars in the aggregate; or (2) the debtor is in employer default.

EXCEPTION: The prohibition listed above does not apply where a vendor has contested any tax administered pursuant to chapter eleven of the W. Va. Code, workers' compensation premium, permit fee or environmental fee or assessment and the matter has not become final or where the vendor has entered into a payment plan or agreement and the vendor is not in default of any of the provisions of such plan or agreement.

DEFINITIONS:

"Debt" means any assessment, premium, penalty, fine, tax or other amount of money owed to the state or any of its political subdivisions because of a judgment, fine, permit violation, license assessment, defaulted workers' compensation premium, penalty or other assessment presently delinquent or due and required to be paid to the state or any of its political subdivisions, including any interest or additional penalties accrued thereon.

"Employer default" means having an outstanding balance or liability to the old fund or to the uninsured employers' fund or being in policy default, as defined in W. Va. Code § 23-2c-2, failure to maintain mandatory workers' compensation coverage, or failure to fully meet its obligations as a workers' compensation self-insured employer. An employer is not in employer default if it has entered into a repayment agreement with the Insurance Commissioner and remains in compliance with the obligations under the repayment agreement.

"Related party" means a party, whether an individual, corporation, partnership, association, limited liability company or any other form or business association or other entity whatsoever, related to any vendor by blood, marriage, ownership or contract through which the party has a relationship of ownership or other interest with the vendor so that the party will actually or by effect receive or control a portion of the benefit, profit or other consideration from performance of a vendor contract with the party receiving an amount that meets or exceeds five percent of the total contract amount.

AFFIRMATION: By signing this form, the vendor's authorized signer affirms and acknowledges under penalty of law for false swearing (W. Va. Code §61-5-3) that: (1) for construction contracts, the vendor is not in default on any monetary obligation owed to the state or a political subdivision of the state, and (2) for all other contracts, that neither vendor nor any related party owe a debt as defined above and that neither vendor nor any related party are in employer default as defined above, unless the debt or employer default is permitted under the exception above.

WITNESS THE FOLLOWING SIGNATURE:

Vendor's Name: West Virginia Paving, Inc.

Authorized Signature: *Robert Brooks* Date: November 30, 2021

State of West Virginia

County of Kanawha, to-wit:

Taken, subscribed, and sworn to before me this 30 day of November, 2021.

My Commission expires March 10, 2024.



Victoria W. McGrew

AFFIX SEAL HERE



NOTARY PUBLIC



CERTIFICATE OF LIABILITY INSURANCE

DATE (MM/DD/YYYY)

08/28/2020

THIS CERTIFICATE IS ISSUED AS A MATTER OF INFORMATION ONLY AND CONFERS NO RIGHTS UPON THE CERTIFICATE HOLDER. THIS CERTIFICATE DOES NOT AFFIRMATIVELY OR NEGATIVELY AMEND, EXTEND OR ALTER THE COVERAGE AFFORDED BY THE POLICIES BELOW. THIS CERTIFICATE OF INSURANCE DOES NOT CONSTITUTE A CONTRACT BETWEEN THE ISSUING INSURER(S), AUTHORIZED REPRESENTATIVE OR PRODUCER, AND THE CERTIFICATE HOLDER.

IMPORTANT: If the certificate holder is an ADDITIONAL INSURED, the policy(ies) must have ADDITIONAL INSURED provisions or be endorsed. If SUBROGATION IS WAIVED, subject to the terms and conditions of the policy, certain policies may require an endorsement. A statement on this certificate does not confer rights to the certificate holder in lieu of such endorsement(s).

PRODUCER Mountain State Insurance Agency 1206 Kanawha Blvd. E. Suite 100 Charleston WV 25301-2949	CONTACT NAME: Jennifer Drake	PHONE (A/C, No, Ext): (304) 720-2000	FAX (A/C, No): (304) 720-2002
	E-MAIL ADDRESS: jdrake@mountainstateinsurance.com		
INSURED West Virginia Paving, Inc. P.O. Box 544 Dunbar WV 25064	INSURER(S) AFFORDING COVERAGE		NAIC #
	INSURER A : SummitPoint Insurance Company		15136
	INSURER B : Argonaut Insurance Company		19860
	INSURER C :		
	INSURER D :		
	INSURER E :		

COVERAGES **CERTIFICATE NUMBER:** 20 21 WV Paving **REVISION NUMBER:**

THIS IS TO CERTIFY THAT THE POLICIES OF INSURANCE LISTED BELOW HAVE BEEN ISSUED TO THE INSURED NAMED ABOVE FOR THE POLICY PERIOD INDICATED. NOTWITHSTANDING ANY REQUIREMENT, TERM OR CONDITION OF ANY CONTRACT OR OTHER DOCUMENT WITH RESPECT TO WHICH THIS CERTIFICATE MAY BE ISSUED OR MAY PERTAIN, THE INSURANCE AFFORDED BY THE POLICIES DESCRIBED HEREIN IS SUBJECT TO ALL THE TERMS, EXCLUSIONS AND CONDITIONS OF SUCH POLICIES. LIMITS SHOWN MAY HAVE BEEN REDUCED BY PAID CLAIMS.

INSR LTR	TYPE OF INSURANCE	ADDL INSD	SUBR WVD	POLICY NUMBER	POLICY EFF (MM/DD/YYYY)	POLICY EXP (MM/DD/YYYY)	LIMITS
	COMMERCIAL GENERAL LIABILITY <input type="checkbox"/> CLAIMS-MADE <input type="checkbox"/> OCCUR GEN'L AGGREGATE LIMIT APPLIES PER: <input type="checkbox"/> POLICY <input type="checkbox"/> PRO-JECT <input type="checkbox"/> LOC OTHER:						EACH OCCURRENCE \$ DAMAGE TO RENTED PREMISES (Ea occurrence) \$ MED EXP (Any one person) \$ PERSONAL & ADV INJURY \$ GENERAL AGGREGATE \$ PRODUCTS - COMPI/OP AGG \$ \$
	AUTOMOBILE LIABILITY <input type="checkbox"/> ANY AUTO <input type="checkbox"/> OWNED AUTOS ONLY <input type="checkbox"/> SCHEDULED AUTOS <input type="checkbox"/> HIRED AUTOS ONLY <input type="checkbox"/> NON-OWNED AUTOS ONLY <input type="checkbox"/> AUTOS ONLY						COMBINED SINGLE LIMIT (Ea accident) \$ BODILY INJURY (Per person) \$ BODILY INJURY (Per accident) \$ PROPERTY DAMAGE (Per accident) \$ \$
	UMBRELLA LIAB <input type="checkbox"/> OCCUR EXCESS LIAB <input type="checkbox"/> CLAIMS-MADE DED RETENTION \$						EACH OCCURRENCE \$ AGGREGATE \$ \$
A	WORKERS COMPENSATION AND EMPLOYERS' LIABILITY ANY PROPRIETOR/PARTNER/EXECUTIVE OFFICER/MEMBER EXCLUDED? (Mandatory in NH) If yes, describe under DESCRIPTION OF OPERATIONS below	Y/N	N/A	WCS3001197	09/01/2020	09/01/2021	<input checked="" type="checkbox"/> PER STATUTE <input checked="" type="checkbox"/> OTHER WV Code 23-4-2 E.L. EACH ACCIDENT \$ 1,000,000 E.L. DISEASE - EA EMPLOYEE \$ 1,000,000 E.L. DISEASE - POLICY LIMIT \$ 1,000,000
B	Workers Compensation Jones Act			WC928668361384	09/01/2020	09/01/2021	EL Each Accident 1,000,000 EL Disease-EA Employee 1,000,000 EL Disease-Policy Limit 1,000,000

DESCRIPTION OF OPERATIONS / LOCATIONS / VEHICLES (ACORD 101, Additional Remarks Schedule, may be attached if more space is required)

WVDOT-Division of Highways is named as additional insured with regards to General Liability and Auto Liability, where required by written contract.
 Project: ARFQ 0803 DOT2200000014

CERTIFICATE HOLDER West Virginia Dept. of Highways Bldg. 5, RM A-220 1900 Kanawha Blvd. E Charleston, WV 25302	CANCELLATION SHOULD ANY OF THE ABOVE DESCRIBED POLICIES BE CANCELLED BEFORE THE EXPIRATION DATE THEREOF, NOTICE WILL BE DELIVERED IN ACCORDANCE WITH THE POLICY PROVISIONS.
	AUTHORIZED REPRESENTATIVE 

© 1988-2015 ACORD CORPORATION. All rights reserved.



CERTIFICATE OF LIABILITY INSURANCE

DATE (MM/DD/YYYY)

10/29/2021

THIS CERTIFICATE IS ISSUED AS A MATTER OF INFORMATION ONLY AND CONFERS NO RIGHTS UPON THE CERTIFICATE HOLDER. THIS CERTIFICATE DOES NOT AFFIRMATIVELY OR NEGATIVELY AMEND, EXTEND OR ALTER THE COVERAGE AFFORDED BY THE POLICIES BELOW. THIS CERTIFICATE OF INSURANCE DOES NOT CONSTITUTE A CONTRACT BETWEEN THE ISSUING INSURER(S), AUTHORIZED REPRESENTATIVE OR PRODUCER, AND THE CERTIFICATE HOLDER.

IMPORTANT: If the certificate holder is an ADDITIONAL INSURED, the policy(ies) must have ADDITIONAL INSURED provisions or be endorsed. If SUBROGATION IS WAIVED, subject to the terms and conditions of the policy, certain policies may require an endorsement. A statement on this certificate does not confer rights to the certificate holder in lieu of such endorsement(s).

PRODUCER Liberty Mutual Insurance Co. National Insurance East 2000 Westwood Dr. Wausau, WI 54401 www.LibertyMutual.com	CONTACT NAME: Jon Helegda	FAX (A/C, No):
	PHONE (A/C, No, Ext): 513-867-3822	E-MAIL ADDRESS: Oldcastle.certs@LibertyMutual.com
INSURED West Virginia Paving, Inc. (163-DUN) 2950 Charles Avenue Dunbar WV 25064	INSURER(S) AFFORDING COVERAGE	
	INSURER A: Liberty Mutual Fire Insurance Company	NAIC # 23035
	INSURER B:	
	INSURER C:	
	INSURER D:	
	INSURER E:	
	INSURER F:	

COVERAGES

CERTIFICATE NUMBER: 64772642

REVISION NUMBER:

THIS IS TO CERTIFY THAT THE POLICIES OF INSURANCE LISTED BELOW HAVE BEEN ISSUED TO THE INSURED NAMED ABOVE FOR THE POLICY PERIOD INDICATED. NOTWITHSTANDING ANY REQUIREMENT, TERM OR CONDITION OF ANY CONTRACT OR OTHER DOCUMENT WITH RESPECT TO WHICH THIS CERTIFICATE MAY BE ISSUED OR MAY PERTAIN, THE INSURANCE AFFORDED BY THE POLICIES DESCRIBED HEREIN IS SUBJECT TO ALL THE TERMS, EXCLUSIONS AND CONDITIONS OF SUCH POLICIES. LIMITS SHOWN MAY HAVE BEEN REDUCED BY PAID CLAIMS.

INSR LTR	TYPE OF INSURANCE	ADDL SUBR INSD WVD	POLICY NUMBER	POLICY EFF (MM/DD/YYYY)	POLICY EXP (MM/DD/YYYY)	LIMITS	
A	<input checked="" type="checkbox"/> COMMERCIAL GENERAL LIABILITY <input type="checkbox"/> CLAIMS-MADE <input checked="" type="checkbox"/> OCCUR <input checked="" type="checkbox"/> Primary/Non-Contributory <input checked="" type="checkbox"/> Separation of Insured GEN'L AGGREGATE LIMIT APPLIES PER: <input type="checkbox"/> POLICY <input checked="" type="checkbox"/> PRO-JECT <input type="checkbox"/> LOC OTHER:		TB2-C81-004095-111 XCU Coverage Included	9/1/2021	9/1/2022	EACH OCCURRENCE	\$ 2,000,000
						DAMAGE TO RENTED PREMISES (Ea occurrence)	\$ 300,000
						MED EXP (Any one person)	\$ 50,000
						PERSONAL & ADV INJURY	\$ 2,000,000
						GENERAL AGGREGATE	\$ 2,000,000
						PRODUCTS - COMP/OP AGG	\$ 2,000,000
							\$
A	AUTOMOBILE LIABILITY		AS2-C81-004095-121	9/1/2021	9/1/2022	COMBINED SINGLE LIMIT (Ea accident)	\$ 2,000,000
A	<input checked="" type="checkbox"/> ANY AUTO OWNED AUTOS ONLY <input type="checkbox"/> HIRED AUTOS ONLY <input type="checkbox"/> SCHEDULED AUTOS <input type="checkbox"/> NON-OWNED AUTOS ONLY		AS2-C81-054502-521 Physical Damage only: Comprehensive Ded \$10,000 Collision Ded \$10,000	9/1/2021	9/1/2022	BODILY INJURY (Per person)	\$
						BODILY INJURY (Per accident)	\$
						PROPERTY DAMAGE (Per accident)	\$
							\$
	UMBRELLA LIAB					EACH OCCURRENCE	\$
	EXCESS LIAB					AGGREGATE	\$
							\$
	WORKERS COMPENSATION AND EMPLOYERS' LIABILITY					PER STATUTE	
	ANY PROPRIETOR/PARTNER/EXECUTIVE OFFICER/MEMBER EXCLUDED? (Mandatory in NH)	Y/N	N/A			E.L. EACH ACCIDENT	\$
	If yes, describe under DESCRIPTION OF OPERATIONS below					E.L. DISEASE - EA EMPLOYEE	\$
						E.L. DISEASE - POLICY LIMIT	\$

DESCRIPTION OF OPERATIONS / LOCATIONS / VEHICLES (ACORD 101, Additional Remarks Schedule, may be attached if more space is required)

RE: Project: ARFQ 0803 DOT2200000014 - Asphalt Materials, Delivery & Labor by Vendor by County
 WVDOT-Division of Highways is named as additional insured with regards to General Liability and Auto Liability, where required by written contract.

CERTIFICATE HOLDER

CANCELLATION

WVDOT-Division of Highways
 1900 Kanawha Blvd E
 Bldg 5 Rm A737
 Charleston WV 23505

SHOULD ANY OF THE ABOVE DESCRIBED POLICIES BE CANCELLED BEFORE THE EXPIRATION DATE THEREOF, NOTICE WILL BE DELIVERED IN ACCORDANCE WITH THE POLICY PROVISIONS.

AUTHORIZED REPRESENTATIVE

Jon Helegda

© 1988-2015 ACORD CORPORATION. All rights reserved.

CONTRACTOR LICENSE

Authorized by the

West Virginia Contractor Licensing Board

Number: WV001429

Classification:

GENERAL ENGINEERING

WEST VIRGINIA PAVING INC
DBA WEST VIRGINIA PAVING INC
PO BOX 544
DUNBAR, WV 25064-0544

Date Issued

Expiration Date

AUGUST 15, 2021

AUGUST 15, 2022



Authorized Company Signature



Chair, West Virginia Contractor
Licensing Board



**WEST VIRGINIA
CONTRACTOR
LICENSING
BOARD**

A copy of this license must be readily available for inspection by the Board on every job site where contracting work is being performed. This license number must appear in all advertisements, on all bid submissions, and on all fully executed and binding contracts. This license is non-transferrable. This license is being issued under the provisions of West Virginia Code, Chapter 30, Article 42.



**State of West Virginia
DRUG FREE WORKPLACE CONFORMANCE AFFIDAVIT
West Virginia Code §21-1D-5**

**STATE OF WEST VIRGINIA,
COUNTY OF Kanawha, TO-WIT:**

I, Lori Hall, after being first duly sworn, depose and state as follows:

- I am an employee of West Virginia Paving, Inc.; and,
(Company Name)
- I do hereby attest that West Virginia Paving, Inc.
(Company Name)

maintains a written plan for a drug-free workplace policy and that such plan and policy are in compliance with **West Virginia Code §21-1D**.

The above statements are sworn to under the penalty of perjury.

Printed Name: Lori Hall
 Signature: Lori Hall
 Title: HR
 Company Name: West Virginia Paving, Inc.
 Date: September 7th, 2021

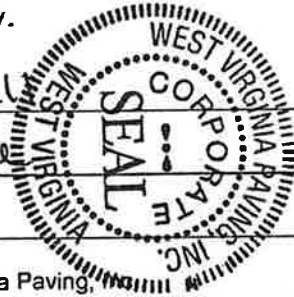

Taken, subscribed and sworn to before me this 7th day of September, 2021.

By Commission expires March 10, 2024

(Seal)

Victoria W McGrew
(Notary Public)

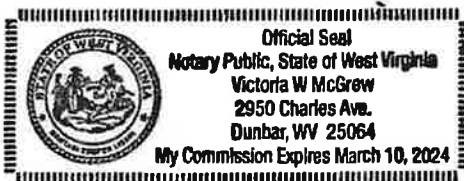

Asphalt Materials Delivery & Labor by Vendor by County

ATTACHMENT A PRICING PAGE (ATT A)

Vendor name shall be entered here by the Vendor: West Virginia Paving, Inc. - Gallipolis, OH

Vendor Instructions: For bidding, Vendor shall mark with an "X" the counties that correspond with the pricing on this page. If Vendor has varied pricing per county, Vendor shall complete a separate set of Pricing Pages (ATT A and ATT B) as well as separate Plant Information Forms (ATT C & ATT D) for each county pricing set. Vendor must complete TWO Pricing Pages (ATT A and ATT B) as well as all Plant Information Forms for each pricing set submitted.

<input type="checkbox"/> Barbour	<input type="checkbox"/> Doddridge	<input type="checkbox"/> Harrison	<input type="checkbox"/> Marshall	<input type="checkbox"/> Morgan	<input type="checkbox"/> Raleigh	<input type="checkbox"/> Upshur
<input type="checkbox"/> Berkeley	<input type="checkbox"/> Fayette	<input checked="" type="checkbox"/> Jackson	<input checked="" type="checkbox"/> Mason	<input type="checkbox"/> Nicholas	<input type="checkbox"/> Randolph	<input type="checkbox"/> Wayne
<input type="checkbox"/> Boone	<input type="checkbox"/> Gilmer	<input type="checkbox"/> Jefferson	<input type="checkbox"/> McDowell	<input type="checkbox"/> Ohio	<input type="checkbox"/> Ritchie	<input type="checkbox"/> Webster
<input type="checkbox"/> Braxton	<input type="checkbox"/> Grant	<input type="checkbox"/> Kanawha	<input type="checkbox"/> Mercer	<input type="checkbox"/> Pendleton	<input type="checkbox"/> Roane	<input type="checkbox"/> Wetzel
<input type="checkbox"/> Brooke	<input type="checkbox"/> Greenbrier	<input type="checkbox"/> Lewis	<input type="checkbox"/> Mineral	<input type="checkbox"/> Pleasants	<input type="checkbox"/> Summers	<input type="checkbox"/> Wirt
<input checked="" type="checkbox"/> Cabell	<input type="checkbox"/> Hampshire	<input type="checkbox"/> Lincoln	<input type="checkbox"/> Mingo	<input type="checkbox"/> Pocahontas	<input type="checkbox"/> Taylor	<input type="checkbox"/> Wood
<input type="checkbox"/> Calhoun	<input type="checkbox"/> Hancock	<input type="checkbox"/> Logan	<input type="checkbox"/> Monongalia	<input type="checkbox"/> Preston	<input type="checkbox"/> Tucker	<input type="checkbox"/> Wyoming
<input type="checkbox"/> Clay	<input type="checkbox"/> Hardy	<input type="checkbox"/> Marion	<input type="checkbox"/> Monroe	<input type="checkbox"/> Putnam	<input type="checkbox"/> Tyler	<input type="checkbox"/> STATEWIDE

Supplier Name - Vendor's Sourced Plant	Contract Item #	Contract Item Description	Unit of Measure	List Price
West Virginia Paving, Inc - Gallipolis, OH Plant		Asphalt Section 401 - Base I	TON	\$62.50
West Virginia Paving, Inc - Gallipolis, OH Plant	A2	Asphalt Section 401 - 25mm Superpave	TON	No Bid
West Virginia Paving, Inc - Gallipolis, OH Plant	A3	Asphalt Section 401 - Base II	TON	\$71.00
West Virginia Paving, Inc - Gallipolis, OH Plant	A4	Asphalt Section 401 - Patch and Level	TON	\$71.00
West Virginia Paving, Inc - Gallipolis, OH Plant	A5	Asphalt Section 401 - Wearing IV	TON	\$73.00
West Virginia Paving, Inc - Gallipolis, OH Plant	A6	Asphalt Section 402 - Wearing IV	TON	No Bid
West Virginia Paving, Inc - Gallipolis, OH Plant	A7	Asphalt Section 401 - 19mm Superpave	TON	No Bid
West Virginia Paving, Inc - Gallipolis, OH Plant	A8	Asphalt Section 401 - Scratch Course	TON	\$78.75
West Virginia Paving, Inc - Gallipolis, OH Plant	A9	Asphalt Section 402 - 9.5mm Superpave	TON	No Bid
West Virginia Paving, Inc - Gallipolis, OH Plant	A10	Asphalt Section 401 - Wearing 1	TON	\$78.75
West Virginia Paving, Inc - Gallipolis, OH Plant	A11	Asphalt Section 402 - Wearing 1	TON	No Bid
West Virginia Paving, Inc - Gallipolis, OH Plant	A12	Asphalt Section 401 - 4.75mm Superpave	TON	No Bid
West Virginia Paving, Inc - Gallipolis, OH Plant	A13	Asphalt Section 402 - 4.75mm Superpave	TON	No Bid
West Virginia Paving, Inc - Gallipolis, OH Plant	A14	Asphalt Section 401 - Wearing III	TON	No Bid
West Virginia Paving, Inc - Gallipolis, OH Plant	A15	Asphalt Section 402 - Wearing III	TON	No Bid
West Virginia Paving, Inc - Gallipolis, OH Plant	A16	Asphalt Section 401 - 12.5mm Superpave	TON	No Bid
West Virginia Paving, Inc - Gallipolis, OH Plant	A17	Asphalt Section 402 - 12.5mm Superpave	TON	No Bid
West Virginia Paving, Inc - Gallipolis, OH Plant	B	Shoulder Stone Placement for Asphalt Section 307 - Class 10	TON	\$57.00
-----	C	Shoulder Stone Mobilization - Complete on Attachment B (ATT B)	LUMP SUM	-----
West Virginia Paving, Inc - Gallipolis, OH Plant	D1	Haul by Vendor Shoulder Stone Placement - First Ton Mile	MILE	\$1.50
West Virginia Paving, Inc - Gallipolis, OH Plant	D2	Haul by Vendor Shoulder Stone Placement - Each Additional Mile	MILE	\$0.27
West Virginia Paving, Inc - Gallipolis, OH Plant	E1	Surcharge for PG Binder - 70 minus 22	TON	\$4.00
West Virginia Paving, Inc - Gallipolis, OH Plant	E2	Surcharge for PG Binder 76 minus 22 ordered in 400 Ton increments	TON	\$12.00
West Virginia Paving, Inc - Gallipolis, OH Plant	F1	Asphalt Haul by Vendor - First Ton Mile	MILE	\$1.50
West Virginia Paving, Inc - Gallipolis, OH Plant	F2	Asphalt Haul by Vendor - Each Additional Mile	MILE	\$0.27
West Virginia Paving, Inc - Gallipolis, OH Plant	G1	Laydown of Materials. Items A and V, Each Site 0 to 100 Tons	TON	\$65.00
West Virginia Paving, Inc - Gallipolis, OH Plant	G2	Laydown of Materials. Items A and V, Each Site 101 to 200 Tons	TON	\$26.00
West Virginia Paving, Inc - Gallipolis, OH Plant	G3	Laydown of Materials. Items A and V, Each Site 201 to 500 Tons	TON	\$11.00
West Virginia Paving, Inc - Gallipolis, OH Plant	G4	Laydown of Materials. Items A and V, Each Site 501 Tons or Greater	TON	\$8.50
-----	H1	Mobilization - Daytime Paving - Complete on Attachment B (ATT B)	LUMP SUM	-----
-----	H2	Mobilization - Nighttime Paving - Complete on Attachment B (ATT B)	LUMP SUM	-----
West Virginia Paving, Inc - Gallipolis, OH Plant	I1	Excavation for Shoulder Paving - 0 to 1000 Sq. Yards	SY	\$5.75
West Virginia Paving, Inc - Gallipolis, OH Plant	I2	Excavation for Shoulder Paving - 1001 to 2000 Sq. Yards	SY	\$3.75
West Virginia Paving, Inc - Gallipolis, OH Plant	I3	Excavation for Shoulder Paving - 2001 to 3000 Sq. Yards	SY	\$2.75
West Virginia Paving, Inc - Gallipolis, OH Plant	I4	Excavation for Shoulder Paving - 3001 Sq. Yards or Greater	SY	\$1.75
West Virginia Paving, Inc - Gallipolis, OH Plant	J1	Asphalt Base I Shoulder Paving Surcharge - 0 to 100 Tons	TON	\$20.00
West Virginia Paving, Inc - Gallipolis, OH Plant	J2	Asphalt Base I Shoulder Paving Surcharge - 101 to 200 Tons	TON	\$15.00
West Virginia Paving, Inc - Gallipolis, OH Plant	J3	Asphalt Base I Shoulder Paving Surcharge - 201 to 500 Tons	TON	\$4.00
West Virginia Paving, Inc - Gallipolis, OH Plant	J4	Asphalt Base I Shoulder Paving Surcharge - 501 Tons or Greater	TON	\$2.00
West Virginia Paving, Inc - Gallipolis, OH Plant	K1	Asphalt Base II Shoulder Paving Surcharge - 0 to 100 Tons	TON	\$20.00
West Virginia Paving, Inc - Gallipolis, OH Plant	K2	Asphalt Base II Shoulder Paving Surcharge - 101 to 200 Tons	TON	\$15.00
West Virginia Paving, Inc - Gallipolis, OH Plant	K3	Asphalt Base II Shoulder Paving Surcharge - 201 to 500 Tons	TON	\$4.00
West Virginia Paving, Inc - Gallipolis, OH Plant	K4	Asphalt Base II Shoulder Paving Surcharge - 501 Tons or Greater	TON	\$2.00
West Virginia Paving, Inc - Gallipolis, OH Plant	L	Asphalt Material for Tack Coat or Prime Material	GAL	\$2.50
West Virginia Paving, Inc - Gallipolis, OH Plant	M	Additional Heel-In Joints	LF	\$12.00
West Virginia Paving, Inc - Gallipolis, OH Plant	N	Skip Paving Surcharge	TON	\$4.50
West Virginia Paving, Inc - Gallipolis, OH Plant	O1	Pavement Profiling/Milling-WVDOH Owns Millings 0 to 250 Sq. Yards	SY	\$20.85
West Virginia Paving, Inc - Gallipolis, OH Plant	O2	Pavement Profiling/Milling-WVDOH Owns Millings 251 to 500 Sq. Yards	SY	\$15.85
West Virginia Paving, Inc - Gallipolis, OH Plant	O3	Pavement Profiling/Milling-WVDOH Owns Millings 501 to 1000 Sq. Yards	SY	\$10.85
West Virginia Paving, Inc - Gallipolis, OH Plant	O4	Pavement Profiling/Milling-WVDOH Owns Millings 1001 to 2500 Sq. Yards	SY	\$5.85
West Virginia Paving, Inc - Gallipolis, OH Plant	O5	Pavement Profiling/Milling-WVDOH Owns Millings 2501 to 5000 Sq. Yards	SY	\$3.95
West Virginia Paving, Inc - Gallipolis, OH Plant	O6	Pavement Profiling/Milling-WVDOH Owns Millings 5001 Sq. Yards or Greater	SY	\$2.85
West Virginia Paving, Inc - Gallipolis, OH Plant	P1	Pavement Profiling/Milling-Vendor Owns Millings 0 to 250 Sq. Yards	SY	\$20.45
West Virginia Paving, Inc - Gallipolis, OH Plant	P2	Pavement Profiling/Milling-Vendor Owns Millings 251 to 500 Sq. Yards	SY	\$15.45
West Virginia Paving, Inc - Gallipolis, OH Plant	P3	Pavement Profiling/Milling-Vendor Owns Millings 501 to 1000 Sq. Yards	SY	\$10.45
West Virginia Paving, Inc - Gallipolis, OH Plant	P4	Pavement Profiling/Milling-Vendor Owns Millings 1001 to 2500 Sq. Yards	SY	\$5.45
West Virginia Paving, Inc - Gallipolis, OH Plant	P5	Pavement Profiling/Milling-Vendor Owns Millings 2501 to 5000 Sq. Yards	SY	\$3.55
West Virginia Paving, Inc - Gallipolis, OH Plant	P6	Pavement Profiling/Milling-Vendor Owns Millings 5001 Sq. Yards or Greater	SY	\$2.45
-----	Q	Mobilization - Pavement Profiling/Milling - Complete on Attachment B (ATT B)	LUMP SUM	-----

Asphalt Materials Delivery & Labor by Vendor by County

ATTACHMENT A PRICING PAGE (ATT A)

Vendor name shall be entered here by the Vendor: West Virginia Paving, Inc. - Gallipolis, OH

Vendor Instructions: For bidding, Vendor shall mark with an "X" the counties that correspond with the pricing on this page. If Vendor has varied pricing per county, Vendor shall complete a separate set of Pricing Pages (ATT A and ATT B) as well as separate Plant Information Forms (ATT C & ATT D) for each county pricing set. Vendor must complete TWO Pricing Pages (ATT A and ATT B) as well as all Plant Information Forms for each pricing set submitted.

<input type="checkbox"/> Barbour	<input type="checkbox"/> Doddridge	<input type="checkbox"/> Harrison	<input type="checkbox"/> Marshall	<input type="checkbox"/> Morgan	<input type="checkbox"/> Raleigh	<input type="checkbox"/> Upshur
<input type="checkbox"/> Berkeley	<input type="checkbox"/> Fayette	<input checked="" type="checkbox"/> Jackson	<input checked="" type="checkbox"/> Mason	<input type="checkbox"/> Nicholas	<input type="checkbox"/> Randolph	<input type="checkbox"/> Wayne
<input type="checkbox"/> Boone	<input type="checkbox"/> Gilmer	<input type="checkbox"/> Jefferson	<input type="checkbox"/> McDowell	<input type="checkbox"/> Ohio	<input type="checkbox"/> Ritchie	<input type="checkbox"/> Webster
<input type="checkbox"/> Braxton	<input type="checkbox"/> Grant	<input type="checkbox"/> Kanawha	<input type="checkbox"/> Mercer	<input type="checkbox"/> Pendleton	<input type="checkbox"/> Roane	<input type="checkbox"/> Wetzel
<input type="checkbox"/> Brooke	<input type="checkbox"/> Greenbrier	<input type="checkbox"/> Lewis	<input type="checkbox"/> Mineral	<input type="checkbox"/> Pleasants	<input type="checkbox"/> Summers	<input type="checkbox"/> Wirt
<input checked="" type="checkbox"/> Cabell	<input type="checkbox"/> Hampshire	<input type="checkbox"/> Lincoln	<input type="checkbox"/> Mingo	<input type="checkbox"/> Pocahontas	<input type="checkbox"/> Taylor	<input type="checkbox"/> Wood
<input type="checkbox"/> Calhoun	<input type="checkbox"/> Hancock	<input type="checkbox"/> Logan	<input type="checkbox"/> Monongalia	<input type="checkbox"/> Preston	<input type="checkbox"/> Tucker	<input type="checkbox"/> Wyoming
<input type="checkbox"/> Clay	<input type="checkbox"/> Hardy	<input type="checkbox"/> Marion	<input type="checkbox"/> Monroe	<input type="checkbox"/> Putnam	<input type="checkbox"/> Tyler	<input type="checkbox"/> STATEWIDE

Supplier Name - Vendor's Sourced Plant	Contract Item #	Contract Item Description	Unit of Measure	List Price
West Virginia Paving, Inc - Gallipolis, OH Plant	R1	Haul of Profiled/Milled Cuttings, First 10 Miles (Included with Contract Items O & P)	MILE	No Add'l Charge
West Virginia Paving, Inc - Gallipolis, OH Plant	R2	Haul of Profiled/Milled Cuttings, Each Additional Mile (Above 10 Miles)	LOADED MILE	\$4.80
West Virginia Paving, Inc - Gallipolis, OH Plant	S	Pavement Repair - Asphalt Base II	TON	\$325.00
West Virginia Paving, Inc - Gallipolis, OH Plant	T	Asphalt HPTO - SP496 - PG 64E-22 ordered 400 Ton increments	TON	No Bid
West Virginia Paving, Inc - Gallipolis, OH Plant	U	Non-Tracking Tack - to be used with T	GAL	No Bid
West Virginia Paving, Inc - Gallipolis, OH Plant	V	Lay Down of Materials - to be used with T - 400 Ton or Greater	TON	No Bid
West Virginia Paving, Inc - Gallipolis, OH Plant	W	Ultra-Thin Asphalt Overlay - SP498	TON	No Bid
West Virginia Paving, Inc - Gallipolis, OH Plant	X1	Fine Milling of Asphalt Pavement Surfaces - 0 to 250 Sq. Yards	SY	\$22.85
West Virginia Paving, Inc - Gallipolis, OH Plant	X2	Fine Milling of Asphalt Pavement Surfaces - 251 to 500 Sq. Yards	SY	\$17.85
West Virginia Paving, Inc - Gallipolis, OH Plant	X3	Fine Milling of Asphalt Pavement Surfaces - 501 to 1000 Sq. Yards	SY	\$12.85
West Virginia Paving, Inc - Gallipolis, OH Plant	X4	Fine Milling of Asphalt Pavement Surfaces 1001 to 2500 Sq. Yards	SY	\$6.70
West Virginia Paving, Inc - Gallipolis, OH Plant	X5	Fine Milling of Asphalt Pavement Surfaces 2501 to 5000 Sq. Yards	SY	\$4.85
West Virginia Paving, Inc - Gallipolis, OH Plant	X6	Fine Milling of Asphalt Pavement Surfaces - 5001 SY or Greater	SY	\$3.05
West Virginia Paving, Inc - Gallipolis, OH Plant	Y	Milled Rumble Strips	LF	\$0.50
	Z	Mobilization - Milled Rumble Strips - Complete on Attachment B (ATT B)	LUMP SUM	
West Virginia Paving, Inc - Gallipolis, OH Plant	AA	Surcharge for Parking Lot and Facility Paving - Items A	TON	\$7.00
West Virginia Paving, Inc - Gallipolis, OH Plant	AB	Cleaning and Sweeping	SY	\$0.01
West Virginia Paving, Inc - Gallipolis, OH Plant	AC1	Maintaining Traffic - Pilot Truck and Driver	DAY	\$900.00
West Virginia Paving, Inc - Gallipolis, OH Plant	AC2	Maintaining Traffic - Traffic Control Devices	UNIT	\$1.00
West Virginia Paving, Inc - Gallipolis, OH Plant	AC3	Maintaining Traffic - Flagger	HOUR	\$66.00
West Virginia Paving, Inc - Gallipolis, OH Plant	AC4	Maintaining Traffic - Arrow Board	DAY	\$30.00
West Virginia Paving, Inc - Gallipolis, OH Plant	AD1	Off-Season Plant Opening - First Day	DAY	\$3,500.00
West Virginia Paving, Inc - Gallipolis, OH Plant	AD2	Off-Season Plant Opening - Each Additional Day	DAY	\$1,000.00

Total Number of Attachment A pages submitted by Vendor is: 14

Asphalt Materials Delivery & Labor by Vendor by County

ATTACHMENT A PRICING PAGE (ATT A)

Vendor name shall be entered here by the Vendor: West Virginia Paving, Inc. - Gallipolis, OH

Vendor Instructions: For bidding, Vendor shall mark with an "X" the counties that correspond with the pricing on this page. If Vendor has varied pricing per county, Vendor shall complete a separate set of Pricing Pages (ATT A and ATT B) as well as separate Plant Information Forms (ATT C & ATT D) for each county pricing set. Vendor must complete TWO Pricing Pages (ATT A and ATT B) as well as all Plant Information Forms for each pricing set submitted.

<input type="checkbox"/> Barbour	<input type="checkbox"/> Doddridge	<input type="checkbox"/> Harrison	<input type="checkbox"/> Marshall	<input type="checkbox"/> Morgan	<input type="checkbox"/> Raleigh	<input type="checkbox"/> Upshur
<input type="checkbox"/> Berkeley	<input type="checkbox"/> Fayette	<input checked="" type="checkbox"/> Jackson	<input checked="" type="checkbox"/> Mason	<input type="checkbox"/> Nicholas	<input type="checkbox"/> Randolph	<input type="checkbox"/> Wayne
<input type="checkbox"/> Boone	<input type="checkbox"/> Gilmer	<input type="checkbox"/> Jefferson	<input type="checkbox"/> McDowell	<input type="checkbox"/> Ohio	<input type="checkbox"/> Ritchie	<input type="checkbox"/> Webster
<input type="checkbox"/> Braxton	<input type="checkbox"/> Grant	<input type="checkbox"/> Kanawha	<input type="checkbox"/> Mercer	<input type="checkbox"/> Pendleton	<input type="checkbox"/> Roane	<input type="checkbox"/> Wetzel
<input type="checkbox"/> Brooke	<input type="checkbox"/> Greenbrier	<input type="checkbox"/> Lewis	<input type="checkbox"/> Mineral	<input type="checkbox"/> Pleasants	<input type="checkbox"/> Summers	<input type="checkbox"/> Wirt
<input checked="" type="checkbox"/> Cabell	<input type="checkbox"/> Hampshire	<input type="checkbox"/> Lincoln	<input type="checkbox"/> Mingo	<input type="checkbox"/> Pocahontas	<input type="checkbox"/> Taylor	<input type="checkbox"/> Wood
<input type="checkbox"/> Calhoun	<input type="checkbox"/> Hancock	<input type="checkbox"/> Logan	<input type="checkbox"/> Monongalia	<input type="checkbox"/> Preston	<input type="checkbox"/> Tucker	<input type="checkbox"/> Wyoming
<input type="checkbox"/> Clay	<input type="checkbox"/> Hardy	<input type="checkbox"/> Marion	<input type="checkbox"/> Monroe	<input type="checkbox"/> Putnam	<input type="checkbox"/> Tyler	<input type="checkbox"/> STATEWIDE

Supplier Name - Vendor's Sourced Plant	Contract Item #	Contract Item Description	Unit of Measure	List Price
West Virginia Paving, Inc - Gallipolis, OH Plant		Asphalt Section 401 - Base I	TON	\$62.50
West Virginia Paving, Inc - Gallipolis, OH Plant	A2	Asphalt Section 401 - 25mm Superpave	TON	No Bid
West Virginia Paving, Inc - Gallipolis, OH Plant	A3	Asphalt Section 401 - Base II	TON	\$71.00
West Virginia Paving, Inc - Gallipolis, OH Plant	A4	Asphalt Section 401 - Patch and Level	TON	\$71.00
West Virginia Paving, Inc - Gallipolis, OH Plant	A5	Asphalt Section 401 - Wearing IV	TON	\$73.00
West Virginia Paving, Inc - Gallipolis, OH Plant	A6	Asphalt Section 402 - Wearing IV	TON	No Bid
West Virginia Paving, Inc - Gallipolis, OH Plant	A7	Asphalt Section 401 - 19mm Superpave	TON	No Bid
West Virginia Paving, Inc - Gallipolis, OH Plant	A8	Asphalt Section 401 - Scratch Course	TON	\$78.75
West Virginia Paving, Inc - Gallipolis, OH Plant	A9	Asphalt Section 402 - 9.5mm Superpave	TON	No Bid
West Virginia Paving, Inc - Gallipolis, OH Plant	A10	Asphalt Section 401 - Wearing 1	TON	\$78.75
West Virginia Paving, Inc - Gallipolis, OH Plant	A11	Asphalt Section 402 - Wearing 1	TON	No Bid
West Virginia Paving, Inc - Gallipolis, OH Plant	A12	Asphalt Section 401 - 4.75mm Superpave	TON	No Bid
West Virginia Paving, Inc - Gallipolis, OH Plant	A13	Asphalt Section 402 - 4.75mm Superpave	TON	No Bid
West Virginia Paving, Inc - Gallipolis, OH Plant	A14	Asphalt Section 401 - Wearing III	TON	No Bid
West Virginia Paving, Inc - Gallipolis, OH Plant	A15	Asphalt Section 402 - Wearing III	TON	No Bid
West Virginia Paving, Inc - Gallipolis, OH Plant	A16	Asphalt Section 401 - 12.5mm Superpave	TON	No Bid
West Virginia Paving, Inc - Gallipolis, OH Plant	A17	Asphalt Section 402 - 12.5mm Superpave	TON	No Bid
West Virginia Paving, Inc - Gallipolis, OH Plant	B	Shoulder Stone Placement for Asphalt Section 307 - Class 10	TON	\$57.00
	C	Shoulder Stone Mobilization - Complete on Attachment B (ATT B)	LUMP SUM	-----
West Virginia Paving, Inc - Gallipolis, OH Plant	D1	Haul by Vendor Shoulder Stone Placement - First Ton Mile	MILE	\$1.50
West Virginia Paving, Inc - Gallipolis, OH Plant	D2	Haul by Vendor Shoulder Stone Placement - Each Additional Mile	MILE	\$0.27
West Virginia Paving, Inc - Gallipolis, OH Plant	E1	Surcharge for PG Binder - 70 minus 22	TON	\$4.00
West Virginia Paving, Inc - Gallipolis, OH Plant	E2	Surcharge for PG Binder 76 minus 22 ordered in 400 Ton increments	TON	\$12.00
West Virginia Paving, Inc - Gallipolis, OH Plant	F1	Asphalt Haul by Vendor - First Ton Mile	MILE	\$1.50
West Virginia Paving, Inc - Gallipolis, OH Plant	F2	Asphalt Haul by Vendor - Each Additional Mile	MILE	\$0.27
West Virginia Paving, Inc - Gallipolis, OH Plant	G1	Laydown of Materials. Items A and V, Each Site 0 to 100 Tons	TON	\$65.00
West Virginia Paving, Inc - Gallipolis, OH Plant	G2	Laydown of Materials. Items A and V, Each Site 101 to 200 Tons	TON	\$26.00
West Virginia Paving, Inc - Gallipolis, OH Plant	G3	Laydown of Materials. Items A and V, Each Site 201 to 500 Tons	TON	\$11.00
West Virginia Paving, Inc - Gallipolis, OH Plant	G4	Laydown of Materials. Items A and V, Each Site 501 Tons or Greater	TON	\$8.50
	H1	Mobilization - Daytime Paving - Complete on Attachment B (ATT B)	LUMP SUM	-----
	H2	Mobilization - Nighttime Paving - Complete on Attachment B (ATT B)	LUMP SUM	-----
West Virginia Paving, Inc - Gallipolis, OH Plant	I1	Excavation for Shoulder Paving - 0 to 1000 Sq. Yards	SY	\$5.75
West Virginia Paving, Inc - Gallipolis, OH Plant	I2	Excavation for Shoulder Paving - 1001 to 2000 Sq. Yards	SY	\$3.75
West Virginia Paving, Inc - Gallipolis, OH Plant	I3	Excavation for Shoulder Paving - 2001 to 3000 Sq. Yards	SY	\$2.75
West Virginia Paving, Inc - Gallipolis, OH Plant	I4	Excavation for Shoulder Paving - 3001 Sq. Yards or Greater	SY	\$1.75
West Virginia Paving, Inc - Gallipolis, OH Plant	J1	Asphalt Base I Shoulder Paving Surcharge - 0 to 100 Tons	TON	\$20.00
West Virginia Paving, Inc - Gallipolis, OH Plant	J2	Asphalt Base I Shoulder Paving Surcharge - 101 to 200 Tons	TON	\$15.00
West Virginia Paving, Inc - Gallipolis, OH Plant	J3	Asphalt Base I Shoulder Paving Surcharge - 201 to 500 Tons	TON	\$4.00
West Virginia Paving, Inc - Gallipolis, OH Plant	J4	Asphalt Base I Shoulder Paving Surcharge - 501 Tons or Greater	TON	\$2.00
West Virginia Paving, Inc - Gallipolis, OH Plant	K1	Asphalt Base II Shoulder Paving Surcharge - 0 to 100 Tons	TON	\$20.00
West Virginia Paving, Inc - Gallipolis, OH Plant	K2	Asphalt Base II Shoulder Paving Surcharge - 101 to 200 Tons	TON	\$15.00
West Virginia Paving, Inc - Gallipolis, OH Plant	K3	Asphalt Base II Shoulder Paving Surcharge - 201 to 500 Tons	TON	\$4.00
West Virginia Paving, Inc - Gallipolis, OH Plant	K4	Asphalt Base II Shoulder Paving Surcharge - 501 Tons or Greater	TON	\$2.00
West Virginia Paving, Inc - Gallipolis, OH Plant	L	Asphalt Material for Tack Coat or Prime Material	GAL	\$2.50
West Virginia Paving, Inc - Gallipolis, OH Plant	M	Additional Heel-In Joints	LF	\$12.00
West Virginia Paving, Inc - Gallipolis, OH Plant	N	Skip Paving Surcharge	TON	\$4.50
West Virginia Paving, Inc - Gallipolis, OH Plant	O1	Pavement Profiling/Milling-WVDOH Owns Millings 0 to 250 Sq. Yards	SY	\$20.85
West Virginia Paving, Inc - Gallipolis, OH Plant	O2	Pavement Profiling/Milling-WVDOH Owns Millings 251 to 500 Sq. Yards	SY	\$15.85
West Virginia Paving, Inc - Gallipolis, OH Plant	O3	Pavement Profiling/Milling-WVDOH Owns Millings 501 to 1000 Sq. Yards	SY	\$10.85
West Virginia Paving, Inc - Gallipolis, OH Plant	O4	Pavement Profiling/Milling-WVDOH Owns Millings 1001 to 2500 Sq. Yards	SY	\$5.85
West Virginia Paving, Inc - Gallipolis, OH Plant	O5	Pavement Profiling/Milling-WVDOH Owns Millings 2501 to 5000 Sq. Yards	SY	\$3.95
West Virginia Paving, Inc - Gallipolis, OH Plant	O6	Pavement Profiling/Milling-WVDOH Owns Millings 5001 Sq. Yards or Greater	SY	\$2.85
West Virginia Paving, Inc - Gallipolis, OH Plant	P1	Pavement Profiling/Milling-Vendor Owns Millings 0 to 250 Sq. Yards	SY	\$20.45
West Virginia Paving, Inc - Gallipolis, OH Plant	P2	Pavement Profiling/Milling-Vendor Owns Millings 251 to 500 Sq. Yards	SY	\$15.45
West Virginia Paving, Inc - Gallipolis, OH Plant	P3	Pavement Profiling/Milling-Vendor Owns Millings 501 to 1000 Sq. Yards	SY	\$10.45
West Virginia Paving, Inc - Gallipolis, OH Plant	P4	Pavement Profiling/Milling-Vendor Owns Millings 1001 to 2500 Sq. Yards	SY	\$5.45
West Virginia Paving, Inc - Gallipolis, OH Plant	P5	Pavement Profiling/Milling-Vendor Owns Millings 2501 to 5000 Sq. Yards	SY	\$3.55
West Virginia Paving, Inc - Gallipolis, OH Plant	P6	Pavement Profiling/Milling-Vendor Owns Millings 5001 Sq. Yards or Greater	SY	\$2.45
	Q	Mobilization - Pavement Profiling/Milling - Complete on Attachment B (ATT B)	LUMP SUM	-----

Asphalt Materials Delivery & Labor by Vendor by County

ATTACHMENT A PRICING PAGE (ATT A)

Vendor name shall be entered here by the Vendor: West Virginia Paving, Inc. - Gallipolis, OH

Vendor Instructions: For bidding, Vendor shall mark with an "X" the counties that correspond with the pricing on this page. If Vendor has varied pricing per county, Vendor shall complete a separate set of Pricing Pages (ATT A and ATT B) as well as separate Plant Information Forms (ATT C & ATT D) for each county pricing set. Vendor must complete TWO Pricing Pages (ATT A and ATT B) as well as all Plant Information Forms for each pricing set submitted.

<input type="checkbox"/> Barbour	<input type="checkbox"/> Doddridge	<input type="checkbox"/> Harrison	<input type="checkbox"/> Marshall	<input type="checkbox"/> Morgan	<input type="checkbox"/> Raleigh	<input type="checkbox"/> Upshur
<input type="checkbox"/> Berkeley	<input type="checkbox"/> Fayette	<input checked="" type="checkbox"/> Jackson	<input checked="" type="checkbox"/> Mason	<input type="checkbox"/> Nicholas	<input type="checkbox"/> Randolph	<input type="checkbox"/> Wayne
<input type="checkbox"/> Boone	<input type="checkbox"/> Gilmer	<input type="checkbox"/> Jefferson	<input type="checkbox"/> McDowell	<input type="checkbox"/> Ohio	<input type="checkbox"/> Ritchie	<input type="checkbox"/> Webster
<input type="checkbox"/> Braxton	<input type="checkbox"/> Grant	<input type="checkbox"/> Kanawha	<input type="checkbox"/> Mercer	<input type="checkbox"/> Pendleton	<input type="checkbox"/> Roane	<input type="checkbox"/> Wetzel
<input type="checkbox"/> Brooke	<input type="checkbox"/> Greenbrier	<input type="checkbox"/> Lewis	<input type="checkbox"/> Mineral	<input type="checkbox"/> Pleasants	<input type="checkbox"/> Summers	<input type="checkbox"/> Wirt
<input checked="" type="checkbox"/> Cabell	<input type="checkbox"/> Hampshire	<input type="checkbox"/> Lincoln	<input type="checkbox"/> Mingo	<input type="checkbox"/> Pocahontas	<input type="checkbox"/> Taylor	<input type="checkbox"/> Wood
<input type="checkbox"/> Calhoun	<input type="checkbox"/> Hancock	<input type="checkbox"/> Logan	<input type="checkbox"/> Monongalia	<input type="checkbox"/> Preston	<input type="checkbox"/> Tucker	<input type="checkbox"/> Wyoming
<input type="checkbox"/> Clay	<input type="checkbox"/> Hardy	<input type="checkbox"/> Marion	<input type="checkbox"/> Monroe	<input type="checkbox"/> Putnam	<input type="checkbox"/> Tyler	<input type="checkbox"/> STATEWIDE

Supplier Name - Vendor's Sourced Plant	Contract Item #	Contract Item Description	Unit of Measure	List Price
West Virginia Paving, Inc - Gallipolis, OH Plant	R1	Haul of Profiled/Milled Cuttings, First 10 Miles (Included with Contract Items O & P)	MILE	No Add'l Charge
West Virginia Paving, Inc - Gallipolis, OH Plant	R2	Haul of Profiled/Milled Cuttings, Each Additional Mile (Above 10 Miles)	LOADED MILE	\$4.80
West Virginia Paving, Inc - Gallipolis, OH Plant	S	Pavement Repair - Asphalt Base II	TON	\$325.00
West Virginia Paving, Inc - Gallipolis, OH Plant	T	Asphalt HPTO - SP496 - PG 64E-22 ordered 400 Ton increments	TON	No Bid
West Virginia Paving, Inc - Gallipolis, OH Plant	U	Non-Tracking Tack - to be used with T	GAL	No Bid
West Virginia Paving, Inc - Gallipolis, OH Plant	V	Lay Down of Materials - to be used with T - 400 Ton or Greater	TON	No Bid
West Virginia Paving, Inc - Gallipolis, OH Plant	W	Ultra-Thin Asphalt Overlay - SP498	TON	No Bid
West Virginia Paving, Inc - Gallipolis, OH Plant	X1	Fine Milling of Asphalt Pavement Surfaces - 0 to 250 Sq. Yards	SY	\$22.85
West Virginia Paving, Inc - Gallipolis, OH Plant	X2	Fine Milling of Asphalt Pavement Surfaces - 251 to 500 Sq. Yards	SY	\$17.85
West Virginia Paving, Inc - Gallipolis, OH Plant	X3	Fine Milling of Asphalt Pavement Surfaces - 501 to 1000 Sq. Yards	SY	\$12.85
West Virginia Paving, Inc - Gallipolis, OH Plant	X4	Fine Milling of Asphalt Pavement Surfaces 1001 to 2500 Sq. Yards	SY	\$6.70
West Virginia Paving, Inc - Gallipolis, OH Plant	X5	Fine Milling of Asphalt Pavement Surfaces 2501 to 5000 Sq. Yards	SY	\$4.85
West Virginia Paving, Inc - Gallipolis, OH Plant	X6	Fine Milling of Asphalt Pavement Surfaces - 5001 SY or Greater	SY	\$3.05
West Virginia Paving, Inc - Gallipolis, OH Plant	Y	Milled Rumble Strips	LF	\$0.50
	Z	Mobilization - Milled Rumble Strips - Complete on Attachment B (ATT B)	LUMP SUM	
West Virginia Paving, Inc - Gallipolis, OH Plant	AA	Surcharge for Parking Lot and Facility Paving - Items A	TON	\$7.00
West Virginia Paving, Inc - Gallipolis, OH Plant	AB	Cleaning and Sweeping	SY	\$0.01
West Virginia Paving, Inc - Gallipolis, OH Plant	AC1	Maintaining Traffic - Pilot Truck and Driver	DAY	\$900.00
West Virginia Paving, Inc - Gallipolis, OH Plant	AC2	Maintaining Traffic - Traffic Control Devices	UNIT	\$1.00
West Virginia Paving, Inc - Gallipolis, OH Plant	AC3	Maintaining Traffic - Flagger	HOUR	\$66.00
West Virginia Paving, Inc - Gallipolis, OH Plant	AC4	Maintaining Traffic - Arrow Board	DAY	\$30.00
West Virginia Paving, Inc - Gallipolis, OH Plant	AD1	Off-Season Plant Opening - First Day	DAY	\$3,500.00
West Virginia Paving, Inc - Gallipolis, OH Plant	AD2	Off-Season Plant Opening - Each Additional Day	DAY	\$1,000.00

Total Number of Attachment A pages submitted by Vendor is: 14

Asphalt Materials Delivery & Labor by Vendor by County

ATTACHMENT A PRICING PAGE (ATT A)

Vendor name shall be entered here by the Vendor: West Virginia Paving, Inc. - Camden Materials

Vendor Instructions: For bidding, Vendor shall mark with an "X" the counties that correspond with the pricing on this page. If Vendor has varied pricing per county, Vendor shall complete a separate set of Pricing Pages (ATT A and ATT B) as well as separate Plant Information Forms (ATT C & ATT D) for each county pricing set. Vendor must complete TWO Pricing Pages (ATT A and ATT B) as well as all Plant Information Forms for each pricing set submitted.

<input type="checkbox"/> Barbour	<input type="checkbox"/> Doddridge	<input type="checkbox"/> Harrison	<input type="checkbox"/> Marshall	<input type="checkbox"/> Morgan	<input type="checkbox"/> Raleigh	<input type="checkbox"/> Upshur
<input type="checkbox"/> Berkeley	<input type="checkbox"/> Fayette	<input checked="" type="checkbox"/> Jackson	<input type="checkbox"/> Mason	<input type="checkbox"/> Nicholas	<input type="checkbox"/> Randolph	<input type="checkbox"/> Wayne
<input type="checkbox"/> Boone	<input type="checkbox"/> Gilmer	<input type="checkbox"/> Jefferson	<input type="checkbox"/> McDowell	<input type="checkbox"/> Ohio	<input checked="" type="checkbox"/> Ritchie	<input type="checkbox"/> Webster
<input type="checkbox"/> Braxton	<input type="checkbox"/> Grant	<input type="checkbox"/> Kanawha	<input type="checkbox"/> Mercer	<input type="checkbox"/> Pendleton	<input checked="" type="checkbox"/> Roane	<input type="checkbox"/> Wetzel
<input type="checkbox"/> Brooke	<input type="checkbox"/> Greenbrier	<input type="checkbox"/> Lewis	<input type="checkbox"/> Mineral	<input checked="" type="checkbox"/> Pleasants	<input type="checkbox"/> Summers	<input checked="" type="checkbox"/> Wirt
<input type="checkbox"/> Cabell	<input type="checkbox"/> Hampshire	<input type="checkbox"/> Lincoln	<input type="checkbox"/> Mingo	<input type="checkbox"/> Pocahontas	<input type="checkbox"/> Taylor	<input checked="" type="checkbox"/> Wood
<input checked="" type="checkbox"/> Calhoun	<input type="checkbox"/> Hancock	<input type="checkbox"/> Logan	<input type="checkbox"/> Monongalia	<input type="checkbox"/> Preston	<input type="checkbox"/> Tucker	<input type="checkbox"/> Wyoming
<input type="checkbox"/> Clay	<input type="checkbox"/> Hardy	<input type="checkbox"/> Marion	<input type="checkbox"/> Monroe	<input type="checkbox"/> Putnam	<input type="checkbox"/> Tyler	STATEWIDE

Supplier Name - Vendor's Sourced Plant	Contract Item #	Contract Item Description	Unit of Measure	List Price
West Virginia Paving, Inc - Camden Materials		Asphalt Section 401 - Base I	TON	No Bid
West Virginia Paving, Inc - Camden Materials	A2	Asphalt Section 401 - 25mm Superpave	TON	No Bid
West Virginia Paving, Inc - Camden Materials	A3	Asphalt Section 401 - Base II	TON	No Bid
West Virginia Paving, Inc - Camden Materials	A4	Asphalt Section 401 - Patch and Level	TON	No Bid
West Virginia Paving, Inc - Camden Materials	A5	Asphalt Section 401 - Wearing IV	TON	No Bid
West Virginia Paving, Inc - Camden Materials	A6	Asphalt Section 402 - Wearing IV	TON	No Bid
West Virginia Paving, Inc - Camden Materials	A7	Asphalt Section 401 - 19mm Superpave	TON	No Bid
West Virginia Paving, Inc - Camden Materials	A8	Asphalt Section 401 - Scratch Course	TON	No Bid
West Virginia Paving, Inc - Camden Materials	A9	Asphalt Section 402 - 9.5mm Superpave	TON	No Bid
West Virginia Paving, Inc - Camden Materials	A10	Asphalt Section 401 - Wearing 1	TON	No Bid
West Virginia Paving, Inc - Camden Materials	A11	Asphalt Section 402 - Wearing 1	TON	No Bid
West Virginia Paving, Inc - Camden Materials	A12	Asphalt Section 401 - 4.75mm Superpave	TON	No Bid
West Virginia Paving, Inc - Camden Materials	A13	Asphalt Section 402 - 4.75mm Superpave	TON	No Bid
West Virginia Paving, Inc - Camden Materials	A14	Asphalt Section 401 - Wearing III	TON	No Bid
West Virginia Paving, Inc - Camden Materials	A15	Asphalt Section 402 - Wearing III	TON	No Bid
West Virginia Paving, Inc - Camden Materials	A16	Asphalt Section 401 - 12.5mm Superpave	TON	No Bid
West Virginia Paving, Inc - Camden Materials	A17	Asphalt Section 402 - 12.5mm Superpave	TON	No Bid
West Virginia Paving, Inc - Camden Materials	B	Shoulder Stone Placement for Asphalt Section 307 - Class 10	TON	\$57.00
	C	Shoulder Stone Mobilization - Complete on Attachment B (ATT B)	LUMP SUM	-----
West Virginia Paving, Inc - Camden Materials	D1	Haul by Vendor Shoulder Stone Placement - First Ton Mile	MILE	\$1.50
West Virginia Paving, Inc - Camden Materials	D2	Haul by Vendor Shoulder Stone Placement - Each Additional Mile	MILE	\$0.24
West Virginia Paving, Inc - Camden Materials	E1	Surcharge for PG Binder - 70 minus 22	TON	No Bid
West Virginia Paving, Inc - Camden Materials	E2	Surcharge for PG Binder 76 minus 22 ordered in 400 Ton increments	TON	No Bid
West Virginia Paving, Inc - Camden Materials	F1	Asphalt Haul by Vendor - First Ton Mile	MILE	\$1.50
West Virginia Paving, Inc - Camden Materials	F2	Asphalt Haul by Vendor - Each Additional Mile	MILE	\$0.21
West Virginia Paving, Inc - Camden Materials	G1	Laydown of Materials. Items A and V, Each Site 0 to 100 Tons	TON	\$65.00
West Virginia Paving, Inc - Camden Materials	G2	Laydown of Materials. Items A and V, Each Site 101 to 200 Tons	TON	\$26.00
West Virginia Paving, Inc - Camden Materials	G3	Laydown of Materials. Items A and V, Each Site 201 to 500 Tons	TON	\$11.00
West Virginia Paving, Inc - Camden Materials	G4	Laydown of Materials. Items A and V, Each Site 501 Tons or Greater	TON	\$8.50
	H1	Mobilization - Daytime Paving - Complete on Attachment B (ATT B)	LUMP SUM	-----
	H2	Mobilization - Nighttime Paving - Complete on Attachment B (ATT B)	LUMP SUM	-----
West Virginia Paving, Inc - Camden Materials	I1	Excavation for Shoulder Paving - 0 to 1000 Sq. Yards	SY	\$5.75
West Virginia Paving, Inc - Camden Materials	I2	Excavation for Shoulder Paving - 1001 to 2000 Sq. Yards	SY	\$3.75
West Virginia Paving, Inc - Camden Materials	I3	Excavation for Shoulder Paving - 2001 to 3000 Sq. Yards	SY	\$2.75
West Virginia Paving, Inc - Camden Materials	I4	Excavation for Shoulder Paving - 3001 Sq. Yards or Greater	SY	\$1.75
West Virginia Paving, Inc - Camden Materials	J1	Asphalt Base I Shoulder Paving Surcharge - 0 to 100 Tons	TON	\$20.00
West Virginia Paving, Inc - Camden Materials	J2	Asphalt Base I Shoulder Paving Surcharge - 101 to 200 Tons	TON	\$15.00
West Virginia Paving, Inc - Camden Materials	J3	Asphalt Base I Shoulder Paving Surcharge - 201 to 500 Tons	TON	\$4.00
West Virginia Paving, Inc - Camden Materials	J4	Asphalt Base I Shoulder Paving Surcharge - 501 Tons or Greater	TON	\$2.00
West Virginia Paving, Inc - Camden Materials	K1	Asphalt Base II Shoulder Paving Surcharge - 0 to 100 Tons	TON	\$20.00
West Virginia Paving, Inc - Camden Materials	K2	Asphalt Base II Shoulder Paving Surcharge - 101 to 200 Tons	TON	\$15.00
West Virginia Paving, Inc - Camden Materials	K3	Asphalt Base II Shoulder Paving Surcharge - 201 to 500 Tons	TON	\$4.00
West Virginia Paving, Inc - Camden Materials	K4	Asphalt Base II Shoulder Paving Surcharge - 501 Tons or Greater	TON	\$2.00
West Virginia Paving, Inc - Camden Materials	L	Asphalt Material for Tack Coat or Prime Material	GAL	\$2.50
West Virginia Paving, Inc - Camden Materials	M	Additional Heel-In Joints	LF	\$12.00
West Virginia Paving, Inc - Camden Materials	N	Skip Paving Surcharge	TON	\$4.50
West Virginia Paving, Inc - Camden Materials	O1	Pavement Profiling/Milling-WVDOH Owns Millings 0 to 250 Sq. Yards	SY	\$20.85
West Virginia Paving, Inc - Camden Materials	O2	Pavement Profiling/Milling-WVDOH Owns Millings 251 to 500 Sq. Yards	SY	\$15.85
West Virginia Paving, Inc - Camden Materials	O3	Pavement Profiling/Milling-WVDOH Owns Millings 501 to 1000 Sq. Yards	SY	\$10.85
West Virginia Paving, Inc - Camden Materials	O4	Pavement Profiling/Milling-WVDOH Owns Millings 1001 to 2500 Sq. Yards	SY	\$5.85
West Virginia Paving, Inc - Camden Materials	O5	Pavement Profiling/Milling-WVDOH Owns Millings 2501 to 5000 Sq. Yards	SY	\$3.95
West Virginia Paving, Inc - Camden Materials	O6	Pavement Profiling/Milling-WVDOH Owns Millings 5001 Sq. Yards or Greater	SY	\$2.85
West Virginia Paving, Inc - Camden Materials	P1	Pavement Profiling/Milling-Vendor Owns Millings 0 to 250 Sq. Yards	SY	\$20.45
West Virginia Paving, Inc - Camden Materials	P2	Pavement Profiling/Milling-Vendor Owns Millings 251 to 500 Sq. Yards	SY	\$15.45
West Virginia Paving, Inc - Camden Materials	P3	Pavement Profiling/Milling-Vendor Owns Millings 501 to 1000 Sq. Yards	SY	\$10.45
West Virginia Paving, Inc - Camden Materials	P4	Pavement Profiling/Milling-Vendor Owns Millings 1001 to 2500 Sq. Yards	SY	\$5.45
West Virginia Paving, Inc - Camden Materials	P5	Pavement Profiling/Milling-Vendor Owns Millings 2501 to 5000 Sq. Yards	SY	\$3.55
West Virginia Paving, Inc - Camden Materials	P6	Pavement Profiling/Milling-Vendor Owns Millings 5001 Sq. Yards or Greater	SY	\$2.45
	Q	Mobilization - Pavement Profiling/Milling - Complete on Attachment B (ATT B)	LUMP SUM	-----

Asphalt Materials Delivery & Labor by Vendor by County

ATTACHMENT A PRICING PAGE (ATT A)

Vendor name shall be entered here by the Vendor: West Virginia Paving, Inc. - Camden Materials

Vendor Instructions: For bidding, Vendor shall mark with an "X" the counties that correspond with the pricing on this page. If Vendor has varied pricing per county, Vendor shall complete a separate set of Pricing Pages (ATT A and ATT B) as well as separate Plant Information Forms (ATT C & ATT D) for each county pricing set. Vendor must complete TWO Pricing Pages (ATT A and ATT B) as well as all Plant Information Forms for each pricing set submitted.

<input type="checkbox"/> Barbour	<input type="checkbox"/> Doddridge	<input type="checkbox"/> Harrison	<input type="checkbox"/> Marshall	<input type="checkbox"/> Morgan	<input type="checkbox"/> Raleigh	<input type="checkbox"/> Upshur
<input type="checkbox"/> Berkeley	<input type="checkbox"/> Fayette	<input checked="" type="checkbox"/> Jackson	<input type="checkbox"/> Mason	<input type="checkbox"/> Nicholas	<input type="checkbox"/> Randolph	<input type="checkbox"/> Wayne
<input type="checkbox"/> Boone	<input type="checkbox"/> Gilmer	<input type="checkbox"/> Jefferson	<input type="checkbox"/> McDowell	<input type="checkbox"/> Ohio	<input checked="" type="checkbox"/> Ritchie	<input type="checkbox"/> Webster
<input type="checkbox"/> Braxton	<input type="checkbox"/> Grant	<input type="checkbox"/> Kanawha	<input type="checkbox"/> Mercer	<input type="checkbox"/> Pendleton	<input checked="" type="checkbox"/> Roane	<input type="checkbox"/> Wetzel
<input type="checkbox"/> Brooke	<input type="checkbox"/> Greenbrier	<input type="checkbox"/> Lewis	<input type="checkbox"/> Mineral	<input checked="" type="checkbox"/> Pleasants	<input type="checkbox"/> Summers	<input checked="" type="checkbox"/> Wirt
<input type="checkbox"/> Cabell	<input type="checkbox"/> Hampshire	<input type="checkbox"/> Lincoln	<input type="checkbox"/> Mingo	<input type="checkbox"/> Pocahontas	<input type="checkbox"/> Taylor	<input checked="" type="checkbox"/> Wood
<input checked="" type="checkbox"/> Calhoun	<input type="checkbox"/> Hancock	<input type="checkbox"/> Logan	<input type="checkbox"/> Monongalia	<input type="checkbox"/> Preston	<input type="checkbox"/> Tucker	<input type="checkbox"/> Wyoming
<input type="checkbox"/> Clay	<input type="checkbox"/> Hardy	<input type="checkbox"/> Marion	<input type="checkbox"/> Monroe	<input type="checkbox"/> Putnam	<input type="checkbox"/> Tyler	STATEWIDE

Supplier Name - Vendor's Sourced Plant	Contract Item #	Contract Item Description	Unit of Measure	List Price
West Virginia Paving, Inc - Camden Materials	R1	Haul of Profiled/Milled Cuttings, First 10 Miles (Included with Contract Items O & P)	MILE	No Add'l Charge
West Virginia Paving, Inc - Camden Materials	R2	Haul of Profiled/Milled Cuttings, Each Additional Mile (Above 10 Miles)	LOADED MILE	\$4.80
West Virginia Paving, Inc - Camden Materials	S	Pavement Repair - Asphalt Base II	TON	\$325.00
West Virginia Paving, Inc - Camden Materials	T	Asphalt HPTO - SP496 - PG 64E-22 ordered 400 Ton increments	TON	No Bid
West Virginia Paving, Inc - Camden Materials	U	Non-Tracking Tack - to be used with T	GAL	No Bid
West Virginia Paving, Inc - Camden Materials	V	Lay Down of Materials - to be used with T - 400 Ton or Greater	TON	No Bid
West Virginia Paving, Inc - Camden Materials	W	Ultra-Thin Asphalt Overlay - SP498	TON	No Bid
West Virginia Paving, Inc - Camden Materials	X1	Fine Milling of Asphalt Pavement Surfaces - 0 to 250 Sq. Yards	SY	\$22.85
West Virginia Paving, Inc - Camden Materials	X2	Fine Milling of Asphalt Pavement Surfaces - 251 to 500 Sq. Yards	SY	\$17.85
West Virginia Paving, Inc - Camden Materials	X3	Fine Milling of Asphalt Pavement Surfaces - 501 to 1000 Sq. Yards	SY	\$12.85
West Virginia Paving, Inc - Camden Materials	X4	Fine Milling of Asphalt Pavement Surfaces 1001 to 2500 Sq. Yards	SY	\$6.70
West Virginia Paving, Inc - Camden Materials	X5	Fine Milling of Asphalt Pavement Surfaces 2501 to 5000 Sq. Yards	SY	\$4.85
West Virginia Paving, Inc - Camden Materials	X6	Fine Milling of Asphalt Pavement Surfaces - 5001 SY or Greater	SY	\$3.05
West Virginia Paving, Inc - Camden Materials	Y	Milled Rumble Strips	LF	\$0.50
	Z	Mobilization - Milled Rumble Strips - Complete on Attachment B (ATT B)	LUMP SUM	
West Virginia Paving, Inc - Camden Materials	AA	Surcharge for Parking Lot and Facility Paving - Items A	TON	\$7.00
West Virginia Paving, Inc - Camden Materials	AB	Cleaning and Sweeping	SY	\$0.01
West Virginia Paving, Inc - Camden Materials	AC1	Maintaining Traffic - Pilot Truck and Driver	DAY	\$900.00
West Virginia Paving, Inc - Camden Materials	AC2	Maintaining Traffic - Traffic Control Devices	UNIT	\$1.00
West Virginia Paving, Inc - Camden Materials	AC3	Maintaining Traffic - Flagger	HOUR	\$66.00
West Virginia Paving, Inc - Camden Materials	AC4	Maintaining Traffic - Arrow Board	DAY	\$30.00
West Virginia Paving, Inc - Camden Materials	AD1	Off-Season Plant Opening - First Day	DAY	No Bid
West Virginia Paving, Inc - Camden Materials	AD2	Off-Season Plant Opening - Each Additional Day	DAY	No Bid

Total Number of **Attachment A** pages submitted by Vendor is: 14

Asphalt Materials Delivery & Labor by Vendor by County

ATTACHMENT A PRICING PAGE (ATT A)

Vendor name shall be entered here by the Vendor: West Virginia Paving, Inc. - Ashland, KY

Vendor Instructions: For bidding, Vendor shall mark with an "X" the counties that correspond with the pricing on this page. If Vendor has varied pricing per county, Vendor shall complete a separate set of Pricing Pages (ATT A and ATT B) as well as separate Plant Information Forms (ATT C & ATT D) for each county pricing set. Vendor must complete TWO Pricing Pages (ATT A and ATT B) as well as all Plant Information Forms for each pricing set submitted.

<input type="checkbox"/> Barbour	<input type="checkbox"/> Doddridge	<input type="checkbox"/> Harrison	<input type="checkbox"/> Marshall	<input type="checkbox"/> Morgan	<input type="checkbox"/> Raleigh	<input type="checkbox"/> Upshur
<input type="checkbox"/> Berkeley	<input type="checkbox"/> Fayette	<input type="checkbox"/> Jackson	<input type="checkbox"/> Mason	<input type="checkbox"/> Nicholas	<input type="checkbox"/> Randolph	<input checked="" type="checkbox"/> Wayne
<input type="checkbox"/> Boone	<input type="checkbox"/> Gilmer	<input type="checkbox"/> Jefferson	<input type="checkbox"/> McDowell	<input type="checkbox"/> Ohio	<input type="checkbox"/> Ritchie	<input type="checkbox"/> Webster
<input type="checkbox"/> Braxton	<input type="checkbox"/> Grant	<input type="checkbox"/> Kanawha	<input type="checkbox"/> Mercer	<input type="checkbox"/> Pendleton	<input type="checkbox"/> Roane	<input type="checkbox"/> Wetzel
<input type="checkbox"/> Brooke	<input type="checkbox"/> Greenbrier	<input type="checkbox"/> Lewis	<input type="checkbox"/> Mineral	<input type="checkbox"/> Pleasants	<input type="checkbox"/> Summers	<input type="checkbox"/> Wirt
<input checked="" type="checkbox"/> Cabell	<input type="checkbox"/> Hampshire	<input checked="" type="checkbox"/> Lincoln	<input type="checkbox"/> Mingo	<input type="checkbox"/> Pocahontas	<input type="checkbox"/> Taylor	<input type="checkbox"/> Wood
<input type="checkbox"/> Calhoun	<input type="checkbox"/> Hancock	<input type="checkbox"/> Logan	<input type="checkbox"/> Monongalia	<input type="checkbox"/> Preston	<input type="checkbox"/> Tucker	<input type="checkbox"/> Wyoming
<input type="checkbox"/> Clay	<input type="checkbox"/> Hardy	<input type="checkbox"/> Marion	<input type="checkbox"/> Monroe	<input type="checkbox"/> Putnam	<input type="checkbox"/> Tyler	<input type="checkbox"/> STATEWIDE

Supplier Name - Vendor's Sourced Plant	Contract Item #	Contract Item Description	Unit of Measure	List Price
West Virginia Paving, Inc - Ashland, KY Plant		Asphalt Section 401 - Base I	TON	No Bid
West Virginia Paving, Inc - Ashland, KY Plant	A2	Asphalt Section 401 - 25mm Superpave	TON	No Bid
West Virginia Paving, Inc - Ashland, KY Plant	A3	Asphalt Section 401 - Base II	TON	\$68.00
West Virginia Paving, Inc - Ashland, KY Plant	A4	Asphalt Section 401 - Patch and Level	TON	\$68.00
West Virginia Paving, Inc - Ashland, KY Plant	A5	Asphalt Section 401 - Wearing IV	TON	\$70.00
West Virginia Paving, Inc - Ashland, KY Plant	A6	Asphalt Section 402 - Wearing IV	TON	No Bid
West Virginia Paving, Inc - Ashland, KY Plant	A7	Asphalt Section 401 - 19mm Superpave	TON	No Bid
West Virginia Paving, Inc - Ashland, KY Plant	A8	Asphalt Section 401 - Scratch Course	TON	\$74.00
West Virginia Paving, Inc - Ashland, KY Plant	A9	Asphalt Section 402 - 9.5mm Superpave	TON	No Bid
West Virginia Paving, Inc - Ashland, KY Plant	A10	Asphalt Section 401 - Wearing 1	TON	\$74.00
West Virginia Paving, Inc - Ashland, KY Plant	A11	Asphalt Section 402 - Wearing 1	TON	No Bid
West Virginia Paving, Inc - Ashland, KY Plant	A12	Asphalt Section 401 - 4.75mm Superpave	TON	No Bid
West Virginia Paving, Inc - Ashland, KY Plant	A13	Asphalt Section 402 - 4.75mm Superpave	TON	No Bid
West Virginia Paving, Inc - Ashland, KY Plant	A14	Asphalt Section 401 - Wearing III	TON	No Bid
West Virginia Paving, Inc - Ashland, KY Plant	A15	Asphalt Section 402 - Wearing III	TON	No Bid
West Virginia Paving, Inc - Ashland, KY Plant	A16	Asphalt Section 401 - 12.5mm Superpave	TON	No Bid
West Virginia Paving, Inc - Ashland, KY Plant	A17	Asphalt Section 402 - 12.5mm Superpave	TON	No Bid
West Virginia Paving, Inc - Ashland, KY Plant	B	Shoulder Stone Placement for Asphalt Section 307 - Class 10	TON	\$57.00
	C	Shoulder Stone Mobilization - Complete on Attachment B (ATT B)	LUMP SUM	-----
West Virginia Paving, Inc - Ashland, KY Plant	D1	Haul by Vendor Shoulder Stone Placement - First Ton Mile	MILE	\$1.50
West Virginia Paving, Inc - Ashland, KY Plant	D2	Haul by Vendor Shoulder Stone Placement - Each Additional Mile	MILE	\$0.24
West Virginia Paving, Inc - Ashland, KY Plant	E1	Surcharge for PG Binder - 70 minus 22	TON	\$4.00
West Virginia Paving, Inc - Ashland, KY Plant	E2	Surcharge for PG Binder 76 minus 22 ordered in 400 Ton increments	TON	\$12.00
West Virginia Paving, Inc - Ashland, KY Plant	F1	Asphalt Haul by Vendor - First Ton Mile	MILE	\$1.50
West Virginia Paving, Inc - Ashland, KY Plant	F2	Asphalt Haul by Vendor - Each Additional Mile	MILE	\$0.20
West Virginia Paving, Inc - Ashland, KY Plant	G1	Laydown of Materials. Items A and V, Each Site 0 to 100 Tons	TON	\$65.00
West Virginia Paving, Inc - Ashland, KY Plant	G2	Laydown of Materials. Items A and V, Each Site 101 to 200 Tons	TON	\$26.00
West Virginia Paving, Inc - Ashland, KY Plant	G3	Laydown of Materials. Items A and V, Each Site 201 to 500 Tons	TON	\$11.00
West Virginia Paving, Inc - Ashland, KY Plant	G4	Laydown of Materials. Items A and V, Each Site 501 Tons or Greater	TON	\$8.50
	H1	Mobilization - Daytime Paving - Complete on Attachment B (ATT B)	LUMP SUM	-----
	H2	Mobilization - Nighttime Paving - Complete on Attachment B (ATT B)	LUMP SUM	-----
West Virginia Paving, Inc - Ashland, KY Plant	I1	Excavation for Shoulder Paving - 0 to 1000 Sq. Yards	SY	\$5.75
West Virginia Paving, Inc - Ashland, KY Plant	I2	Excavation for Shoulder Paving - 1001 to 2000 Sq. Yards	SY	\$3.75
West Virginia Paving, Inc - Ashland, KY Plant	I3	Excavation for Shoulder Paving - 2001 to 3000 Sq. Yards	SY	\$2.75
West Virginia Paving, Inc - Ashland, KY Plant	I4	Excavation for Shoulder Paving - 3001 Sq. Yards or Greater	SY	\$1.75
West Virginia Paving, Inc - Ashland, KY Plant	J1	Asphalt Base I Shoulder Paving Surcharge - 0 to 100 Tons	TON	\$20.00
West Virginia Paving, Inc - Ashland, KY Plant	J2	Asphalt Base I Shoulder Paving Surcharge - 101 to 200 Tons	TON	\$15.00
West Virginia Paving, Inc - Ashland, KY Plant	J3	Asphalt Base I Shoulder Paving Surcharge - 201 to 500 Tons	TON	\$4.00
West Virginia Paving, Inc - Ashland, KY Plant	J4	Asphalt Base I Shoulder Paving Surcharge - 501 Tons or Greater	TON	\$2.00
West Virginia Paving, Inc - Ashland, KY Plant	K1	Asphalt Base II Shoulder Paving Surcharge - 0 to 100 Tons	TON	\$20.00
West Virginia Paving, Inc - Ashland, KY Plant	K2	Asphalt Base II Shoulder Paving Surcharge - 101 to 200 Tons	TON	\$15.00
West Virginia Paving, Inc - Ashland, KY Plant	K3	Asphalt Base II Shoulder Paving Surcharge - 201 to 500 Tons	TON	\$4.00
West Virginia Paving, Inc - Ashland, KY Plant	K4	Asphalt Base II Shoulder Paving Surcharge - 501 Tons or Greater	TON	\$2.00
West Virginia Paving, Inc - Ashland, KY Plant	L	Asphalt Material for Tack Coat or Prime Material	GAL	\$2.50
West Virginia Paving, Inc - Ashland, KY Plant	M	Additional Heel-In Joints	LF	\$12.00
West Virginia Paving, Inc - Ashland, KY Plant	N	Skip Paving Surcharge	TON	\$4.50
West Virginia Paving, Inc - Ashland, KY Plant	O1	Pavement Profiling/Milling-WVDOH Owns Millings 0 to 250 Sq. Yards	SY	\$20.85
West Virginia Paving, Inc - Ashland, KY Plant	O2	Pavement Profiling/Milling-WVDOH Owns Millings 251 to 500 Sq. Yards	SY	\$15.85
West Virginia Paving, Inc - Ashland, KY Plant	O3	Pavement Profiling/Milling-WVDOH Owns Millings 501 to 1000 Sq. Yards	SY	\$10.85
West Virginia Paving, Inc - Ashland, KY Plant	O4	Pavement Profiling/Milling-WVDOH Owns Millings 1001 to 2500 Sq. Yards	SY	\$5.85
West Virginia Paving, Inc - Ashland, KY Plant	O5	Pavement Profiling/Milling-WVDOH Owns Millings 2501 to 5000 Sq. Yards	SY	\$3.95
West Virginia Paving, Inc - Ashland, KY Plant	O6	Pavement Profiling/Milling-WVDOH Owns Millings 5001 Sq. Yards or Greater	SY	\$2.85
West Virginia Paving, Inc - Ashland, KY Plant	P1	Pavement Profiling/Milling-Vendor Owns Millings 0 to 250 Sq. Yards	SY	\$20.45
West Virginia Paving, Inc - Ashland, KY Plant	P2	Pavement Profiling/Milling-Vendor Owns Millings 251 to 500 Sq. Yards	SY	\$15.45
West Virginia Paving, Inc - Ashland, KY Plant	P3	Pavement Profiling/Milling-Vendor Owns Millings 501 to 1000 Sq. Yards	SY	\$10.45
West Virginia Paving, Inc - Ashland, KY Plant	P4	Pavement Profiling/Milling-Vendor Owns Millings 1001 to 2500 Sq. Yards	SY	\$5.45
West Virginia Paving, Inc - Ashland, KY Plant	P5	Pavement Profiling/Milling-Vendor Owns Millings 2501 to 5000 Sq. Yards	SY	\$3.55
West Virginia Paving, Inc - Ashland, KY Plant	P6	Pavement Profiling/Milling-Vendor Owns Millings 5001 Sq. Yards or Greater	SY	\$2.45
	Q	Mobilization - Pavement Profiling/Milling - Complete on Attachment B (ATT B)	LUMP SUM	-----

Asphalt Materials Delivery & Labor by Vendor by County

ATTACHMENT A PRICING PAGE (ATT A)

Vendor name shall be entered here by the Vendor: West Virginia Paving, Inc. - Ashland, KY

Vendor Instructions: For bidding, Vendor shall mark with an "X" the counties that correspond with the pricing on this page. If Vendor has varied pricing per county, Vendor shall complete a separate set of Pricing Pages (ATT A and ATT B) as well as separate Plant Information Forms (ATT C & ATT D) for each county pricing set. Vendor must complete TWO Pricing Pages (ATT A and ATT B) as well as all Plant Information Forms for each pricing set submitted.

<input type="checkbox"/> Barbour	<input type="checkbox"/> Doddridge	<input type="checkbox"/> Harrison	<input type="checkbox"/> Marshall	<input type="checkbox"/> Morgan	<input type="checkbox"/> Raleigh	<input type="checkbox"/> Upshur
<input type="checkbox"/> Berkeley	<input type="checkbox"/> Fayette	<input type="checkbox"/> Jackson	<input type="checkbox"/> Mason	<input type="checkbox"/> Nicholas	<input type="checkbox"/> Randolph	<input checked="" type="checkbox"/> Wayne
<input type="checkbox"/> Boone	<input type="checkbox"/> Gilmer	<input type="checkbox"/> Jefferson	<input type="checkbox"/> McDowell	<input type="checkbox"/> Ohio	<input type="checkbox"/> Ritchie	<input type="checkbox"/> Webster
<input type="checkbox"/> Braxton	<input type="checkbox"/> Grant	<input type="checkbox"/> Kanawha	<input type="checkbox"/> Mercer	<input type="checkbox"/> Pendleton	<input type="checkbox"/> Roane	<input type="checkbox"/> Wetzel
<input type="checkbox"/> Brooke	<input type="checkbox"/> Greenbrier	<input type="checkbox"/> Lewis	<input type="checkbox"/> Mineral	<input type="checkbox"/> Pleasants	<input type="checkbox"/> Summers	<input type="checkbox"/> Wirt
<input checked="" type="checkbox"/> Cabell	<input type="checkbox"/> Hampshire	<input checked="" type="checkbox"/> Lincoln	<input type="checkbox"/> Mingo	<input type="checkbox"/> Pocahontas	<input type="checkbox"/> Taylor	<input type="checkbox"/> Wood
<input type="checkbox"/> Calhoun	<input type="checkbox"/> Hancock	<input type="checkbox"/> Logan	<input type="checkbox"/> Monongalia	<input type="checkbox"/> Preston	<input type="checkbox"/> Tucker	<input type="checkbox"/> Wyoming
<input type="checkbox"/> Clay	<input type="checkbox"/> Hardy	<input type="checkbox"/> Marion	<input type="checkbox"/> Monroe	<input type="checkbox"/> Putnam	<input type="checkbox"/> Tyler	<input type="checkbox"/> STATEWIDE

Supplier Name - Vendor's Sourced Plant	Contract Item #	Contract Item Description	Unit of Measure	List Price
West Virginia Paving, Inc - Ashland, KY Plant	R1	Haul of Profiled/Milled Cuttings, First 10 Miles (Included with Contract Items O & P)	MILE	No Add'l Charge
West Virginia Paving, Inc - Ashland, KY Plant	R2	Haul of Profiled/Milled Cuttings, Each Additional Mile (Above 10 Miles)	LOADED MILE	\$4.80
West Virginia Paving, Inc - Ashland, KY Plant	S	Pavement Repair - Asphalt Base II	TON	\$325.00
West Virginia Paving, Inc - Ashland, KY Plant	T	Asphalt HPTO - SP496 - PG 64E-22 ordered 400 Ton increments	TON	No Bid
West Virginia Paving, Inc - Ashland, KY Plant	U	Non-Tracking Tack - to be used with T	GAL	No Bid
West Virginia Paving, Inc - Ashland, KY Plant	V	Lay Down of Materials - to be used with T - 400 Ton or Greater	TON	No Bid
West Virginia Paving, Inc - Ashland, KY Plant	W	Ultra-Thin Asphalt Overlay - SP498	TON	No Bid
West Virginia Paving, Inc - Ashland, KY Plant	X1	Fine Milling of Asphalt Pavement Surfaces - 0 to 250 Sq. Yards	SY	\$22.85
West Virginia Paving, Inc - Ashland, KY Plant	X2	Fine Milling of Asphalt Pavement Surfaces - 251 to 500 Sq. Yards	SY	\$17.85
West Virginia Paving, Inc - Ashland, KY Plant	X3	Fine Milling of Asphalt Pavement Surfaces - 501 to 1000 Sq. Yards	SY	\$12.85
West Virginia Paving, Inc - Ashland, KY Plant	X4	Fine Milling of Asphalt Pavement Surfaces 1001 to 2500 Sq. Yards	SY	\$6.70
West Virginia Paving, Inc - Ashland, KY Plant	X5	Fine Milling of Asphalt Pavement Surfaces 2501 to 5000 Sq. Yards	SY	\$4.85
West Virginia Paving, Inc - Ashland, KY Plant	X6	Fine Milling of Asphalt Pavement Surfaces - 5001 SY or Greater	SY	\$3.05
West Virginia Paving, Inc - Ashland, KY Plant	Y	Milled Rumble Strips	LF	\$0.50
	Z	Mobilization - Milled Rumble Strips - Complete on Attachment B (ATT B)	LUMP SUM	
West Virginia Paving, Inc - Ashland, KY Plant	AA	Surcharge for Parking Lot and Facility Paving - Items A	TON	\$7.00
West Virginia Paving, Inc - Ashland, KY Plant	AB	Cleaning and Sweeping	SY	\$0.01
West Virginia Paving, Inc - Ashland, KY Plant	AC1	Maintaining Traffic - Pilot Truck and Driver	DAY	\$900.00
West Virginia Paving, Inc - Ashland, KY Plant	AC2	Maintaining Traffic - Traffic Control Devices	UNIT	\$1.00
West Virginia Paving, Inc - Ashland, KY Plant	AC3	Maintaining Traffic - Flagger	HOUR	\$66.00
West Virginia Paving, Inc - Ashland, KY Plant	AC4	Maintaining Traffic - Arrow Board	DAY	\$30.00
West Virginia Paving, Inc - Ashland, KY Plant	AD1	Off-Season Plant Opening - First Day	DAY	\$3,500.00
West Virginia Paving, Inc - Ashland, KY Plant	AD2	Off-Season Plant Opening - Each Additional Day	DAY	\$1,000.00

Total Number of Attachment A pages submitted by Vendor is: 14

Asphalt Materials Delivery & Labor by Vendor by County

ATTACHMENT A PRICING PAGE (ATT A)

Vendor name shall be entered here by the Vendor: West Virginia Paving, Inc. - Camden Materials

Vendor Instructions: For bidding, Vendor shall mark with an "X" the counties that correspond with the pricing on this page. If Vendor has varied pricing per county, Vendor shall complete a separate set of Pricing Pages (ATT A and ATT B) as well as separate Plant Information Forms (ATT C & ATT D) for each county pricing set. Vendor must complete TWO Pricing Pages (ATT A and ATT B) as well as all Plant Information Forms for each pricing set submitted.

<input type="checkbox"/> Barbour	<input type="checkbox"/> Doddridge	<input type="checkbox"/> Harrison	<input type="checkbox"/> Marshall	<input type="checkbox"/> Morgan	<input type="checkbox"/> Raleigh	<input type="checkbox"/> Upshur
<input type="checkbox"/> Berkeley	<input type="checkbox"/> Fayette	<input checked="" type="checkbox"/> Jackson	<input type="checkbox"/> Mason	<input type="checkbox"/> Nicholas	<input type="checkbox"/> Randolph	<input type="checkbox"/> Wayne
<input type="checkbox"/> Boone	<input type="checkbox"/> Gilmer	<input type="checkbox"/> Jefferson	<input type="checkbox"/> McDowell	<input type="checkbox"/> Ohio	<input checked="" type="checkbox"/> Ritchie	<input type="checkbox"/> Webster
<input type="checkbox"/> Braxton	<input type="checkbox"/> Grant	<input type="checkbox"/> Kanawha	<input type="checkbox"/> Mercer	<input type="checkbox"/> Pendleton	<input checked="" type="checkbox"/> Roane	<input type="checkbox"/> Wetzel
<input type="checkbox"/> Brooke	<input type="checkbox"/> Greenbrier	<input type="checkbox"/> Lewis	<input type="checkbox"/> Mineral	<input checked="" type="checkbox"/> Pleasants	<input type="checkbox"/> Summers	<input checked="" type="checkbox"/> Wirt
<input type="checkbox"/> Cabell	<input type="checkbox"/> Hampshire	<input type="checkbox"/> Lincoln	<input type="checkbox"/> Mingo	<input type="checkbox"/> Pocahontas	<input type="checkbox"/> Taylor	<input checked="" type="checkbox"/> Wood
<input checked="" type="checkbox"/> Calhoun	<input type="checkbox"/> Hancock	<input type="checkbox"/> Logan	<input type="checkbox"/> Monongalia	<input type="checkbox"/> Preston	<input type="checkbox"/> Tucker	<input type="checkbox"/> Wyoming
<input type="checkbox"/> Clay	<input type="checkbox"/> Hardy	<input type="checkbox"/> Marion	<input type="checkbox"/> Monroe	<input type="checkbox"/> Putnam	<input type="checkbox"/> Tyler	STATEWIDE

Supplier Name - Vendor's Sourced Plant	Contract Item #	Contract Item Description	Unit of Measure	List Price
West Virginia Paving, Inc - Camden Materials		Asphalt Section 401 - Base I	TON	No Bid
West Virginia Paving, Inc - Camden Materials	A2	Asphalt Section 401 - 25mm Superpave	TON	No Bid
West Virginia Paving, Inc - Camden Materials	A3	Asphalt Section 401 - Base II	TON	No Bid
West Virginia Paving, Inc - Camden Materials	A4	Asphalt Section 401 - Patch and Level	TON	No Bid
West Virginia Paving, Inc - Camden Materials	A5	Asphalt Section 401 - Wearing IV	TON	No Bid
West Virginia Paving, Inc - Camden Materials	A6	Asphalt Section 402 - Wearing IV	TON	No Bid
West Virginia Paving, Inc - Camden Materials	A7	Asphalt Section 401 - 19mm Superpave	TON	No Bid
West Virginia Paving, Inc - Camden Materials	A8	Asphalt Section 401 - Scratch Course	TON	No Bid
West Virginia Paving, Inc - Camden Materials	A9	Asphalt Section 402 - 9.5mm Superpave	TON	No Bid
West Virginia Paving, Inc - Camden Materials	A10	Asphalt Section 401 - Wearing 1	TON	No Bid
West Virginia Paving, Inc - Camden Materials	A11	Asphalt Section 402 - Wearing 1	TON	No Bid
West Virginia Paving, Inc - Camden Materials	A12	Asphalt Section 401 - 4.75mm Superpave	TON	No Bid
West Virginia Paving, Inc - Camden Materials	A13	Asphalt Section 402 - 4.75mm Superpave	TON	No Bid
West Virginia Paving, Inc - Camden Materials	A14	Asphalt Section 401 - Wearing III	TON	No Bid
West Virginia Paving, Inc - Camden Materials	A15	Asphalt Section 402 - Wearing III	TON	No Bid
West Virginia Paving, Inc - Camden Materials	A16	Asphalt Section 401 - 12.5mm Superpave	TON	No Bid
West Virginia Paving, Inc - Camden Materials	A17	Asphalt Section 402 - 12.5mm Superpave	TON	No Bid
West Virginia Paving, Inc - Camden Materials	B	Shoulder Stone Placement for Asphalt Section 307 - Class 10	TON	\$57.00
West Virginia Paving, Inc - Camden Materials	C	Shoulder Stone Mobilization - Complete on Attachment B (ATT B)	LUMP SUM	-----
West Virginia Paving, Inc - Camden Materials	D1	Haul by Vendor Shoulder Stone Placement - First Ton Mile	MILE	\$1.50
West Virginia Paving, Inc - Camden Materials	D2	Haul by Vendor Shoulder Stone Placement - Each Additional Mile	MILE	\$0.24
West Virginia Paving, Inc - Camden Materials	E1	Surcharge for PG Binder - 70 minus 22	TON	No Bid
West Virginia Paving, Inc - Camden Materials	E2	Surcharge for PG Binder 76 minus 22 ordered in 400 Ton increments	TON	No Bid
West Virginia Paving, Inc - Camden Materials	F1	Asphalt Haul by Vendor - First Ton Mile	MILE	\$1.50
West Virginia Paving, Inc - Camden Materials	F2	Asphalt Haul by Vendor - Each Additional Mile	MILE	\$0.21
West Virginia Paving, Inc - Camden Materials	G1	Laydown of Materials. Items A and V, Each Site 0 to 100 Tons	TON	\$65.00
West Virginia Paving, Inc - Camden Materials	G2	Laydown of Materials. Items A and V, Each Site 101 to 200 Tons	TON	\$26.00
West Virginia Paving, Inc - Camden Materials	G3	Laydown of Materials. Items A and V, Each Site 201 to 500 Tons	TON	\$11.00
West Virginia Paving, Inc - Camden Materials	G4	Laydown of Materials. Items A and V, Each Site 501 Tons or Greater	TON	\$8.50
West Virginia Paving, Inc - Camden Materials	H1	Mobilization - Daytime Paving - Complete on Attachment B (ATT B)	LUMP SUM	-----
West Virginia Paving, Inc - Camden Materials	H2	Mobilization - Nighttime Paving - Complete on Attachment B (ATT B)	LUMP SUM	-----
West Virginia Paving, Inc - Camden Materials	I1	Excavation for Shoulder Paving - 0 to 1000 Sq. Yards	SY	\$5.75
West Virginia Paving, Inc - Camden Materials	I2	Excavation for Shoulder Paving - 1001 to 2000 Sq. Yards	SY	\$3.75
West Virginia Paving, Inc - Camden Materials	I3	Excavation for Shoulder Paving - 2001 to 3000 Sq. Yards	SY	\$2.75
West Virginia Paving, Inc - Camden Materials	I4	Excavation for Shoulder Paving - 3001 Sq. Yards or Greater	SY	\$1.75
West Virginia Paving, Inc - Camden Materials	J1	Asphalt Base I Shoulder Paving Surcharge - 0 to 100 Tons	TON	\$20.00
West Virginia Paving, Inc - Camden Materials	J2	Asphalt Base I Shoulder Paving Surcharge - 101 to 200 Tons	TON	\$15.00
West Virginia Paving, Inc - Camden Materials	J3	Asphalt Base I Shoulder Paving Surcharge - 201 to 500 Tons	TON	\$4.00
West Virginia Paving, Inc - Camden Materials	J4	Asphalt Base I Shoulder Paving Surcharge - 501 Tons or Greater	TON	\$2.00
West Virginia Paving, Inc - Camden Materials	K1	Asphalt Base II Shoulder Paving Surcharge - 0 to 100 Tons	TON	\$20.00
West Virginia Paving, Inc - Camden Materials	K2	Asphalt Base II Shoulder Paving Surcharge - 101 to 200 Tons	TON	\$15.00
West Virginia Paving, Inc - Camden Materials	K3	Asphalt Base II Shoulder Paving Surcharge - 201 to 500 Tons	TON	\$4.00
West Virginia Paving, Inc - Camden Materials	K4	Asphalt Base II Shoulder Paving Surcharge - 501 Tons or Greater	TON	\$2.00
West Virginia Paving, Inc - Camden Materials	L	Asphalt Material for Tack Coat or Prime Material	GAL	\$2.50
West Virginia Paving, Inc - Camden Materials	M	Additional Heel-In Joints	LF	\$12.00
West Virginia Paving, Inc - Camden Materials	N	Skip Paving Surcharge	TON	\$4.50
West Virginia Paving, Inc - Camden Materials	O1	Pavement Profiling/Milling-WVDOH Owns Millings 0 to 250 Sq. Yards	SY	\$20.85
West Virginia Paving, Inc - Camden Materials	O2	Pavement Profiling/Milling-WVDOH Owns Millings 251 to 500 Sq. Yards	SY	\$15.85
West Virginia Paving, Inc - Camden Materials	O3	Pavement Profiling/Milling-WVDOH Owns Millings 501 to 1000 Sq. Yards	SY	\$10.85
West Virginia Paving, Inc - Camden Materials	O4	Pavement Profiling/Milling-WVDOH Owns Millings 1001 to 2500 Sq. Yards	SY	\$5.85
West Virginia Paving, Inc - Camden Materials	O5	Pavement Profiling/Milling-WVDOH Owns Millings 2501 to 5000 Sq. Yards	SY	\$3.95
West Virginia Paving, Inc - Camden Materials	O6	Pavement Profiling/Milling-WVDOH Owns Millings 5001 Sq. Yards or Greater	SY	\$2.85
West Virginia Paving, Inc - Camden Materials	P1	Pavement Profiling/Milling-Vendor Owns Millings 0 to 250 Sq. Yards	SY	\$20.45
West Virginia Paving, Inc - Camden Materials	P2	Pavement Profiling/Milling-Vendor Owns Millings 251 to 500 Sq. Yards	SY	\$15.45
West Virginia Paving, Inc - Camden Materials	P3	Pavement Profiling/Milling-Vendor Owns Millings 501 to 1000 Sq. Yards	SY	\$10.45
West Virginia Paving, Inc - Camden Materials	P4	Pavement Profiling/Milling-Vendor Owns Millings 1001 to 2500 Sq. Yards	SY	\$5.45
West Virginia Paving, Inc - Camden Materials	P5	Pavement Profiling/Milling-Vendor Owns Millings 2501 to 5000 Sq. Yards	SY	\$3.55
West Virginia Paving, Inc - Camden Materials	P6	Pavement Profiling/Milling-Vendor Owns Millings 5001 Sq. Yards or Greater	SY	\$2.45
West Virginia Paving, Inc - Camden Materials	Q	Mobilization - Pavement Profiling/Milling - Complete on Attachment B (ATT B)	LUMP SUM	-----

Asphalt Materials Delivery & Labor by Vendor by County

ATTACHMENT A PRICING PAGE (ATT A)

Vendor name shall be entered here by the Vendor: West Virginia Paving, Inc. - Camden Materials

Vendor Instructions: For bidding, Vendor shall mark with an "X" the counties that correspond with the pricing on this page. If Vendor has varied pricing per county, Vendor shall complete a separate set of Pricing Pages (ATT A and ATT B) as well as separate Plant Information Forms (ATT C & ATT D) for each county pricing set. Vendor must complete TWO Pricing Pages (ATT A and ATT B) as well as all Plant Information Forms for each pricing set submitted.

<input type="checkbox"/> Barbour	<input type="checkbox"/> Doddridge	<input type="checkbox"/> Harrison	<input type="checkbox"/> Marshall	<input type="checkbox"/> Morgan	<input type="checkbox"/> Raleigh	<input type="checkbox"/> Upshur
<input type="checkbox"/> Berkeley	<input type="checkbox"/> Fayette	<input checked="" type="checkbox"/> Jackson	<input type="checkbox"/> Mason	<input type="checkbox"/> Nicholas	<input type="checkbox"/> Randolph	<input type="checkbox"/> Wayne
<input type="checkbox"/> Boone	<input type="checkbox"/> Gilmer	<input type="checkbox"/> Jefferson	<input type="checkbox"/> McDowell	<input type="checkbox"/> Ohio	<input checked="" type="checkbox"/> Ritchie	<input type="checkbox"/> Webster
<input type="checkbox"/> Braxton	<input type="checkbox"/> Grant	<input type="checkbox"/> Kanawha	<input type="checkbox"/> Mercer	<input type="checkbox"/> Pendleton	<input checked="" type="checkbox"/> Roane	<input type="checkbox"/> Wetzel
<input type="checkbox"/> Brooke	<input type="checkbox"/> Greenbrier	<input type="checkbox"/> Lewis	<input type="checkbox"/> Mineral	<input checked="" type="checkbox"/> Pleasants	<input type="checkbox"/> Summers	<input checked="" type="checkbox"/> Wirt
<input type="checkbox"/> Cabell	<input type="checkbox"/> Hampshire	<input type="checkbox"/> Lincoln	<input type="checkbox"/> Mingo	<input type="checkbox"/> Pocahontas	<input type="checkbox"/> Taylor	<input checked="" type="checkbox"/> Wood
<input checked="" type="checkbox"/> Calhoun	<input type="checkbox"/> Hancock	<input type="checkbox"/> Logan	<input type="checkbox"/> Monongalia	<input type="checkbox"/> Preston	<input type="checkbox"/> Tucker	<input type="checkbox"/> Wyoming
<input type="checkbox"/> Clay	<input type="checkbox"/> Hardy	<input type="checkbox"/> Marion	<input type="checkbox"/> Monroe	<input type="checkbox"/> Putnam	<input type="checkbox"/> Tyler	STATEWIDE

Supplier Name - Vendor's Sourced Plant	Contract Item #	Contract Item Description	Unit of Measure	List Price
West Virginia Paving, Inc - Camden Materials	R1	Haul of Profiled/Milled Cuttings, First 10 Miles (Included with Contract Items O & P)	MILE	No Add'l Charge
West Virginia Paving, Inc - Camden Materials	R2	Haul of Profiled/Milled Cuttings, Each Additional Mile (Above 10 Miles)	LOADED MILE	\$4.80
West Virginia Paving, Inc - Camden Materials	S	Pavement Repair - Asphalt Base II	TON	\$325.00
West Virginia Paving, Inc - Camden Materials	T	Asphalt HPTO - SP496 - PG 64E-22 ordered 400 Ton increments	TON	No Bid
West Virginia Paving, Inc - Camden Materials	U	Non-Tracking Tack - to be used with T	GAL	No Bid
West Virginia Paving, Inc - Camden Materials	V	Lay Down of Materials - to be used with T - 400 Ton or Greater	TON	No Bid
West Virginia Paving, Inc - Camden Materials	W	Ultra-Thin Asphalt Overlay - SP498	TON	No Bid
West Virginia Paving, Inc - Camden Materials	X1	Fine Milling of Asphalt Pavement Surfaces - 0 to 250 Sq. Yards	SY	\$22.85
West Virginia Paving, Inc - Camden Materials	X2	Fine Milling of Asphalt Pavement Surfaces - 251 to 500 Sq. Yards	SY	\$17.85
West Virginia Paving, Inc - Camden Materials	X3	Fine Milling of Asphalt Pavement Surfaces - 501 to 1000 Sq. Yards	SY	\$12.85
West Virginia Paving, Inc - Camden Materials	X4	Fine Milling of Asphalt Pavement Surfaces 1001 to 2500 Sq. Yards	SY	\$6.70
West Virginia Paving, Inc - Camden Materials	X5	Fine Milling of Asphalt Pavement Surfaces 2501 to 5000 Sq. Yards	SY	\$4.85
West Virginia Paving, Inc - Camden Materials	X6	Fine Milling of Asphalt Pavement Surfaces - 5001 SY or Greater	SY	\$3.05
West Virginia Paving, Inc - Camden Materials	Y	Milled Rumble Strips	LF	\$0.50
	Z	Mobilization - Milled Rumble Strips - Complete on Attachment B (ATT B)	LUMP SUM	
West Virginia Paving, Inc - Camden Materials	AA	Surcharge for Parking Lot and Facility Paving - Items A	TON	\$7.00
West Virginia Paving, Inc - Camden Materials	AB	Cleaning and Sweeping	SY	\$0.01
West Virginia Paving, Inc - Camden Materials	AC1	Maintaining Traffic - Pilot Truck and Driver	DAY	\$900.00
West Virginia Paving, Inc - Camden Materials	AC2	Maintaining Traffic - Traffic Control Devices	UNIT	\$1.00
West Virginia Paving, Inc - Camden Materials	AC3	Maintaining Traffic - Flagger	HOUR	\$66.00
West Virginia Paving, Inc - Camden Materials	AC4	Maintaining Traffic - Arrow Board	DAY	\$30.00
West Virginia Paving, Inc - Camden Materials	AD1	Off-Season Plant Opening - First Day	DAY	No Bid
West Virginia Paving, Inc - Camden Materials	AD2	Off-Season Plant Opening - Each Additional Day	DAY	No Bid

Total Number of Attachment A pages submitted by Vendor is: 14

Asphalt Materials Delivery & Labor by Vendor by County

ATTACHMENT A PRICING PAGE (ATT A)

Vendor name shall be entered here by the Vendor: West Virginia Paving, Inc. - Beaver, WV Plant

Vendor Instructions: For bidding, Vendor shall mark with an "X" the counties that correspond with the pricing on this page. If Vendor has varied pricing per county, Vendor shall complete a separate set of Pricing Pages (ATT A and ATT B) as well as separate Plant Information Forms (ATT C & ATT D) for each county pricing set. Vendor must complete TWO Pricing Pages (ATT A and ATT B) as well as all Plant Information Forms for each pricing set submitted.

<input type="checkbox"/> Barbour	<input type="checkbox"/> Doddridge	<input type="checkbox"/> Harrison	<input type="checkbox"/> Marshall	<input type="checkbox"/> Morgan	<input checked="" type="checkbox"/> Raleigh	<input type="checkbox"/> Upshur
<input type="checkbox"/> Berkeley	<input checked="" type="checkbox"/> Fayette	<input type="checkbox"/> Jackson	<input type="checkbox"/> Mason	<input type="checkbox"/> Nicholas	<input type="checkbox"/> Randolph	<input type="checkbox"/> Wayne
<input type="checkbox"/> Boone	<input type="checkbox"/> Gilmer	<input type="checkbox"/> Jefferson	<input checked="" type="checkbox"/> McDowell	<input type="checkbox"/> Ohio	<input type="checkbox"/> Ritchie	<input type="checkbox"/> Webster
<input type="checkbox"/> Braxton	<input type="checkbox"/> Grant	<input type="checkbox"/> Kanawha	<input checked="" type="checkbox"/> Mercer	<input type="checkbox"/> Pendleton	<input type="checkbox"/> Roane	<input type="checkbox"/> Wetzel
<input type="checkbox"/> Brooke	<input type="checkbox"/> Greenbrier	<input type="checkbox"/> Lewis	<input type="checkbox"/> Mineral	<input type="checkbox"/> Pleasants	<input checked="" type="checkbox"/> Summers	<input type="checkbox"/> Wirt
<input type="checkbox"/> Cabell	<input type="checkbox"/> Hampshire	<input type="checkbox"/> Lincoln	<input type="checkbox"/> Mingo	<input type="checkbox"/> Pocahontas	<input type="checkbox"/> Taylor	<input type="checkbox"/> Wood
<input type="checkbox"/> Calhoun	<input type="checkbox"/> Hancock	<input type="checkbox"/> Logan	<input type="checkbox"/> Monongalia	<input type="checkbox"/> Preston	<input type="checkbox"/> Tucker	<input checked="" type="checkbox"/> Wyoming
<input type="checkbox"/> Clay	<input type="checkbox"/> Hardy	<input type="checkbox"/> Marion	<input type="checkbox"/> Monroe	<input type="checkbox"/> Putnam	<input type="checkbox"/> Tyler	STATEWIDE

Supplier Name - Vendor's Sourced Plant	Contract Item #	Contract Item Description	Unit of Measure	List Price
West Virginia Paving, Inc - Beaver, WV Plant		Asphalt Section 401 - Base I	TON	\$69.75
West Virginia Paving, Inc - Beaver, WV Plant	A2	Asphalt Section 401 - 25mm Superpave	TON	\$73.50
West Virginia Paving, Inc - Beaver, WV Plant	A3	Asphalt Section 401 - Base II	TON	\$74.00
West Virginia Paving, Inc - Beaver, WV Plant	A4	Asphalt Section 401 - Patch and Level	TON	\$74.00
West Virginia Paving, Inc - Beaver, WV Plant	A5	Asphalt Section 401 - Wearing IV	TON	\$76.00
West Virginia Paving, Inc - Beaver, WV Plant	A6	Asphalt Section 402 - Wearing IV	TON	No Bid
West Virginia Paving, Inc - Beaver, WV Plant	A7	Asphalt Section 401 - 19mm Superpave	TON	\$76.00
West Virginia Paving, Inc - Beaver, WV Plant	A8	Asphalt Section 401 - Scratch Course	TON	\$78.00
West Virginia Paving, Inc - Beaver, WV Plant	A9	Asphalt Section 402 - 9.5mm Superpave	TON	\$81.00
West Virginia Paving, Inc - Beaver, WV Plant	A10	Asphalt Section 401 - Wearing 1	TON	\$78.00
West Virginia Paving, Inc - Beaver, WV Plant	A11	Asphalt Section 402 - Wearing 1	TON	\$81.00
West Virginia Paving, Inc - Beaver, WV Plant	A12	Asphalt Section 401 - 4.75mm Superpave	TON	No Bid
West Virginia Paving, Inc - Beaver, WV Plant	A13	Asphalt Section 402 - 4.75mm Superpave	TON	No Bid
West Virginia Paving, Inc - Beaver, WV Plant	A14	Asphalt Section 401 - Wearing III	TON	\$90.00
West Virginia Paving, Inc - Beaver, WV Plant	A15	Asphalt Section 402 - Wearing III	TON	No Bid
West Virginia Paving, Inc - Beaver, WV Plant	A16	Asphalt Section 401 - 12.5mm Superpave	TON	\$79.00
West Virginia Paving, Inc - Beaver, WV Plant	A17	Asphalt Section 402 - 12.5mm Superpave	TON	\$79.00
West Virginia Paving, Inc - Beaver, WV Plant	B	Shoulder Stone Placement for Asphalt Section 307 - Class 10	TON	\$52.00
	C	Shoulder Stone Mobilization - Complete on Attachment B (ATT B)	LUMP SUM	-----
West Virginia Paving, Inc - Beaver, WV Plant	D1	Haul by Vendor Shoulder Stone Placement - First Ton Mile	MILE	\$1.50
West Virginia Paving, Inc - Beaver, WV Plant	D2	Haul by Vendor Shoulder Stone Placement - Each Additional Mile	MILE	\$0.24
West Virginia Paving, Inc - Beaver, WV Plant	E1	Surcharge for PG Binder - 70 minus 22	TON	\$4.00
West Virginia Paving, Inc - Beaver, WV Plant	E2	Surcharge for PG Binder 76 minus 22 ordered in 400 Ton increments	TON	\$12.00
West Virginia Paving, Inc - Beaver, WV Plant	F1	Asphalt Haul by Vendor - First Ton Mile	MILE	\$1.50
West Virginia Paving, Inc - Beaver, WV Plant	F2	Asphalt Haul by Vendor - Each Additional Mile	MILE	\$0.21
West Virginia Paving, Inc - Beaver, WV Plant	G1	Laydown of Materials. Items A and V, Each Site 0 to 100 Tons	TON	\$65.00
West Virginia Paving, Inc - Beaver, WV Plant	G2	Laydown of Materials. Items A and V, Each Site 101 to 200 Tons	TON	\$26.00
West Virginia Paving, Inc - Beaver, WV Plant	G3	Laydown of Materials. Items A and V, Each Site 201 to 500 Tons	TON	\$11.00
West Virginia Paving, Inc - Beaver, WV Plant	G4	Laydown of Materials. Items A and V, Each Site 501 Tons or Greater	TON	\$8.50
	H1	Mobilization - Daytime Paving - Complete on Attachment B (ATT B)	LUMP SUM	-----
	H2	Mobilization - Nighttime Paving - Complete on Attachment B (ATT B)	LUMP SUM	-----
West Virginia Paving, Inc - Beaver, WV Plant	I1	Excavation for Shoulder Paving - 0 to 1000 Sq. Yards	SY	\$5.75
West Virginia Paving, Inc - Beaver, WV Plant	I2	Excavation for Shoulder Paving - 1001 to 2000 Sq. Yards	SY	\$3.75
West Virginia Paving, Inc - Beaver, WV Plant	I3	Excavation for Shoulder Paving - 2001 to 3000 Sq. Yards	SY	\$2.75
West Virginia Paving, Inc - Beaver, WV Plant	I4	Excavation for Shoulder Paving - 3001 Sq. Yards or Greater	SY	\$1.75
West Virginia Paving, Inc - Beaver, WV Plant	J1	Asphalt Base I Shoulder Paving Surcharge - 0 to 100 Tons	TON	\$20.00
West Virginia Paving, Inc - Beaver, WV Plant	J2	Asphalt Base I Shoulder Paving Surcharge - 101 to 200 Tons	TON	\$15.00
West Virginia Paving, Inc - Beaver, WV Plant	J3	Asphalt Base I Shoulder Paving Surcharge - 201 to 500 Tons	TON	\$4.00
West Virginia Paving, Inc - Beaver, WV Plant	J4	Asphalt Base I Shoulder Paving Surcharge - 501 Tons or Greater	TON	\$2.00
West Virginia Paving, Inc - Beaver, WV Plant	K1	Asphalt Base II Shoulder Paving Surcharge - 0 to 100 Tons	TON	\$20.00
West Virginia Paving, Inc - Beaver, WV Plant	K2	Asphalt Base II Shoulder Paving Surcharge - 101 to 200 Tons	TON	\$15.00
West Virginia Paving, Inc - Beaver, WV Plant	K3	Asphalt Base II Shoulder Paving Surcharge - 201 to 500 Tons	TON	\$4.00
West Virginia Paving, Inc - Beaver, WV Plant	K4	Asphalt Base II Shoulder Paving Surcharge - 501 Tons or Greater	TON	\$2.00
West Virginia Paving, Inc - Beaver, WV Plant	L	Asphalt Material for Tack Coat or Prime Material	GAL	\$2.50
West Virginia Paving, Inc - Beaver, WV Plant	M	Additional Heel-In Joints	LF	\$12.00
West Virginia Paving, Inc - Beaver, WV Plant	N	Skip Paving Surcharge	TON	\$4.50
West Virginia Paving, Inc - Beaver, WV Plant	O1	Pavement Profiling/Milling-WVDOH Owns Millings 0 to 250 Sq. Yards	SY	\$20.85
West Virginia Paving, Inc - Beaver, WV Plant	O2	Pavement Profiling/Milling-WVDOH Owns Millings 251 to 500 Sq. Yards	SY	\$15.85
West Virginia Paving, Inc - Beaver, WV Plant	O3	Pavement Profiling/Milling-WVDOH Owns Millings 501 to 1000 Sq. Yards	SY	\$10.85
West Virginia Paving, Inc - Beaver, WV Plant	O4	Pavement Profiling/Milling-WVDOH Owns Millings 1001 to 2500 Sq. Yards	SY	\$5.85
West Virginia Paving, Inc - Beaver, WV Plant	O5	Pavement Profiling/Milling-WVDOH Owns Millings 2501 to 5000 Sq. Yards	SY	\$3.95
West Virginia Paving, Inc - Beaver, WV Plant	O6	Pavement Profiling/Milling-WVDOH Owns Millings 5001 Sq. Yards or Greater	SY	\$2.85
West Virginia Paving, Inc - Beaver, WV Plant	P1	Pavement Profiling/Milling-Vendor Owns Millings 0 to 250 Sq. Yards	SY	\$20.45
West Virginia Paving, Inc - Beaver, WV Plant	P2	Pavement Profiling/Milling-Vendor Owns Millings 251 to 500 Sq. Yards	SY	\$15.45
West Virginia Paving, Inc - Beaver, WV Plant	P3	Pavement Profiling/Milling-Vendor Owns Millings 501 to 1000 Sq. Yards	SY	\$10.45
West Virginia Paving, Inc - Beaver, WV Plant	P4	Pavement Profiling/Milling-Vendor Owns Millings 1001 to 2500 Sq. Yards	SY	\$5.45
West Virginia Paving, Inc - Beaver, WV Plant	P5	Pavement Profiling/Milling-Vendor Owns Millings 2501 to 5000 Sq. Yards	SY	\$3.55
West Virginia Paving, Inc - Beaver, WV Plant	P6	Pavement Profiling/Milling-Vendor Owns Millings 5001 Sq. Yards or Greater	SY	\$2.45
	Q	Mobilization - Pavement Profiling/Milling - Complete on Attachment B (ATT B)	LUMP SUM	-----

Asphalt Materials Delivery & Labor by Vendor by County

ATTACHMENT A PRICING PAGE (ATT A)

Vendor name shall be entered here by the Vendor: West Virginia Paving, Inc. - Beaver, WV Plant

Vendor Instructions: For bidding, Vendor shall mark with an "X" the counties that correspond with the pricing on this page. If Vendor has varied pricing per county, Vendor shall complete a separate set of Pricing Pages (ATT A and ATT B) as well as separate Plant Information Forms (ATT C & ATT D) for each county pricing set. Vendor must complete TWO Pricing Pages (ATT A and ATT B) as well as all Plant Information Forms for each pricing set submitted.

<input type="checkbox"/> Barbour	<input type="checkbox"/> Doddridge	<input type="checkbox"/> Harrison	<input type="checkbox"/> Marshall	<input type="checkbox"/> Morgan	<input checked="" type="checkbox"/> Raleigh	<input type="checkbox"/> Upshur
<input type="checkbox"/> Berkeley	<input checked="" type="checkbox"/> Fayette	<input type="checkbox"/> Jackson	<input type="checkbox"/> Mason	<input type="checkbox"/> Nicholas	<input type="checkbox"/> Randolph	<input type="checkbox"/> Wayne
<input type="checkbox"/> Boone	<input type="checkbox"/> Gilmer	<input type="checkbox"/> Jefferson	<input checked="" type="checkbox"/> McDowell	<input type="checkbox"/> Ohio	<input type="checkbox"/> Ritchie	<input type="checkbox"/> Webster
<input type="checkbox"/> Braxton	<input type="checkbox"/> Grant	<input type="checkbox"/> Kanawha	<input checked="" type="checkbox"/> Mercer	<input type="checkbox"/> Pendleton	<input type="checkbox"/> Roane	<input type="checkbox"/> Wetzel
<input type="checkbox"/> Brooke	<input type="checkbox"/> Greenbrier	<input type="checkbox"/> Lewis	<input type="checkbox"/> Mineral	<input type="checkbox"/> Pleasants	<input checked="" type="checkbox"/> Summers	<input type="checkbox"/> Wirt
<input type="checkbox"/> Cabell	<input type="checkbox"/> Hampshire	<input type="checkbox"/> Lincoln	<input type="checkbox"/> Mingo	<input type="checkbox"/> Pocahontas	<input type="checkbox"/> Taylor	<input type="checkbox"/> Wood
<input type="checkbox"/> Calhoun	<input type="checkbox"/> Hancock	<input type="checkbox"/> Logan	<input type="checkbox"/> Monongalia	<input type="checkbox"/> Preston	<input type="checkbox"/> Tucker	<input checked="" type="checkbox"/> Wyoming
<input type="checkbox"/> Clay	<input type="checkbox"/> Hardy	<input type="checkbox"/> Marion	<input type="checkbox"/> Monroe	<input type="checkbox"/> Putnam	<input type="checkbox"/> Tyler	STATEWIDE

Supplier Name - Vendor's Sourced Plant	Contract Item #	Contract Item Description	Unit of Measure	List Price
West Virginia Paving, Inc - Beaver, WV Plant	R1	Haul of Profiled/Milled Cuttings, First 10 Miles (Included with Contract Items O & P)	MILE	No Add'l Charge
West Virginia Paving, Inc - Beaver, WV Plant	R2	Haul of Profiled/Milled Cuttings, Each Additional Mile (Above 10 Miles)	LOADED MILE	\$4.80
West Virginia Paving, Inc - Beaver, WV Plant	S	Pavement Repair - Asphalt Base II	TON	\$325.00
West Virginia Paving, Inc - Beaver, WV Plant	T	Asphalt HPTO - SP496 - PG 64E-22 ordered 400 Ton increments	TON	No Bid
West Virginia Paving, Inc - Beaver, WV Plant	U	Non-Tracking Tack - to be used with T	GAL	No Bid
West Virginia Paving, Inc - Beaver, WV Plant	V	Lay Down of Materials - to be used with T - 400 Ton or Greater	TON	No Bid
West Virginia Paving, Inc - Beaver, WV Plant	W	Ultra-Thin Asphalt Overlay - SP498	TON	No Bid
West Virginia Paving, Inc - Beaver, WV Plant	X1	Fine Milling of Asphalt Pavement Surfaces - 0 to 250 Sq. Yards	SY	\$22.85
West Virginia Paving, Inc - Beaver, WV Plant	X2	Fine Milling of Asphalt Pavement Surfaces - 251 to 500 Sq. Yards	SY	\$17.85
West Virginia Paving, Inc - Beaver, WV Plant	X3	Fine Milling of Asphalt Pavement Surfaces - 501 to 1000 Sq. Yards	SY	\$12.85
West Virginia Paving, Inc - Beaver, WV Plant	X4	Fine Milling of Asphalt Pavement Surfaces 1001 to 2500 Sq. Yards	SY	\$6.70
West Virginia Paving, Inc - Beaver, WV Plant	X5	Fine Milling of Asphalt Pavement Surfaces 2501 to 5000 Sq. Yards	SY	\$4.85
West Virginia Paving, Inc - Beaver, WV Plant	X6	Fine Milling of Asphalt Pavement Surfaces - 5001 SY or Greater	SY	\$3.05
West Virginia Paving, Inc - Beaver, WV Plant	Y	Milled Rumble Strips	LF	\$0.50
	Z	Mobilization - Milled Rumble Strips - Complete on Attachment B (ATT B)	LUMP SUM	
West Virginia Paving, Inc - Beaver, WV Plant	AA	Surcharge for Parking Lot and Facility Paving - Items A	TON	\$7.00
West Virginia Paving, Inc - Beaver, WV Plant	AB	Cleaning and Sweeping	SY	\$0.01
West Virginia Paving, Inc - Beaver, WV Plant	AC1	Maintaining Traffic - Pilot Truck and Driver	DAY	\$900.00
West Virginia Paving, Inc - Beaver, WV Plant	AC2	Maintaining Traffic - Traffic Control Devices	UNIT	\$1.00
West Virginia Paving, Inc - Beaver, WV Plant	AC3	Maintaining Traffic - Flagger	HOUR	\$66.00
West Virginia Paving, Inc - Beaver, WV Plant	AC4	Maintaining Traffic - Arrow Board	DAY	\$30.00
West Virginia Paving, Inc - Beaver, WV Plant	AD1	Off-Season Plant Opening - First Day	DAY	\$3,500.00
West Virginia Paving, Inc - Beaver, WV Plant	AD2	Off-Season Plant Opening - Each Additional Day	DAY	\$1,000.00

Total Number of **Attachment A** pages submitted by Vendor is: 14

Asphalt Materials Delivery & Labor by Vendor by County

ATTACHMENT A PRICING PAGE (ATT A)

Vendor name shall be entered here by the Vendor: West Virginia Paving, Inc. - Huntington, WV Plant

Vendor Instructions: For bidding, Vendor shall mark with an "X" the counties that correspond with the pricing on this page. If Vendor has varied pricing per county, Vendor shall complete a separate set of Pricing Pages (ATT A and ATT B) as well as separate Plant Information Forms (ATT C & ATT D) for each county pricing set. Vendor must complete TWO Pricing Pages (ATT A and ATT B) as well as all Plant Information Forms for each pricing set submitted.

<input type="checkbox"/> Barbour	<input type="checkbox"/> Doddridge	<input type="checkbox"/> Harrison	<input type="checkbox"/> Marshall	<input type="checkbox"/> Morgan	<input type="checkbox"/> Raleigh	<input type="checkbox"/> Upshur
<input type="checkbox"/> Berkeley	<input type="checkbox"/> Fayette	<input type="checkbox"/> Jackson	<input checked="" type="checkbox"/> Mason	<input type="checkbox"/> Nicholas	<input type="checkbox"/> Randolph	<input checked="" type="checkbox"/> Wayne
<input type="checkbox"/> Boone	<input type="checkbox"/> Gilmer	<input type="checkbox"/> Jefferson	<input type="checkbox"/> McDowell	<input type="checkbox"/> Ohio	<input type="checkbox"/> Ritchie	<input type="checkbox"/> Webster
<input type="checkbox"/> Braxton	<input type="checkbox"/> Grant	<input type="checkbox"/> Kanawha	<input type="checkbox"/> Mercer	<input type="checkbox"/> Pendleton	<input type="checkbox"/> Roane	<input type="checkbox"/> Wetzel
<input type="checkbox"/> Brooke	<input type="checkbox"/> Greenbrier	<input type="checkbox"/> Lewis	<input type="checkbox"/> Mineral	<input type="checkbox"/> Pleasants	<input type="checkbox"/> Summers	<input type="checkbox"/> Wirt
<input checked="" type="checkbox"/> Cabell	<input type="checkbox"/> Hampshire	<input checked="" type="checkbox"/> Lincoln	<input type="checkbox"/> Mingo	<input type="checkbox"/> Pocahontas	<input type="checkbox"/> Taylor	<input type="checkbox"/> Wood
<input type="checkbox"/> Calhoun	<input type="checkbox"/> Hancock	<input type="checkbox"/> Logan	<input type="checkbox"/> Monongalia	<input type="checkbox"/> Preston	<input type="checkbox"/> Tucker	<input type="checkbox"/> Wyoming
<input type="checkbox"/> Clay	<input type="checkbox"/> Hardy	<input type="checkbox"/> Marion	<input type="checkbox"/> Monroe	<input type="checkbox"/> Putnam	<input type="checkbox"/> Tyler	<input type="checkbox"/> STATEWIDE

Supplier Name - Vendor's Sourced Plant	Contract Item #	Contract Item Description	Unit of Measure	List Price
West Virginia Paving, Inc - Huntington, WV Plant		Asphalt Section 401 - Base I	TON	\$68.00
West Virginia Paving, Inc - Huntington, WV Plant	A2	Asphalt Section 401 - 25mm Superpave	TON	\$68.00
West Virginia Paving, Inc - Huntington, WV Plant	A3	Asphalt Section 401 - Base II	TON	\$68.00
West Virginia Paving, Inc - Huntington, WV Plant	A4	Asphalt Section 401 - Patch and Level	TON	\$68.00
West Virginia Paving, Inc - Huntington, WV Plant	A5	Asphalt Section 401 - Wearing IV	TON	\$70.00
West Virginia Paving, Inc - Huntington, WV Plant	A6	Asphalt Section 402 - Wearing IV	TON	\$76.00
West Virginia Paving, Inc - Huntington, WV Plant	A7	Asphalt Section 401 - 19mm Superpave	TON	\$71.00
West Virginia Paving, Inc - Huntington, WV Plant	A8	Asphalt Section 401 - Scratch Course	TON	\$74.00
West Virginia Paving, Inc - Huntington, WV Plant	A9	Asphalt Section 402 - 9.5mm Superpave	TON	\$80.00
West Virginia Paving, Inc - Huntington, WV Plant	A10	Asphalt Section 401 - Wearing 1	TON	\$74.00
West Virginia Paving, Inc - Huntington, WV Plant	A11	Asphalt Section 402 - Wearing 1	TON	\$78.00
West Virginia Paving, Inc - Huntington, WV Plant	A12	Asphalt Section 401 - 4.75mm Superpave	TON	No Bid
West Virginia Paving, Inc - Huntington, WV Plant	A13	Asphalt Section 402 - 4.75mm Superpave	TON	No Bid
West Virginia Paving, Inc - Huntington, WV Plant	A14	Asphalt Section 401 - Wearing III	TON	No Bid
West Virginia Paving, Inc - Huntington, WV Plant	A15	Asphalt Section 402 - Wearing III	TON	No Bid
West Virginia Paving, Inc - Huntington, WV Plant	A16	Asphalt Section 401 - 12.5mm Superpave	TON	\$80.00
West Virginia Paving, Inc - Huntington, WV Plant	A17	Asphalt Section 402 - 12.5mm Superpave	TON	\$80.00
West Virginia Paving, Inc - Huntington, WV Plant	B	Shoulder Stone Placement for Asphalt Section 307 - Class 10	TON	\$57.00
-----	C	Shoulder Stone Mobilization - Complete on Attachment B (ATT B)	LUMP SUM	-----
West Virginia Paving, Inc - Huntington, WV Plant	D1	Haul by Vendor Shoulder Stone Placement - First Ton Mile	MILE	\$1.50
West Virginia Paving, Inc - Huntington, WV Plant	D2	Haul by Vendor Shoulder Stone Placement - Each Additional Mile	MILE	\$0.24
West Virginia Paving, Inc - Huntington, WV Plant	E1	Surcharge for PG Binder - 70 minus 22	TON	\$4.00
West Virginia Paving, Inc - Huntington, WV Plant	E2	Surcharge for PG Binder 76 minus 22 ordered in 400 Ton increments	TON	\$12.00
West Virginia Paving, Inc - Huntington, WV Plant	F1	Asphalt Haul by Vendor - First Ton Mile	MILE	\$1.50
West Virginia Paving, Inc - Huntington, WV Plant	F2	Asphalt Haul by Vendor - Each Additional Mile	MILE	\$0.20
West Virginia Paving, Inc - Huntington, WV Plant	G1	Laydown of Materials. Items A and V, Each Site 0 to 100 Tons	TON	\$65.00
West Virginia Paving, Inc - Huntington, WV Plant	G2	Laydown of Materials. Items A and V, Each Site 101 to 200 Tons	TON	\$26.00
West Virginia Paving, Inc - Huntington, WV Plant	G3	Laydown of Materials. Items A and V, Each Site 201 to 500 Tons	TON	\$11.00
West Virginia Paving, Inc - Huntington, WV Plant	G4	Laydown of Materials. Items A and V, Each Site 501 Tons or Greater	TON	\$8.50
-----	H1	Mobilization - Daytime Paving - Complete on Attachment B (ATT B)	LUMP SUM	-----
-----	H2	Mobilization - Nighttime Paving - Complete on Attachment B (ATT B)	LUMP SUM	-----
West Virginia Paving, Inc - Huntington, WV Plant	I1	Excavation for Shoulder Paving - 0 to 1000 Sq. Yards	SY	\$5.75
West Virginia Paving, Inc - Huntington, WV Plant	I2	Excavation for Shoulder Paving - 1001 to 2000 Sq. Yards	SY	\$3.75
West Virginia Paving, Inc - Huntington, WV Plant	I3	Excavation for Shoulder Paving - 2001 to 3000 Sq. Yards	SY	\$2.75
West Virginia Paving, Inc - Huntington, WV Plant	I4	Excavation for Shoulder Paving - 3001 Sq. Yards or Greater	SY	\$1.75
West Virginia Paving, Inc - Huntington, WV Plant	J1	Asphalt Base I Shoulder Paving Surcharge - 0 to 100 Tons	TON	\$20.00
West Virginia Paving, Inc - Huntington, WV Plant	J2	Asphalt Base I Shoulder Paving Surcharge - 101 to 200 Tons	TON	\$15.00
West Virginia Paving, Inc - Huntington, WV Plant	J3	Asphalt Base I Shoulder Paving Surcharge - 201 to 500 Tons	TON	\$4.00
West Virginia Paving, Inc - Huntington, WV Plant	J4	Asphalt Base I Shoulder Paving Surcharge - 501 Tons or Greater	TON	\$2.00
West Virginia Paving, Inc - Huntington, WV Plant	K1	Asphalt Base II Shoulder Paving Surcharge - 0 to 100 Tons	TON	\$20.00
West Virginia Paving, Inc - Huntington, WV Plant	K2	Asphalt Base II Shoulder Paving Surcharge - 101 to 200 Tons	TON	\$15.00
West Virginia Paving, Inc - Huntington, WV Plant	K3	Asphalt Base II Shoulder Paving Surcharge - 201 to 500 Tons	TON	\$4.00
West Virginia Paving, Inc - Huntington, WV Plant	K4	Asphalt Base II Shoulder Paving Surcharge - 501 Tons or Greater	TON	\$2.00
West Virginia Paving, Inc - Huntington, WV Plant	L	Asphalt Material for Tack Coat or Prime Material	GAL	\$2.50
West Virginia Paving, Inc - Huntington, WV Plant	M	Additional Heel-In Joints	LF	\$12.00
West Virginia Paving, Inc - Huntington, WV Plant	N	Skip Paving Surcharge	TON	\$4.50
West Virginia Paving, Inc - Huntington, WV Plant	O1	Pavement Profiling/Milling-WVDOH Owns Millings 0 to 250 Sq. Yards	SY	\$20.85
West Virginia Paving, Inc - Huntington, WV Plant	O2	Pavement Profiling/Milling-WVDOH Owns Millings 251 to 500 Sq. Yards	SY	\$15.85
West Virginia Paving, Inc - Huntington, WV Plant	O3	Pavement Profiling/Milling-WVDOH Owns Millings 501 to 1000 Sq. Yards	SY	\$10.85
West Virginia Paving, Inc - Huntington, WV Plant	O4	Pavement Profiling/Milling-WVDOH Owns Millings 1001 to 2500 Sq. Yards	SY	\$5.85
West Virginia Paving, Inc - Huntington, WV Plant	O5	Pavement Profiling/Milling-WVDOH Owns Millings 2501 to 5000 Sq. Yards	SY	\$3.95
West Virginia Paving, Inc - Huntington, WV Plant	O6	Pavement Profiling/Milling-WVDOH Owns Millings 5001 Sq. Yards or Greater	SY	\$2.85
West Virginia Paving, Inc - Huntington, WV Plant	P1	Pavement Profiling/Milling-Vendor Owns Millings 0 to 250 Sq. Yards	SY	\$20.45
West Virginia Paving, Inc - Huntington, WV Plant	P2	Pavement Profiling/Milling-Vendor Owns Millings 251 to 500 Sq. Yards	SY	\$15.45
West Virginia Paving, Inc - Huntington, WV Plant	P3	Pavement Profiling/Milling-Vendor Owns Millings 501 to 1000 Sq. Yards	SY	\$10.45
West Virginia Paving, Inc - Huntington, WV Plant	P4	Pavement Profiling/Milling-Vendor Owns Millings 1001 to 2500 Sq. Yards	SY	\$5.45
West Virginia Paving, Inc - Huntington, WV Plant	P5	Pavement Profiling/Milling-Vendor Owns Millings 2501 to 5000 Sq. Yards	SY	\$3.55
West Virginia Paving, Inc - Huntington, WV Plant	P6	Pavement Profiling/Milling-Vendor Owns Millings 5001 Sq. Yards or Greater	SY	\$2.45
-----	Q	Mobilization - Pavement Profiling/Milling - Complete on Attachment B (ATT B)	LUMP SUM	-----

Asphalt Materials Delivery & Labor by Vendor by County

ATTACHMENT A PRICING PAGE (ATT A)

Vendor name shall be entered here by the Vendor: West Virginia Paving, Inc. - Huntington, WV Plant

Vendor Instructions: For bidding, Vendor shall mark with an "X" the counties that correspond with the pricing on this page. If Vendor has varied pricing per county, Vendor shall complete a separate set of Pricing Pages (ATT A and ATT B) as well as separate Plant Information Forms (ATT C & ATT D) for each county pricing set. Vendor must complete TWO Pricing Pages (ATT A and ATT B) as well as all Plant Information Forms for each pricing set submitted.

<input type="checkbox"/> Barbour	<input type="checkbox"/> Doddridge	<input type="checkbox"/> Harrison	<input type="checkbox"/> Marshall	<input type="checkbox"/> Morgan	<input type="checkbox"/> Raleigh	<input type="checkbox"/> Upshur
<input type="checkbox"/> Berkeley	<input type="checkbox"/> Fayette	<input type="checkbox"/> Jackson	<input checked="" type="checkbox"/> Mason	<input type="checkbox"/> Nicholas	<input type="checkbox"/> Randolph	<input checked="" type="checkbox"/> Wayne
<input type="checkbox"/> Boone	<input type="checkbox"/> Gilmer	<input type="checkbox"/> Jefferson	<input type="checkbox"/> McDowell	<input type="checkbox"/> Ohio	<input type="checkbox"/> Ritchie	<input type="checkbox"/> Webster
<input type="checkbox"/> Braxton	<input type="checkbox"/> Grant	<input type="checkbox"/> Kanawha	<input type="checkbox"/> Mercer	<input type="checkbox"/> Pendleton	<input type="checkbox"/> Roane	<input type="checkbox"/> Wetzel
<input type="checkbox"/> Brooke	<input type="checkbox"/> Greenbrier	<input type="checkbox"/> Lewis	<input type="checkbox"/> Mineral	<input type="checkbox"/> Pleasants	<input type="checkbox"/> Summers	<input type="checkbox"/> Wirt
<input checked="" type="checkbox"/> Cabell	<input type="checkbox"/> Hampshire	<input checked="" type="checkbox"/> Lincoln	<input type="checkbox"/> Mingo	<input type="checkbox"/> Pocahontas	<input type="checkbox"/> Taylor	<input type="checkbox"/> Wood
<input type="checkbox"/> Calhoun	<input type="checkbox"/> Hancock	<input type="checkbox"/> Logan	<input type="checkbox"/> Monongalia	<input type="checkbox"/> Preston	<input type="checkbox"/> Tucker	<input type="checkbox"/> Wyoming
<input type="checkbox"/> Clay	<input type="checkbox"/> Hardy	<input type="checkbox"/> Marion	<input type="checkbox"/> Monroe	<input type="checkbox"/> Putnam	<input type="checkbox"/> Tyler	<input type="checkbox"/> STATEWIDE

Supplier Name - Vendor's Sourced Plant	Contract Item #	Contract Item Description	Unit of Measure	List Price
West Virginia Paving, Inc - Huntington, WV Plant	R1	Haul of Profiled/Milled Cuttings, First 10 Miles (Included with Contract Items O & P)	MILE	No Add'l Charge
West Virginia Paving, Inc - Huntington, WV Plant	R2	Haul of Profiled/Milled Cuttings, Each Additional Mile (Above 10 Miles)	LOADED MILE	\$4.80
West Virginia Paving, Inc - Huntington, WV Plant	S	Pavement Repair - Asphalt Base II	TON	\$325.00
West Virginia Paving, Inc - Huntington, WV Plant	T	Asphalt HPTO - SP496 - PG 64E-22 ordered 400 Ton increments	TON	No Bid
West Virginia Paving, Inc - Huntington, WV Plant	U	Non-Tracking Tack - to be used with T	GAL	No Bid
West Virginia Paving, Inc - Huntington, WV Plant	V	Lay Down of Materials - to be used with T - 400 Ton or Greater	TON	No Bid
West Virginia Paving, Inc - Huntington, WV Plant	W	Ultra-Thin Asphalt Overlay - SP498	TON	No Bid
West Virginia Paving, Inc - Huntington, WV Plant	X1	Fine Milling of Asphalt Pavement Surfaces - 0 to 250 Sq. Yards	SY	\$22.85
West Virginia Paving, Inc - Huntington, WV Plant	X2	Fine Milling of Asphalt Pavement Surfaces - 251 to 500 Sq. Yards	SY	\$17.85
West Virginia Paving, Inc - Huntington, WV Plant	X3	Fine Milling of Asphalt Pavement Surfaces - 501 to 1000 Sq. Yards	SY	\$12.85
West Virginia Paving, Inc - Huntington, WV Plant	X4	Fine Milling of Asphalt Pavement Surfaces 1001 to 2500 Sq. Yards	SY	\$6.70
West Virginia Paving, Inc - Huntington, WV Plant	X5	Fine Milling of Asphalt Pavement Surfaces 2501 to 5000 Sq. Yards	SY	\$4.85
West Virginia Paving, Inc - Huntington, WV Plant	X6	Fine Milling of Asphalt Pavement Surfaces - 5001 SY or Greater	SY	\$3.05
West Virginia Paving, Inc - Huntington, WV Plant	Y	Milled Rumble Strips	LF	\$0.50
	Z	Mobilization - Milled Rumble Strips - Complete on Attachment B (ATT B)	LUMP SUM	
West Virginia Paving, Inc - Huntington, WV Plant	AA	Surcharge for Parking Lot and Facility Paving - Items A	TON	\$7.00
West Virginia Paving, Inc - Huntington, WV Plant	AB	Cleaning and Sweeping	SY	\$0.01
West Virginia Paving, Inc - Huntington, WV Plant	AC1	Maintaining Traffic - Pilot Truck and Driver	DAY	\$900.00
West Virginia Paving, Inc - Huntington, WV Plant	AC2	Maintaining Traffic - Traffic Control Devices	UNIT	\$1.00
West Virginia Paving, Inc - Huntington, WV Plant	AC3	Maintaining Traffic - Flagger	HOUR	\$66.00
West Virginia Paving, Inc - Huntington, WV Plant	AC4	Maintaining Traffic - Arrow Board	DAY	\$30.00
West Virginia Paving, Inc - Huntington, WV Plant	AD1	Off-Season Plant Opening - First Day	DAY	\$3,500.00
West Virginia Paving, Inc - Huntington, WV Plant	AD2	Off-Season Plant Opening - Each Additional Day	DAY	\$1,000.00

Total Number of Attachment A pages submitted by Vendor is: 14

Asphalt Materials Delivery & Labor by Vendor by County

ATTACHMENT A PRICING PAGE (ATT A)

Vendor name shall be entered here by the Vendor: West Virginia Paving, Inc. - Whitman, WV Plant

Vendor Instructions: For bidding, Vendor shall mark with an "X" the counties that correspond with the pricing on this page. If Vendor has varied pricing per county, Vendor shall complete a separate set of Pricing Pages (ATT A and ATT B) as well as separate Plant Information Forms (ATT C & ATT D) for each county pricing set. Vendor must complete TWO Pricing Pages (ATT A and ATT B) as well as all Plant Information Forms for each pricing set submitted.

<input type="checkbox"/> Barbour	<input type="checkbox"/> Doddridge	<input type="checkbox"/> Harrison	<input type="checkbox"/> Marshall	<input type="checkbox"/> Morgan	<input type="checkbox"/> Raleigh	<input type="checkbox"/> Upshur
<input type="checkbox"/> Berkeley	<input type="checkbox"/> Fayette	<input type="checkbox"/> Jackson	<input type="checkbox"/> Mason	<input type="checkbox"/> Nicholas	<input type="checkbox"/> Randolph	<input checked="" type="checkbox"/> Wayne
<input checked="" type="checkbox"/> Boone	<input type="checkbox"/> Gilmer	<input type="checkbox"/> Jefferson	<input checked="" type="checkbox"/> McDowell	<input type="checkbox"/> Ohio	<input type="checkbox"/> Ritchie	<input type="checkbox"/> Webster
<input type="checkbox"/> Braxton	<input type="checkbox"/> Grant	<input type="checkbox"/> Kanawha	<input type="checkbox"/> Mercer	<input type="checkbox"/> Pendleton	<input type="checkbox"/> Roane	<input type="checkbox"/> Wetzel
<input type="checkbox"/> Brooke	<input type="checkbox"/> Greenbrier	<input type="checkbox"/> Lewis	<input type="checkbox"/> Mineral	<input type="checkbox"/> Pleasants	<input type="checkbox"/> Summers	<input type="checkbox"/> Wirt
<input type="checkbox"/> Cabell	<input type="checkbox"/> Hampshire	<input checked="" type="checkbox"/> Lincoln	<input checked="" type="checkbox"/> Mingo	<input type="checkbox"/> Pocahontas	<input type="checkbox"/> Taylor	<input type="checkbox"/> Wood
<input type="checkbox"/> Calhoun	<input type="checkbox"/> Hancock	<input checked="" type="checkbox"/> Logan	<input type="checkbox"/> Monongalia	<input type="checkbox"/> Preston	<input type="checkbox"/> Tucker	<input checked="" type="checkbox"/> Wyoming
<input type="checkbox"/> Clay	<input type="checkbox"/> Hardy	<input type="checkbox"/> Marion	<input type="checkbox"/> Monroe	<input type="checkbox"/> Putnam	<input type="checkbox"/> Tyler	STATEWIDE

Supplier Name - Vendor's Sourced Plant	Contract Item #	Contract Item Description	Unit of Measure	List Price
West Virginia Paving, Inc - Whitman, WV Plant		Asphalt Section 401 - Base I	TON	\$79.50
West Virginia Paving, Inc - Whitman, WV Plant	A2	Asphalt Section 401 - 25mm Superpave	TON	\$83.00
West Virginia Paving, Inc - Whitman, WV Plant	A3	Asphalt Section 401 - Base II	TON	\$87.50
West Virginia Paving, Inc - Whitman, WV Plant	A4	Asphalt Section 401 - Patch and Level	TON	\$87.50
West Virginia Paving, Inc - Whitman, WV Plant	A5	Asphalt Section 401 - Wearing IV	TON	\$89.00
West Virginia Paving, Inc - Whitman, WV Plant	A6	Asphalt Section 402 - Wearing IV	TON	\$89.00
West Virginia Paving, Inc - Whitman, WV Plant	A7	Asphalt Section 401 - 19mm Superpave	TON	\$85.00
West Virginia Paving, Inc - Whitman, WV Plant	A8	Asphalt Section 401 - Scratch Course	TON	\$93.00
West Virginia Paving, Inc - Whitman, WV Plant	A9	Asphalt Section 402 - 9.5mm Superpave	TON	\$94.00
West Virginia Paving, Inc - Whitman, WV Plant	A10	Asphalt Section 401 - Wearing 1	TON	\$93.00
West Virginia Paving, Inc - Whitman, WV Plant	A11	Asphalt Section 402 - Wearing 1	TON	\$94.00
West Virginia Paving, Inc - Whitman, WV Plant	A12	Asphalt Section 401 - 4.75mm Superpave	TON	No Bid
West Virginia Paving, Inc - Whitman, WV Plant	A13	Asphalt Section 402 - 4.75mm Superpave	TON	No Bid
West Virginia Paving, Inc - Whitman, WV Plant	A14	Asphalt Section 401 - Wearing III	TON	No Bid
West Virginia Paving, Inc - Whitman, WV Plant	A15	Asphalt Section 402 - Wearing III	TON	No Bid
West Virginia Paving, Inc - Whitman, WV Plant	A16	Asphalt Section 401 - 12.5mm Superpave	TON	\$94.00
West Virginia Paving, Inc - Whitman, WV Plant	A17	Asphalt Section 402 - 12.5mm Superpave	TON	\$94.00
West Virginia Paving, Inc - Whitman, WV Plant	B	Shoulder Stone Placement for Asphalt Section 307 - Class 10	TON	\$57.00
-----	C	Shoulder Stone Mobilization - Complete on Attachment B (ATT B)	LUMP SUM	-----
West Virginia Paving, Inc - Whitman, WV Plant	D1	Haul by Vendor Shoulder Stone Placement - First Ton Mile	MILE	\$1.50
West Virginia Paving, Inc - Whitman, WV Plant	D2	Haul by Vendor Shoulder Stone Placement - Each Additional Mile	MILE	\$0.24
West Virginia Paving, Inc - Whitman, WV Plant	E1	Surcharge for PG Binder - 70 minus 22	TON	\$4.00
West Virginia Paving, Inc - Whitman, WV Plant	E2	Surcharge for PG Binder 76 minus 22 ordered in 400 Ton increments	TON	\$12.00
West Virginia Paving, Inc - Whitman, WV Plant	F1	Asphalt Haul by Vendor - First Ton Mile	MILE	\$1.50
West Virginia Paving, Inc - Whitman, WV Plant	F2	Asphalt Haul by Vendor - Each Additional Mile	MILE	\$0.21
West Virginia Paving, Inc - Whitman, WV Plant	G1	Laydown of Materials. Items A and V, Each Site 0 to 100 Tons	TON	\$65.00
West Virginia Paving, Inc - Whitman, WV Plant	G2	Laydown of Materials. Items A and V, Each Site 101 to 200 Tons	TON	\$26.00
West Virginia Paving, Inc - Whitman, WV Plant	G3	Laydown of Materials. Items A and V, Each Site 201 to 500 Tons	TON	\$11.00
West Virginia Paving, Inc - Whitman, WV Plant	G4	Laydown of Materials. Items A and V, Each Site 501 Tons or Greater	TON	\$8.50
-----	H1	Mobilization - Daytime Paving - Complete on Attachment B (ATT B)	LUMP SUM	-----
-----	H2	Mobilization - Nighttime Paving - Complete on Attachment B (ATT B)	LUMP SUM	-----
West Virginia Paving, Inc - Whitman, WV Plant	I1	Excavation for Shoulder Paving - 0 to 1000 Sq. Yards	SY	\$5.75
West Virginia Paving, Inc - Whitman, WV Plant	I2	Excavation for Shoulder Paving - 1001 to 2000 Sq. Yards	SY	\$3.75
West Virginia Paving, Inc - Whitman, WV Plant	I3	Excavation for Shoulder Paving - 2001 to 3000 Sq. Yards	SY	\$2.75
West Virginia Paving, Inc - Whitman, WV Plant	I4	Excavation for Shoulder Paving - 3001 Sq. Yards or Greater	SY	\$1.75
West Virginia Paving, Inc - Whitman, WV Plant	J1	Asphalt Base I Shoulder Paving Surcharge - 0 to 100 Tons	TON	\$20.00
West Virginia Paving, Inc - Whitman, WV Plant	J2	Asphalt Base I Shoulder Paving Surcharge - 101 to 200 Tons	TON	\$15.00
West Virginia Paving, Inc - Whitman, WV Plant	J3	Asphalt Base I Shoulder Paving Surcharge - 201 to 500 Tons	TON	\$4.00
West Virginia Paving, Inc - Whitman, WV Plant	J4	Asphalt Base I Shoulder Paving Surcharge - 501 Tons or Greater	TON	\$2.00
West Virginia Paving, Inc - Whitman, WV Plant	K1	Asphalt Base II Shoulder Paving Surcharge - 0 to 100 Tons	TON	\$20.00
West Virginia Paving, Inc - Whitman, WV Plant	K2	Asphalt Base II Shoulder Paving Surcharge - 101 to 200 Tons	TON	\$15.00
West Virginia Paving, Inc - Whitman, WV Plant	K3	Asphalt Base II Shoulder Paving Surcharge - 201 to 500 Tons	TON	\$4.00
West Virginia Paving, Inc - Whitman, WV Plant	K4	Asphalt Base II Shoulder Paving Surcharge - 501 Tons or Greater	TON	\$2.00
West Virginia Paving, Inc - Whitman, WV Plant	L	Asphalt Material for Tack Coat or Prime Material	GAL	\$2.50
West Virginia Paving, Inc - Whitman, WV Plant	M	Additional Heel-In Joints	LF	\$12.00
West Virginia Paving, Inc - Whitman, WV Plant	N	Skip Paving Surcharge	TON	\$4.50
West Virginia Paving, Inc - Whitman, WV Plant	O1	Pavement Profiling/Milling-WVDOH Owns Millings 0 to 250 Sq. Yards	SY	\$20.85
West Virginia Paving, Inc - Whitman, WV Plant	O2	Pavement Profiling/Milling-WVDOH Owns Millings 251 to 500 Sq. Yards	SY	\$15.85
West Virginia Paving, Inc - Whitman, WV Plant	O3	Pavement Profiling/Milling-WVDOH Owns Millings 501 to 1000 Sq. Yards	SY	\$10.85
West Virginia Paving, Inc - Whitman, WV Plant	O4	Pavement Profiling/Milling-WVDOH Owns Millings 1001 to 2500 Sq. Yards	SY	\$5.85
West Virginia Paving, Inc - Whitman, WV Plant	O5	Pavement Profiling/Milling-WVDOH Owns Millings 2501 to 5000 Sq. Yards	SY	\$3.95
West Virginia Paving, Inc - Whitman, WV Plant	O6	Pavement Profiling/Milling-WVDOH Owns Millings 5001 Sq. Yards or Greater	SY	\$2.85
West Virginia Paving, Inc - Whitman, WV Plant	P1	Pavement Profiling/Milling-Vendor Owns Millings 0 to 250 Sq. Yards	SY	\$20.45
West Virginia Paving, Inc - Whitman, WV Plant	P2	Pavement Profiling/Milling-Vendor Owns Millings 251 to 500 Sq. Yards	SY	\$15.45
West Virginia Paving, Inc - Whitman, WV Plant	P3	Pavement Profiling/Milling-Vendor Owns Millings 501 to 1000 Sq. Yards	SY	\$10.45
West Virginia Paving, Inc - Whitman, WV Plant	P4	Pavement Profiling/Milling-Vendor Owns Millings 1001 to 2500 Sq. Yards	SY	\$5.45
West Virginia Paving, Inc - Whitman, WV Plant	P5	Pavement Profiling/Milling-Vendor Owns Millings 2501 to 5000 Sq. Yards	SY	\$3.55
West Virginia Paving, Inc - Whitman, WV Plant	P6	Pavement Profiling/Milling-Vendor Owns Millings 5001 Sq. Yards or Greater	SY	\$2.45
-----	Q	Mobilization - Pavement Profiling/Milling - Complete on Attachment B (ATT B)	LUMP SUM	-----

Asphalt Materials Delivery & Labor by Vendor by County

ATTACHMENT A PRICING PAGE (ATT A)

Vendor name shall be entered here by the Vendor: West Virginia Paving, Inc. - Whitman. WV Plant

Vendor Instructions: For bidding, Vendor shall mark with an "X" the counties that correspond with the pricing on this page. If Vendor has varied pricing per county, Vendor shall complete a separate set of Pricing Pages (ATT A and ATT B) as well as separate Plant Information Forms (ATT C & ATT D) for each county pricing set. Vendor must complete TWO Pricing Pages (ATT A and ATT B) as well as all Plant Information Forms for each pricing set submitted.

<input type="checkbox"/> Barbour	<input type="checkbox"/> Doddridge	<input type="checkbox"/> Harrison	<input type="checkbox"/> Marshall	<input type="checkbox"/> Morgan	<input type="checkbox"/> Raleigh	<input type="checkbox"/> Upshur
<input type="checkbox"/> Berkeley	<input type="checkbox"/> Fayette	<input type="checkbox"/> Jackson	<input type="checkbox"/> Mason	<input type="checkbox"/> Nicholas	<input type="checkbox"/> Randolph	<input checked="" type="checkbox"/> Wayne
<input checked="" type="checkbox"/> Boone	<input type="checkbox"/> Gilmer	<input type="checkbox"/> Jefferson	<input checked="" type="checkbox"/> McDowell	<input type="checkbox"/> Ohio	<input type="checkbox"/> Ritchie	<input type="checkbox"/> Webster
<input type="checkbox"/> Braxton	<input type="checkbox"/> Grant	<input type="checkbox"/> Kanawha	<input type="checkbox"/> Mercer	<input type="checkbox"/> Pendleton	<input type="checkbox"/> Roane	<input type="checkbox"/> Wetzel
<input type="checkbox"/> Brooke	<input type="checkbox"/> Greenbrier	<input type="checkbox"/> Lewis	<input type="checkbox"/> Mineral	<input type="checkbox"/> Pleasants	<input type="checkbox"/> Summers	<input type="checkbox"/> Wirt
<input type="checkbox"/> Cabell	<input type="checkbox"/> Hampshire	<input checked="" type="checkbox"/> Lincoln	<input checked="" type="checkbox"/> Mingo	<input type="checkbox"/> Pocahontas	<input type="checkbox"/> Taylor	<input type="checkbox"/> Wood
<input type="checkbox"/> Calhoun	<input type="checkbox"/> Hancock	<input checked="" type="checkbox"/> Logan	<input type="checkbox"/> Monongalia	<input type="checkbox"/> Preston	<input type="checkbox"/> Tucker	<input checked="" type="checkbox"/> Wyoming
<input type="checkbox"/> Clay	<input type="checkbox"/> Hardy	<input type="checkbox"/> Marion	<input type="checkbox"/> Monroe	<input type="checkbox"/> Putnam	<input type="checkbox"/> Tyler	STATEWIDE

Supplier Name - Vendor's Sourced Plant	Contract Item #	Contract Item Description	Unit of Measure	List Price
West Virginia Paving, Inc - Whitman, WV Plant	R1	Haul of Profiled/Milled Cuttings, First 10 Miles (Included with Contract Items O & P)	MILE	No Add'l Charge
West Virginia Paving, Inc - Whitman, WV Plant	R2	Haul of Profiled/Milled Cuttings, Each Additional Mile (Above 10 Miles)	LOADED MILE	\$4.80
West Virginia Paving, Inc - Whitman, WV Plant	S	Pavement Repair - Asphalt Base II	TON	\$325.00
West Virginia Paving, Inc - Whitman, WV Plant	T	Asphalt HPTO - SP496 - PG 64E-22 ordered 400 Ton increments	TON	No Bid
West Virginia Paving, Inc - Whitman, WV Plant	U	Non-Tracking Tack - to be used with T	GAL	No Bid
West Virginia Paving, Inc - Whitman, WV Plant	V	Lay Down of Materials - to be used with T - 400 Ton or Greater	TON	No Bid
West Virginia Paving, Inc - Whitman, WV Plant	W	Ultra-Thin Asphalt Overlay - SP498	TON	No Bid
West Virginia Paving, Inc - Whitman, WV Plant	X1	Fine Milling of Asphalt Pavement Surfaces - 0 to 250 Sq. Yards	SY	\$22.85
West Virginia Paving, Inc - Whitman, WV Plant	X2	Fine Milling of Asphalt Pavement Surfaces - 251 to 500 Sq. Yards	SY	\$17.85
West Virginia Paving, Inc - Whitman, WV Plant	X3	Fine Milling of Asphalt Pavement Surfaces - 501 to 1000 Sq. Yards	SY	\$12.85
West Virginia Paving, Inc - Whitman, WV Plant	X4	Fine Milling of Asphalt Pavement Surfaces 1001 to 2500 Sq. Yards	SY	\$6.70
West Virginia Paving, Inc - Whitman, WV Plant	X5	Fine Milling of Asphalt Pavement Surfaces 2501 to 5000 Sq. Yards	SY	\$4.85
West Virginia Paving, Inc - Whitman, WV Plant	X6	Fine Milling of Asphalt Pavement Surfaces - 5001 SY or Greater	SY	\$3.05
West Virginia Paving, Inc - Whitman, WV Plant	Y	Milled Rumble Strips	LF	\$0.50
	Z	Mobilization - Milled Rumble Strips - Complete on Attachment B (ATT B)	LUMP SUM	
West Virginia Paving, Inc - Whitman, WV Plant	AA	Surcharge for Parking Lot and Facility Paving - Items A	TON	\$7.00
West Virginia Paving, Inc - Whitman, WV Plant	AB	Cleaning and Sweeping	SY	\$0.01
West Virginia Paving, Inc - Whitman, WV Plant	AC1	Maintaining Traffic - Pilot Truck and Driver	DAY	\$900.00
West Virginia Paving, Inc - Whitman, WV Plant	AC2	Maintaining Traffic - Traffic Control Devices	UNIT	\$1.00
West Virginia Paving, Inc - Whitman, WV Plant	AC3	Maintaining Traffic - Flagger	HOUR	\$66.00
West Virginia Paving, Inc - Whitman, WV Plant	AC4	Maintaining Traffic - Arrow Board	DAY	\$30.00
West Virginia Paving, Inc - Whitman, WV Plant	AD1	Off-Season Plant Opening - First Day	DAY	\$3,500.00
West Virginia Paving, Inc - Whitman, WV Plant	AD2	Off-Season Plant Opening - Each Additional Day	DAY	\$1,000.00

Total Number of **Attachment A** pages submitted by Vendor is: 14

Asphalt Materials Delivery & Labor by Vendor by County

ATTACHMENT A PRICING PAGE (ATT A)

Vendor name shall be entered here by the Vendor: West Virginia Paving, Inc. - Elkins, WV Plant

Vendor Instructions: For bidding, Vendor shall mark with an "X" the counties that correspond with the pricing on this page. If Vendor has varied pricing per county, Vendor shall complete a separate set of Pricing Pages (ATT A and ATT B) as well as separate Plant Information Forms (ATT C & ATT D) for each county pricing set. Vendor must complete TWO Pricing Pages (ATT A and ATT B) as well as all Plant Information Forms for each pricing set submitted.

<input checked="" type="checkbox"/> Barbour	<input type="checkbox"/> Doddridge	<input type="checkbox"/> Harrison	<input type="checkbox"/> Marshall	<input type="checkbox"/> Morgan	<input type="checkbox"/> Raleigh	<input checked="" type="checkbox"/> Upshur
<input type="checkbox"/> Berkeley	<input type="checkbox"/> Fayette	<input type="checkbox"/> Jackson	<input type="checkbox"/> Mason	<input type="checkbox"/> Nicholas	<input checked="" type="checkbox"/> Randolph	<input type="checkbox"/> Wayne
<input type="checkbox"/> Boone	<input type="checkbox"/> Gilmer	<input type="checkbox"/> Jefferson	<input type="checkbox"/> McDowell	<input type="checkbox"/> Ohio	<input type="checkbox"/> Ritchie	<input type="checkbox"/> Webster
<input type="checkbox"/> Braxton	<input type="checkbox"/> Grant	<input type="checkbox"/> Kanawha	<input type="checkbox"/> Mercer	<input checked="" type="checkbox"/> Pendleton	<input type="checkbox"/> Roane	<input type="checkbox"/> Wetzel
<input type="checkbox"/> Brooke	<input type="checkbox"/> Greenbrier	<input checked="" type="checkbox"/> Lewis	<input type="checkbox"/> Mineral	<input type="checkbox"/> Pleasants	<input type="checkbox"/> Summers	<input type="checkbox"/> Wirt
<input type="checkbox"/> Cabell	<input type="checkbox"/> Hampshire	<input type="checkbox"/> Lincoln	<input type="checkbox"/> Mingo	<input checked="" type="checkbox"/> Pocahontas	<input type="checkbox"/> Taylor	<input type="checkbox"/> Wood
<input type="checkbox"/> Calhoun	<input type="checkbox"/> Hancock	<input type="checkbox"/> Logan	<input type="checkbox"/> Monongalia	<input type="checkbox"/> Preston	<input checked="" type="checkbox"/> Tucker	<input type="checkbox"/> Wyoming
<input type="checkbox"/> Clay	<input type="checkbox"/> Hardy	<input type="checkbox"/> Marion	<input type="checkbox"/> Monroe	<input type="checkbox"/> Putnam	<input type="checkbox"/> Tyler	<input type="checkbox"/> STATEWIDE

Supplier Name - Vendor's Sourced Plant	Contract Item #	Contract Item Description	Unit of Measure	List Price
West Virginia Paving, Inc - Elkins, WV Plant		Asphalt Section 401 - Base I	TON	\$55.50
West Virginia Paving, Inc - Elkins, WV Plant	A2	Asphalt Section 401 - 25mm Superpave	TON	\$56.75
West Virginia Paving, Inc - Elkins, WV Plant	A3	Asphalt Section 401 - Base II	TON	\$60.00
West Virginia Paving, Inc - Elkins, WV Plant	A4	Asphalt Section 401 - Patch and Level	TON	\$60.00
West Virginia Paving, Inc - Elkins, WV Plant	A5	Asphalt Section 401 - Wearing IV	TON	\$60.00
West Virginia Paving, Inc - Elkins, WV Plant	A6	Asphalt Section 402 - Wearing IV	TON	\$60.00
West Virginia Paving, Inc - Elkins, WV Plant	A7	Asphalt Section 401 - 19mm Superpave	TON	\$60.00
West Virginia Paving, Inc - Elkins, WV Plant	A8	Asphalt Section 401 - Scratch Course	TON	\$65.00
West Virginia Paving, Inc - Elkins, WV Plant	A9	Asphalt Section 402 - 9.5mm Superpave	TON	\$68.00
West Virginia Paving, Inc - Elkins, WV Plant	A10	Asphalt Section 401 - Wearing 1	TON	\$65.00
West Virginia Paving, Inc - Elkins, WV Plant	A11	Asphalt Section 402 - Wearing 1	TON	\$68.00
West Virginia Paving, Inc - Elkins, WV Plant	A12	Asphalt Section 401 - 4.75mm Superpave	TON	No Bid
West Virginia Paving, Inc - Elkins, WV Plant	A13	Asphalt Section 402 - 4.75mm Superpave	TON	No Bid
West Virginia Paving, Inc - Elkins, WV Plant	A14	Asphalt Section 401 - Wearing III	TON	\$72.00
West Virginia Paving, Inc - Elkins, WV Plant	A15	Asphalt Section 402 - Wearing III	TON	No Bid
West Virginia Paving, Inc - Elkins, WV Plant	A16	Asphalt Section 401 - 12.5mm Superpave	TON	\$67.00
West Virginia Paving, Inc - Elkins, WV Plant	A17	Asphalt Section 402 - 12.5mm Superpave	TON	\$67.00
West Virginia Paving, Inc - Elkins, WV Plant	B	Shoulder Stone Placement for Asphalt Section 307 - Class 10	TON	\$40.00
	C	Shoulder Stone Mobilization - Complete on Attachment B (ATT B)	LUMP SUM	-----
West Virginia Paving, Inc - Elkins, WV Plant	D1	Haul by Vendor Shoulder Stone Placement - First Ton Mile	MILE	\$1.50
West Virginia Paving, Inc - Elkins, WV Plant	D2	Haul by Vendor Shoulder Stone Placement - Each Additional Mile	MILE	\$0.24
West Virginia Paving, Inc - Elkins, WV Plant	E1	Surcharge for PG Binder - 70 minus 22	TON	\$4.00
West Virginia Paving, Inc - Elkins, WV Plant	E2	Surcharge for PG Binder 76 minus 22 ordered in 400 Ton increments	TON	\$12.00
West Virginia Paving, Inc - Elkins, WV Plant	F1	Asphalt Haul by Vendor - First Ton Mile	MILE	\$1.50
West Virginia Paving, Inc - Elkins, WV Plant	F2	Asphalt Haul by Vendor - Each Additional Mile	MILE	\$0.21
West Virginia Paving, Inc - Elkins, WV Plant	G1	Laydown of Materials. Items A and V, Each Site 0 to 100 Tons	TON	\$65.00
West Virginia Paving, Inc - Elkins, WV Plant	G2	Laydown of Materials. Items A and V, Each Site 101 to 200 Tons	TON	\$26.00
West Virginia Paving, Inc - Elkins, WV Plant	G3	Laydown of Materials. Items A and V, Each Site 201 to 500 Tons	TON	\$11.00
West Virginia Paving, Inc - Elkins, WV Plant	G4	Laydown of Materials. Items A and V, Each Site 501 Tons or Greater	TON	\$8.50
	H1	Mobilization - Daytime Paving - Complete on Attachment B (ATT B)	LUMP SUM	-----
	H2	Mobilization - Nighttime Paving - Complete on Attachment B (ATT B)	LUMP SUM	-----
West Virginia Paving, Inc - Elkins, WV Plant	I1	Excavation for Shoulder Paving - 0 to 1000 Sq. Yards	SY	\$5.75
West Virginia Paving, Inc - Elkins, WV Plant	I2	Excavation for Shoulder Paving - 1001 to 2000 Sq. Yards	SY	\$3.75
West Virginia Paving, Inc - Elkins, WV Plant	I3	Excavation for Shoulder Paving - 2001 to 3000 Sq. Yards	SY	\$2.75
West Virginia Paving, Inc - Elkins, WV Plant	I4	Excavation for Shoulder Paving - 3001 Sq. Yards or Greater	SY	\$1.75
West Virginia Paving, Inc - Elkins, WV Plant	J1	Asphalt Base I Shoulder Paving Surcharge - 0 to 100 Tons	TON	\$20.00
West Virginia Paving, Inc - Elkins, WV Plant	J2	Asphalt Base I Shoulder Paving Surcharge - 101 to 200 Tons	TON	\$15.00
West Virginia Paving, Inc - Elkins, WV Plant	J3	Asphalt Base I Shoulder Paving Surcharge - 201 to 500 Tons	TON	\$4.00
West Virginia Paving, Inc - Elkins, WV Plant	J4	Asphalt Base I Shoulder Paving Surcharge - 501 Tons or Greater	TON	\$2.00
West Virginia Paving, Inc - Elkins, WV Plant	K1	Asphalt Base II Shoulder Paving Surcharge - 0 to 100 Tons	TON	\$20.00
West Virginia Paving, Inc - Elkins, WV Plant	K2	Asphalt Base II Shoulder Paving Surcharge - 101 to 200 Tons	TON	\$15.00
West Virginia Paving, Inc - Elkins, WV Plant	K3	Asphalt Base II Shoulder Paving Surcharge - 201 to 500 Tons	TON	\$4.00
West Virginia Paving, Inc - Elkins, WV Plant	K4	Asphalt Base II Shoulder Paving Surcharge - 501 Tons or Greater	TON	\$2.00
West Virginia Paving, Inc - Elkins, WV Plant	L	Asphalt Material for Tack Coat or Prime Material	GAL	\$2.50
West Virginia Paving, Inc - Elkins, WV Plant	M	Additional Heel-In Joints	LF	\$12.00
West Virginia Paving, Inc - Elkins, WV Plant	N	Skip Paving Surcharge	TON	\$4.50
West Virginia Paving, Inc - Elkins, WV Plant	O1	Pavement Profiling/Milling-WVDOH Owns Millings 0 to 250 Sq. Yards	SY	\$20.85
West Virginia Paving, Inc - Elkins, WV Plant	O2	Pavement Profiling/Milling-WVDOH Owns Millings 251 to 500 Sq. Yards	SY	\$15.85
West Virginia Paving, Inc - Elkins, WV Plant	O3	Pavement Profiling/Milling-WVDOH Owns Millings 501 to 1000 Sq. Yards	SY	\$10.85
West Virginia Paving, Inc - Elkins, WV Plant	O4	Pavement Profiling/Milling-WVDOH Owns Millings 1001 to 2500 Sq. Yards	SY	\$5.85
West Virginia Paving, Inc - Elkins, WV Plant	O5	Pavement Profiling/Milling-WVDOH Owns Millings 2501 to 5000 Sq. Yards	SY	\$3.85
West Virginia Paving, Inc - Elkins, WV Plant	O6	Pavement Profiling/Milling-WVDOH Owns Millings 5001 Sq. Yards or Greater	SY	\$2.55
West Virginia Paving, Inc - Elkins, WV Plant	P1	Pavement Profiling/Milling-Vendor Owns Millings 0 to 250 Sq. Yards	SY	\$20.45
West Virginia Paving, Inc - Elkins, WV Plant	P2	Pavement Profiling/Milling-Vendor Owns Millings 251 to 500 Sq. Yards	SY	\$15.45
West Virginia Paving, Inc - Elkins, WV Plant	P3	Pavement Profiling/Milling-Vendor Owns Millings 501 to 1000 Sq. Yards	SY	\$10.45
West Virginia Paving, Inc - Elkins, WV Plant	P4	Pavement Profiling/Milling-Vendor Owns Millings 1001 to 2500 Sq. Yards	SY	\$5.45
West Virginia Paving, Inc - Elkins, WV Plant	P5	Pavement Profiling/Milling-Vendor Owns Millings 2501 to 5000 Sq. Yards	SY	\$3.55
West Virginia Paving, Inc - Elkins, WV Plant	P6	Pavement Profiling/Milling-Vendor Owns Millings 5001 Sq. Yards or Greater	SY	\$2.45
	Q	Mobilization - Pavement Profiling/Milling - Complete on Attachment B (ATT B)	LUMP SUM	-----

Asphalt Materials Delivery & Labor by Vendor by County

ATTACHMENT A PRICING PAGE (ATT A)

Vendor name shall be entered here by the Vendor: West Virginia Paving, Inc. - Elkins, WV Plant

Vendor Instructions: For bidding, Vendor shall mark with an "X" the counties that correspond with the pricing on this page. If Vendor has varied pricing per county, Vendor shall complete a separate set of Pricing Pages (ATT A and ATT B) as well as separate Plant Information Forms (ATT C & ATT D) for each county pricing set. Vendor must complete TWO Pricing Pages (ATT A and ATT B) as well as all Plant Information Forms for each pricing set submitted.

<input checked="" type="checkbox"/> Barbour	<input type="checkbox"/> Doddridge	<input type="checkbox"/> Harrison	<input type="checkbox"/> Marshall	<input type="checkbox"/> Morgan	<input type="checkbox"/> Raleigh	<input checked="" type="checkbox"/> Upshur
<input type="checkbox"/> Berkeley	<input type="checkbox"/> Fayette	<input type="checkbox"/> Jackson	<input type="checkbox"/> Mason	<input type="checkbox"/> Nicholas	<input checked="" type="checkbox"/> Randolph	<input type="checkbox"/> Wayne
<input type="checkbox"/> Boone	<input type="checkbox"/> Gilmer	<input type="checkbox"/> Jefferson	<input type="checkbox"/> McDowell	<input type="checkbox"/> Ohio	<input type="checkbox"/> Ritchie	<input type="checkbox"/> Webster
<input type="checkbox"/> Braxton	<input type="checkbox"/> Grant	<input type="checkbox"/> Kanawha	<input type="checkbox"/> Mercer	<input checked="" type="checkbox"/> Pendleton	<input type="checkbox"/> Roane	<input type="checkbox"/> Wetzel
<input type="checkbox"/> Brooke	<input type="checkbox"/> Greenbrier	<input checked="" type="checkbox"/> Lewis	<input type="checkbox"/> Mineral	<input type="checkbox"/> Pleasants	<input type="checkbox"/> Summers	<input type="checkbox"/> Wirt
<input type="checkbox"/> Cabell	<input type="checkbox"/> Hampshire	<input type="checkbox"/> Lincoln	<input type="checkbox"/> Mingo	<input checked="" type="checkbox"/> Pocahontas	<input type="checkbox"/> Taylor	<input type="checkbox"/> Wood
<input type="checkbox"/> Calhoun	<input type="checkbox"/> Hancock	<input type="checkbox"/> Logan	<input type="checkbox"/> Monongalia	<input type="checkbox"/> Preston	<input checked="" type="checkbox"/> Tucker	<input type="checkbox"/> Wyoming
<input type="checkbox"/> Clay	<input type="checkbox"/> Hardy	<input type="checkbox"/> Marion	<input type="checkbox"/> Monroe	<input type="checkbox"/> Putnam	<input type="checkbox"/> Tyler	<input type="checkbox"/> STATEWIDE

Supplier Name - Vendor's Sourced Plant	Contract Item #	Contract Item Description	Unit of Measure	List Price
West Virginia Paving, Inc - Elkins, WV Plant	R1	Haul of Profiled/Milled Cuttings, First 10 Miles (Included with Contract Items O & P)	MILE	No Add'l Charge
West Virginia Paving, Inc - Elkins, WV Plant	R2	Haul of Profiled/Milled Cuttings, Each Additional Mile (Above 10 Miles)	LOADED MILE	\$4.80
West Virginia Paving, Inc - Elkins, WV Plant	S	Pavement Repair - Asphalt Base II	TON	\$325.00
West Virginia Paving, Inc - Elkins, WV Plant	T	Asphalt HPTO - SP496 - PG 64E-22 ordered 400 Ton increments	TON	No Bid
West Virginia Paving, Inc - Elkins, WV Plant	U	Non-Tracking Tack - to be used with T	GAL	No Bid
West Virginia Paving, Inc - Elkins, WV Plant	V	Lay Down of Materials - to be used with T - 400 Ton or Greater	TON	No Bid
West Virginia Paving, Inc - Elkins, WV Plant	W	Ultra-Thin Asphalt Overlay - SP498	TON	No Bid
West Virginia Paving, Inc - Elkins, WV Plant	X1	Fine Milling of Asphalt Pavement Surfaces - 0 to 250 Sq. Yards	SY	\$22.85
West Virginia Paving, Inc - Elkins, WV Plant	X2	Fine Milling of Asphalt Pavement Surfaces - 251 to 500 Sq. Yards	SY	\$17.85
West Virginia Paving, Inc - Elkins, WV Plant	X3	Fine Milling of Asphalt Pavement Surfaces - 501 to 1000 Sq. Yards	SY	\$12.85
West Virginia Paving, Inc - Elkins, WV Plant	X4	Fine Milling of Asphalt Pavement Surfaces 1001 to 2500 Sq. Yards	SY	\$6.70
West Virginia Paving, Inc - Elkins, WV Plant	X5	Fine Milling of Asphalt Pavement Surfaces 2501 to 5000 Sq. Yards	SY	\$4.85
West Virginia Paving, Inc - Elkins, WV Plant	X6	Fine Milling of Asphalt Pavement Surfaces - 5001 SY or Greater	SY	\$3.05
West Virginia Paving, Inc - Elkins, WV Plant	Y	Milled Rumble Strips	LF	\$0.50
	Z	Mobilization - Milled Rumble Strips - Complete on Attachment B (ATT B)	LUMP SUM	
West Virginia Paving, Inc - Elkins, WV Plant	AA	Surcharge for Parking Lot and Facility Paving - Items A	TON	\$7.00
West Virginia Paving, Inc - Elkins, WV Plant	AB	Cleaning and Sweeping	SY	\$0.01
West Virginia Paving, Inc - Elkins, WV Plant	AC1	Maintaining Traffic - Pilot Truck and Driver	DAY	\$900.00
West Virginia Paving, Inc - Elkins, WV Plant	AC2	Maintaining Traffic - Traffic Control Devices	UNIT	\$1.00
West Virginia Paving, Inc - Elkins, WV Plant	AC3	Maintaining Traffic - Flagger	HOUR	\$66.00
West Virginia Paving, Inc - Elkins, WV Plant	AC4	Maintaining Traffic - Arrow Board	DAY	\$30.00
West Virginia Paving, Inc - Elkins, WV Plant	AD1	Off-Season Plant Opening - First Day	DAY	\$3,500.00
West Virginia Paving, Inc - Elkins, WV Plant	AD2	Off-Season Plant Opening - Each Additional Day	DAY	\$1,000.00

Total Number of Attachment A pages submitted by Vendor is: 14

Asphalt Materials Delivery & Labor by Vendor by County

ATTACHMENT A PRICING PAGE (ATT A)

Vendor name shall be entered here by the Vendor: West Virginia Paving, Inc. - Asbury(Alta), WV Plant

Vendor Instructions: For bidding, Vendor shall mark with an "X" the counties that correspond with the pricing on this page. If Vendor has varied pricing per county, Vendor shall complete a separate set of Pricing Pages (ATT A and ATT B) as well as separate Plant Information Forms (ATT C & ATT D) for each county pricing set. Vendor must complete TWO Pricing Pages (ATT A and ATT B) as well as all Plant Information Forms for each pricing set submitted.

<input type="checkbox"/> Barbour	<input type="checkbox"/> Doddridge	<input type="checkbox"/> Harrison	<input type="checkbox"/> Marshall	<input type="checkbox"/> Morgan	<input type="checkbox"/> Raleigh	<input type="checkbox"/> Upshur
<input type="checkbox"/> Berkeley	<input checked="" type="checkbox"/> Fayette	<input type="checkbox"/> Jackson	<input type="checkbox"/> Mason	<input checked="" type="checkbox"/> Nicholas	<input type="checkbox"/> Randolph	<input type="checkbox"/> Wayne
<input type="checkbox"/> Boone	<input type="checkbox"/> Gilmer	<input type="checkbox"/> Jefferson	<input type="checkbox"/> McDowell	<input type="checkbox"/> Ohio	<input type="checkbox"/> Ritchie	<input type="checkbox"/> Webster
<input type="checkbox"/> Braxton	<input type="checkbox"/> Grant	<input type="checkbox"/> Kanawha	<input type="checkbox"/> Mercer	<input type="checkbox"/> Pendleton	<input type="checkbox"/> Roane	<input type="checkbox"/> Wetzel
<input type="checkbox"/> Brooke	<input checked="" type="checkbox"/> Greenbrier	<input type="checkbox"/> Lewis	<input type="checkbox"/> Mineral	<input type="checkbox"/> Pleasants	<input checked="" type="checkbox"/> Summers	<input type="checkbox"/> Wirt
<input type="checkbox"/> Cabell	<input type="checkbox"/> Hampshire	<input type="checkbox"/> Lincoln	<input type="checkbox"/> Mingo	<input type="checkbox"/> Pocahontas	<input type="checkbox"/> Taylor	<input type="checkbox"/> Wood
<input type="checkbox"/> Calhoun	<input type="checkbox"/> Hancock	<input type="checkbox"/> Logan	<input type="checkbox"/> Monongalia	<input type="checkbox"/> Preston	<input type="checkbox"/> Tucker	<input type="checkbox"/> Wyoming
<input type="checkbox"/> Clay	<input type="checkbox"/> Hardy	<input type="checkbox"/> Marion	<input checked="" type="checkbox"/> Monroe	<input type="checkbox"/> Putnam	<input type="checkbox"/> Tyler	<input type="checkbox"/> STATEWIDE

Supplier Name - Vendor's Sourced Plant	Contract Item #	Contract Item Description	Unit of Measure	List Price
West Virginia Paving, Inc - Asbury(Alta), WV Plant		Asphalt Section 401 - Base I	TON	\$64.00
West Virginia Paving, Inc - Asbury(Alta), WV Plant	A2	Asphalt Section 401 - 25mm Superpave	TON	\$67.50
West Virginia Paving, Inc - Asbury(Alta), WV Plant	A3	Asphalt Section 401 - Base II	TON	\$72.00
West Virginia Paving, Inc - Asbury(Alta), WV Plant	A4	Asphalt Section 401 - Patch and Level	TON	\$72.00
West Virginia Paving, Inc - Asbury(Alta), WV Plant	A5	Asphalt Section 401 - Wearing IV	TON	\$74.00
West Virginia Paving, Inc - Asbury(Alta), WV Plant	A6	Asphalt Section 402 - Wearing IV	TON	No Bid
West Virginia Paving, Inc - Asbury(Alta), WV Plant	A7	Asphalt Section 401 - 19mm Superpave	TON	\$71.00
West Virginia Paving, Inc - Asbury(Alta), WV Plant	A8	Asphalt Section 401 - Scratch Course	TON	\$75.00
West Virginia Paving, Inc - Asbury(Alta), WV Plant	A9	Asphalt Section 402 - 9.5mm Superpave	TON	\$84.50
West Virginia Paving, Inc - Asbury(Alta), WV Plant	A10	Asphalt Section 401 - Wearing 1	TON	\$75.00
West Virginia Paving, Inc - Asbury(Alta), WV Plant	A11	Asphalt Section 402 - Wearing 1	TON	\$83.50
West Virginia Paving, Inc - Asbury(Alta), WV Plant	A12	Asphalt Section 401 - 4.75mm Superpave	TON	No Bid
West Virginia Paving, Inc - Asbury(Alta), WV Plant	A13	Asphalt Section 402 - 4.75mm Superpave	TON	No Bid
West Virginia Paving, Inc - Asbury(Alta), WV Plant	A14	Asphalt Section 401 - Wearing III	TON	No Bid
West Virginia Paving, Inc - Asbury(Alta), WV Plant	A15	Asphalt Section 402 - Wearing III	TON	No Bid
West Virginia Paving, Inc - Asbury(Alta), WV Plant	A16	Asphalt Section 401 - 12.5mm Superpave	TON	\$74.50
West Virginia Paving, Inc - Asbury(Alta), WV Plant	A17	Asphalt Section 402 - 12.5mm Superpave	TON	\$74.50
West Virginia Paving, Inc - Asbury(Alta), WV Plant	B	Shoulder Stone Placement for Asphalt Section 307 - Class 10	TON	\$52.00
	C	Shoulder Stone Mobilization - Complete on Attachment B (ATT B)	LUMP SUM	-----
West Virginia Paving, Inc - Asbury(Alta), WV Plant	D1	Haul by Vendor Shoulder Stone Placement - First Ton Mile	MILE	\$1.50
West Virginia Paving, Inc - Asbury(Alta), WV Plant	D2	Haul by Vendor Shoulder Stone Placement - Each Additional Mile	MILE	\$0.24
West Virginia Paving, Inc - Asbury(Alta), WV Plant	E1	Surcharge for PG Binder - 70 minus 22	TON	\$4.00
West Virginia Paving, Inc - Asbury(Alta), WV Plant	E2	Surcharge for PG Binder 76 minus 22 ordered in 400 Ton increments	TON	\$12.00
West Virginia Paving, Inc - Asbury(Alta), WV Plant	F1	Asphalt Haul by Vendor - First Ton Mile	MILE	\$1.50
West Virginia Paving, Inc - Asbury(Alta), WV Plant	F2	Asphalt Haul by Vendor - Each Additional Mile	MILE	\$0.21
West Virginia Paving, Inc - Asbury(Alta), WV Plant	G1	Laydown of Materials. Items A and V, Each Site 0 to 100 Tons	TON	\$65.00
West Virginia Paving, Inc - Asbury(Alta), WV Plant	G2	Laydown of Materials. Items A and V, Each Site 101 to 200 Tons	TON	\$26.00
West Virginia Paving, Inc - Asbury(Alta), WV Plant	G3	Laydown of Materials. Items A and V, Each Site 201 to 500 Tons	TON	\$11.00
West Virginia Paving, Inc - Asbury(Alta), WV Plant	G4	Laydown of Materials. Items A and V, Each Site 501 Tons or Greater	TON	\$8.50
	H1	Mobilization - Daytime Paving - Complete on Attachment B (ATT B)	LUMP SUM	-----
	H2	Mobilization - Nighttime Paving - Complete on Attachment B (ATT B)	LUMP SUM	-----
West Virginia Paving, Inc - Asbury(Alta), WV Plant	I1	Excavation for Shoulder Paving - 0 to 1000 Sq. Yards	SY	\$5.75
West Virginia Paving, Inc - Asbury(Alta), WV Plant	I2	Excavation for Shoulder Paving - 1001 to 2000 Sq. Yards	SY	\$3.75
West Virginia Paving, Inc - Asbury(Alta), WV Plant	I3	Excavation for Shoulder Paving - 2001 to 3000 Sq. Yards	SY	\$2.75
West Virginia Paving, Inc - Asbury(Alta), WV Plant	I4	Excavation for Shoulder Paving - 3001 Sq. Yards or Greater	SY	\$1.75
West Virginia Paving, Inc - Asbury(Alta), WV Plant	J1	Asphalt Base I Shoulder Paving Surcharge - 0 to 100 Tons	TON	\$20.00
West Virginia Paving, Inc - Asbury(Alta), WV Plant	J2	Asphalt Base I Shoulder Paving Surcharge - 101 to 200 Tons	TON	\$15.00
West Virginia Paving, Inc - Asbury(Alta), WV Plant	J3	Asphalt Base I Shoulder Paving Surcharge - 201 to 500 Tons	TON	\$4.00
West Virginia Paving, Inc - Asbury(Alta), WV Plant	J4	Asphalt Base I Shoulder Paving Surcharge - 501 Tons or Greater	TON	\$2.00
West Virginia Paving, Inc - Asbury(Alta), WV Plant	K1	Asphalt Base II Shoulder Paving Surcharge - 0 to 100 Tons	TON	\$20.00
West Virginia Paving, Inc - Asbury(Alta), WV Plant	K2	Asphalt Base II Shoulder Paving Surcharge - 101 to 200 Tons	TON	\$15.00
West Virginia Paving, Inc - Asbury(Alta), WV Plant	K3	Asphalt Base II Shoulder Paving Surcharge - 201 to 500 Tons	TON	\$4.00
West Virginia Paving, Inc - Asbury(Alta), WV Plant	K4	Asphalt Base II Shoulder Paving Surcharge - 501 Tons or Greater	TON	\$2.00
West Virginia Paving, Inc - Asbury(Alta), WV Plant	L	Asphalt Material for Tack Coat or Prime Material	GAL	\$2.50
West Virginia Paving, Inc - Asbury(Alta), WV Plant	M	Additional Heel-In Joints	LF	\$12.00
West Virginia Paving, Inc - Asbury(Alta), WV Plant	N	Skip Paving Surcharge	TON	\$4.50
West Virginia Paving, Inc - Asbury(Alta), WV Plant	O1	Pavement Profiling/Milling-WVDOH Owns Millings 0 to 250 Sq. Yards	SY	\$20.85
West Virginia Paving, Inc - Asbury(Alta), WV Plant	O2	Pavement Profiling/Milling-WVDOH Owns Millings 251 to 500 Sq. Yards	SY	\$15.85
West Virginia Paving, Inc - Asbury(Alta), WV Plant	O3	Pavement Profiling/Milling-WVDOH Owns Millings 501 to 1000 Sq. Yards	SY	\$10.85
West Virginia Paving, Inc - Asbury(Alta), WV Plant	O4	Pavement Profiling/Milling-WVDOH Owns Millings 1001 to 2500 Sq. Yards	SY	\$5.85
West Virginia Paving, Inc - Asbury(Alta), WV Plant	O5	Pavement Profiling/Milling-WVDOH Owns Millings 2501 to 5000 Sq. Yards	SY	\$3.95
West Virginia Paving, Inc - Asbury(Alta), WV Plant	O6	Pavement Profiling/Milling-WVDOH Owns Millings 5001 Sq. Yards or Greater	SY	\$2.85
West Virginia Paving, Inc - Asbury(Alta), WV Plant	P1	Pavement Profiling/Milling-Vendor Owns Millings 0 to 250 Sq. Yards	SY	\$20.45
West Virginia Paving, Inc - Asbury(Alta), WV Plant	P2	Pavement Profiling/Milling-Vendor Owns Millings 251 to 500 Sq. Yards	SY	\$15.45
West Virginia Paving, Inc - Asbury(Alta), WV Plant	P3	Pavement Profiling/Milling-Vendor Owns Millings 501 to 1000 Sq. Yards	SY	\$10.45
West Virginia Paving, Inc - Asbury(Alta), WV Plant	P4	Pavement Profiling/Milling-Vendor Owns Millings 1001 to 2500 Sq. Yards	SY	\$5.45
West Virginia Paving, Inc - Asbury(Alta), WV Plant	P5	Pavement Profiling/Milling-Vendor Owns Millings 2501 to 5000 Sq. Yards	SY	\$3.55
West Virginia Paving, Inc - Asbury(Alta), WV Plant	P6	Pavement Profiling/Milling-Vendor Owns Millings 5001 Sq. Yards or Greater	SY	\$2.45
	Q	Mobilization - Pavement Profiling/Milling - Complete on Attachment B (ATT B)	LUMP SUM	-----

Asphalt Materials Delivery & Labor by Vendor by County

ATTACHMENT A PRICING PAGE (ATT A)

Vendor name shall be entered here by the Vendor: West Virginia Paving, Inc. - Asbury(Alta), WV Plant

Vendor Instructions: For bidding, Vendor shall mark with an "X" the counties that correspond with the pricing on this page. If Vendor has varied pricing per county, Vendor shall complete a separate set of Pricing Pages (ATT A and ATT B) as well as separate Plant Information Forms (ATT C & ATT D) for each county pricing set. Vendor must complete TWO Pricing Pages (ATT A and ATT B) as well as all Plant Information Forms for each pricing set submitted.

<input type="checkbox"/> Barbour	<input type="checkbox"/> Doddridge	<input type="checkbox"/> Harrison	<input type="checkbox"/> Marshall	<input type="checkbox"/> Morgan	<input type="checkbox"/> Raleigh	<input type="checkbox"/> Upshur
<input type="checkbox"/> Berkeley	<input checked="" type="checkbox"/> Fayette	<input type="checkbox"/> Jackson	<input type="checkbox"/> Mason	<input checked="" type="checkbox"/> Nicholas	<input type="checkbox"/> Randolph	<input type="checkbox"/> Wayne
<input type="checkbox"/> Boone	<input type="checkbox"/> Gilmer	<input type="checkbox"/> Jefferson	<input type="checkbox"/> McDowell	<input type="checkbox"/> Ohio	<input type="checkbox"/> Ritchie	<input type="checkbox"/> Webster
<input type="checkbox"/> Braxton	<input type="checkbox"/> Grant	<input type="checkbox"/> Kanawha	<input type="checkbox"/> Mercer	<input type="checkbox"/> Pendleton	<input type="checkbox"/> Roane	<input type="checkbox"/> Wetzel
<input type="checkbox"/> Brooke	<input checked="" type="checkbox"/> Greenbrier	<input type="checkbox"/> Lewis	<input type="checkbox"/> Mineral	<input type="checkbox"/> Pleasants	<input checked="" type="checkbox"/> Summers	<input type="checkbox"/> Wirt
<input type="checkbox"/> Cabell	<input type="checkbox"/> Hampshire	<input type="checkbox"/> Lincoln	<input type="checkbox"/> Mingo	<input type="checkbox"/> Pocahontas	<input type="checkbox"/> Taylor	<input type="checkbox"/> Wood
<input type="checkbox"/> Calhoun	<input type="checkbox"/> Hancock	<input type="checkbox"/> Logan	<input type="checkbox"/> Monongalia	<input type="checkbox"/> Preston	<input type="checkbox"/> Tucker	<input type="checkbox"/> Wyoming
<input type="checkbox"/> Clay	<input type="checkbox"/> Hardy	<input type="checkbox"/> Marion	<input checked="" type="checkbox"/> Monroe	<input type="checkbox"/> Putnam	<input type="checkbox"/> Tyler	<input type="checkbox"/> STATEWIDE

Supplier Name - Vendor's Sourced Plant	Contract Item #	Contract Item Description	Unit of Measure	List Price
West Virginia Paving, Inc - Asbury(Alta), WV Plant	R1	Haul of Profiled/Milled Cuttings, First 10 Miles (Included with Contract Items O & P)	MILE	No Add'l Charge
West Virginia Paving, Inc - Asbury(Alta), WV Plant	R2	Haul of Profiled/Milled Cuttings, Each Additional Mile (Above 10 Miles)	LOADED MILE	\$4.80
West Virginia Paving, Inc - Asbury(Alta), WV Plant	S	Pavement Repair - Asphalt Base II	TON	\$325.00
West Virginia Paving, Inc - Asbury(Alta), WV Plant	T	Asphalt HPTO - SP496 - PG 64E-22 ordered 400 Ton increments	TON	No Bid
West Virginia Paving, Inc - Asbury(Alta), WV Plant	U	Non-Tracking Tack - to be used with T	GAL	No Bid
West Virginia Paving, Inc - Asbury(Alta), WV Plant	V	Lay Down of Materials - to be used with T - 400 Ton or Greater	TON	No Bid
West Virginia Paving, Inc - Asbury(Alta), WV Plant	W	Ultra-Thin Asphalt Overlay - SP498	TON	No Bid
West Virginia Paving, Inc - Asbury(Alta), WV Plant	X1	Fine Milling of Asphalt Pavement Surfaces - 0 to 250 Sq. Yards	SY	\$22.85
West Virginia Paving, Inc - Asbury(Alta), WV Plant	X2	Fine Milling of Asphalt Pavement Surfaces - 251 to 500 Sq. Yards	SY	\$17.85
West Virginia Paving, Inc - Asbury(Alta), WV Plant	X3	Fine Milling of Asphalt Pavement Surfaces - 501 to 1000 Sq. Yards	SY	\$12.85
West Virginia Paving, Inc - Asbury(Alta), WV Plant	X4	Fine Milling of Asphalt Pavement Surfaces 1001 to 2500 Sq. Yards	SY	\$6.70
West Virginia Paving, Inc - Asbury(Alta), WV Plant	X5	Fine Milling of Asphalt Pavement Surfaces 2501 to 5000 Sq. Yards	SY	\$4.85
West Virginia Paving, Inc - Asbury(Alta), WV Plant	X6	Fine Milling of Asphalt Pavement Surfaces - 5001 SY or Greater	SY	\$3.05
West Virginia Paving, Inc - Asbury(Alta), WV Plant	Y	Milled Rumble Strips	LF	\$0.50
	Z	Mobilization - Milled Rumble Strips - Complete on Attachment B (ATT B)	LUMP SUM	
West Virginia Paving, Inc - Asbury(Alta), WV Plant	AA	Surcharge for Parking Lot and Facility Paving - Items A	TON	\$7.00
West Virginia Paving, Inc - Asbury(Alta), WV Plant	AB	Cleaning and Sweeping	SY	\$0.01
West Virginia Paving, Inc - Asbury(Alta), WV Plant	AC1	Maintaining Traffic - Pilot Truck and Driver	DAY	\$900.00
West Virginia Paving, Inc - Asbury(Alta), WV Plant	AC2	Maintaining Traffic - Traffic Control Devices	UNIT	\$1.00
West Virginia Paving, Inc - Asbury(Alta), WV Plant	AC3	Maintaining Traffic - Flagger	HOUR	\$66.00
West Virginia Paving, Inc - Asbury(Alta), WV Plant	AC4	Maintaining Traffic - Arrow Board	DAY	\$30.00
West Virginia Paving, Inc - Asbury(Alta), WV Plant	AD1	Off-Season Plant Opening - First Day	DAY	\$3,500.00
West Virginia Paving, Inc - Asbury(Alta), WV Plant	AD2	Off-Season Plant Opening - Each Additional Day	DAY	\$1,000.00

Total Number of Attachment A pages submitted by Vendor is: 14

Asphalt Materials Delivery & Labor by Vendor by County

ATTACHMENT A PRICING PAGE (ATT A)

Vendor name shall be entered here by the Vendor: West Virginia Paving, Inc. - Summersville, WV Plant

Vendor Instructions: For bidding, Vendor shall mark with an "X" the counties that correspond with the pricing on this page. If Vendor has varied pricing per county, Vendor shall complete a separate set of Pricing Pages (ATT A and ATT B) as well as separate Plant Information Forms (ATT C & ATT D) for each county pricing set. Vendor must complete TWO Pricing Pages (ATT A and ATT B) as well as all Plant Information Forms for each pricing set submitted.

<input type="checkbox"/> Barbour	<input type="checkbox"/> Doddridge	<input type="checkbox"/> Harrison	<input type="checkbox"/> Marshall	<input type="checkbox"/> Morgan	<input type="checkbox"/> Raleigh	<input type="checkbox"/> Upshur
<input type="checkbox"/> Berkeley	<input checked="" type="checkbox"/> Fayette	<input type="checkbox"/> Jackson	<input type="checkbox"/> Mason	<input checked="" type="checkbox"/> Nicholas	<input type="checkbox"/> Randolph	<input type="checkbox"/> Wayne
<input type="checkbox"/> Boone	<input checked="" type="checkbox"/> Gilmer	<input type="checkbox"/> Jefferson	<input type="checkbox"/> McDowell	<input type="checkbox"/> Ohio	<input type="checkbox"/> Ritchie	<input checked="" type="checkbox"/> Webster
<input checked="" type="checkbox"/> Braxton	<input type="checkbox"/> Grant	<input type="checkbox"/> Kanawha	<input type="checkbox"/> Mercer	<input type="checkbox"/> Pendleton	<input type="checkbox"/> Roane	<input type="checkbox"/> Wetzel
<input type="checkbox"/> Brooke	<input type="checkbox"/> Greenbrier	<input type="checkbox"/> Lewis	<input type="checkbox"/> Mineral	<input type="checkbox"/> Pleasants	<input type="checkbox"/> Summers	<input type="checkbox"/> Wirt
<input type="checkbox"/> Cabell	<input type="checkbox"/> Hampshire	<input type="checkbox"/> Lincoln	<input type="checkbox"/> Mingo	<input type="checkbox"/> Pocahontas	<input type="checkbox"/> Taylor	<input type="checkbox"/> Wood
<input type="checkbox"/> Calhoun	<input type="checkbox"/> Hancock	<input type="checkbox"/> Logan	<input type="checkbox"/> Monongalia	<input type="checkbox"/> Preston	<input type="checkbox"/> Tucker	<input type="checkbox"/> Wyoming
<input type="checkbox"/> Clay	<input type="checkbox"/> Hardy	<input type="checkbox"/> Marion	<input type="checkbox"/> Monroe	<input type="checkbox"/> Putnam	<input type="checkbox"/> Tyler	<input type="checkbox"/> STATEWIDE

Supplier Name - Vendor's Sourced Plant	Contract Item #	Contract Item Description	Unit of Measure	List Price
West Virginia Paving, Inc - Summersville, WV Plant		Asphalt Section 401 - Base I	TON	\$72.25
West Virginia Paving, Inc - Summersville, WV Plant	A2	Asphalt Section 401 - 25mm Superpave	TON	\$74.50
West Virginia Paving, Inc - Summersville, WV Plant	A3	Asphalt Section 401 - Base II	TON	\$81.00
West Virginia Paving, Inc - Summersville, WV Plant	A4	Asphalt Section 401 - Patch and Level	TON	\$81.00
West Virginia Paving, Inc - Summersville, WV Plant	A5	Asphalt Section 401 - Wearing IV	TON	\$82.00
West Virginia Paving, Inc - Summersville, WV Plant	A6	Asphalt Section 402 - Wearing IV	TON	No Bid
West Virginia Paving, Inc - Summersville, WV Plant	A7	Asphalt Section 401 - 19mm Superpave	TON	\$78.00
West Virginia Paving, Inc - Summersville, WV Plant	A8	Asphalt Section 401 - Scratch Course	TON	\$83.50
West Virginia Paving, Inc - Summersville, WV Plant	A9	Asphalt Section 402 - 9.5mm Superpave	TON	\$84.50
West Virginia Paving, Inc - Summersville, WV Plant	A10	Asphalt Section 401 - Wearing 1	TON	\$83.50
West Virginia Paving, Inc - Summersville, WV Plant	A11	Asphalt Section 402 - Wearing 1	TON	\$87.00
West Virginia Paving, Inc - Summersville, WV Plant	A12	Asphalt Section 401 - 4.75mm Superpave	TON	No Bid
West Virginia Paving, Inc - Summersville, WV Plant	A13	Asphalt Section 402 - 4.75mm Superpave	TON	No Bid
West Virginia Paving, Inc - Summersville, WV Plant	A14	Asphalt Section 401 - Wearing III	TON	\$91.50
West Virginia Paving, Inc - Summersville, WV Plant	A15	Asphalt Section 402 - Wearing III	TON	No Bid
West Virginia Paving, Inc - Summersville, WV Plant	A16	Asphalt Section 401 - 12.5mm Superpave	TON	\$82.50
West Virginia Paving, Inc - Summersville, WV Plant	A17	Asphalt Section 402 - 12.5mm Superpave	TON	\$82.50
West Virginia Paving, Inc - Summersville, WV Plant	B	Shoulder Stone Placement for Asphalt Section 307 - Class 10	TON	\$52.00
-----	C	Shoulder Stone Mobilization - Complete on Attachment B (ATT B)	LUMP SUM	-----
West Virginia Paving, Inc - Summersville, WV Plant	D1	Haul by Vendor Shoulder Stone Placement - First Ton Mile	MILE	\$1.50
West Virginia Paving, Inc - Summersville, WV Plant	D2	Haul by Vendor Shoulder Stone Placement - Each Additional Mile	MILE	\$0.24
West Virginia Paving, Inc - Summersville, WV Plant	E1	Surcharge for PG Binder - 70 minus 22	TON	\$4.00
West Virginia Paving, Inc - Summersville, WV Plant	E2	Surcharge for PG Binder 76 minus 22 ordered in 400 Ton increments	TON	\$12.00
West Virginia Paving, Inc - Summersville, WV Plant	F1	Asphalt Haul by Vendor - First Ton Mile	MILE	\$1.50
West Virginia Paving, Inc - Summersville, WV Plant	F2	Asphalt Haul by Vendor - Each Additional Mile	MILE	\$0.21
West Virginia Paving, Inc - Summersville, WV Plant	G1	Laydown of Materials. Items A and V, Each Site 0 to 100 Tons	TON	\$65.00
West Virginia Paving, Inc - Summersville, WV Plant	G2	Laydown of Materials. Items A and V, Each Site 101 to 200 Tons	TON	\$26.00
West Virginia Paving, Inc - Summersville, WV Plant	G3	Laydown of Materials. Items A and V, Each Site 201 to 500 Tons	TON	\$11.00
West Virginia Paving, Inc - Summersville, WV Plant	G4	Laydown of Materials. Items A and V, Each Site 501 Tons or Greater	TON	\$8.50
-----	H1	Mobilization - Daytime Paving - Complete on Attachment B (ATT B)	LUMP SUM	-----
-----	H2	Mobilization - Nighttime Paving - Complete on Attachment B (ATT B)	LUMP SUM	-----
West Virginia Paving, Inc - Summersville, WV Plant	I1	Excavation for Shoulder Paving - 0 to 1000 Sq. Yards	SY	\$5.75
West Virginia Paving, Inc - Summersville, WV Plant	I2	Excavation for Shoulder Paving - 1001 to 2000 Sq. Yards	SY	\$3.75
West Virginia Paving, Inc - Summersville, WV Plant	I3	Excavation for Shoulder Paving - 2001 to 3000 Sq. Yards	SY	\$2.75
West Virginia Paving, Inc - Summersville, WV Plant	I4	Excavation for Shoulder Paving - 3001 Sq. Yards or Greater	SY	\$1.75
West Virginia Paving, Inc - Summersville, WV Plant	J1	Asphalt Base I Shoulder Paving Surcharge - 0 to 100 Tons	TON	\$20.00
West Virginia Paving, Inc - Summersville, WV Plant	J2	Asphalt Base I Shoulder Paving Surcharge - 101 to 200 Tons	TON	\$15.00
West Virginia Paving, Inc - Summersville, WV Plant	J3	Asphalt Base I Shoulder Paving Surcharge - 201 to 500 Tons	TON	\$4.00
West Virginia Paving, Inc - Summersville, WV Plant	J4	Asphalt Base I Shoulder Paving Surcharge - 501 Tons or Greater	TON	\$2.00
West Virginia Paving, Inc - Summersville, WV Plant	K1	Asphalt Base II Shoulder Paving Surcharge - 0 to 100 Tons	TON	\$20.00
West Virginia Paving, Inc - Summersville, WV Plant	K2	Asphalt Base II Shoulder Paving Surcharge - 101 to 200 Tons	TON	\$15.00
West Virginia Paving, Inc - Summersville, WV Plant	K3	Asphalt Base II Shoulder Paving Surcharge - 201 to 500 Tons	TON	\$4.00
West Virginia Paving, Inc - Summersville, WV Plant	K4	Asphalt Base II Shoulder Paving Surcharge - 501 Tons or Greater	TON	\$2.00
West Virginia Paving, Inc - Summersville, WV Plant	L	Asphalt Material for Tack Coat or Prime Material	GAL	\$2.50
West Virginia Paving, Inc - Summersville, WV Plant	M	Additional Heel-In Joints	LF	\$12.00
West Virginia Paving, Inc - Summersville, WV Plant	N	Skip Paving Surcharge	TON	\$4.50
West Virginia Paving, Inc - Summersville, WV Plant	O1	Pavement Profiling/Milling-WVDOH Owns Millings 0 to 250 Sq. Yards	SY	\$20.85
West Virginia Paving, Inc - Summersville, WV Plant	O2	Pavement Profiling/Milling-WVDOH Owns Millings 251 to 500 Sq. Yards	SY	\$15.85
West Virginia Paving, Inc - Summersville, WV Plant	O3	Pavement Profiling/Milling-WVDOH Owns Millings 501 to 1000 Sq. Yards	SY	\$10.85
West Virginia Paving, Inc - Summersville, WV Plant	O4	Pavement Profiling/Milling-WVDOH Owns Millings 1001 to 2500 Sq. Yards	SY	\$5.85
West Virginia Paving, Inc - Summersville, WV Plant	O5	Pavement Profiling/Milling-WVDOH Owns Millings 2501 to 5000 Sq. Yards	SY	\$3.95
West Virginia Paving, Inc - Summersville, WV Plant	O6	Pavement Profiling/Milling-WVDOH Owns Millings 5001 Sq. Yards or Greater	SY	\$2.85
West Virginia Paving, Inc - Summersville, WV Plant	P1	Pavement Profiling/Milling-Vendor Owns Millings 0 to 250 Sq. Yards	SY	\$20.45
West Virginia Paving, Inc - Summersville, WV Plant	P2	Pavement Profiling/Milling-Vendor Owns Millings 251 to 500 Sq. Yards	SY	\$15.45
West Virginia Paving, Inc - Summersville, WV Plant	P3	Pavement Profiling/Milling-Vendor Owns Millings 501 to 1000 Sq. Yards	SY	\$10.45
West Virginia Paving, Inc - Summersville, WV Plant	P4	Pavement Profiling/Milling-Vendor Owns Millings 1001 to 2500 Sq. Yards	SY	\$5.45
West Virginia Paving, Inc - Summersville, WV Plant	P5	Pavement Profiling/Milling-Vendor Owns Millings 2501 to 5000 Sq. Yards	SY	\$3.55
West Virginia Paving, Inc - Summersville, WV Plant	P6	Pavement Profiling/Milling-Vendor Owns Millings 5001 Sq. Yards or Greater	SY	\$2.45
-----	Q	Mobilization - Pavement Profiling/Milling - Complete on Attachment B (ATT B)	LUMP SUM	-----

Asphalt Materials Delivery & Labor by Vendor by County

ATTACHMENT A PRICING PAGE (ATT A)

Vendor name shall be entered here by the Vendor: West Virginia Paving, Inc. - Summersville, WV Plant

Vendor Instructions: For bidding, Vendor shall mark with an "X" the counties that correspond with the pricing on this page. If Vendor has varied pricing per county, Vendor shall complete a separate set of Pricing Pages (ATT A and ATT B) as well as separate Plant Information Forms (ATT C & ATT D) for each county pricing set. Vendor must complete TWO Pricing Pages (ATT A and ATT B) as well as all Plant Information Forms for each pricing set submitted.

<input type="checkbox"/> Barbour	<input type="checkbox"/> Doddridge	<input type="checkbox"/> Harrison	<input type="checkbox"/> Marshall	<input type="checkbox"/> Morgan	<input type="checkbox"/> Raleigh	<input type="checkbox"/> Upshur
<input type="checkbox"/> Berkeley	<input checked="" type="checkbox"/> Fayette	<input type="checkbox"/> Jackson	<input type="checkbox"/> Mason	<input checked="" type="checkbox"/> Nicholas	<input type="checkbox"/> Randolph	<input type="checkbox"/> Wayne
<input type="checkbox"/> Boone	<input checked="" type="checkbox"/> Gilmer	<input type="checkbox"/> Jefferson	<input type="checkbox"/> McDowell	<input type="checkbox"/> Ohio	<input type="checkbox"/> Ritchie	<input checked="" type="checkbox"/> Webster
<input checked="" type="checkbox"/> Braxton	<input type="checkbox"/> Grant	<input type="checkbox"/> Kanawha	<input type="checkbox"/> Mercer	<input type="checkbox"/> Pendleton	<input type="checkbox"/> Roane	<input type="checkbox"/> Wetzel
<input type="checkbox"/> Brooke	<input type="checkbox"/> Greenbrier	<input type="checkbox"/> Lewis	<input type="checkbox"/> Mineral	<input type="checkbox"/> Pleasants	<input type="checkbox"/> Summers	<input type="checkbox"/> Wirt
<input type="checkbox"/> Cabell	<input type="checkbox"/> Hampshire	<input type="checkbox"/> Lincoln	<input type="checkbox"/> Mingo	<input type="checkbox"/> Pocahontas	<input type="checkbox"/> Taylor	<input type="checkbox"/> Wood
<input type="checkbox"/> Calhoun	<input type="checkbox"/> Hancock	<input type="checkbox"/> Logan	<input type="checkbox"/> Monongalia	<input type="checkbox"/> Preston	<input type="checkbox"/> Tucker	<input type="checkbox"/> Wyoming
<input type="checkbox"/> Clay	<input type="checkbox"/> Hardy	<input type="checkbox"/> Marion	<input type="checkbox"/> Monroe	<input type="checkbox"/> Putnam	<input type="checkbox"/> Tyler	<input type="checkbox"/> STATEWIDE

Supplier Name - Vendor's Sourced Plant	Contract Item #	Contract Item Description	Unit of Measure	List Price
West Virginia Paving, Inc - Summersville, WV Plant	R1	Haul of Profiled/Milled Cuttings, First 10 Miles (Included with Contract Items O & P)	MILE	No Add'l Charge
West Virginia Paving, Inc - Summersville, WV Plant	R2	Haul of Profiled/Milled Cuttings, Each Additional Mile (Above 10 Miles)	LOADED MILE	\$4.80
West Virginia Paving, Inc - Summersville, WV Plant	S	Pavement Repair - Asphalt Base II	TON	\$325.00
West Virginia Paving, Inc - Summersville, WV Plant	T	Asphalt HPTO - SP496 - PG 64E-22 ordered 400 Ton increments	TON	No Bid
West Virginia Paving, Inc - Summersville, WV Plant	U	Non-Tracking Tack - to be used with T	GAL	No Bid
West Virginia Paving, Inc - Summersville, WV Plant	V	Lay Down of Materials - to be used with T - 400 Ton or Greater	TON	No Bid
West Virginia Paving, Inc - Summersville, WV Plant	W	Ultra-Thin Asphalt Overlay - SP498	TON	No Bid
West Virginia Paving, Inc - Summersville, WV Plant	X1	Fine Milling of Asphalt Pavement Surfaces - 0 to 250 Sq. Yards	SY	\$22.85
West Virginia Paving, Inc - Summersville, WV Plant	X2	Fine Milling of Asphalt Pavement Surfaces - 251 to 500 Sq. Yards	SY	\$17.85
West Virginia Paving, Inc - Summersville, WV Plant	X3	Fine Milling of Asphalt Pavement Surfaces - 501 to 1000 Sq. Yards	SY	\$12.85
West Virginia Paving, Inc - Summersville, WV Plant	X4	Fine Milling of Asphalt Pavement Surfaces 1001 to 2500 Sq. Yards	SY	\$6.70
West Virginia Paving, Inc - Summersville, WV Plant	X5	Fine Milling of Asphalt Pavement Surfaces 2501 to 5000 Sq. Yards	SY	\$4.85
West Virginia Paving, Inc - Summersville, WV Plant	X6	Fine Milling of Asphalt Pavement Surfaces - 5001 SY or Greater	SY	\$3.05
West Virginia Paving, Inc - Summersville, WV Plant	Y	Milled Rumble Strips	LF	\$0.50
	Z	Mobilization - Milled Rumble Strips - Complete on Attachment B (ATT B)	LUMP SUM	
West Virginia Paving, Inc - Summersville, WV Plant	AA	Surcharge for Parking Lot and Facility Paving - Items A	TON	\$7.00
West Virginia Paving, Inc - Summersville, WV Plant	AB	Cleaning and Sweeping	SY	\$0.01
West Virginia Paving, Inc - Summersville, WV Plant	AC1	Maintaining Traffic - Pilot Truck and Driver	DAY	\$900.00
West Virginia Paving, Inc - Summersville, WV Plant	AC2	Maintaining Traffic - Traffic Control Devices	UNIT	\$1.00
West Virginia Paving, Inc - Summersville, WV Plant	AC3	Maintaining Traffic - Flagger	HOUR	\$66.00
West Virginia Paving, Inc - Summersville, WV Plant	AC4	Maintaining Traffic - Arrow Board	DAY	\$30.00
West Virginia Paving, Inc - Summersville, WV Plant	AD1	Off-Season Plant Opening - First Day	DAY	\$3,500.00
West Virginia Paving, Inc - Summersville, WV Plant	AD2	Off-Season Plant Opening - Each Additional Day	DAY	\$1,000.00

Total Number of Attachment A pages submitted by Vendor is: 14

Asphalt Materials Delivery & Labor by Vendor by County

ATTACHMENT A PRICING PAGE (ATT A)

Vendor name shall be entered here by the Vendor: West Virginia Paving, Inc. - Princeton, WV Plant

Vendor Instructions: For bidding, Vendor shall mark with an "X" the counties that correspond with the pricing on this page. If Vendor has varied pricing per county, Vendor shall complete a separate set of Pricing Pages (ATT A and ATT B) as well as separate Plant Information Forms (ATT C & ATT D) for each county pricing set. Vendor must complete TWO Pricing Pages (ATT A and ATT B) as well as all Plant Information Forms for each pricing set submitted.

<input type="checkbox"/> Barbour	<input type="checkbox"/> Doddridge	<input type="checkbox"/> Harrison	<input type="checkbox"/> Marshall	<input type="checkbox"/> Morgan	<input checked="" type="checkbox"/> Raleigh	<input type="checkbox"/> Upshur
<input type="checkbox"/> Berkeley	<input type="checkbox"/> Fayette	<input type="checkbox"/> Jackson	<input type="checkbox"/> Mason	<input type="checkbox"/> Nicholas	<input type="checkbox"/> Randolph	<input type="checkbox"/> Wayne
<input type="checkbox"/> Boone	<input type="checkbox"/> Gilmer	<input type="checkbox"/> Jefferson	<input checked="" type="checkbox"/> McDowell	<input type="checkbox"/> Ohio	<input type="checkbox"/> Ritchie	<input type="checkbox"/> Webster
<input type="checkbox"/> Braxton	<input type="checkbox"/> Grant	<input type="checkbox"/> Kanawha	<input checked="" type="checkbox"/> Mercer	<input type="checkbox"/> Pendleton	<input type="checkbox"/> Roane	<input type="checkbox"/> Wetzel
<input type="checkbox"/> Brooke	<input type="checkbox"/> Greenbrier	<input type="checkbox"/> Lewis	<input type="checkbox"/> Mineral	<input type="checkbox"/> Pleasants	<input checked="" type="checkbox"/> Summers	<input type="checkbox"/> Wirt
<input type="checkbox"/> Cabell	<input type="checkbox"/> Hampshire	<input type="checkbox"/> Lincoln	<input type="checkbox"/> Mingo	<input type="checkbox"/> Pocahontas	<input type="checkbox"/> Taylor	<input type="checkbox"/> Wood
<input type="checkbox"/> Calhoun	<input type="checkbox"/> Hancock	<input type="checkbox"/> Logan	<input type="checkbox"/> Monongalia	<input type="checkbox"/> Preston	<input type="checkbox"/> Tucker	<input checked="" type="checkbox"/> Wyoming
<input type="checkbox"/> Clay	<input type="checkbox"/> Hardy	<input type="checkbox"/> Marion	<input type="checkbox"/> Monroe	<input type="checkbox"/> Putnam	<input type="checkbox"/> Tyler	STATEWIDE

Supplier Name - Vendor's Sourced Plant	Contract Item #	Contract Item Description	Unit of Measure	List Price
West Virginia Paving, Inc - Princeton, WV Plant		Asphalt Section 401 - Base I	TON	\$53.75
West Virginia Paving, Inc - Princeton, WV Plant	A2	Asphalt Section 401 - 25mm Superpave	TON	\$59.50
West Virginia Paving, Inc - Princeton, WV Plant	A3	Asphalt Section 401 - Base II	TON	\$66.50
West Virginia Paving, Inc - Princeton, WV Plant	A4	Asphalt Section 401 - Patch and Level	TON	\$66.50
West Virginia Paving, Inc - Princeton, WV Plant	A5	Asphalt Section 401 - Wearing IV	TON	\$67.50
West Virginia Paving, Inc - Princeton, WV Plant	A6	Asphalt Section 402 - Wearing IV	TON	No Bid
West Virginia Paving, Inc - Princeton, WV Plant	A7	Asphalt Section 401 - 19mm Superpave	TON	\$66.50
West Virginia Paving, Inc - Princeton, WV Plant	A8	Asphalt Section 401 - Scratch Course	TON	\$68.75
West Virginia Paving, Inc - Princeton, WV Plant	A9	Asphalt Section 402 - 9.5mm Superpave	TON	\$76.00
West Virginia Paving, Inc - Princeton, WV Plant	A10	Asphalt Section 401 - Wearing 1	TON	\$68.75
West Virginia Paving, Inc - Princeton, WV Plant	A11	Asphalt Section 402 - Wearing 1	TON	\$76.00
West Virginia Paving, Inc - Princeton, WV Plant	A12	Asphalt Section 401 - 4.75mm Superpave	TON	No Bid
West Virginia Paving, Inc - Princeton, WV Plant	A13	Asphalt Section 402 - 4.75mm Superpave	TON	No Bid
West Virginia Paving, Inc - Princeton, WV Plant	A14	Asphalt Section 401 - Wearing III	TON	No Bid
West Virginia Paving, Inc - Princeton, WV Plant	A15	Asphalt Section 402 - Wearing III	TON	No Bid
West Virginia Paving, Inc - Princeton, WV Plant	A16	Asphalt Section 401 - 12.5mm Superpave	TON	\$75.00
West Virginia Paving, Inc - Princeton, WV Plant	A17	Asphalt Section 402 - 12.5mm Superpave	TON	\$75.00
West Virginia Paving, Inc - Princeton, WV Plant	B	Shoulder Stone Placement for Asphalt Section 307 - Class 10	TON	\$52.00
	C	Shoulder Stone Mobilization - Complete on Attachment B (ATT B)	LUMP SUM	-----
West Virginia Paving, Inc - Princeton, WV Plant	D1	Haul by Vendor Shoulder Stone Placement - First Ton Mile	MILE	\$1.50
West Virginia Paving, Inc - Princeton, WV Plant	D2	Haul by Vendor Shoulder Stone Placement - Each Additional Mile	MILE	\$0.24
West Virginia Paving, Inc - Princeton, WV Plant	E1	Surcharge for PG Binder - 70 minus 22	TON	\$4.00
West Virginia Paving, Inc - Princeton, WV Plant	E2	Surcharge for PG Binder 76 minus 22 ordered in 400 Ton increments	TON	\$12.00
West Virginia Paving, Inc - Princeton, WV Plant	F1	Asphalt Haul by Vendor - First Ton Mile	MILE	\$1.50
West Virginia Paving, Inc - Princeton, WV Plant	F2	Asphalt Haul by Vendor - Each Additional Mile	MILE	\$0.21
West Virginia Paving, Inc - Princeton, WV Plant	G1	Laydown of Materials. Items A and V, Each Site 0 to 100 Tons	TON	\$65.00
West Virginia Paving, Inc - Princeton, WV Plant	G2	Laydown of Materials. Items A and V, Each Site 101 to 200 Tons	TON	\$26.00
West Virginia Paving, Inc - Princeton, WV Plant	G3	Laydown of Materials. Items A and V, Each Site 201 to 500 Tons	TON	\$11.00
West Virginia Paving, Inc - Princeton, WV Plant	G4	Laydown of Materials. Items A and V, Each Site 501 Tons or Greater	TON	\$8.50
	H1	Mobilization - Daytime Paving - Complete on Attachment B (ATT B)	LUMP SUM	-----
	H2	Mobilization - Nighttime Paving - Complete on Attachment B (ATT B)	LUMP SUM	-----
West Virginia Paving, Inc - Princeton, WV Plant	I1	Excavation for Shoulder Paving - 0 to 1000 Sq. Yards	SY	\$5.75
West Virginia Paving, Inc - Princeton, WV Plant	I2	Excavation for Shoulder Paving - 1001 to 2000 Sq. Yards	SY	\$3.75
West Virginia Paving, Inc - Princeton, WV Plant	I3	Excavation for Shoulder Paving - 2001 to 3000 Sq. Yards	SY	\$2.75
West Virginia Paving, Inc - Princeton, WV Plant	I4	Excavation for Shoulder Paving - 3001 Sq. Yards or Greater	SY	\$1.75
West Virginia Paving, Inc - Princeton, WV Plant	J1	Asphalt Base I Shoulder Paving Surcharge - 0 to 100 Tons	TON	\$20.00
West Virginia Paving, Inc - Princeton, WV Plant	J2	Asphalt Base I Shoulder Paving Surcharge - 101 to 200 Tons	TON	\$15.00
West Virginia Paving, Inc - Princeton, WV Plant	J3	Asphalt Base I Shoulder Paving Surcharge - 201 to 500 Tons	TON	\$4.00
West Virginia Paving, Inc - Princeton, WV Plant	J4	Asphalt Base I Shoulder Paving Surcharge - 501 Tons or Greater	TON	\$2.00
West Virginia Paving, Inc - Princeton, WV Plant	K1	Asphalt Base II Shoulder Paving Surcharge - 0 to 100 Tons	TON	\$20.00
West Virginia Paving, Inc - Princeton, WV Plant	K2	Asphalt Base II Shoulder Paving Surcharge - 101 to 200 Tons	TON	\$15.00
West Virginia Paving, Inc - Princeton, WV Plant	K3	Asphalt Base II Shoulder Paving Surcharge - 201 to 500 Tons	TON	\$4.00
West Virginia Paving, Inc - Princeton, WV Plant	K4	Asphalt Base II Shoulder Paving Surcharge - 501 Tons or Greater	TON	\$2.00
West Virginia Paving, Inc - Princeton, WV Plant	L	Asphalt Material for Tack Coat or Prime Material	GAL	\$2.50
West Virginia Paving, Inc - Princeton, WV Plant	M	Additional Heel-In Joints	LF	\$12.00
West Virginia Paving, Inc - Princeton, WV Plant	N	Skip Paving Surcharge	TON	\$4.50
West Virginia Paving, Inc - Princeton, WV Plant	O1	Pavement Profiling/Milling-WVDOH Owns Millings 0 to 250 Sq. Yards	SY	\$20.85
West Virginia Paving, Inc - Princeton, WV Plant	O2	Pavement Profiling/Milling-WVDOH Owns Millings 251 to 500 Sq. Yards	SY	\$15.85
West Virginia Paving, Inc - Princeton, WV Plant	O3	Pavement Profiling/Milling-WVDOH Owns Millings 501 to 1000 Sq. Yards	SY	\$10.85
West Virginia Paving, Inc - Princeton, WV Plant	O4	Pavement Profiling/Milling-WVDOH Owns Millings 1001 to 2500 Sq. Yards	SY	\$5.85
West Virginia Paving, Inc - Princeton, WV Plant	O5	Pavement Profiling/Milling-WVDOH Owns Millings 2501 to 5000 Sq. Yards	SY	\$3.95
West Virginia Paving, Inc - Princeton, WV Plant	O6	Pavement Profiling/Milling-WVDOH Owns Millings 5001 Sq. Yards or Greater	SY	\$2.85
West Virginia Paving, Inc - Princeton, WV Plant	P1	Pavement Profiling/Milling-Vendor Owns Millings 0 to 250 Sq. Yards	SY	\$20.45
West Virginia Paving, Inc - Princeton, WV Plant	P2	Pavement Profiling/Milling-Vendor Owns Millings 251 to 500 Sq. Yards	SY	\$15.45
West Virginia Paving, Inc - Princeton, WV Plant	P3	Pavement Profiling/Milling-Vendor Owns Millings 501 to 1000 Sq. Yards	SY	\$10.45
West Virginia Paving, Inc - Princeton, WV Plant	P4	Pavement Profiling/Milling-Vendor Owns Millings 1001 to 2500 Sq. Yards	SY	\$5.45
West Virginia Paving, Inc - Princeton, WV Plant	P5	Pavement Profiling/Milling-Vendor Owns Millings 2501 to 5000 Sq. Yards	SY	\$3.55
West Virginia Paving, Inc - Princeton, WV Plant	P6	Pavement Profiling/Milling-Vendor Owns Millings 5001 Sq. Yards or Greater	SY	\$2.45
	Q	Mobilization - Pavement Profiling/Milling - Complete on Attachment B (ATT B)	LUMP SUM	-----

Asphalt Materials Delivery & Labor by Vendor by County

ATTACHMENT A PRICING PAGE (ATT A)

Vendor name shall be entered here by the Vendor: West Virginia Paving, Inc. - Princeton, WV Plant

Vendor Instructions: For bidding, Vendor shall mark with an "X" the counties that correspond with the pricing on this page. If Vendor has varied pricing per county, Vendor shall complete a separate set of Pricing Pages (ATT A and ATT B) as well as separate Plant Information Forms (ATT C & ATT D) for each county pricing set. Vendor must complete TWO Pricing Pages (ATT A and ATT B) as well as all Plant Information Forms for each pricing set submitted.

<input type="checkbox"/> Barbour	<input type="checkbox"/> Doddridge	<input type="checkbox"/> Harrison	<input type="checkbox"/> Marshall	<input type="checkbox"/> Morgan	<input checked="" type="checkbox"/> Raleigh	<input type="checkbox"/> Upshur
<input type="checkbox"/> Berkeley	<input type="checkbox"/> Fayette	<input type="checkbox"/> Jackson	<input type="checkbox"/> Mason	<input type="checkbox"/> Nicholas	<input type="checkbox"/> Randolph	<input type="checkbox"/> Wayne
<input type="checkbox"/> Boone	<input type="checkbox"/> Gilmer	<input type="checkbox"/> Jefferson	<input checked="" type="checkbox"/> McDowell	<input type="checkbox"/> Ohio	<input type="checkbox"/> Ritchie	<input type="checkbox"/> Webster
<input type="checkbox"/> Braxton	<input type="checkbox"/> Grant	<input type="checkbox"/> Kanawha	<input checked="" type="checkbox"/> Mercer	<input type="checkbox"/> Pendleton	<input type="checkbox"/> Roane	<input type="checkbox"/> Wetzel
<input type="checkbox"/> Brooke	<input type="checkbox"/> Greenbrier	<input type="checkbox"/> Lewis	<input type="checkbox"/> Mineral	<input type="checkbox"/> Pleasants	<input checked="" type="checkbox"/> Summers	<input type="checkbox"/> Wirt
<input type="checkbox"/> Cabell	<input type="checkbox"/> Hampshire	<input type="checkbox"/> Lincoln	<input type="checkbox"/> Mingo	<input type="checkbox"/> Pocahontas	<input type="checkbox"/> Taylor	<input type="checkbox"/> Wood
<input type="checkbox"/> Calhoun	<input type="checkbox"/> Hancock	<input type="checkbox"/> Logan	<input type="checkbox"/> Monongalia	<input type="checkbox"/> Preston	<input type="checkbox"/> Tucker	<input checked="" type="checkbox"/> Wyoming
<input type="checkbox"/> Clay	<input type="checkbox"/> Hardy	<input type="checkbox"/> Marion	<input type="checkbox"/> Monroe	<input type="checkbox"/> Putnam	<input type="checkbox"/> Tyler	STATEWIDE

Supplier Name - Vendor's Sourced Plant	Contract Item #	Contract Item Description	Unit of Measure	List Price
West Virginia Paving, Inc - Princeton, WV Plant	R1	Haul of Profiled/Milled Cuttings, First 10 Miles (Included with Contract Items O & P)	MILE	No Add'l Charge
West Virginia Paving, Inc - Princeton, WV Plant	R2	Haul of Profiled/Milled Cuttings, Each Additional Mile (Above 10 Miles)	LOADED MILE	\$4.80
West Virginia Paving, Inc - Princeton, WV Plant	S	Pavement Repair - Asphalt Base II	TON	\$325.00
West Virginia Paving, Inc - Princeton, WV Plant	T	Asphalt HPTO - SP496 - PG 64E-22 ordered 400 Ton increments	TON	No Bid
West Virginia Paving, Inc - Princeton, WV Plant	U	Non-Tracking Tack - to be used with T	GAL	No Bid
West Virginia Paving, Inc - Princeton, WV Plant	V	Lay Down of Materials - to be used with T - 400 Ton or Greater	TON	No Bid
West Virginia Paving, Inc - Princeton, WV Plant	W	Ultra-Thin Asphalt Overlay - SP498	TON	No Bid
West Virginia Paving, Inc - Princeton, WV Plant	X1	Fine Milling of Asphalt Pavement Surfaces - 0 to 250 Sq. Yards	SY	\$22.85
West Virginia Paving, Inc - Princeton, WV Plant	X2	Fine Milling of Asphalt Pavement Surfaces - 251 to 500 Sq. Yards	SY	\$17.85
West Virginia Paving, Inc - Princeton, WV Plant	X3	Fine Milling of Asphalt Pavement Surfaces - 501 to 1000 Sq. Yards	SY	\$12.85
West Virginia Paving, Inc - Princeton, WV Plant	X4	Fine Milling of Asphalt Pavement Surfaces 1001 to 2500 Sq. Yards	SY	\$6.70
West Virginia Paving, Inc - Princeton, WV Plant	X5	Fine Milling of Asphalt Pavement Surfaces 2501 to 5000 Sq. Yards	SY	\$4.85
West Virginia Paving, Inc - Princeton, WV Plant	X6	Fine Milling of Asphalt Pavement Surfaces - 5001 SY or Greater	SY	\$3.05
West Virginia Paving, Inc - Princeton, WV Plant	Y	Milled Rumble Strips	LF	\$0.50
	Z	Mobilization - Milled Rumble Strips - Complete on Attachment B (ATT B)	LUMP SUM	
West Virginia Paving, Inc - Princeton, WV Plant	AA	Surcharge for Parking Lot and Facility Paving - Items A	TON	\$7.00
West Virginia Paving, Inc - Princeton, WV Plant	AB	Cleaning and Sweeping	SY	\$0.01
West Virginia Paving, Inc - Princeton, WV Plant	AC1	Maintaining Traffic - Pilot Truck and Driver	DAY	\$900.00
West Virginia Paving, Inc - Princeton, WV Plant	AC2	Maintaining Traffic - Traffic Control Devices	UNIT	\$1.00
West Virginia Paving, Inc - Princeton, WV Plant	AC3	Maintaining Traffic - Flagger	HOUR	\$66.00
West Virginia Paving, Inc - Princeton, WV Plant	AC4	Maintaining Traffic - Arrow Board	DAY	\$30.00
West Virginia Paving, Inc - Princeton, WV Plant	AD1	Off-Season Plant Opening - First Day	DAY	\$3,500.00
West Virginia Paving, Inc - Princeton, WV Plant	AD2	Off-Season Plant Opening - Each Additional Day	DAY	\$1,000.00

Total Number of **Attachment A** pages submitted by Vendor is: 14

Asphalt Materials Delivery & Labor by Vendor by County

ATTACHMENT A PRICING PAGE (ATT A)

Vendor name shall be entered here by the Vendor: West Virginia Paving, Inc. - Ripley, WV Plant

Vendor Instructions: For bidding, Vendor shall mark with an "X" the counties that correspond with the pricing on this page. If Vendor has varied pricing per county, Vendor shall complete a separate set of Pricing Pages (ATT A and ATT B) as well as separate Plant Information Forms (ATT C & ATT D) for each county pricing set. Vendor must complete TWO Pricing Pages (ATT A and ATT B) as well as all Plant Information Forms for each pricing set submitted.

<input type="checkbox"/> Barbour	<input type="checkbox"/> Doddridge	<input type="checkbox"/> Harrison	<input type="checkbox"/> Marshall	<input type="checkbox"/> Morgan	<input type="checkbox"/> Raleigh	<input type="checkbox"/> Upshur
<input type="checkbox"/> Berkeley	<input type="checkbox"/> Fayette	<input checked="" type="checkbox"/> Jackson	<input checked="" type="checkbox"/> Mason	<input type="checkbox"/> Nicholas	<input type="checkbox"/> Randolph	<input type="checkbox"/> Wayne
<input type="checkbox"/> Boone	<input type="checkbox"/> Gilmer	<input type="checkbox"/> Jefferson	<input type="checkbox"/> McDowell	<input type="checkbox"/> Ohio	<input type="checkbox"/> Ritchie	<input type="checkbox"/> Webster
<input type="checkbox"/> Braxton	<input type="checkbox"/> Grant	<input type="checkbox"/> Kanawha	<input type="checkbox"/> Mercer	<input type="checkbox"/> Pendleton	<input checked="" type="checkbox"/> Roane	<input type="checkbox"/> Wetzel
<input type="checkbox"/> Brooke	<input type="checkbox"/> Greenbrier	<input type="checkbox"/> Lewis	<input type="checkbox"/> Mineral	<input type="checkbox"/> Pleasants	<input type="checkbox"/> Summers	<input type="checkbox"/> Wirt
<input type="checkbox"/> Cabell	<input type="checkbox"/> Hampshire	<input type="checkbox"/> Lincoln	<input type="checkbox"/> Mingo	<input type="checkbox"/> Pocahontas	<input type="checkbox"/> Taylor	<input checked="" type="checkbox"/> Wood
<input checked="" type="checkbox"/> Calhoun	<input type="checkbox"/> Hancock	<input type="checkbox"/> Logan	<input type="checkbox"/> Monongalia	<input type="checkbox"/> Preston	<input type="checkbox"/> Tucker	<input type="checkbox"/> Wyoming
<input type="checkbox"/> Clay	<input type="checkbox"/> Hardy	<input type="checkbox"/> Marion	<input type="checkbox"/> Monroe	<input checked="" type="checkbox"/> Putnam	<input type="checkbox"/> Tyler	STATEWIDE

Supplier Name - Vendor's Sourced Plant	Contract Item #	Contract Item Description	Unit of Measure	List Price
West Virginia Paving, Inc - Ripley, WV Plant		Asphalt Section 401 - Base I	TON	No Bid
West Virginia Paving, Inc - Ripley, WV Plant	A2	Asphalt Section 401 - 25mm Superpave	TON	No Bid
West Virginia Paving, Inc - Ripley, WV Plant	A3	Asphalt Section 401 - Base II	TON	\$73.00
West Virginia Paving, Inc - Ripley, WV Plant	A4	Asphalt Section 401 - Patch and Level	TON	\$73.00
West Virginia Paving, Inc - Ripley, WV Plant	A5	Asphalt Section 401 - Wearing IV	TON	\$75.00
West Virginia Paving, Inc - Ripley, WV Plant	A6	Asphalt Section 402 - Wearing IV	TON	No Bid
West Virginia Paving, Inc - Ripley, WV Plant	A7	Asphalt Section 401 - 19mm Superpave	TON	No Bid
West Virginia Paving, Inc - Ripley, WV Plant	A8	Asphalt Section 401 - Scratch Course	TON	\$76.00
West Virginia Paving, Inc - Ripley, WV Plant	A9	Asphalt Section 402 - 9.5mm Superpave	TON	No Bid
West Virginia Paving, Inc - Ripley, WV Plant	A10	Asphalt Section 401 - Wearing 1	TON	\$76.00
West Virginia Paving, Inc - Ripley, WV Plant	A11	Asphalt Section 402 - Wearing 1	TON	No Bid
West Virginia Paving, Inc - Ripley, WV Plant	A12	Asphalt Section 401 - 4.75mm Superpave	TON	No Bid
West Virginia Paving, Inc - Ripley, WV Plant	A13	Asphalt Section 402 - 4.75mm Superpave	TON	No Bid
West Virginia Paving, Inc - Ripley, WV Plant	A14	Asphalt Section 401 - Wearing III	TON	\$90.00
West Virginia Paving, Inc - Ripley, WV Plant	A15	Asphalt Section 402 - Wearing III	TON	No Bid
West Virginia Paving, Inc - Ripley, WV Plant	A16	Asphalt Section 401 - 12.5mm Superpave	TON	No Bid
West Virginia Paving, Inc - Ripley, WV Plant	A17	Asphalt Section 402 - 12.5mm Superpave	TON	No Bid
West Virginia Paving, Inc - Ripley, WV Plant	B	Shoulder Stone Placement for Asphalt Section 307 - Class 10	TON	\$57.00
	C	Shoulder Stone Mobilization - Complete on Attachment B (ATT B)	LUMP SUM	-----
West Virginia Paving, Inc - Ripley, WV Plant	D1	Haul by Vendor Shoulder Stone Placement - First Ton Mile	MILE	\$1.50
West Virginia Paving, Inc - Ripley, WV Plant	D2	Haul by Vendor Shoulder Stone Placement - Each Additional Mile	MILE	\$0.24
West Virginia Paving, Inc - Ripley, WV Plant	E1	Surcharge for PG Binder - 70 minus 22	TON	\$4.00
West Virginia Paving, Inc - Ripley, WV Plant	E2	Surcharge for PG Binder 76 minus 22 ordered in 400 Ton increments	TON	\$12.00
West Virginia Paving, Inc - Ripley, WV Plant	F1	Asphalt Haul by Vendor - First Ton Mile	MILE	\$1.50
West Virginia Paving, Inc - Ripley, WV Plant	F2	Asphalt Haul by Vendor - Each Additional Mile	MILE	\$0.21
West Virginia Paving, Inc - Ripley, WV Plant	G1	Laydown of Materials. Items A and V, Each Site 0 to 100 Tons	TON	\$65.00
West Virginia Paving, Inc - Ripley, WV Plant	G2	Laydown of Materials. Items A and V, Each Site 101 to 200 Tons	TON	\$26.00
West Virginia Paving, Inc - Ripley, WV Plant	G3	Laydown of Materials. Items A and V, Each Site 201 to 500 Tons	TON	\$11.00
West Virginia Paving, Inc - Ripley, WV Plant	G4	Laydown of Materials. Items A and V, Each Site 501 Tons or Greater	TON	\$8.50
	H1	Mobilization - Daytime Paving - Complete on Attachment B (ATT B)	LUMP SUM	-----
	H2	Mobilization - Nighttime Paving - Complete on Attachment B (ATT B)	LUMP SUM	-----
West Virginia Paving, Inc - Ripley, WV Plant	I1	Excavation for Shoulder Paving - 0 to 1000 Sq. Yards	SY	\$5.75
West Virginia Paving, Inc - Ripley, WV Plant	I2	Excavation for Shoulder Paving - 1001 to 2000 Sq. Yards	SY	\$3.75
West Virginia Paving, Inc - Ripley, WV Plant	I3	Excavation for Shoulder Paving - 2001 to 3000 Sq. Yards	SY	\$2.75
West Virginia Paving, Inc - Ripley, WV Plant	I4	Excavation for Shoulder Paving - 3001 Sq. Yards or Greater	SY	\$1.75
West Virginia Paving, Inc - Ripley, WV Plant	J1	Asphalt Base I Shoulder Paving Surcharge - 0 to 100 Tons	TON	\$20.00
West Virginia Paving, Inc - Ripley, WV Plant	J2	Asphalt Base I Shoulder Paving Surcharge - 101 to 200 Tons	TON	\$15.00
West Virginia Paving, Inc - Ripley, WV Plant	J3	Asphalt Base I Shoulder Paving Surcharge - 201 to 500 Tons	TON	\$4.00
West Virginia Paving, Inc - Ripley, WV Plant	J4	Asphalt Base I Shoulder Paving Surcharge - 501 Tons or Greater	TON	\$2.00
West Virginia Paving, Inc - Ripley, WV Plant	K1	Asphalt Base II Shoulder Paving Surcharge - 0 to 100 Tons	TON	\$20.00
West Virginia Paving, Inc - Ripley, WV Plant	K2	Asphalt Base II Shoulder Paving Surcharge - 101 to 200 Tons	TON	\$15.00
West Virginia Paving, Inc - Ripley, WV Plant	K3	Asphalt Base II Shoulder Paving Surcharge - 201 to 500 Tons	TON	\$4.00
West Virginia Paving, Inc - Ripley, WV Plant	K4	Asphalt Base II Shoulder Paving Surcharge - 501 Tons or Greater	TON	\$2.00
West Virginia Paving, Inc - Ripley, WV Plant	L	Asphalt Material for Tack Coat or Prime Material	GAL	\$2.50
West Virginia Paving, Inc - Ripley, WV Plant	M	Additional Heel-In Joints	LF	\$12.00
West Virginia Paving, Inc - Ripley, WV Plant	N	Skip Paving Surcharge	TON	\$4.50
West Virginia Paving, Inc - Ripley, WV Plant	O1	Pavement Profiling/Milling-WVDOH Owns Millings 0 to 250 Sq. Yards	SY	\$20.85
West Virginia Paving, Inc - Ripley, WV Plant	O2	Pavement Profiling/Milling-WVDOH Owns Millings 251 to 500 Sq. Yards	SY	\$15.85
West Virginia Paving, Inc - Ripley, WV Plant	O3	Pavement Profiling/Milling-WVDOH Owns Millings 501 to 1000 Sq. Yards	SY	\$10.85
West Virginia Paving, Inc - Ripley, WV Plant	O4	Pavement Profiling/Milling-WVDOH Owns Millings 1001 to 2500 Sq. Yards	SY	\$5.85
West Virginia Paving, Inc - Ripley, WV Plant	O5	Pavement Profiling/Milling-WVDOH Owns Millings 2501 to 5000 Sq. Yards	SY	\$3.95
West Virginia Paving, Inc - Ripley, WV Plant	O6	Pavement Profiling/Milling-WVDOH Owns Millings 5001 Sq. Yards or Greater	SY	\$2.85
West Virginia Paving, Inc - Ripley, WV Plant	P1	Pavement Profiling/Milling-Vendor Owns Millings 0 to 250 Sq. Yards	SY	\$20.45
West Virginia Paving, Inc - Ripley, WV Plant	P2	Pavement Profiling/Milling-Vendor Owns Millings 251 to 500 Sq. Yards	SY	\$15.45
West Virginia Paving, Inc - Ripley, WV Plant	P3	Pavement Profiling/Milling-Vendor Owns Millings 501 to 1000 Sq. Yards	SY	\$10.45
West Virginia Paving, Inc - Ripley, WV Plant	P4	Pavement Profiling/Milling-Vendor Owns Millings 1001 to 2500 Sq. Yards	SY	\$5.45
West Virginia Paving, Inc - Ripley, WV Plant	P5	Pavement Profiling/Milling-Vendor Owns Millings 2501 to 5000 Sq. Yards	SY	\$3.55
West Virginia Paving, Inc - Ripley, WV Plant	P6	Pavement Profiling/Milling-Vendor Owns Millings 5001 Sq. Yards or Greater	SY	\$2.45
	Q	Mobilization - Pavement Profiling/Milling - Complete on Attachment B (ATT B)	LUMP SUM	-----

Asphalt Materials Delivery & Labor by Vendor by County

ATTACHMENT A PRICING PAGE (ATT A)

Vendor name shall be entered here by the Vendor: West Virginia Paving, Inc. - Ripley, WV Plant

Vendor Instructions: For bidding, Vendor shall mark with an "X" the counties that correspond with the pricing on this page. If Vendor has varied pricing per county, Vendor shall complete a separate set of Pricing Pages (ATT A and ATT B) as well as separate Plant Information Forms (ATT C & ATT D) for each county pricing set. Vendor must complete TWO Pricing Pages (ATT A and ATT B) as well as all Plant Information Forms for each pricing set submitted.

<input type="checkbox"/> Barbour	<input type="checkbox"/> Doddridge	<input type="checkbox"/> Harrison	<input type="checkbox"/> Marshall	<input type="checkbox"/> Morgan	<input type="checkbox"/> Raleigh	<input type="checkbox"/> Upshur
<input type="checkbox"/> Berkeley	<input type="checkbox"/> Fayette	<input checked="" type="checkbox"/> Jackson	<input checked="" type="checkbox"/> Mason	<input type="checkbox"/> Nicholas	<input type="checkbox"/> Randolph	<input type="checkbox"/> Wayne
<input type="checkbox"/> Boone	<input type="checkbox"/> Gilmer	<input type="checkbox"/> Jefferson	<input type="checkbox"/> McDowell	<input type="checkbox"/> Ohio	<input type="checkbox"/> Ritchie	<input type="checkbox"/> Webster
<input type="checkbox"/> Braxton	<input type="checkbox"/> Grant	<input type="checkbox"/> Kanawha	<input type="checkbox"/> Mercer	<input type="checkbox"/> Pendleton	<input checked="" type="checkbox"/> Roane	<input type="checkbox"/> Wetzel
<input type="checkbox"/> Brooke	<input type="checkbox"/> Greenbrier	<input type="checkbox"/> Lewis	<input type="checkbox"/> Mineral	<input type="checkbox"/> Pleasants	<input type="checkbox"/> Summers	<input type="checkbox"/> Wirt
<input type="checkbox"/> Cabell	<input type="checkbox"/> Hampshire	<input type="checkbox"/> Lincoln	<input type="checkbox"/> Mingo	<input type="checkbox"/> Pocahontas	<input type="checkbox"/> Taylor	<input checked="" type="checkbox"/> Wood
<input checked="" type="checkbox"/> Calhoun	<input type="checkbox"/> Hancock	<input type="checkbox"/> Logan	<input type="checkbox"/> Monongalia	<input type="checkbox"/> Preston	<input type="checkbox"/> Tucker	<input type="checkbox"/> Wyoming
<input type="checkbox"/> Clay	<input type="checkbox"/> Hardy	<input type="checkbox"/> Marion	<input type="checkbox"/> Monroe	<input checked="" type="checkbox"/> Putnam	<input type="checkbox"/> Tyler	<input checked="" type="checkbox"/> STATEWIDE

Supplier Name - Vendor's Sourced Plant	Contract Item #	Contract Item Description	Unit of Measure	List Price
West Virginia Paving, Inc - Ripley, WV Plant	R1	Haul of Profiled/Milled Cuttings, First 10 Miles (Included with Contract Items O & P)	MILE	No Add'l Charge
West Virginia Paving, Inc - Ripley, WV Plant	R2	Haul of Profiled/Milled Cuttings, Each Additional Mile (Above 10 Miles)	LOADED MILE	\$4.80
West Virginia Paving, Inc - Ripley, WV Plant	S	Pavement Repair - Asphalt Base II	TON	\$325.00
West Virginia Paving, Inc - Ripley, WV Plant	T	Asphalt HPTO - SP496 - PG 64E-22 ordered 400 Ton increments	TON	No Bid
West Virginia Paving, Inc - Ripley, WV Plant	U	Non-Tracking Tack - to be used with T	GAL	No Bid
West Virginia Paving, Inc - Ripley, WV Plant	V	Lay Down of Materials - to be used with T - 400 Ton or Greater	TON	No Bid
West Virginia Paving, Inc - Ripley, WV Plant	W	Ultra-Thin Asphalt Overlay - SP498	TON	No Bid
West Virginia Paving, Inc - Ripley, WV Plant	X1	Fine Milling of Asphalt Pavement Surfaces - 0 to 250 Sq. Yards	SY	\$22.85
West Virginia Paving, Inc - Ripley, WV Plant	X2	Fine Milling of Asphalt Pavement Surfaces - 251 to 500 Sq. Yards	SY	\$17.85
West Virginia Paving, Inc - Ripley, WV Plant	X3	Fine Milling of Asphalt Pavement Surfaces - 501 to 1000 Sq. Yards	SY	\$12.85
West Virginia Paving, Inc - Ripley, WV Plant	X4	Fine Milling of Asphalt Pavement Surfaces 1001 to 2500 Sq. Yards	SY	\$6.70
West Virginia Paving, Inc - Ripley, WV Plant	X5	Fine Milling of Asphalt Pavement Surfaces 2501 to 5000 Sq. Yards	SY	\$4.85
West Virginia Paving, Inc - Ripley, WV Plant	X6	Fine Milling of Asphalt Pavement Surfaces - 5001 SY or Greater	SY	\$3.05
West Virginia Paving, Inc - Ripley, WV Plant	Y	Milled Rumble Strips	LF	\$0.50
	Z	Mobilization - Milled Rumble Strips - Complete on Attachment B (ATT B)	LUMP SUM	
West Virginia Paving, Inc - Ripley, WV Plant	AA	Surcharge for Parking Lot and Facility Paving - Items A	TON	\$7.00
West Virginia Paving, Inc - Ripley, WV Plant	AB	Cleaning and Sweeping	SY	\$0.01
West Virginia Paving, Inc - Ripley, WV Plant	AC1	Maintaining Traffic - Pilot Truck and Driver	DAY	\$900.00
West Virginia Paving, Inc - Ripley, WV Plant	AC2	Maintaining Traffic - Traffic Control Devices	UNIT	\$1.00
West Virginia Paving, Inc - Ripley, WV Plant	AC3	Maintaining Traffic - Flagger	HOUR	\$66.00
West Virginia Paving, Inc - Ripley, WV Plant	AC4	Maintaining Traffic - Arrow Board	DAY	\$30.00
West Virginia Paving, Inc - Ripley, WV Plant	AD1	Off-Season Plant Opening - First Day	DAY	\$3,500.00
West Virginia Paving, Inc - Ripley, WV Plant	AD2	Off-Season Plant Opening - Each Additional Day	DAY	\$1,000.00

Total Number of Attachment A pages submitted by Vendor is: 14

Asphalt Materials Delivery & Labor by Vendor by County

ATTACHMENT A PRICING PAGE (ATT A)

Vendor name shall be entered here by the Vendor: West Virginia Paving, Inc. - Bluefield, VA

Vendor Instructions: For bidding, Vendor shall mark with an "X" the counties that correspond with the pricing on this page. If Vendor has varied pricing per county, Vendor shall complete a separate set of Pricing Pages (ATT A and ATT B) as well as separate Plant Information Forms (ATT C & ATT D) for each county pricing set. Vendor must complete TWO Pricing Pages (ATT A and ATT B) as well as all Plant Information Forms for each pricing set submitted.

<input type="checkbox"/> Barbour	<input type="checkbox"/> Doddridge	<input type="checkbox"/> Harrison	<input type="checkbox"/> Marshall	<input type="checkbox"/> Morgan	<input type="checkbox"/> Raleigh	<input type="checkbox"/> Upshur
<input type="checkbox"/> Berkeley	<input type="checkbox"/> Fayette	<input type="checkbox"/> Jackson	<input type="checkbox"/> Mason	<input type="checkbox"/> Nicholas	<input type="checkbox"/> Randolph	<input type="checkbox"/> Wayne
<input type="checkbox"/> Boone	<input type="checkbox"/> Gilmer	<input type="checkbox"/> Jefferson	<input checked="" type="checkbox"/> McDowell	<input type="checkbox"/> Ohio	<input type="checkbox"/> Ritchie	<input type="checkbox"/> Webster
<input type="checkbox"/> Braxton	<input type="checkbox"/> Grant	<input type="checkbox"/> Kanawha	<input checked="" type="checkbox"/> Mercer	<input type="checkbox"/> Pendleton	<input type="checkbox"/> Roane	<input type="checkbox"/> Wetzel
<input type="checkbox"/> Brooke	<input type="checkbox"/> Greenbrier	<input type="checkbox"/> Lewis	<input type="checkbox"/> Mineral	<input type="checkbox"/> Pleasants	<input type="checkbox"/> Summers	<input type="checkbox"/> Wirt
<input type="checkbox"/> Cabell	<input type="checkbox"/> Hampshire	<input type="checkbox"/> Lincoln	<input type="checkbox"/> Mingo	<input type="checkbox"/> Pocahontas	<input type="checkbox"/> Taylor	<input type="checkbox"/> Wood
<input type="checkbox"/> Calhoun	<input type="checkbox"/> Hancock	<input type="checkbox"/> Logan	<input type="checkbox"/> Monongalia	<input type="checkbox"/> Preston	<input type="checkbox"/> Tucker	<input checked="" type="checkbox"/> Wyoming
<input type="checkbox"/> Clay	<input type="checkbox"/> Hardy	<input type="checkbox"/> Marion	<input type="checkbox"/> Monroe	<input type="checkbox"/> Putnam	<input type="checkbox"/> Tyler	STATEWIDE

Supplier Name - Vendor's Sourced Plant	Contract Item #	Contract Item Description	Unit of Measure	List Price
West Virginia Paving, Inc - Bluefield VA Plant		Asphalt Section 401 - Base I	TON	No Bid
West Virginia Paving, Inc - Bluefield VA Plant	A2	Asphalt Section 401 - 25mm Superpave	TON	No Bid
West Virginia Paving, Inc - Bluefield VA Plant	A3	Asphalt Section 401 - Base II	TON	\$66.50
West Virginia Paving, Inc - Bluefield VA Plant	A4	Asphalt Section 401 - Patch and Level	TON	\$66.50
West Virginia Paving, Inc - Bluefield VA Plant	A5	Asphalt Section 401 - Wearing IV	TON	\$67.50
West Virginia Paving, Inc - Bluefield VA Plant	A6	Asphalt Section 402 - Wearing IV	TON	No Bid
West Virginia Paving, Inc - Bluefield VA Plant	A7	Asphalt Section 401 - 19mm Superpave	TON	No Bid
West Virginia Paving, Inc - Bluefield VA Plant	A8	Asphalt Section 401 - Scratch Course	TON	\$72.00
West Virginia Paving, Inc - Bluefield VA Plant	A9	Asphalt Section 402 - 9.5mm Superpave	TON	No Bid
West Virginia Paving, Inc - Bluefield VA Plant	A10	Asphalt Section 401 - Wearing 1	TON	\$72.00
West Virginia Paving, Inc - Bluefield VA Plant	A11	Asphalt Section 402 - Wearing 1	TON	No Bid
West Virginia Paving, Inc - Bluefield VA Plant	A12	Asphalt Section 401 - 4.75mm Superpave	TON	No Bid
West Virginia Paving, Inc - Bluefield VA Plant	A13	Asphalt Section 402 - 4.75mm Superpave	TON	No Bid
West Virginia Paving, Inc - Bluefield VA Plant	A14	Asphalt Section 401 - Wearing III	TON	No Bid
West Virginia Paving, Inc - Bluefield VA Plant	A15	Asphalt Section 402 - Wearing III	TON	No Bid
West Virginia Paving, Inc - Bluefield VA Plant	A16	Asphalt Section 401 - 12.5mm Superpave	TON	No Bid
West Virginia Paving, Inc - Bluefield VA Plant	A17	Asphalt Section 402 - 12.5mm Superpave	TON	No Bid
West Virginia Paving, Inc - Bluefield VA Plant	B	Shoulder Stone Placement for Asphalt Section 307 - Class 10	TON	\$52.00
West Virginia Paving, Inc - Bluefield VA Plant	C	Shoulder Stone Mobilization - Complete on Attachment B (ATT B)	LUMP SUM	-----
West Virginia Paving, Inc - Bluefield VA Plant	D1	Haul by Vendor Shoulder Stone Placement - First Ton Mile	MILE	\$1.50
West Virginia Paving, Inc - Bluefield VA Plant	D2	Haul by Vendor Shoulder Stone Placement - Each Additional Mile	MILE	\$0.27
West Virginia Paving, Inc - Bluefield VA Plant	E1	Surcharge for PG Binder - 70 minus 22	TON	\$4.00
West Virginia Paving, Inc - Bluefield VA Plant	E2	Surcharge for PG Binder 76 minus 22 ordered in 400 Ton increments	TON	\$12.00
West Virginia Paving, Inc - Bluefield VA Plant	F1	Asphalt Haul by Vendor - First Ton Mile	MILE	\$1.50
West Virginia Paving, Inc - Bluefield VA Plant	F2	Asphalt Haul by Vendor - Each Additional Mile	MILE	\$0.27
West Virginia Paving, Inc - Bluefield VA Plant	G1	Laydown of Materials. Items A and V, Each Site 0 to 100 Tons	TON	\$65.00
West Virginia Paving, Inc - Bluefield VA Plant	G2	Laydown of Materials. Items A and V, Each Site 101 to 200 Tons	TON	\$26.00
West Virginia Paving, Inc - Bluefield VA Plant	G3	Laydown of Materials. Items A and V, Each Site 201 to 500 Tons	TON	\$11.00
West Virginia Paving, Inc - Bluefield VA Plant	G4	Laydown of Materials. Items A and V, Each Site 501 Tons or Greater	TON	\$8.50
West Virginia Paving, Inc - Bluefield VA Plant	H1	Mobilization - Daytime Paving - Complete on Attachment B (ATT B)	LUMP SUM	-----
West Virginia Paving, Inc - Bluefield VA Plant	H2	Mobilization - Nighttime Paving - Complete on Attachment B (ATT B)	LUMP SUM	-----
West Virginia Paving, Inc - Bluefield VA Plant	I1	Excavation for Shoulder Paving - 0 to 1000 Sq. Yards	SY	\$5.75
West Virginia Paving, Inc - Bluefield VA Plant	I2	Excavation for Shoulder Paving - 1001 to 2000 Sq. Yards	SY	\$3.75
West Virginia Paving, Inc - Bluefield VA Plant	I3	Excavation for Shoulder Paving - 2001 to 3000 Sq. Yards	SY	\$2.75
West Virginia Paving, Inc - Bluefield VA Plant	I4	Excavation for Shoulder Paving - 3001 Sq. Yards or Greater	SY	\$1.75
West Virginia Paving, Inc - Bluefield VA Plant	J1	Asphalt Base I Shoulder Paving Surcharge - 0 to 100 Tons	TON	\$20.00
West Virginia Paving, Inc - Bluefield VA Plant	J2	Asphalt Base I Shoulder Paving Surcharge - 101 to 200 Tons	TON	\$15.00
West Virginia Paving, Inc - Bluefield VA Plant	J3	Asphalt Base I Shoulder Paving Surcharge - 201 to 500 Tons	TON	\$4.00
West Virginia Paving, Inc - Bluefield VA Plant	J4	Asphalt Base I Shoulder Paving Surcharge - 501 Tons or Greater	TON	\$2.00
West Virginia Paving, Inc - Bluefield VA Plant	K1	Asphalt Base II Shoulder Paving Surcharge - 0 to 100 Tons	TON	\$20.00
West Virginia Paving, Inc - Bluefield VA Plant	K2	Asphalt Base II Shoulder Paving Surcharge - 101 to 200 Tons	TON	\$15.00
West Virginia Paving, Inc - Bluefield VA Plant	K3	Asphalt Base II Shoulder Paving Surcharge - 201 to 500 Tons	TON	\$4.00
West Virginia Paving, Inc - Bluefield VA Plant	K4	Asphalt Base II Shoulder Paving Surcharge - 501 Tons or Greater	TON	\$2.00
West Virginia Paving, Inc - Bluefield VA Plant	L	Asphalt Material for Tack Coat or Prime Material	GAL	\$2.50
West Virginia Paving, Inc - Bluefield VA Plant	M	Additional Heel-In Joints	LF	\$12.00
West Virginia Paving, Inc - Bluefield VA Plant	N	Skip Paving Surcharge	TON	\$4.50
West Virginia Paving, Inc - Bluefield VA Plant	O1	Pavement Profiling/Milling-WVDOH Owns Millings 0 to 250 Sq. Yards	SY	\$20.85
West Virginia Paving, Inc - Bluefield VA Plant	O2	Pavement Profiling/Milling-WVDOH Owns Millings 251 to 500 Sq. Yards	SY	\$15.85
West Virginia Paving, Inc - Bluefield VA Plant	O3	Pavement Profiling/Milling-WVDOH Owns Millings 501 to 1000 Sq. Yards	SY	\$10.85
West Virginia Paving, Inc - Bluefield VA Plant	O4	Pavement Profiling/Milling-WVDOH Owns Millings 1001 to 2500 Sq. Yards	SY	\$5.85
West Virginia Paving, Inc - Bluefield VA Plant	O5	Pavement Profiling/Milling-WVDOH Owns Millings 2501 to 5000 Sq. Yards	SY	\$3.95
West Virginia Paving, Inc - Bluefield VA Plant	O6	Pavement Profiling/Milling-WVDOH Owns Millings 5001 Sq. Yards or Greater	SY	\$2.85
West Virginia Paving, Inc - Bluefield VA Plant	P1	Pavement Profiling/Milling-Vendor Owns Millings 0 to 250 Sq. Yards	SY	\$20.45
West Virginia Paving, Inc - Bluefield VA Plant	P2	Pavement Profiling/Milling-Vendor Owns Millings 251 to 500 Sq. Yards	SY	\$15.45
West Virginia Paving, Inc - Bluefield VA Plant	P3	Pavement Profiling/Milling-Vendor Owns Millings 501 to 1000 Sq. Yards	SY	\$10.45
West Virginia Paving, Inc - Bluefield VA Plant	P4	Pavement Profiling/Milling-Vendor Owns Millings 1001 to 2500 Sq. Yards	SY	\$5.45
West Virginia Paving, Inc - Bluefield VA Plant	P5	Pavement Profiling/Milling-Vendor Owns Millings 2501 to 5000 Sq. Yards	SY	\$3.55
West Virginia Paving, Inc - Bluefield VA Plant	P6	Pavement Profiling/Milling-Vendor Owns Millings 5001 Sq. Yards or Greater	SY	\$2.45
West Virginia Paving, Inc - Bluefield VA Plant	Q	Mobilization - Pavement Profiling/Milling - Complete on Attachment B (ATT B)	LUMP SUM	-----

Asphalt Materials Delivery & Labor by Vendor by County

ATTACHMENT A PRICING PAGE (ATT A)

Vendor name shall be entered here by the Vendor: West Virginia Paving, Inc. - Bluefield, VA

Vendor Instructions: For bidding, Vendor shall mark with an "X" the counties that correspond with the pricing on this page. If Vendor has varied pricing per county, Vendor shall complete a separate set of Pricing Pages (ATT A and ATT B) as well as separate Plant Information Forms (ATT C & ATT D) for each county pricing set. Vendor must complete TWO Pricing Pages (ATT A and ATT B) as well as all Plant Information Forms for each pricing set submitted.

<input type="checkbox"/> Barbour	<input type="checkbox"/> Doddridge	<input type="checkbox"/> Harrison	<input type="checkbox"/> Marshall	<input type="checkbox"/> Morgan	<input type="checkbox"/> Raleigh	<input type="checkbox"/> Upshur
<input type="checkbox"/> Berkeley	<input type="checkbox"/> Fayette	<input type="checkbox"/> Jackson	<input type="checkbox"/> Mason	<input type="checkbox"/> Nicholas	<input type="checkbox"/> Randolph	<input type="checkbox"/> Wayne
<input type="checkbox"/> Boone	<input type="checkbox"/> Gilmer	<input type="checkbox"/> Jefferson	<input checked="" type="checkbox"/> McDowell	<input type="checkbox"/> Ohio	<input type="checkbox"/> Ritchie	<input type="checkbox"/> Webster
<input type="checkbox"/> Braxton	<input type="checkbox"/> Grant	<input type="checkbox"/> Kanawha	<input checked="" type="checkbox"/> Mercer	<input type="checkbox"/> Pendleton	<input type="checkbox"/> Roane	<input type="checkbox"/> Wetzel
<input type="checkbox"/> Brooke	<input type="checkbox"/> Greenbrier	<input type="checkbox"/> Lewis	<input type="checkbox"/> Mineral	<input type="checkbox"/> Pleasants	<input type="checkbox"/> Summers	<input type="checkbox"/> Wirt
<input type="checkbox"/> Cabell	<input type="checkbox"/> Hampshire	<input type="checkbox"/> Lincoln	<input type="checkbox"/> Mingo	<input type="checkbox"/> Pocahontas	<input type="checkbox"/> Taylor	<input type="checkbox"/> Wood
<input type="checkbox"/> Calhoun	<input type="checkbox"/> Hancock	<input type="checkbox"/> Logan	<input type="checkbox"/> Monongalia	<input type="checkbox"/> Preston	<input type="checkbox"/> Tucker	<input checked="" type="checkbox"/> Wyoming
<input type="checkbox"/> Clay	<input type="checkbox"/> Hardy	<input type="checkbox"/> Marion	<input type="checkbox"/> Monroe	<input type="checkbox"/> Putnam	<input type="checkbox"/> Tyler	STATEWIDE

Supplier Name - Vendor's Sourced Plant	Contract Item #	Contract Item Description	Unit of Measure	List Price
West Virginia Paving, Inc - Bluefield VA Plant	R1	Haul of Profiled/Milled Cuttings, First 10 Miles (Included with Contract Items O & P)	MILE	No Add'l Charge
West Virginia Paving, Inc - Bluefield VA Plant	R2	Haul of Profiled/Milled Cuttings, Each Additional Mile (Above 10 Miles)	LOADED MILE	\$4.80
West Virginia Paving, Inc - Bluefield VA Plant	S	Pavement Repair - Asphalt Base II	TON	\$325.00
West Virginia Paving, Inc - Bluefield VA Plant	T	Asphalt HPTO - SP496 - PG 64E-22 ordered 400 Ton increments	TON	No Bid
West Virginia Paving, Inc - Bluefield VA Plant	U	Non-Tracking Tack - to be used with T	GAL	No Bid
West Virginia Paving, Inc - Bluefield VA Plant	V	Lay Down of Materials - to be used with T - 400 Ton or Greater	TON	No Bid
West Virginia Paving, Inc - Bluefield VA Plant	W	Ultra-Thin Asphalt Overlay - SP498	TON	No Bid
West Virginia Paving, Inc - Bluefield VA Plant	X1	Fine Milling of Asphalt Pavement Surfaces - 0 to 250 Sq. Yards	SY	\$22.85
West Virginia Paving, Inc - Bluefield VA Plant	X2	Fine Milling of Asphalt Pavement Surfaces - 251 to 500 Sq. Yards	SY	\$17.85
West Virginia Paving, Inc - Bluefield VA Plant	X3	Fine Milling of Asphalt Pavement Surfaces - 501 to 1000 Sq. Yards	SY	\$12.85
West Virginia Paving, Inc - Bluefield VA Plant	X4	Fine Milling of Asphalt Pavement Surfaces 1001 to 2500 Sq. Yards	SY	\$6.70
West Virginia Paving, Inc - Bluefield VA Plant	X5	Fine Milling of Asphalt Pavement Surfaces 2501 to 5000 Sq. Yards	SY	\$4.85
West Virginia Paving, Inc - Bluefield VA Plant	X6	Fine Milling of Asphalt Pavement Surfaces - 5001 SY or Greater	SY	\$3.05
West Virginia Paving, Inc - Bluefield VA Plant	Y	Milled Rumble Strips	LF	\$0.50
	Z	Mobilization - Milled Rumble Strips - Complete on Attachment B (ATT B)	LUMP SUM	
West Virginia Paving, Inc - Bluefield VA Plant	AA	Surcharge for Parking Lot and Facility Paving - Items A	TON	\$7.00
West Virginia Paving, Inc - Bluefield VA Plant	AB	Cleaning and Sweeping	SY	\$0.01
West Virginia Paving, Inc - Bluefield VA Plant	AC1	Maintaining Traffic - Pilot Truck and Driver	DAY	\$900.00
West Virginia Paving, Inc - Bluefield VA Plant	AC2	Maintaining Traffic - Traffic Control Devices	UNIT	\$1.00
West Virginia Paving, Inc - Bluefield VA Plant	AC3	Maintaining Traffic - Flagger	HOUR	\$66.00
West Virginia Paving, Inc - Bluefield VA Plant	AC4	Maintaining Traffic - Arrow Board	DAY	\$30.00
West Virginia Paving, Inc - Bluefield VA Plant	AD1	Off-Season Plant Opening - First Day	DAY	\$3,500.00
West Virginia Paving, Inc - Bluefield VA Plant	AD2	Off-Season Plant Opening - Each Additional Day	DAY	\$1,000.00

Total Number of **Attachment A** pages submitted by Vendor is: 14

Asphalt Materials Delivery & Labor by Vendor by County

ATTACHMENT B MOBILIZATION PRICING PAGE (ATT B)

Vendor name shall be entered here by the Vendor:

West Virginia Paving, Inc.

Vendor Instructions: For bidding, Vendor shall enter below the Mobilization Item Pricing from Vendor's Sourced Plant Locations referenced on Attachment A Pricing Pages (ATT A). A complete set of pricing pages and plant information forms must be provided for each separate set of pricing (by county) submitted (ATT A, ATT B, ATT C, ATT D).

County	Unit of Measure	Item C, Mobilization Shoulder Stone	Item H1, Mobilization DAYTIME Paving	Item H2, Mobilization NIGHTTIME Paving	Item Q, Mobilization Pavement Profiling	Item Z, Mobilization Milled Rumble Strips
Barbour	LUMP SUM	\$ 1,800.00	\$ 1,000.00	\$ 10,000.00	\$ 3,500.00	\$ 3,500.00
Berkeley	LUMP SUM					
Boone	LUMP SUM	\$ 1,800.00	\$ 1,000.00	\$ 10,000.00	\$ 3,500.00	\$ 3,500.00
Braxton	LUMP SUM	\$ 1,800.00	\$ 1,000.00	\$ 10,000.00	\$ 3,500.00	\$ 3,500.00
Brooke	LUMP SUM					
Cabell	LUMP SUM	\$ 1,800.00	\$ 1,000.00	\$ 10,000.00	\$ 3,500.00	\$ 3,500.00
Calhoun	LUMP SUM	\$ 1,800.00	\$ 1,000.00	\$ 10,000.00	\$ 3,500.00	\$ 3,500.00
Clay	LUMP SUM	\$ 1,800.00	\$ 1,000.00	\$ 10,000.00	\$ 3,500.00	\$ 3,500.00
Doddridge	LUMP SUM					
Fayette	LUMP SUM	\$ 1,800.00	\$ 1,000.00	\$ 10,000.00	\$ 3,500.00	\$ 3,500.00
Gilmer	LUMP SUM	\$ 1,800.00	\$ 1,000.00	\$ 10,000.00	\$ 3,500.00	\$ 3,500.00
Grant	LUMP SUM	\$ 1,800.00	\$ 1,000.00	\$ 10,000.00	\$ 3,500.00	\$ 3,500.00
Greenbrier	LUMP SUM	\$ 1,800.00	\$ 1,000.00	\$ 10,000.00	\$ 3,500.00	\$ 3,500.00
Hampshire	LUMP SUM	\$ 1,800.00	\$ 1,000.00	\$ 10,000.00	\$ 3,500.00	\$ 3,500.00
Hancock	LUMP SUM					
Hardy	LUMP SUM	\$ 1,800.00	\$ 1,000.00	\$ 10,000.00	\$ 3,500.00	\$ 3,500.00
Harrison	LUMP SUM					
Jackson	LUMP SUM	\$ 1,800.00	\$ 1,000.00	\$ 10,000.00	\$ 3,500.00	\$ 3,500.00
Jefferson	LUMP SUM					
Kanawha	LUMP SUM	\$ 1,800.00	\$ 1,000.00	\$ 10,000.00	\$ 3,500.00	\$ 3,500.00
Lewis	LUMP SUM	\$ 1,800.00	\$ 1,000.00	\$ 10,000.00	\$ 3,500.00	\$ 3,500.00
Lincoln	LUMP SUM	\$ 1,800.00	\$ 1,000.00	\$ 10,000.00	\$ 3,500.00	\$ 3,500.00
Logan	LUMP SUM	\$ 1,800.00	\$ 1,000.00	\$ 10,000.00	\$ 3,500.00	\$ 3,500.00
Marion	LUMP SUM					
Marshall	LUMP SUM					
Mason	LUMP SUM	\$ 1,800.00	\$ 1,000.00	\$ 10,000.00	\$ 3,500.00	\$ 3,500.00
McDowell	LUMP SUM	\$ 1,800.00	\$ 1,000.00	\$ 10,000.00	\$ 3,500.00	\$ 3,500.00
Mercer	LUMP SUM	\$ 1,800.00	\$ 1,000.00	\$ 10,000.00	\$ 3,500.00	\$ 3,500.00
Mineral	LUMP SUM	\$ 1,800.00	\$ 1,000.00	\$ 10,000.00	\$ 3,500.00	\$ 3,500.00
Mingo	LUMP SUM	\$ 1,800.00	\$ 1,000.00	\$ 10,000.00	\$ 3,500.00	\$ 3,500.00
Monongalia	LUMP SUM					
Monroe	LUMP SUM	\$ 1,800.00	\$ 1,000.00	\$ 10,000.00	\$ 3,500.00	\$ 3,500.00
Morgan	LUMP SUM					
Nicholas	LUMP SUM	\$ 1,800.00	\$ 1,000.00	\$ 10,000.00	\$ 3,500.00	\$ 3,500.00
Ohio	LUMP SUM					
Pendleton	LUMP SUM	\$ 1,800.00	\$ 1,000.00	\$ 10,000.00	\$ 3,500.00	\$ 3,500.00
Pleasants	LUMP SUM	\$ 1,800.00	\$ 1,000.00	\$ 10,000.00	\$ 3,500.00	\$ 3,500.00
Pocahontas	LUMP SUM	\$ 1,800.00	\$ 1,000.00	\$ 10,000.00	\$ 3,500.00	\$ 3,500.00
Preston	LUMP SUM					
Putnam	LUMP SUM	\$ 1,800.00	\$ 1,000.00	\$ 10,000.00	\$ 3,500.00	\$ 3,500.00
Raleigh	LUMP SUM	\$ 1,800.00	\$ 1,000.00	\$ 10,000.00	\$ 3,500.00	\$ 3,500.00
Randolph	LUMP SUM	\$ 1,800.00	\$ 1,000.00	\$ 10,000.00	\$ 3,500.00	\$ 3,500.00
Ritchie	LUMP SUM	\$ 1,800.00	\$ 1,000.00	\$ 10,000.00	\$ 3,500.00	\$ 3,500.00
Roane	LUMP SUM	\$ 1,800.00	\$ 1,000.00	\$ 10,000.00	\$ 3,500.00	\$ 3,500.00
Summers	LUMP SUM	\$ 1,800.00	\$ 1,000.00	\$ 10,000.00	\$ 3,500.00	\$ 3,500.00
Taylor	LUMP SUM					
Tucker	LUMP SUM	\$ 1,800.00	\$ 1,000.00	\$ 10,000.00	\$ 3,500.00	\$ 3,500.00
Tyler	LUMP SUM					
Upshur	LUMP SUM	\$ 1,800.00	\$ 1,000.00	\$ 10,000.00	\$ 3,500.00	\$ 3,500.00
Wayne	LUMP SUM	\$ 1,800.00	\$ 1,000.00	\$ 10,000.00	\$ 3,500.00	\$ 3,500.00
Webster	LUMP SUM	\$ 1,800.00	\$ 1,000.00	\$ 10,000.00	\$ 3,500.00	\$ 3,500.00
Wetzel	LUMP SUM					
Wirt	LUMP SUM	\$ 1,800.00	\$ 1,000.00	\$ 10,000.00	\$ 3,500.00	\$ 3,500.00
Wood	LUMP SUM	\$ 1,800.00	\$ 1,000.00	\$ 10,000.00	\$ 3,500.00	\$ 3,500.00
Wyoming	LUMP SUM	\$ 1,800.00	\$ 1,000.00	\$ 10,000.00	\$ 3,500.00	\$ 3,500.00

Asphalt Materials Delivery & Labor by Vendor by County

ATTACHMENT B MOBILIZATION PRICING PAGE (ATT B)

Vendor name shall be entered here by the Vendor:

West Virginia Paving, Inc.

Vendor Instructions: For bidding, Vendor shall enter below the Mobilization Item Pricing from Vendor's Sourced Plant Locations referenced on Attachment A Pricing Pages (ATT A). A complete set of pricing pages and plant information forms must be provided for each separate set of pricing (by county) submitted (ATT A, ATT B, ATT C, ATT D).

County	Unit of Measure	Item C, Mobilization Shoulder Stone	Item H1, Mobilization DAYTIME Paving	Item H2, Mobilization NIGHTTIME Paving	Item Q, Mobilization Pavement Profiling	Item Z, Mobilization Milled Rumble Strips
Barbour	LUMP SUM	\$ 1,800.00	\$ 1,000.00	\$ 10,000.00	\$ 3,500.00	\$ 3,500.00
Berkeley	LUMP SUM					
Boone	LUMP SUM	\$ 1,800.00	\$ 1,000.00	\$ 10,000.00	\$ 3,500.00	\$ 3,500.00
Braxton	LUMP SUM	\$ 1,800.00	\$ 1,000.00	\$ 10,000.00	\$ 3,500.00	\$ 3,500.00
Brooke	LUMP SUM					
Cabell	LUMP SUM	\$ 1,800.00	\$ 1,000.00	\$ 10,000.00	\$ 3,500.00	\$ 3,500.00
Calhoun	LUMP SUM	\$ 1,800.00	\$ 1,000.00	\$ 10,000.00	\$ 3,500.00	\$ 3,500.00
Clay	LUMP SUM	\$ 1,800.00	\$ 1,000.00	\$ 10,000.00	\$ 3,500.00	\$ 3,500.00
Doddridge	LUMP SUM					
Fayette	LUMP SUM	\$ 1,800.00	\$ 1,000.00	\$ 10,000.00	\$ 3,500.00	\$ 3,500.00
Gilmer	LUMP SUM	\$ 1,800.00	\$ 1,000.00	\$ 10,000.00	\$ 3,500.00	\$ 3,500.00
Grant	LUMP SUM	\$ 1,800.00	\$ 1,000.00	\$ 10,000.00	\$ 3,500.00	\$ 3,500.00
Greenbrier	LUMP SUM	\$ 1,800.00	\$ 1,000.00	\$ 10,000.00	\$ 3,500.00	\$ 3,500.00
Hampshire	LUMP SUM	\$ 1,800.00	\$ 1,000.00	\$ 10,000.00	\$ 3,500.00	\$ 3,500.00
Hancock	LUMP SUM					
Hardy	LUMP SUM	\$ 1,800.00	\$ 1,000.00	\$ 10,000.00	\$ 3,500.00	\$ 3,500.00
Harrison	LUMP SUM					
Jackson	LUMP SUM	\$ 1,800.00	\$ 1,000.00	\$ 10,000.00	\$ 3,500.00	\$ 3,500.00
Jefferson	LUMP SUM					
Kanawha	LUMP SUM	\$ 1,800.00	\$ 1,000.00	\$ 10,000.00	\$ 3,500.00	\$ 3,500.00
Lewis	LUMP SUM	\$ 1,800.00	\$ 1,000.00	\$ 10,000.00	\$ 3,500.00	\$ 3,500.00
Lincoln	LUMP SUM	\$ 1,800.00	\$ 1,000.00	\$ 10,000.00	\$ 3,500.00	\$ 3,500.00
Logan	LUMP SUM	\$ 1,800.00	\$ 1,000.00	\$ 10,000.00	\$ 3,500.00	\$ 3,500.00
Marion	LUMP SUM					
Marshall	LUMP SUM					
Mason	LUMP SUM	\$ 1,800.00	\$ 1,000.00	\$ 10,000.00	\$ 3,500.00	\$ 3,500.00
McDowell	LUMP SUM	\$ 1,800.00	\$ 1,000.00	\$ 10,000.00	\$ 3,500.00	\$ 3,500.00
Mercer	LUMP SUM	\$ 1,800.00	\$ 1,000.00	\$ 10,000.00	\$ 3,500.00	\$ 3,500.00
Mineral	LUMP SUM	\$ 1,800.00	\$ 1,000.00	\$ 10,000.00	\$ 3,500.00	\$ 3,500.00
Mingo	LUMP SUM	\$ 1,800.00	\$ 1,000.00	\$ 10,000.00	\$ 3,500.00	\$ 3,500.00
Monongalia	LUMP SUM					
Monroe	LUMP SUM	\$ 1,800.00	\$ 1,000.00	\$ 10,000.00	\$ 3,500.00	\$ 3,500.00
Morgan	LUMP SUM					
Nicholas	LUMP SUM	\$ 1,800.00	\$ 1,000.00	\$ 10,000.00	\$ 3,500.00	\$ 3,500.00
Ohio	LUMP SUM					
Pendleton	LUMP SUM	\$ 1,800.00	\$ 1,000.00	\$ 10,000.00	\$ 3,500.00	\$ 3,500.00
Pleasants	LUMP SUM	\$ 1,800.00	\$ 1,000.00	\$ 10,000.00	\$ 3,500.00	\$ 3,500.00
Pocahontas	LUMP SUM	\$ 1,800.00	\$ 1,000.00	\$ 10,000.00	\$ 3,500.00	\$ 3,500.00
Preston	LUMP SUM					
Putnam	LUMP SUM	\$ 1,800.00	\$ 1,000.00	\$ 10,000.00	\$ 3,500.00	\$ 3,500.00
Raleigh	LUMP SUM	\$ 1,800.00	\$ 1,000.00	\$ 10,000.00	\$ 3,500.00	\$ 3,500.00
Randolph	LUMP SUM	\$ 1,800.00	\$ 1,000.00	\$ 10,000.00	\$ 3,500.00	\$ 3,500.00
Ritchie	LUMP SUM	\$ 1,800.00	\$ 1,000.00	\$ 10,000.00	\$ 3,500.00	\$ 3,500.00
Roane	LUMP SUM	\$ 1,800.00	\$ 1,000.00	\$ 10,000.00	\$ 3,500.00	\$ 3,500.00
Summers	LUMP SUM	\$ 1,800.00	\$ 1,000.00	\$ 10,000.00	\$ 3,500.00	\$ 3,500.00
Taylor	LUMP SUM					
Tucker	LUMP SUM	\$ 1,800.00	\$ 1,000.00	\$ 10,000.00	\$ 3,500.00	\$ 3,500.00
Tyler	LUMP SUM					
Upshur	LUMP SUM	\$ 1,800.00	\$ 1,000.00	\$ 10,000.00	\$ 3,500.00	\$ 3,500.00
Wayne	LUMP SUM	\$ 1,800.00	\$ 1,000.00	\$ 10,000.00	\$ 3,500.00	\$ 3,500.00
Webster	LUMP SUM	\$ 1,800.00	\$ 1,000.00	\$ 10,000.00	\$ 3,500.00	\$ 3,500.00
Wetzel	LUMP SUM					
Wirt	LUMP SUM	\$ 1,800.00	\$ 1,000.00	\$ 10,000.00	\$ 3,500.00	\$ 3,500.00
Wood	LUMP SUM	\$ 1,800.00	\$ 1,000.00	\$ 10,000.00	\$ 3,500.00	\$ 3,500.00
Wyoming	LUMP SUM	\$ 1,800.00	\$ 1,000.00	\$ 10,000.00	\$ 3,500.00	\$ 3,500.00

Asphalt Materials Delivery & Labor by Vendor by County
 ATTACHMENT C ASPHALT PLANT LOCATION INFORMATION FORM (ATT C)

Vendor name shall be entered here by the Vendor: West Virginia Paving - Gallipolis, Ohio

Vendor Instructions: For bidding, Vendor shall enter below the source ASPHALT Plant Names and Locations, including their 911 address. Vendor must list with each source Plant Name and Location listed the counties that plan will be used to service for this contract. Referece Section 7.2.2 for additional instructions. A complete set of pricing pages and plant information forms must be provided for each seperate set of pricing (by county) submitted (ATT A, ATT B, ATT C, ATT D).

Vendor's ASPHALT Plant Location for use with LAYDOWN services:	
This plant shall be sourced by the Vendor to serve the following counties and correspond with counties marked on Pricing Pages:	
County names:	Mason, Cabell, Jackson
Plant Name & Location	West Virginia Paving (Shelly Company)
	Rt. 7 North
	Gallipolis, Ohio 45631
Vendor's ASPHALT Plant Location for use with LAYDOWN services:	
This plant shall be sourced by the Vendor to serve the following counties and correspond with counties marked on Pricing Pages:	
County names:	
Plant Name & Location	
Vendor's ASPHALT Plant Location for use with LAYDOWN services:	
This plant shall be sourced by the Vendor to serve the following counties and correspond with counties marked on Pricing Pages:	
County names:	
Plant Name & Location	
Vendor's ASPHALT Plant Location for use with LAYDOWN services:	
This plant shall be sourced by the Vendor to serve the following counties and correspond with counties marked on Pricing Pages:	
County names:	
Plant Name & Location	

Asphalt Materials Delivery & Labor by Vendor by County
 ATTACHMENT C ASPHALT PLANT LOCATION INFORMATION FORM (ATT C)

Vendor name shall be entered here by the Vendor: West Virginia Paving - Ashland, KY

Vendor Instructions: For bidding, Vendor shall enter below the source ASPHALT Plant Names and Locations, including their 911 address. Vendor must list with each source Plant Name and Location listed the counties that plan will be used to service for this contract. Referece Section 7.2.2 for additional instructions. A complete set of pricing pages and plant information forms must be provided for each seperate set of pricing (by county) submitted (ATT A, ATT B, ATT C, ATT D).

Vendor's ASPHALT Plant Location for use with LAYDOWN services:	
This plant shall be sourced by the Vendor to serve the following counties and correspond with counties marked on Pricing Pages:	
County names:	Cabell, Lincoln, Wayne
Plant Name & Location	West Virginia Paving (Mountain Enterprises) Ashland KY Plant
	300 Greenup Ave
	Ashland, Ky 41101
Vendor's ASPHALT Plant Location for use with LAYDOWN services:	
This plant shall be sourced by the Vendor to serve the following counties and correspond with counties marked on Pricing Pages:	
County names:	
Plant Name & Location	
Vendor's ASPHALT Plant Location for use with LAYDOWN services:	
This plant shall be sourced by the Vendor to serve the following counties and correspond with counties marked on Pricing Pages:	
County names:	
Plant Name & Location	
Vendor's ASPHALT Plant Location for use with LAYDOWN services:	
This plant shall be sourced by the Vendor to serve the following counties and correspond with counties marked on Pricing Pages:	
County names:	
Plant Name & Location	

Asphalt Materials Delivery & Labor by Vendor by County
 ATTACHMENT C ASPHALT PLANT LOCATION INFORMATION FORM (ATT C)

Vendor name shall be entered here by the Vendor: West Virginia Paving - Dunbar & Poca, WV

Vendor Instructions: For bidding, Vendor shall enter below the source ASPHALT Plant Names and Locations, including their 911 address. Vendor must list with each source Plant Name and Location listed the counties that plan will be used to service for this contract. Referece Section 7.2.2 for additional instructions. A complete set of pricing pages and plant information forms must be provided for each seperate set of pricing (by county) submitted (ATT A, ATT B, ATT C, ATT D).

Vendor's ASPHALT Plant Location for use with LAYDOWN services:	
This plant shall be sourced by the Vendor to serve the following counties and correspond with counties marked on Pricing Pages:	
County names:	Kanawha, Putnam, Boone, Mason, Clay, Jackson, Roane, Calhoun, Fayette, Lincoln
Plant Name & Location	West Virginia Paving Dunbar Plant
	2902 Charles Ave.
	Dunbar, WV 25064
Vendor's ASPHALT Plant Location for use with LAYDOWN services:	
This plant shall be sourced by the Vendor to serve the following counties and correspond with counties marked on Pricing Pages:	
County names:	Kanawha, Putnam, Boone, Mason, Clay, Jackson, Roane, Calhoun, Fayette, Lincoln
Plant Name & Location	West Virginia Paving Poca Plant
	Wright Road
	Poca, WV 25159
Vendor's ASPHALT Plant Location for use with LAYDOWN services:	
This plant shall be sourced by the Vendor to serve the following counties and correspond with counties marked on Pricing Pages:	
County names:	
Plant Name & Location	
Vendor's ASPHALT Plant Location for use with LAYDOWN services:	
This plant shall be sourced by the Vendor to serve the following counties and correspond with counties marked on Pricing Pages:	
County names:	
Plant Name & Location	

Asphalt Materials Delivery & Labor by Vendor by County
 ATTACHMENT C ASPHALT PLANT LOCATION INFORMATION FORM (ATT C)

Vendor name shall be entered here by the Vendor: West Virginia Paving - Camden Materials, KY

Vendor Instructions: For bidding, Vendor shall enter below the source ASPHALT Plant Names and Locations, including their 911 address. Vendor must list with each source Plant Name and Location listed the counties that plan will be used to service for this contract. Referece Section 7.2.2 for additional instructions. A complete set of pricing pages and plant information forms must be provided for each seperate set of pricing (by county) submitted (ATT A, ATT B, ATT C, ATT D).

Vendor's ASPHALT Plant Location for use with LAYDOWN services:	
This plant shall be sourced by the Vendor to serve the following counties and correspond with counties marked on Pricing Pages:	
County names:	Jackson, Ritchie, Wirt, Wood, Pleasants, Roane, Calhoun
Plant Name & Location	Camden Materials
	202 Hickory Street
	Parkersburg, WV 26101
Vendor's ASPHALT Plant Location for use with LAYDOWN services:	
This plant shall be sourced by the Vendor to serve the following counties and correspond with counties marked on Pricing Pages:	
County names:	
Plant Name & Location	
Vendor's ASPHALT Plant Location for use with LAYDOWN services:	
This plant shall be sourced by the Vendor to serve the following counties and correspond with counties marked on Pricing Pages:	
County names:	
Plant Name & Location	
Vendor's ASPHALT Plant Location for use with LAYDOWN services:	
This plant shall be sourced by the Vendor to serve the following counties and correspond with counties marked on Pricing Pages:	
County names:	
Plant Name & Location	

Asphalt Materials Delivery & Labor by Vendor by County
 ATTACHMENT C ASPHALT PLANT LOCATION INFORMATION FORM (ATT C)

Vendor name shall be entered here by the Vendor: West Virginia Paving - Beaver, WV

Vendor Instructions: For bidding, Vendor shall enter below the source ASPHALT Plant Names and Locations, including their 911 address. Vendor must list with each source Plant Name and Location listed the counties that plan will be used to service for this contract. Referece Section 7.2.2 for additional instructions. A complete set of pricing pages and plant information forms must be provided for each seperate set of pricing (by county) submitted (ATT A, ATT B, ATT C, ATT D).

Vendor's ASPHALT Plant Location for use with LAYDOWN services:	
This plant shall be sourced by the Vendor to serve the following counties and correspond with counties marked on Pricing Pages:	
County names:	Fayette, McDowell, Mercer, Raleigh, Summers, Wyoming
Plant Name & Location	West Virginia Paving Beaver Plant
	195 Southern Industrial Drive
	Beaver, WV 25813
Vendor's ASPHALT Plant Location for use with LAYDOWN services:	
This plant shall be sourced by the Vendor to serve the following counties and correspond with counties marked on Pricing Pages:	
County names:	
Plant Name & Location	
Vendor's ASPHALT Plant Location for use with LAYDOWN services:	
This plant shall be sourced by the Vendor to serve the following counties and correspond with counties marked on Pricing Pages:	
County names:	
Plant Name & Location	
Vendor's ASPHALT Plant Location for use with LAYDOWN services:	
This plant shall be sourced by the Vendor to serve the following counties and correspond with counties marked on Pricing Pages:	
County names:	
Plant Name & Location	

Asphalt Materials Delivery & Labor by Vendor by County
 ATTACHMENT C ASPHALT PLANT LOCATION INFORMATION FORM (ATT C)

Vendor name shall be entered here by the Vendor: West Virginia Paving - Huntington, WV

Vendor Instructions: For bidding, Vendor shall enter below the source ASPHALT Plant Names and Locations, including their 911 address. Vendor must list with each source Plant Name and Location listed the counties that plan will be used to service for this contract. Referece Section 7.2.2 for additional instructions. A complete set of pricing pages and plant information forms must be provided for each seperate set of pricing (by county) submitted (ATT A, ATT B, ATT C, ATT D).

Vendor's ASPHALT Plant Location for use with LAYDOWN services:	
This plant shall be sourced by the Vendor to serve the following counties and correspond with counties marked on Pricing Pages:	
County names:	Cabell, Lincoln, Wayne, Mason
Plant Name & Location	West Virginia Paving Huntington Plant
	4022 Ohio River Rd
	Huntington, WV 25702
Vendor's ASPHALT Plant Location for use with LAYDOWN services:	
This plant shall be sourced by the Vendor to serve the following counties and correspond with counties marked on Pricing Pages:	
County names:	
Plant Name & Location	
Vendor's ASPHALT Plant Location for use with LAYDOWN services:	
This plant shall be sourced by the Vendor to serve the following counties and correspond with counties marked on Pricing Pages:	
County names:	
Plant Name & Location	
Vendor's ASPHALT Plant Location for use with LAYDOWN services:	
This plant shall be sourced by the Vendor to serve the following counties and correspond with counties marked on Pricing Pages:	
County names:	
Plant Name & Location	

Asphalt Materials Delivery & Labor by Vendor by County
 ATTACHMENT C ASPHALT PLANT LOCATION INFORMATION FORM (ATT C)

Vendor name shall be entered here by the Vendor: West Virginia Paving - Whitman, WV

Vendor Instructions: For bidding, Vendor shall enter below the source ASPHALT Plant Names and Locations, including their 911 address. Vendor must list with each source Plant Name and Location listed the counties that plan will be used to service for this contract. Referece Section 7.2.2 for additional instructions. A complete set of pricing pages and plant information forms must be provided for each seperate set of pricing (by county) submitted (ATT A, ATT B, ATT C, ATT D).

Vendor's ASPHALT Plant Location for use with LAYDOWN services:	
This plant shall be sourced by the Vendor to serve the following counties and correspond with counties marked on Pricing Pages:	
County names:	Lincoln, Logan, Mingo, Boone, McDowell, Wyoming, Wayne
Plant Name & Location	West Virginia Paving Whitman Plant
	US 119 Whitman Creek Road
	Whitman, WV 25652
Vendor's ASPHALT Plant Location for use with LAYDOWN services:	
This plant shall be sourced by the Vendor to serve the following counties and correspond with counties marked on Pricing Pages:	
County names:	
Plant Name & Location	
Vendor's ASPHALT Plant Location for use with LAYDOWN services:	
This plant shall be sourced by the Vendor to serve the following counties and correspond with counties marked on Pricing Pages:	
County names:	
Plant Name & Location	
Vendor's ASPHALT Plant Location for use with LAYDOWN services:	
This plant shall be sourced by the Vendor to serve the following counties and correspond with counties marked on Pricing Pages:	
County names:	
Plant Name & Location	

Asphalt Materials Delivery & Labor by Vendor by County
 ATTACHMENT C ASPHALT PLANT LOCATION INFORMATION FORM (ATT C)

Vendor name shall be entered here by the Vendor: West Virginia Paving - Elkins, WV

Vendor Instructions: For bidding, Vendor shall enter below the source ASPHALT Plant Names and Locations, including their 911 address. Vendor must list with each source Plant Name and Location listed the counties that plan will be used to service for this contract. Referece Section 7.2.2 for additional instructions. A complete set of pricing pages and plant information forms must be provided for each seperate set of pricing (by county) submitted (ATT A, ATT B, ATT C, ATT D).

Vendor's ASPHALT Plant Location for use with LAYDOWN services:	
This plant shall be sourced by the Vendor to serve the following counties and correspond with counties marked on Pricing Pages:	
County names:	Barbour, Lewis, Pendleton, Pocahontas, Randolph, Tucker, Upshur
Plant Name & Location	West Virginia Paving Elkins Plant
	Rt. 33 Kelly Mountain Road
	Elkins, WV 26241
Vendor's ASPHALT Plant Location for use with LAYDOWN services:	
This plant shall be sourced by the Vendor to serve the following counties and correspond with counties marked on Pricing Pages:	
County names:	
Plant Name & Location	
Vendor's ASPHALT Plant Location for use with LAYDOWN services:	
This plant shall be sourced by the Vendor to serve the following counties and correspond with counties marked on Pricing Pages:	
County names:	
Plant Name & Location	
Vendor's ASPHALT Plant Location for use with LAYDOWN services:	
This plant shall be sourced by the Vendor to serve the following counties and correspond with counties marked on Pricing Pages:	
County names:	
Plant Name & Location	

Asphalt Materials Delivery & Labor by Vendor by County
 ATTACHMENT C ASPHALT PLANT LOCATION INFORMATION FORM (ATT C)

Vendor name shall be entered here by the Vendor: West Virginia Paving - Princeton, WV

Vendor Instructions: For bidding, Vendor shall enter below the source ASPHALT Plant Names and Locations, including their 911 address. Vendor must list with each source Plant Name and Location listed the counties that plan will be used to service for this contract. Referece Section 7.2.2 for additional instructions. A complete set of pricing pages and plant information forms must be provided for each seperate set of pricing (by county) submitted (ATT A, ATT B, ATT C, ATT D).

Vendor's ASPHALT Plant Location for use with LAYDOWN services:	
This plant shall be sourced by the Vendor to serve the following counties and correspond with counties marked on Pricing Pages:	
County names:	Mercer, McDowell, Wyoming, Raleigh, Summers
Plant Name & Location	West Virginia Paving Princeton Plant
	6941 Ingleside Drive
	Princeton, WV 24740
Vendor's ASPHALT Plant Location for use with LAYDOWN services:	
This plant shall be sourced by the Vendor to serve the following counties and correspond with counties marked on Pricing Pages:	
County names:	
Plant Name & Location	
Vendor's ASPHALT Plant Location for use with LAYDOWN services:	
This plant shall be sourced by the Vendor to serve the following counties and correspond with counties marked on Pricing Pages:	
County names:	
Plant Name & Location	
Vendor's ASPHALT Plant Location for use with LAYDOWN services:	
This plant shall be sourced by the Vendor to serve the following counties and correspond with counties marked on Pricing Pages:	
County names:	
Plant Name & Location	

Asphalt Materials Delivery & Labor by Vendor by County
 ATTACHMENT C ASPHALT PLANT LOCATION INFORMATION FORM (ATT C)

Vendor name shall be entered here by the Vendor: West Virginia Paving - Ripley, WV

Vendor Instructions: For bidding, Vendor shall enter below the source ASPHALT Plant Names and Locations, including their 911 address. Vendor must list with each source Plant Name and Location listed the counties that plan will be used to service for this contract. Referece Section 7.2.2 for additional instructions. A complete set of pricing pages and plant information forms must be provided for each seperate set of pricing (by county) submitted (ATT A, ATT B, ATT C, ATT D).

Vendor's ASPHALT Plant Location for use with LAYDOWN services:	
This plant shall be sourced by the Vendor to serve the following counties and correspond with counties marked on Pricing Pages:	
County names:	Jackson, Roane, Wood, Mason, Putnam, Calhoun
Plant Name & Location	West Virginia Paving Ripley Plant
	2187 Ripley Road
	Ripley, WV 25271
Vendor's ASPHALT Plant Location for use with LAYDOWN services:	
This plant shall be sourced by the Vendor to serve the following counties and correspond with counties marked on Pricing Pages:	
County names:	
Plant Name & Location	
Vendor's ASPHALT Plant Location for use with LAYDOWN services:	
This plant shall be sourced by the Vendor to serve the following counties and correspond with counties marked on Pricing Pages:	
County names:	
Plant Name & Location	
Vendor's ASPHALT Plant Location for use with LAYDOWN services:	
This plant shall be sourced by the Vendor to serve the following counties and correspond with counties marked on Pricing Pages:	
County names:	
Plant Name & Location	

Asphalt Materials Delivery & Labor by Vendor by County
 ATTACHMENT C ASPHALT PLANT LOCATION INFORMATION FORM (ATT C)

Vendor name shall be entered here by the Vendor: West Virginia Paving - Bluefield, VA

Vendor Instructions: For bidding, Vendor shall enter below the source ASPHALT Plant Names and Locations, including their 911 address. Vendor must list with each source Plant Name and Location listed the counties that plan will be used to service for this contract. Referece Section 7.2.2 for additional instructions. A complete set of pricing pages and plant information forms must be provided for each seperate set of pricing (by county) submitted (ATT A, ATT B, ATT C, ATT D).

Vendor's ASPHALT Plant Location for use with LAYDOWN services:	
This plant shall be sourced by the Vendor to serve the following counties and correspond with counties marked on Pricing Pages:	
County names:	Mercer, McDowell, Wyoming
Plant Name & Location	West Virginia Paving Bluefield VA Plant
	2967 Virginia Ave.
	Bluefield, VA 24605
Vendor's ASPHALT Plant Location for use with LAYDOWN services:	
This plant shall be sourced by the Vendor to serve the following counties and correspond with counties marked on Pricing Pages:	
County names:	
Plant Name & Location	
Vendor's ASPHALT Plant Location for use with LAYDOWN services:	
This plant shall be sourced by the Vendor to serve the following counties and correspond with counties marked on Pricing Pages:	
County names:	
Plant Name & Location	
Vendor's ASPHALT Plant Location for use with LAYDOWN services:	
This plant shall be sourced by the Vendor to serve the following counties and correspond with counties marked on Pricing Pages:	
County names:	
Plant Name & Location	

Asphalt Materials Delivery & Labor by Vendor by County
ATTACHMENT D STONE PLANT LOCATION INFORMATION FORM (ATT D)

Vendor name shall be entered here by the Vendor: West Virginia Paving, Inc.

Vendor Instructions: For bidding, Vendor shall enter below the **STONE** source Plant Names and Locations, including their 911 address. Vendor must list with each source Plant Name and Location listed the counties that plan will be used to service for this contract. Referece Section 7.2.2 for additional instructions. A complete set of Pricing Pages and Plant Information Forms must be provided for each seperate set of pricing (by county) submitted (ATT A, ATT B, ATT C, ATT D).

Vendor's SHOULDER STONE Plant Location for use with LAYDOWN services:	
This plant shall be sourced by the Vendor to serve the following counties and correspond with counties marked on Pricing Pages:	
County names:	Wood, Jackson, Wirt, Ritchie, Calhoun, Pleasants
Plant Name & Location	Martin Marietta
	99 Kanawha Street
	Parkersburg, WV 26161
Vendor's SHOULDER STONE Plant Location for use with LAYDOWN services:	
This plant shall be sourced by the Vendor to serve the following counties and correspond with counties marked on Pricing Pages:	
County names:	Kanawha, Boone, Lincoln, Putnam, Mason, Clay, Roane, Calhoun
Plant Name & Location	Shamblin Stone
	Wilson Island
	70 Dunbar Ave
	Dunbar, WV 25064
Vendor's SHOULDER STONE Plant Location for use with LAYDOWN services:	
This plant shall be sourced by the Vendor to serve the following counties and correspond with counties marked on Pricing Pages:	
County names:	Kanawha, Boone, Lincoln, Putnam, Mason, Clay, Roane, Calhoun
Plant Name & Location	Shamblin Stone
	658 Winfield Road
	St. Albans, WV 25177
Vendor's SHOULDER STONE Plant Location for use with LAYDOWN services:	
This plant shall be sourced by the Vendor to serve the following counties and correspond with counties marked on Pricing Pages:	
County names:	
Plant Name & Location	

Asphalt Materials Delivery & Labor by Vendor by County
ATTACHMENT D STONE PLANT LOCATION INFORMATION FORM (ATT D)

Vendor name shall be entered here by the Vendor: West Virginia Paving, Inc.

Vendor Instructions: For bidding, Vendor shall enter below the **STONE** source Plant Names and Locations, including their 911 address. Vendor must list with each source Plant Name and Location listed the counties that plan will be used to service for this contract. Referece Section 7.2.2 for additional instructions. A complete set of Pricing Pages and Plant Information Forms must be provided for each separte set of pricing (by county) submitted (ATT A, ATT B, ATT C, ATT D).

Vendor's SHOULDER STONE Plant Location for use with LAYDOWN services:	
This plant shall be sourced by the Vendor to serve the following counties and correspond with counties marked on Pricing Pages:	
County names:	Cabell, Wayne, Lincoln, Mason
Plant Name & Location	West Virginia Paving, Inc. 4022 Ohio River Huntington, WV 25702
Vendor's SHOULDER STONE Plant Location for use with LAYDOWN services:	
This plant shall be sourced by the Vendor to serve the following counties and correspond with counties marked on Pricing Pages:	
County names:	Lincoln, Logan, Mingo
Plant Name & Location	West Virginia Paving, Inc. US119 Whitman Crk Road Whitman, WV 25652
Vendor's SHOULDER STONE Plant Location for use with LAYDOWN services:	
This plant shall be sourced by the Vendor to serve the following counties and correspond with counties marked on Pricing Pages:	
County names:	Mason, Jackson
Plant Name & Location	West Virginia Paving, Inc. Rt. 7 North Gallipolis, Ohio 45631
Vendor's SHOULDER STONE Plant Location for use with LAYDOWN services:	
This plant shall be sourced by the Vendor to serve the following counties and correspond with counties marked on Pricing Pages:	
County names:	Mason, Jackson, Wood, Roane, Calhoun
Plant Name & Location	Valley Stone Yard 360 Valley Road Millwood, WV 25262

Asphalt Materials Delivery & Labor by Vendor by County
ATTACHMENT D STONE PLANT LOCATION INFORMATION FORM (ATT D)

Vendor name shall be entered here by the Vendor: West Virginia Paving, Inc.

Vendor Instructions: For bidding, Vendor shall enter below the **STONE** source Plant Names and Locations, including their 911 address. Vendor must list with each source Plant Name and Location listed the counties that plan will be used to service for this contract. Referece Section 7.2.2 for additional instructions. A complete set of Pricing Pages and Plant Information Forms must be provided for each sepearte set of pricing (by county) submitted (ATT A, ATT B, ATT C, ATT D).

Vendor's SHOULDER STONE Plant Location for use with LAYDOWN services:	
This plant shall be sourced by the Vendor to serve the following counties and correspond with counties marked on Pricing Pages:	
County names:	Greenbrier, Summers, Monroe, Fayette
Plant Name & Location	Appalachian Aggregate
	21071 Midland Trail, West
	Lewisburg, WV 24901
Vendor's SHOULDER STONE Plant Location for use with LAYDOWN services:	
This plant shall be sourced by the Vendor to serve the following counties and correspond with counties marked on Pricing Pages:	
County names:	Greenbrier, Nicholas, Pocahontas, Webster, Braxton, Gilmer
Plant Name & Location	Appalachian Aggregate
	400 Stamping Crk Road
	Hillsboro, WV 25880
Vendor's SHOULDER STONE Plant Location for use with LAYDOWN services:	
This plant shall be sourced by the Vendor to serve the following counties and correspond with counties marked on Pricing Pages:	
County names:	Raleigh, Fayette, Wyoming, Nicholas
Plant Name & Location	Appalachian Aggregate
	1700 North Sandbranch Road
	Mt. Hope, WV 25880
Vendor's SHOULDER STONE Plant Location for use with LAYDOWN services:	
This plant shall be sourced by the Vendor to serve the following counties and correspond with counties marked on Pricing Pages:	
County names:	Mercer, Summers, McDowell, Wyoming
Plant Name & Location	Appalachian Aggregate
	Ingleside Drive
	Princeton, WV 24740

Asphalt Materials Delivery & Labor by Vendor by County
ATTACHMENT D STONE PLANT LOCATION INFORMATION FORM (ATT D)

Vendor name shall be entered here by the Vendor: West Virginia Paving, Inc.

Vendor Instructions: For bidding, Vendor shall enter below the **STONE** source Plant Names and Locations, including their 911 address. Vendor must list with each source Plant Name and Location listed the counties that plan will be used to service for this contract. Referece Section 7.2.2 for additional instructions. A complete set of Pricing Pages and Plant Information Forms must be provided for each seperate set of pricing (by county) submitted (ATT A, ATT B, ATT C, ATT D).

Vendor's SHOULDER STONE Plant Location for use with LAYDOWN services:	
This plant shall be sourced by the Vendor to serve the following counties and correspond with counties marked on Pricing Pages:	
County names:	Randolph, Pendleton, Pocahontas, Tucker, Lewis, Barbour, Upshur
Plant Name & Location	Appalachian Aggregate
	Route 33 East
	Elkins, WV 26241
Vendor's SHOULDER STONE Plant Location for use with LAYDOWN services:	
This plant shall be sourced by the Vendor to serve the following counties and correspond with counties marked on Pricing Pages:	
County names:	Hardy, Hampshie, Grant, Mineral, Tucker, Pendleton
Plant Name & Location	Fairfax Materials, Inc
	Greenland Gap Road
	Scherr, WV 26726
Vendor's SHOULDER STONE Plant Location for use with LAYDOWN services:	
This plant shall be sourced by the Vendor to serve the following counties and correspond with counties marked on Pricing Pages:	
County names:	
Plant Name & Location	
Vendor's SHOULDER STONE Plant Location for use with LAYDOWN services:	
This plant shall be sourced by the Vendor to serve the following counties and correspond with counties marked on Pricing Pages:	
County names:	
Plant Name & Location	