

Greenbrier Excavating & Paving, Inc.
232 Rambler Road
Lewisburg, WV 24901

Sealed Bid: 6621C044 – Asphalt Material, De

By Vender By County

Buyer: Tina Lewis

Solicitation Number: ARFQ 0803 DOT2100000029

Bid Opening Date: 02/18/2021

Bid Opening Time: 2:30pm





**State of West Virginia
Agency Request for Quote**

Proc Folder: 823541		Reason for Modification:	
Doc Description: Addendum#1 Asphalt Material, Delivery & Labor by Vendor		Addendum #1 To correct the bid opening date on the instructions to vendor form	
Proc Type: Agency Master Agreement			
Date Issued	Solicitation Closes	Solicitation No	Version
2021-02-02	2021-02-18 14:30	ARFQ 0803 DOT2100000029	2

BID RECEIVING LOCATION

FINANCE & ADMINISTRATION
DIVISION OF HIGHWAYS
BLDG 5, RM A-220
1900 KANAWHA BLVD E
CHARLESTON WV 25302
US

VENDOR

Vendor Customer Code: 000000204845
Vendor Name: Greenbrier Excavating & Paving, Inc
Address: 232
Street: Rambler Road
City: Lewisburg
State: West Virginia **Country:** United States **Zip:** 24901
Principal Contact: William Alan O'Brien
Vendor Contact Phone: 304-647-4296 **Extension:**

FOR INFORMATION CONTACT THE BUYER

Tina L Lewis
304-414-6859
tina.l.lewis@wv.gov

Vendor Signature X 

FEIN# 55-0635695

DATE 2/16/2021

All offers subject to all terms and conditions contained in this solicitation

INVOICE TO	SHIP TO
VARIOUS AGENCY LOCATIONS AS INDICATED BY ORDER	VARIOUS AGENCY LOCATIONS AS INDICATED BY ORDER
No City WV 99999 US	No City WV 99999 US

Line	Comm Ln Desc	Qty	Unit Issue	Unit Price	Total Price
2	Asphalt	0.00000	SY		

Comm Code	Manufacturer	Specification	Model #
30121601			

Extended Description:
Asphalt

SCHEDULE OF EVENTS

<u>Line</u>	<u>Event</u>	<u>Event Date</u>
1	TECHNICAL QUESTIONS DUE BY 10:00AM	2021-02-05

	Document Phase	Document Description	Page 3
DOT2100000029	Final	Addendum#1 Asphalt Material, Delivery & Labor by Vendor	

ADDITIONAL TERMS AND CONDITIONS

See attached document(s) for additional Terms and Conditions

Asphalt Materials Delivery & Labor by Vendor by County

ATTACHMENT A PRICING PAGE (ATT A)

Vendor name shall be entered here by the Vendor: Greenbrier Excavating & Paving, Inc.

Vendor Instructions: For bidding, Vendor shall mark with an "X" the counties that correspond with the pricing on this page. If Vendor has varied pricing per county, Vendor shall complete a separate set of Pricing Pages (ATT A and ATT B) as well as separate Plant Information Forms (ATT C & ATT D) for each county pricing set. Vendor must complete TWO Pricing Pages (ATT A and ATT B) as well as all Plant Information Forms for each pricing set submitted.

<input type="checkbox"/> Barbour	<input type="checkbox"/> Doddridge	<input type="checkbox"/> Harrison	<input type="checkbox"/> Marshall	<input type="checkbox"/> Morgan	<input checked="" type="checkbox"/> Raleigh	<input type="checkbox"/> Upshur
<input type="checkbox"/> Berkeley	<input checked="" type="checkbox"/> Fayette	<input type="checkbox"/> Jackson	<input type="checkbox"/> Mason	<input checked="" type="checkbox"/> Nicholas	<input type="checkbox"/> Randolph	<input type="checkbox"/> Wayne
<input type="checkbox"/> Boone	<input type="checkbox"/> Gilmer	<input type="checkbox"/> Jefferson	<input type="checkbox"/> McDowell	<input type="checkbox"/> Ohio	<input type="checkbox"/> Ritchie	<input type="checkbox"/> Webster
<input type="checkbox"/> Braxton	<input type="checkbox"/> Grant	<input type="checkbox"/> Kanawha	<input type="checkbox"/> Mercer	<input type="checkbox"/> Pendleton	<input type="checkbox"/> Roane	<input type="checkbox"/> Wetzel
<input type="checkbox"/> Brooke	<input checked="" type="checkbox"/> Greenbrier	<input type="checkbox"/> Lewis	<input type="checkbox"/> Mineral	<input type="checkbox"/> Pleasants	<input checked="" type="checkbox"/> Summers	<input type="checkbox"/> Wirt
<input type="checkbox"/> Cabell	<input type="checkbox"/> Hampshire	<input type="checkbox"/> Lincoln	<input type="checkbox"/> Mingo	<input checked="" type="checkbox"/> Pocahontas	<input type="checkbox"/> Taylor	<input type="checkbox"/> Wood
<input type="checkbox"/> Calhoun	<input type="checkbox"/> Hancock	<input type="checkbox"/> Logan	<input type="checkbox"/> Monongalia	<input type="checkbox"/> Preston	<input type="checkbox"/> Tucker	<input type="checkbox"/> Wyoming
<input type="checkbox"/> Clay	<input type="checkbox"/> Hardy	<input type="checkbox"/> Marion	<input checked="" type="checkbox"/> Monroe	<input type="checkbox"/> Putnam	<input type="checkbox"/> Tyler	

Supplier Name - Vendor's Sourced Plant	Contract Item #	Contract Item Description	Unit of Measure	List Price
	A1	Asphalt Section 401 - Base I	TON	\$48.00
	A2	Asphalt Section 401 - 25mm Superpave	TON	No Bid
	A3	Asphalt Section 401 - Base II	TON	\$52.10
	A4	Asphalt Section 401 - Patch and Level	TON	\$52.10
	A5	Asphalt Section 401 - Wearing IV	TON	\$53.00
	A6	Asphalt Section 402 - Wearing IV	TON	No Bid
	A7	Asphalt Section 401 - 19mm Superpave	TON	No Bid
	A8	Asphalt Section 401 - Scratch Course	TON	\$51.50
	A9	Asphalt Section 402 - 9.5mm Superpave	TON	No Bid
	A10	Asphalt Section 401 - Wearing 1	TON	\$51.50
	A11	Asphalt Section 402 - Wearing 1	TON	\$66.00
	A12	Asphalt Section 401 - 4.75mm Superpave	TON	No Bid
	A13	Asphalt Section 402 - 4.75mm Superpave	TON	No Bid
	A14	Asphalt Section 401 - Wearing III	TON	No Bid
	A15	Asphalt Section 402 - Wearing III	TON	No Bid
	A16	Asphalt Section 401 - 12.5mm Superpave	TON	No Bid
	A17	Asphalt Section 402 - 12.5mm Superpave	TON	No Bid
	B	Shoulder Stone Placement for Asphalt Section 307 - Class 10	TON	\$46.00
	C	Shoulder Stone Mobilization - Complete on Attachment B (ATT B)	LUMP SUM	-----
	D1	Haul by Vendor Shoulder Stone Placement - First Ton Mile	MILE	\$1.50
	D2	Haul by Vendor Shoulder Stone Placement - Each Additional Mile	MILE	\$0.20
	E1	Surcharge for PG Binder - 70 minus 22	TON	\$5.00
	E2	Surcharge for PG Binder 76 minus 22 ordered in 400 Ton increments	TON	\$12.00
	F1	Asphalt Haul by Vendor - First Ton Mile	MILE	\$1.50
	F2	Asphalt Haul by Vendor - Each Additional Mile	MILE	\$0.20
	G1	Laydown of Materials. Items A and U, Each Site 0 to 100 Tons	TON	\$64.00
	G2	Laydown of Materials. Items A and U, Each Site 101 to 200 Tons	TON	\$24.00
	G3	Laydown of Materials. Items A and U, Each Site 201 to 500 Tons	TON	\$9.00
	G4	Laydown of Materials. Items A and U, Each Site 501 Tons or Greater	TON	\$8.50
	H1	Mobilization - Daytime Paving - Complete on Attachment B (ATT B)	LUMP SUM	-----
	H2	Mobilization - Nighttime Paving - Complete on Attachment B (ATT B)	LUMP SUM	-----
	I1	Excavation for Shoulder Paving - 0 to 1000 Sq. Yards	SY	\$5.50
	I2	Excavation for Shoulder Paving - 1001 to 2000 Sq. Yards	SY	\$3.50
	I3	Excavation for Shoulder Paving - 2001 to 3000 Sq. Yards	SY	\$2.50
	I4	Excavation for Shoulder Paving - 3001 Sq. Yards or Greater	SY	\$1.50
	J1	Asphalt Base I Shoulder Paving Surcharge - 0 to 100 Tons	TON	\$20.00
	J2	Asphalt Base I Shoulder Paving Surcharge - 101 to 200 Tons	TON	\$15.00
	J3	Asphalt Base I Shoulder Paving Surcharge - 201 to 500 Tons	TON	\$4.00
	J4	Asphalt Base I Shoulder Paving Surcharge - 501 Tons or Greater	TON	\$2.00
	K1	Asphalt Base II Shoulder Paving Surcharge - 0 to 100 Tons	TON	\$20.00
	K2	Asphalt Base II Shoulder Paving Surcharge - 101 to 200 Tons	TON	\$15.00
	K3	Asphalt Base II Shoulder Paving Surcharge - 201 to 500 Tons	TON	\$4.00
	K4	Asphalt Base II Shoulder Paving Surcharge - 501 Tons or Greater	TON	\$2.00
	L	Asphalt Material for Tack Coat or Prime Material	GAL	\$2.50
	M	Additional Heel-In Joints	LF	\$12.00
	N	Skip Paving Surcharge	TON	\$4.50
	O1	Pavement Profiling/Milling - 0 to 250 Sq. Yards	SY	\$20.00
	O2	Pavement Profiling/Milling - 251 to 500 Sq. Yards	SY	\$15.00
	O3	Pavement Profiling/Milling - 501 to 1000 Sq. Yards	SY	\$10.00
	O4	Pavement Profiling/Milling - 1001 to 2500 Sq. Yards	SY	\$5.00
	O5	Pavement Profiling/Milling - 2501 to 5000 Sq. Yards	SY	\$3.10
	O6	Pavement Profiling/Milling - 5001 Sq. Yards or Greater	SY	\$2.00
	P	Mobilization - Pavement Profiling/Milling - Complete on Attachment B (ATT B)	LUMP SUM	-----
	Q1	Haul of Profiled/Milled Cuttings, First 10 Miles (Included with Contract Items O)	MILE	No Add'l Charge
	Q2	Haul of Profiled/Milled Cuttings, Each Additional Mile (Above 10 Miles)	LOADED MILE	\$2.00
	R	Pavement Repair - Asphalt Base II	TON	\$325.00
	S	Asphalt HPTO - SP496 - PG 64E-22 ordered 400 Ton increments	TON	\$135.00
	T	Non-Tracking Tack - to be used with S	GAL	\$4.50
	U	Lay Down of Materials - to be used with S - 400 Ton or Greater	TON	\$15.00
	V	Ultra-Thin Asphalt Overlay - SP498	TON	\$110.00

Asphalt Materials Delivery & Labor by Vendor by County

ATTACHMENT A PRICING PAGE (ATT A)

Vendor name shall be entered here by the Vendor: Greenbrier Excavating & Paving, Inc.

Vendor Instructions: For bidding, Vendor shall mark with an "X" the counties that correspond with the pricing on this page. If Vendor has varied pricing per county, Vendor shall complete a separate set of Pricing Pages (ATT A and ATT B) as well as separate Plant Information Forms (ATT C & ATT D) for each county pricing set. Vendor must complete TWO Pricing Pages (ATT A and ATT B) as well as all Plant Information Forms for each pricing set submitted.

<input type="checkbox"/> Barbour	<input type="checkbox"/> Doddridge	<input type="checkbox"/> Harrison	<input type="checkbox"/> Marshall	<input type="checkbox"/> Morgan	<input checked="" type="checkbox"/> Raleigh	<input type="checkbox"/> Upshur
<input type="checkbox"/> Berkeley	<input checked="" type="checkbox"/> Fayette	<input type="checkbox"/> Jackson	<input type="checkbox"/> Mason	<input checked="" type="checkbox"/> Nicholas	<input type="checkbox"/> Randolph	<input type="checkbox"/> Wayne
<input type="checkbox"/> Boone	<input type="checkbox"/> Gilmer	<input type="checkbox"/> Jefferson	<input type="checkbox"/> McDowell	<input type="checkbox"/> Ohio	<input type="checkbox"/> Ritchie	<input type="checkbox"/> Webster
<input type="checkbox"/> Braxton	<input type="checkbox"/> Grant	<input type="checkbox"/> Kanawha	<input type="checkbox"/> Mercer	<input type="checkbox"/> Pendleton	<input type="checkbox"/> Roane	<input type="checkbox"/> Wetzel
<input type="checkbox"/> Brooke	<input checked="" type="checkbox"/> Greenbrier	<input type="checkbox"/> Lewis	<input type="checkbox"/> Mineral	<input type="checkbox"/> Pleasants	<input checked="" type="checkbox"/> Summers	<input type="checkbox"/> Wirt
<input type="checkbox"/> Cabell	<input type="checkbox"/> Hampshire	<input type="checkbox"/> Lincoln	<input type="checkbox"/> Mingo	<input checked="" type="checkbox"/> Pocahontas	<input type="checkbox"/> Taylor	<input type="checkbox"/> Wood
<input type="checkbox"/> Calhoun	<input type="checkbox"/> Hancock	<input type="checkbox"/> Logan	<input type="checkbox"/> Monongalia	<input type="checkbox"/> Preston	<input type="checkbox"/> Tucker	<input type="checkbox"/> Wyoming
<input type="checkbox"/> Clay	<input type="checkbox"/> Hardy	<input type="checkbox"/> Marion	<input checked="" type="checkbox"/> Monroe	<input type="checkbox"/> Putnam	<input type="checkbox"/> Tyler	

Supplier Name - Vendor's Sourced Plant	Contract Item #	Contract Item Description	Unit of Measure	List Price
	W1	Fine Milling of Asphalt Pavement Surfaces - 0 to 250 Sq. Yards	SY	\$22.00
	W2	Fine Milling of Asphalt Pavement Surfaces - 251 to 500 Sq. Yards	SY	\$17.00
	W3	Fine Milling of Asphalt Pavement Surfaces - 501 to 1000 Sq. Yards	SY	\$12.00
	W4	Fine Milling of Asphalt Pavement Surfaces 1001 to 2500 Sq. Yards	SY	\$5.85
	W5	Fine Milling of Asphalt Pavement Surfaces 2501 to 5000 Sq. Yards	SY	\$4.00
	W6	Fine Milling of Asphalt Pavement Surfaces - 5001 SY or Greater	SY	\$2.20
	X	Milled Rumble Strips	LF	\$0.50
	Y	Mobilization - Milled Rumble Strips - Complete on Attachment B (ATT B)	LUMP SUM	
	Z	Surcharge for Parking Lot and Facility Paving	TON	\$7.00
	AA	Cleaning and Sweeping	SY	\$0.01
	AB1	Maintaining Traffic - Pilot Truck and Driver	DAY	\$900.00
	AB2	Maintaining Traffic - Traffic Control Devices	UNIT	\$1.00
	AB3	Maintaining Traffic - Flagger	HOURLY	\$65.00
	AB4	Maintaining Traffic - Arrow Board	DAY	\$30.00
	AC1	Off-Season Plant Opening - First Day	DAY	\$3,500.00
	AC2	Off-Season Plant Opening - Each Additional Day	DAY	\$1,000.00

Total Number of Attachment A pages submitted by Vendor is: 1

Asphalt Materials Delivery & Labor by Vendor by County

ATTACHMENT B MOBILIZATION PRICING PAGE (ATT B)

Vendor name shall be entered here by the Vendor:

Greenbrier Excavating and Paving, Inc.

Vendor Instructions: For bidding, Vendor shall enter below the Mobilization Item Pricing from Vendor's Sourced Plant Locations referenced on Attachment A Pricing Pages (ATT A). A complete set of pricing pages and plant information forms must be provided for each separate set of pricing (by county) submitted (ATT A, ATT B, ATT C, ATT D).

County	Unit of Measure	Item C, Mobilization Shoulder Stone	Item H1, Mobilization DAYTIME Paving	Item H2, Mobilization NIGHTTIME Paving	Item P, Mobilization Pavement Profiling	Item Y, Mobilization Milled Rumble Strips
Barbour	LUMP SUM	No Bid	No Bid	No Bid	No Bid	No Bid
Berkeley	LUMP SUM	No Bid	No Bid	No Bid	No Bid	No Bid
Boone	LUMP SUM	No Bid	No Bid	No Bid	No Bid	No Bid
Braxton	LUMP SUM	No Bid	No Bid	No Bid	No Bid	No Bid
Brooke	LUMP SUM	No Bid	No Bid	No Bid	No Bid	No Bid
Cabell	LUMP SUM	No Bid	No Bid	No Bid	No Bid	No Bid
Calhoun	LUMP SUM	No Bid	No Bid	No Bid	No Bid	No Bid
Clay	LUMP SUM	No Bid	No Bid	No Bid	No Bid	No Bid
Doddridge	LUMP SUM	No Bid	No Bid	No Bid	No Bid	No Bid
Fayette	LUMP SUM	\$ 1,800.00	\$ 1,000.00	\$ 4,000.00	\$ 3,500.00	\$ 3,500.00
Gilmer	LUMP SUM	No Bid	No Bid	No Bid	No Bid	No Bid
Grant	LUMP SUM	No Bid	No Bid	No Bid	No Bid	No Bid
Greenbrier	LUMP SUM	\$ 1,800.00	\$ 1,000.00	\$ 4,000.00	\$ 3,500.00	\$ 3,500.00
Hampshire	LUMP SUM	No Bid	No Bid	No Bid	No Bid	No Bid
Hancock	LUMP SUM	No Bid	No Bid	No Bid	No Bid	No Bid
Hardy	LUMP SUM	No Bid	No Bid	No Bid	No Bid	No Bid
Harrison	LUMP SUM	No Bid	No Bid	No Bid	No Bid	No Bid
Jackson	LUMP SUM	No Bid	No Bid	No Bid	No Bid	No Bid
Jefferson	LUMP SUM	No Bid	No Bid	No Bid	No Bid	No Bid
Kanawha	LUMP SUM	No Bid	No Bid	No Bid	No Bid	No Bid
Lewis	LUMP SUM	No Bid	No Bid	No Bid	No Bid	No Bid
Lincoln	LUMP SUM	No Bid	No Bid	No Bid	No Bid	No Bid
Logan	LUMP SUM	No Bid	No Bid	No Bid	No Bid	No Bid
Marion	LUMP SUM	No Bid	No Bid	No Bid	No Bid	No Bid
Marshall	LUMP SUM	No Bid	No Bid	No Bid	No Bid	No Bid
Mason	LUMP SUM	No Bid	No Bid	No Bid	No Bid	No Bid
McDowell	LUMP SUM	No Bid	No Bid	No Bid	No Bid	No Bid
Mercer	LUMP SUM	No Bid	No Bid	No Bid	No Bid	No Bid
Mineral	LUMP SUM	No Bid	No Bid	No Bid	No Bid	No Bid
Mingo	LUMP SUM	No Bid	No Bid	No Bid	No Bid	No Bid
Monongalia	LUMP SUM	No Bid	No Bid	No Bid	No Bid	No Bid
Monroe	LUMP SUM	\$ 1,800.00	\$ 1,000.00	\$ 4,000.00	\$ 3,500.00	\$ 3,500.00
Morgan	LUMP SUM	No Bid	No Bid	No Bid	No Bid	No Bid
Nicholas	LUMP SUM	\$ 1,800.00	\$ 1,000.00	\$ 4,000.00	\$ 3,500.00	\$ 3,500.00
Ohio	LUMP SUM	No Bid	No Bid	No Bid	No Bid	No Bid
Pendleton	LUMP SUM	No Bid	No Bid	No Bid	No Bid	No Bid
Pleasants	LUMP SUM	No Bid	No Bid	No Bid	No Bid	No Bid
Pocahontas	LUMP SUM	\$ 1,800.00	\$ 1,000.00	\$ 4,000.00	\$ 3,500.00	\$ 3,500.00
Preston	LUMP SUM	No Bid	No Bid	No Bid	No Bid	No Bid
Putnam	LUMP SUM	No Bid	No Bid	No Bid	No Bid	No Bid
Raleigh	LUMP SUM	\$ 1,800.00	\$ 1,000.00	\$ 4,000.00	\$ 3,500.00	\$ 3,500.00
Randolph	LUMP SUM	No Bid	No Bid	No Bid	No Bid	No Bid
Ritchie	LUMP SUM	No Bid	No Bid	No Bid	No Bid	No Bid
Roane	LUMP SUM	No Bid	No Bid	No Bid	No Bid	No Bid
Summers	LUMP SUM	\$ 1,800.00	\$ 1,000.00	\$ 4,000.00	\$ 3,500.00	\$ 3,500.00
Taylor	LUMP SUM	No Bid	No Bid	No Bid	No Bid	No Bid
Tucker	LUMP SUM	No Bid	No Bid	No Bid	No Bid	No Bid
Tyler	LUMP SUM	No Bid	No Bid	No Bid	No Bid	No Bid
Upshur	LUMP SUM	No Bid	No Bid	No Bid	No Bid	No Bid
Wayne	LUMP SUM	No Bid	No Bid	No Bid	No Bid	No Bid
Webster	LUMP SUM	No Bid	No Bid	No Bid	No Bid	No Bid
Wetzel	LUMP SUM	No Bid	No Bid	No Bid	No Bid	No Bid
Wirt	LUMP SUM	No Bid	No Bid	No Bid	No Bid	No Bid
Wood	LUMP SUM	No Bid	No Bid	No Bid	No Bid	No Bid
Wyoming	LUMP SUM	No Bid	No Bid	No Bid	No Bid	No Bid

Asphalt Materials Delivery & Labor by Vendor by County
 ATTACHMENT C ASPHALT PLANT LOCATION INFORMATION FORM (ATT C)

Vendor name shall be entered here by the Vendor: Greenbrier Excavating & Paving, Inc

Vendor Instructions: For bidding, Vendor shall enter below the source ASPHALT Plant Names and Locations, including their 911 address. Vendor must list with each source Plant Name and Location listed the counties that plan will be used to service for this contract. Referece Section 7.2.2 for additional instructions. A complete set of pricing pages and plant information forms must be provided for each seperate set of pricing (by county) submitted (ATT A, ATT B, ATT C, ATT D).

Vendor's ASPHALT Plant Location for use with LAYDOWN services:	
This plant shall be sourced by the Vendor to serve the following counties and correspond with counties marked on Pricing Pages:	
County names:	<u>Greenbrier, Monroe, Pocahontas, Summers, Nicholas, Fayette, Raleigh</u>
Plant Name & Location	<u>Greenbrier Excavating & Paving, Inc</u> <u>232 Rambler Road</u> <u>Lewisburg, WV 24901</u>
Vendor's ASPHALT Plant Location for use with LAYDOWN services:	
This plant shall be sourced by the Vendor to serve the following counties and correspond with counties marked on Pricing Pages:	
County names:	
Plant Name & Location	
Vendor's ASPHALT Plant Location for use with LAYDOWN services:	
This plant shall be sourced by the Vendor to serve the following counties and correspond with counties marked on Pricing Pages:	
County names:	
Plant Name & Location	
Vendor's ASPHALT Plant Location for use with LAYDOWN services:	
This plant shall be sourced by the Vendor to serve the following counties and correspond with counties marked on Pricing Pages:	
County names:	
Plant Name & Location	

Asphalt Materials Delivery & Labor by Vendor by County
 ATTACHMENT D STONE PLANT LOCATION INFORMATION FORM (ATT D)

Vendor name shall be entered here by the Vendor: Greenbrier Excavating & Paving, Inc

Vendor Instructions: For bidding, Vendor shall enter below the **STONE** source Plant Names and Locations, including their 911 address. Vendor must list with each source Plant Name and Location listed the counties that plan will be used to service for this contract. Referece Section 7.2.2 for additional instructions. A complete set of Pricing Pages and Plant Information Forms must be provided for each seperate set of pricing (by county) submitted (ATT A, ATT B, ATT C, ATT D).

Vendor's SHOULDER STONE Plant Location for use with LAYDOWN services:	
This plant shall be sourced by the Vendor to serve the following counties and correspond with counties marked on Pricing Pages:	
County names:	Greenbrier, Monroe, Pocahontas, Summers, Nicholas, Fayette, Raleigh
Plant Name & Location	Appalachian Aggregates
	21071 Midland Trail, W
	Lewisburg, WV 24901
Vendor's SHOULDER STONE Plant Location for use with LAYDOWN services:	
This plant shall be sourced by the Vendor to serve the following counties and correspond with counties marked on Pricing Pages:	
County names:	
Plant Name & Location	
Vendor's SHOULDER STONE Plant Location for use with LAYDOWN services:	
This plant shall be sourced by the Vendor to serve the following counties and correspond with counties marked on Pricing Pages:	
County names:	
Plant Name & Location	
Vendor's SHOULDER STONE Plant Location for use with LAYDOWN services:	
This plant shall be sourced by the Vendor to serve the following counties and correspond with counties marked on Pricing Pages:	
County names:	
Plant Name & Location	

STATE OF WEST VIRGINIA
Purchasing Division

PURCHASING AFFIDAVIT

CONSTRUCTION CONTRACTS: Under W. Va. Code § 5-22-1(i), the contracting public entity shall not award a construction contract to any bidder that is known to be in default on any monetary obligation owed to the state or a political subdivision of the state, including, but not limited to, obligations related to payroll taxes, property taxes, sales and use taxes, fire service fees, or other fines or fees.

ALL CONTRACTS: Under W. Va. Code §5A-3-10a, no contract or renewal of any contract may be awarded by the state or any of its political subdivisions to any vendor or prospective vendor when the vendor or prospective vendor or a related party to the vendor or prospective vendor is a debtor and: (1) the debt owed is an amount greater than one thousand dollars in the aggregate; or (2) the debtor is in employer default.

EXCEPTION: The prohibition listed above does not apply where a vendor has contested any tax administered pursuant to chapter eleven of the W. Va. Code, workers' compensation premium, permit fee or environmental fee or assessment and the matter has not become final or where the vendor has entered into a payment plan or agreement and the vendor is not in default of any of the provisions of such plan or agreement.

DEFINITIONS:

"Debt" means any assessment, premium, penalty, fine, tax or other amount of money owed to the state or any of its political subdivisions because of a judgment, fine, permit violation, license assessment, defaulted workers' compensation premium, penalty or other assessment presently delinquent or due and required to be paid to the state or any of its political subdivisions, including any interest or additional penalties accrued thereon.

"Employer default" means having an outstanding balance or liability to the old fund or to the uninsured employers' fund or being in policy default, as defined in W. Va. Code § 23-2c-2, failure to maintain mandatory workers' compensation coverage, or failure to fully meet its obligations as a workers' compensation self-insured employer. An employer is not in employer default if it has entered into a repayment agreement with the Insurance Commissioner and remains in compliance with the obligations under the repayment agreement.

"Related party" means a party, whether an individual, corporation, partnership, association, limited liability company or any other form or business association or other entity whatsoever, related to any vendor by blood, marriage, ownership or contract through which the party has a relationship of ownership or other interest with the vendor so that the party will actually or by effect receive or control a portion of the benefit, profit or other consideration from performance of a vendor contract with the party receiving an amount that meets or exceeds five percent of the total contract amount.

AFFIRMATION: By signing this form, the vendor's authorized signer affirms and acknowledges under penalty of law for false swearing (W. Va. Code §61-5-3) that: (1) for construction contracts, the vendor is not in default on any monetary obligation owed to the state or a political subdivision of the state, and (2) for all other contracts, that neither vendor nor any related party owe a debt as defined above and that neither vendor nor any related party are in employer default as defined above, unless the debt or employer default is permitted under the exception above.

WITNESS THE FOLLOWING SIGNATURE:

Vendor's Name: Greenbrier Excavating & Paving, Inc.

Authorized Signature: [Signature] Date: 2/16/21

State of West Virginia

County of Greenbrier, to-wit:

Taken, subscribed, and sworn to before me this 16 day of February, 2021.

My Commission expires Jan. 06, 2022.

AFFIX SEAL HERE



NOTARY PUBLIC

[Signature]

West Virginia Ethics Commission



Disclosure of Interested Parties to Contracts

Pursuant to *W. Va. Code* § 6D-1-2, a state agency may not enter into a contract, or a series of related contracts, that has/have an actual or estimated value of \$1 million or more until the business entity submits to the contracting state agency a Disclosure of Interested Parties to the applicable contract. In addition, the business entity awarded a contract is obligated to submit a supplemental Disclosure of Interested Parties reflecting any new or differing interested parties to the contract within 30 days following the completion or termination of the applicable contract.

For purposes of complying with these requirements, the following definitions apply:

"Business entity" means any entity recognized by law through which business is conducted, including a sole proprietorship, partnership or corporation, but does not include publicly traded companies listed on a national or international stock exchange.

"Interested party" or *"Interested parties"* means:

- (1) A business entity performing work or service pursuant to, or in furtherance of, the applicable contract, including specifically sub-contractors;
- (2) the person(s) who have an ownership interest equal to or greater than 25% in the business entity performing work or service pursuant to, or in furtherance of, the applicable contract. (This subdivision does not apply to a publicly traded company); and
- (3) the person or business entity, if any, that served as a compensated broker or intermediary to actively facilitate the applicable contract or negotiated the terms of the applicable contract with the state agency. (This subdivision does not apply to persons or business entities performing legal services related to the negotiation or drafting of the applicable contract.)

"State agency" means a board, commission, office, department or other agency in the executive, judicial or legislative branch of state government, including publicly funded institutions of higher education: Provided, that for purposes of *W. Va. Code* § 6D-1-2, the West Virginia Investment Management Board shall not be deemed a state agency nor subject to the requirements of that provision.

The contracting business entity must complete this form and submit it to the contracting state agency prior to contract award and to complete another form within 30 days of contract completion or termination.

This form was created by the State of West Virginia Ethics Commission, 210 Brooks Street, Suite 300, Charleston, WV 25301-1804. Telephone: (304)558-0664; fax: (304)558-2169; e-mail: ethics@wv.gov; website: www.ethics.wv.gov.

West Virginia Ethics Commission
Disclosure of Interested Parties to Contracts

(Required by W. Va. Code § 6D-1-2)

Name of Contracting Business Entity: Greenbrier Excavating & Paving, Inc Address: PO Box 277, Ronceverte, WV 24970

Name of Authorized Agent: William Alan O'Brien Address: PO Box 277, Ronceverte, WV 24970

Contract Number: ARFQ DOT2100000029 Contract Description: Asphalt Material, Delivery & Labor by Vendor by County

Governmental agency awarding contract: West Virginia Division of Highways

Check here if this is a Supplemental Disclosure

List the Names of Interested Parties to the contract which are known or reasonably anticipated by the contracting business entity for each category below (attach additional pages if necessary):

1. Subcontractors or other entities performing work or service under the Contract

Check here if none, otherwise list entity/individual names below.

2. Any person or entity who owns 25% or more of contracting entity (not applicable to publicly traded entities)

Check here if none, otherwise list entity/individual names below.

3. Any person or entity that facilitated, or negotiated the terms of, the applicable contract (excluding legal services related to the negotiation or drafting of the applicable contract)

Check here if none, otherwise list entity/individual names below.

Signature: W. Alan O'Brien Date Signed: 2/16/21

Notary Verification

State of West Virginia, County of Greenbrier:

I, William Alan O'Brien, the authorized agent of the contracting business entity listed above, being duly sworn, acknowledge that the Disclosure herein is being made under oath and under the penalty of perjury.

Taken, sworn to and subscribed before me this 16 day of February, 2021.

Natalie Morgan
Notary Public's Signature

To be completed by State Agency:

Date Received by State Agency: _____
Date submitted to Ethics Commission: _____
Governmental agency submitting Disclosure: _____



INSTRUCTIONS TO VENDORS SUBMITTING BIDS

West Virginia Division of Highways Maintenance Division

1. REVIEW DOCUMENTS THOROUGHLY: The attached documents contain a solicitation for bids. Please read these instructions and all documents attached in their entirety. These instructions provide critical information about requirements that if overlooked could lead to disqualification of a Vendor's bid. All bids must be submitted in accordance with the provisions contained in these instructions and the Solicitation. Failure to do so may result in disqualification of Vendor's bid.

2. MANDATORY TERMS: The Solicitation may contain mandatory provisions identified by the use of the words "must," "will," and "shall." Failure to comply with a mandatory term in the Solicitation will result in bid disqualification.

3. BID SUBMISSION: All bids must be submitted electronically through the West Virginia Vendor Self Service Portal website or signed, sealed in an envelope and delivered by the Vendor to the Agency on or before the date and time of the bid opening. Any bid received by the Agency staff is considered to be in the possession of the Agency and will not be returned for any reason. In the event that a Vendor submits multiple bids in response to the same Solicitation, the bid with the most recent Agency or wvOASIS time stamp shall be the bid considered by the Agency and the Agency shall disregard all other bids by that Vendor for that Solicitation. Any bid received by the Agency after the date and time of the bid opening as specified in the Solicitation shall be disregarded by the Agency.

3A. BID SUBMISSION: A bid that is not submitted electronically through wvOasis should contain the listed information below on the face of the envelope or the bid may be rejected by the Agency.

SEALED BID: 6621C044 – Asphalt Material, Delivery & Labor by Vendor by County

BUYER: TINA LEWIS

SOLICITATION NUMBER: ARFQ DOT2100000029

BID OPENING DATE: 02/28/2021

BID OPENING TIME: 2:30PM

4. ADDENDUM ACKNOWLEDGEMENT: Changes or revisions to this Solicitation will be made by an official addendum issued by the Agency. Vendor should acknowledge receipt of all addenda issued with this Solicitation by completing an Addendum Acknowledgment Form, a copy of which is included herewith. Failure to acknowledge addenda may result in bid disqualification. The addendum acknowledgement should be submitted with the bid to expedite document processing.

5. BID FORMATTING: Vendor should type or electronically enter the information onto its bid to prevent errors in the evaluation. Failure to type or electronically enter the information may result in bid disqualification.

6. ALTERNATES: Any model, brand, or specification listed in this Solicitation establishes the acceptable level of quality only and is not intended to reflect a preference for, or in any way favor, a particular brand or vendor. Vendors may bid alternates to a listed model or brand provided that the alternate is at least equal to the model or brand and complies with the required specifications. The equality of any alternate being bid shall be determined by the Agency at its sole discretion. Any Vendor bidding an alternate model or brand should clearly identify the alternate items in its bid and should include manufacturer's specifications, industry literature, and/or any other relevant documentation demonstrating the equality of the alternate items. Failure to provide information for alternate items may be grounds for rejection of a Vendor's bid.

7. EXCEPTIONS AND CLARIFICATIONS: The Solicitation contains the specifications that shall form the basis of a contractual agreement. Vendor shall clearly mark any exceptions, clarifications, or other proposed modifications in its bid. Exceptions to, clarifications of, or modifications of a requirement or term and condition of the Solicitation may result in bid disqualification.

8. REGISTRATION: Prior to Contract award, the apparent successful Vendor must be properly registered with the West Virginia Purchasing Division and must have paid the \$125 fee, or the fee then assessed by said Division, if applicable.

9. UNIT PRICE: Unit prices shall prevail in cases of a discrepancy in the Vendor's bid.

10. PREFERENCE: Vendor Preference may only be granted upon written request and only in accordance with the West Virginia Code § 5A-3-37 and the West Virginia Code of State Rules. A Vendor Preference Certificate form has been attached hereto to allow Vendor to apply for the preference. Vendor's failure to submit the Vendor Preference Certificate form with its bid will result in denial of Vendor Preference.

11. SMALL, WOMEN-OWNED, OR MINORITY-OWNED BUSINESSES: For any solicitations publicly advertised for bid, in accordance with West Virginia Code §5A-3-37(a)(7) and W. Va. CSR § 148-22-9, any non-resident vendor certified as a small, women-owned, or minority-owned business under W. Va. CSR § 148-22-9 shall be provided the same preference made available to any resident vendor. Any non-resident small, women-owned, or minority-owned business must identify itself as such in writing, must submit that writing to the Purchasing Division with its bid, and must be properly certified under W. Va. CSR § 148-22-9 prior to contract award to receive the preferences made available to resident vendors. Preference for a non-resident small, women-owned, or minority owned business shall be applied in accordance with W. Va. CSR § 148-22-9.

12. ELECTRONIC FILE ACCESS RESTRICTIONS: Vendor must ensure that its submission in the West Virginia Vendor Self Service Portal website can be accessed by the Agency staff immediately upon bid opening. The Agency will consider any file that cannot be immediately opened and/or viewed at the time of the bid opening (such as, encrypted files, password protected files, or incompatible files) to be blank or incomplete as context requires, and therefore

unacceptable. A vendor will not be permitted to unencrypt files, remove password protections, or resubmit documents after bid opening if those documents are required with the bid.

13. NON-RESPONSIBLE: The Agency reserves the right to reject the bid of any vendor when the Agency determines that the vendor submitting the bid does not have the capability to fully perform or lacks the integrity and reliability to assure good-faith performance. A determination of non-responsibility will only extend to the contract for which the vendor has submitted a bid and does not operate as a bar against submitting future bids.

14. ACCEPTANCE/REJECTION: The Agency may accept or reject any bid in whole, or in part when the Agency determines it is in the best interest of the State.

15. TIE BIDS: When tie bids are received and the Agency intends to award the work to only one vendor, the Agency shall break the tie by allowing the tied vendors to make a final offer, flip of a coin, draw of the cards, or any other impartial method considered prudent by the Agency. If tie bids are received and the Agency intends to award the bid to multiple vendors, the Agency may award the bid to the number of the tied bidders as Agency deems necessary using the procedure set forth in this section to establish the number of tied bidders which will be awarded the bid.

16. YOUR SUBMISSION IS A PUBLIC DOCUMENT: Vendor's entire response to the Solicitation and the resulting Contract are public documents. As public documents, they will be disclosed to the public following the bid/proposal opening or award of the contract, as required by the competitive bidding laws of West Virginia Code §§ 5A-3-1 et seq., 5-22-1 et seq., 5G-1-1 et seq. and the Freedom of Information Act in West Virginia Code §§ 29B-1-1 et seq. Submission of any bid, proposal, or other document to the Agency constitutes your explicit consent to the subsequent public disclosure of the bid, proposal, or document. Labeling any document "confidential," "proprietary," "trade secret," "private," or labeled with any other claim against public disclosure of the documents will not protect that document from public disclosure. All submissions are subject to public disclosure without notice.

DO NOT SUBMIT MATERIAL YOU CONSIDER TO BE CONFIDENTIAL, A TRADE SECRET, OR OTHERWISE NOT SUBJECT TO PUBLIC DISCLOSURE.

GENERAL TERMS AND CONDITIONS:

1. CONTRACTUAL AGREEMENT: Issuance of an Award Document signed by the Agency and approved as to form by legal counsel for the Agency, if required, constitutes acceptance of this Contract made by and between the Agency and the Vendor. Vendor's signature on its bid signifies Vendor's agreement to be bound by and accept the terms and conditions contained in this Contract.

2. DEFINITIONS: As used in this Solicitation/Contract, the following terms shall have the meanings attributed to them below. Additional definitions may be found in the specifications included with this Solicitation/Contract.

2.1. "Agency" means the West Virginia Department of Transportation, Division of Highways. This Contract is entered into by the Agency pursuant to the provisions of West Virginia Code § 17-4-19 and §17-2A-8.

2.2. "Bid" or "Proposal" means the vendors submitted response to this solicitation.

2.3. "Contract" means the binding agreement that is entered into between the Agency and the Vendor to provide the goods or services requested in the Solicitation. The Contract shall be comprised of the (i) Solicitation and any other document required by the Solicitation (ii) Bid or Proposal (iii) Award Document and (iv) General Terms and Conditions; Instruction to Vendors Submitting Bids, collectively referred to as the "Contract Documents".

2.4. "Award Document" means the document signed by the Agency and approved as to form by legal counsel for the agency, that identifies the Vendor as the contract holder.

2.5. "Solicitation" means the official notice of an opportunity to supply the Agency with goods or services.

2.6. "State" means the State of West Virginia and/or any of its agencies, commissions, boards, etc. as context requires.

2.7. "Vendor" or "Vendors" means any entity submitting a bid in response to the Solicitation, the entity that has been selected as the lowest responsible bidder, or the entity that has been awarded the Contract as context requires.

3. CONTRACT TERM; RENEWAL; EXTENSION: The term of this Contract shall be determined in accordance with the category that has been identified as applicable to this Contract below:

Term Contract

Initial Contract Term: This Contract becomes effective on award _____ and extends for a period of one _____ year(s).

Renewal Term: This Contract may be renewed upon the mutual written consent of the Agency, and the Vendor. Any request for renewal should be submitted in writing to the Agency thirty (30) days prior to the expiration date of the initial contract term or appropriate renewal term. A Contract renewal shall be in accordance with the terms and conditions of the original contract. Renewal of this Contract is limited to three (3) successive one (1) year periods or multiple renewal periods of less than one year, provided that the multiple renewal periods do not exceed 36 months in total. Automatic renewal of this Contract is prohibited.

Delivery Order Limitations: In the event that this contract permits delivery orders, a delivery order may only be issued during the time this Contract is in effect. Any delivery order issued prior to the expiration of this Contract shall be effective for no more than one year from the date the delivery order is issued. No delivery order may be extended beyond one year after this Contract has expired.

Fixed Period Contract: This Contract becomes effective upon Vendor's receipt of the notice to proceed and must be completed within _____ days.

Fixed Period Contract with Renewals: This Contract becomes effective upon Vendor's receipt of the notice to proceed and that part of the Contract more fully described in the attached specifications must be completed within _____ days. Upon completion, the vendor agrees that maintenance, monitoring, or warranty services will be provided for _____ successive one-year periods or multiple periods of less than one year provided that the multiple renewal periods do not exceed _____ months in total.

One Time Purchase: The term of this Contract shall run from the issuance of the Award Document until all goods contracted for have been delivered, but in no event will this Contract extend for more than one calendar year.

Other: See attached.

4. NOTICE TO PROCEED: Vendor shall begin performance of this Contract immediately upon receiving notice to proceed unless otherwise instructed by the Agency. Unless otherwise specified, the fully executed Award Document will be considered notice to proceed.

5. QUANTITIES: The quantities required under this Contract shall be determined in accordance with the category that has been identified as applicable to this Contract below.

Open End Contract: Quantities listed in this Solicitation are approximations only, based on estimates supplied by the Agency. It is understood and agreed that the Contract shall cover the quantities actually ordered for delivery during the term of the Contract, whether more or less than the quantities shown.

Service: The scope of the service to be provided will be more clearly defined in the specifications included herewith.

Combined Service and Goods: The scope of the service and deliverable goods to be provided will be more clearly defined in the specifications included herewith.

One Time Purchase: This Contract is for the purchase of a set quantity of goods that are identified in the specifications included herewith. Once those items have been delivered, no additional goods may be procured under this Contract without an appropriate change order approved by the Vendor and Agency.

6. PRICING: The pricing set forth herein is firm for the life of the Contract, unless specified elsewhere within this Solicitation/Contract by the Agency. A Vendor's inclusion of price adjustment provisions in its bid, without an express authorization from the Agency in the Solicitation to do so, may result in bid disqualification.

7. EMERGENCY PURCHASES: The Agency may purchase goods or services in the open market that Vendor would otherwise provide under this Contract if those goods or services are for immediate or expedited delivery in an emergency and Vendor is unable to provide those goods and services on an immediate or expedited basis in the sole judgment of Agency. Emergencies shall include, but are not limited to, delays in transportation or an unanticipated increase in the volume of work. An emergency purchase in the open market, by the Agency, shall not constitute a breach of this Contract and shall not entitle the Vendor to injunctive relief or to any form of compensation or damages. This provision does not excuse the State from fulfilling its obligations under a One Time Purchase contract.

8. REQUIRED DOCUMENTS: All items checked below must be provided to the Agency by the Vendor as specified below.

BID BOND: All Vendors shall furnish a bid bond in the amount of five percent (5%) of the total amount of the bid protecting the State of West Virginia. The bid bond must be submitted with the bid.

PERFORMANCE BOND: The apparent successful Vendor shall provide a performance bond in the amount of _____. The performance bond must be received by the Agency prior to Contract award.

LABOR/MATERIAL PAYMENT BOND: The apparent successful Vendor shall provide a labor/material payment bond in the amount of 100% of the Contract value. The labor/material payment bond must be delivered to the Agency prior to Contract award.

In lieu of the Bid Bond, Performance Bond, and Labor/Material Payment Bond, the Vendor may provide certified checks, cashier's checks, or irrevocable letters of credit. Any certified check, cashier's check, or irrevocable letter of credit provided in lieu of a bond must be of the same amount and delivered on the same schedule as the bond it replaces. A letter of credit submitted in lieu of a performance and labor/material payment bond will only be allowed for projects under \$100,000. Personal or business checks are not acceptable.

MAINTENANCE BOND: The apparent successful Vendor shall provide a two (2) year maintenance bond covering the roofing system. The maintenance bond must be issued and delivered to the Agency prior to Contract award.

INSURANCE: The apparent successful Vendor shall furnish proof of the following insurance prior to Contract award and shall list the State as a certificate holder:

Commercial General Liability Insurance: In the amount of \$1,000,000.00 _____ or more.

Builders Risk Insurance: In an amount equal to 100% of the amount of the Contract.

-
-
-
-
-

The apparent successful Vendor shall also furnish proof of any additional insurance requirements contained in the specifications prior to Contract award regardless of whether or not that insurance requirement is listed above.

LICENSE(S) / CERTIFICATIONS / PERMITS: In addition to anything required under the Section entitled Licensing, of the General Terms and Conditions, the apparent successful Vendor shall furnish proof of the following licenses, certifications, and/or permits prior to Contract award, award, in a form acceptable to the Agency.

WEST VIRGINIA CONTRACTOR'S LICENSE

-
-
-
-

The apparent successful Vendor shall also furnish proof of any additional licenses or certifications contained in the specifications prior to Contract award regardless of whether or not that requirement is listed above.

9. WORKERS' COMPENSATION INSURANCE: The apparent successful Vendor shall comply with laws relating to worker's compensation, shall maintain worker's compensation insurance when required, and shall furnish proof of workers' compensation insurance upon request.

10. LIQUIDATED DAMAGES: Vendor shall pay liquidated damages in the amount of _____ for _____. This clause shall in no way be considered exclusive and shall not limit the State or Agency's right to pursue any other available remedy.

11. ACCEPTANCE: Vendor's signature on its bid, or on the certification and signature page, constitutes an offer to the Agency that cannot be unilaterally withdrawn, signifies that the product or service proposed by vendor meets the mandatory requirements contained in the Solicitation for that product or service, unless otherwise indicated, and signifies acceptance of the terms and conditions contained in the Solicitation unless otherwise indicated.

12. FUNDING: This Contract shall continue for the term stated herein, contingent upon funds being appropriated by the Legislature or otherwise being made available. In the event funds are not appropriated or otherwise made available, this Contract becomes void and of no effect beginning on July 1 of the fiscal year for which funding has not been appropriated or otherwise made available.

13. PAYMENT: Payment in advance is prohibited under this Contract. Payment may only be made after the delivery and acceptance of goods or services. The Vendor shall submit invoices in arrears.

14. TAXES: The Vendor shall pay any applicable sales, use, personal property or any other taxes arising out of this Contract and the transactions contemplated thereby. The State of West Virginia is exempt from federal and state taxes and will not pay or reimburse such taxes.

15. CANCELLATION: The Agency reserves the right to cancel this Contract immediately upon written notice to the vendor if the materials or workmanship supplied do not conform to the specifications contained in the Contract. The Agency may also cancel any purchase or this contract for any reason or no reason upon 30 days written notice to the Vendor.

16. TIME: Time is of the essence with regard to all matters of time and performance in this Contract.

17. APPLICABLE LAW: This Contract is governed by and interpreted under West Virginia law without giving effect to its choice of law principles. Any information provided in specification manuals, or any other source, verbal or written, which contradicts or violates the West Virginia Constitution, West Virginia Code or West Virginia Code of State Rules is void and of no effect.

18. COMPLIANCE: Vendor shall comply with all applicable federal, state, and local laws, regulations and ordinances. By submitting a bid, Vendor acknowledges that it has reviewed, understands, and will comply with all applicable laws, regulations, and ordinances.

19. PREVAILING WAGE: To the extent required by applicable law, Vendor shall be responsible for ensuring compliance with prevailing wage requirements and determining when prevailing wage requirements are applicable.

20. ARBITRATION: Any references made to arbitration contained in this Contract, Vendor's bid, or in any American Institute of Architects documents pertaining to this Contract are hereby deleted, void, and of no effect.

21. MODIFICATIONS: This writing is the parties' final expression of intent. Notwithstanding anything contained in this Contract to the contrary, no modification of this Contract shall be binding without mutual written consent of the Agency and the Vendor.

22. WAIVER: The failure of either party to insist upon a strict performance of any of the terms or provision of this Contract, or to exercise any option, right, or remedy herein contained, shall not be construed as a waiver or a relinquishment for the future of such term, provision, option, right, or

remedy, but the same shall continue in full force and effect. Any waiver must be expressly stated in writing and signed by the waiving party.

23. SUBSEQUENT FORMS: The terms and conditions contained in this Contract shall supersede any and all subsequent terms and conditions which may appear on any form documents submitted by Vendor to the Agency such as price lists, order forms, invoices, sales agreements, or maintenance agreements, and includes internet websites or other electronic documents. Acceptance or use of Vendor's forms does not constitute acceptance of the terms and conditions contained thereon.

24. ASSIGNMENT: Neither this Contract nor any monies due, or to become due hereunder, may be assigned by the Vendor without the express written consent of the Agency and any other government agency or office that may be required to approve such assignments.

25. WARRANTY: The Vendor expressly warrants that the goods and/or services covered by this Contract will: (a) conform to the specifications, drawings, samples, or other description furnished or specified by the Agency; (b) be merchantable and fit for the purpose intended; and (c) be free from defect in material and workmanship.

26. STATE EMPLOYEES: State employees are not permitted to utilize this Contract for personal use and the Vendor is prohibited from permitting or facilitating the same.

27. BANKRUPTCY: In the event the Vendor files for bankruptcy protection, the Agency may deem this Contract null and void, and terminate this Contract without notice.

28. PRIVACY, SECURITY, AND CONFIDENTIALITY: The Vendor agrees that it will not disclose to anyone, directly or indirectly, any personally identifiable information or other confidential information gained from the Agency, unless the individual who is the subject of the information consents to the disclosure in writing or the disclosure is made pursuant to the Agency's policies, procedures, and rules. Vendor further agrees to comply with the Confidentiality Policies and Information Security Accountability Requirements, set forth in:

<http://www.transportation.wv.gov/Documents/WVDOT-Privacy-Notice.pdf>.

29. YOUR SUBMISSION IS A PUBLIC DOCUMENT: Vendor's entire response to the Solicitation and the resulting Contract are public documents. As public documents, they will be disclosed to the public following the bid/proposal opening or award of the contract, as required by the competitive bidding laws of West Virginia Code §§ 5A-3-1 et seq., 5-22-1 et seq., and 5G-1-1 et seq. and the Freedom of Information Act West Virginia Code §§ 29B-1-1 et seq. Submission of any bid, proposal, or other document to the Agency constitutes your explicit consent to the subsequent public disclosure of the bid, proposal, or document. Labeling any document labeled "confidential," "proprietary," "trade secret," "private," or labeled with any other claim against public disclosure of the documents will not protect that document from public disclosure. All submissions are subject to public disclosure without notice.

DO NOT SUBMIT MATERIAL YOU CONSIDER TO BE CONFIDENTIAL, A TRADE SECRET, OR OTHERWISE NOT SUBJECT TO PUBLIC DISCLOSURE.

30. LICENSING: Vendor must be licensed and in good standing in accordance with any and all state and local laws and requirements by any state or local agency of West Virginia, including, but not limited to, the West Virginia Secretary of State's Office, the West Virginia Tax Department, West Virginia Insurance Commission, or any other state agency or political subdivision. Upon request, the Vendor must provide all necessary releases to obtain information to enable the Agency to verify that the Vendor is licensed and in good standing with the above entities.

31. ANTITRUST: In submitting a bid to, signing a contract with, or accepting an Award Document from Agency, the Vendor agrees to convey, sell, assign, or transfer to the State of West Virginia all rights, title, and interest in and to all causes of action it may now or hereafter acquire under the antitrust laws of the United States and the State of West Virginia for price fixing and/or unreasonable restraints of trade relating to the particular commodities or services purchased or acquired by the State of West Virginia. Such assignment shall be made and become effective at the time the purchasing agency tenders the initial payment to Vendor.

32. VENDOR CERTIFICATIONS: By signing its bid or entering into this Contract, Vendor certifies (1) that its bid or offer was made without prior understanding, agreement, or connection with any corporation, firm, limited liability company, partnership, person or entity submitting a bid or offer for the same material, supplies, equipment or services; (2) that its bid or offer is in all respects fair and without collusion or fraud; (3) that this Contract is accepted or entered into without any prior understanding, agreement, or connection to any other entity that could be considered a violation of law; and (4) that it has reviewed this Solicitation in its entirety; understands the requirements, terms and conditions, and other information contained herein. Vendor's signature on its bid or offer also affirms that neither it nor its representatives have any interest, nor shall acquire any interest, direct or indirect, which would compromise the performance of its services hereunder. Any such interests shall be promptly presented in detail to the Agency. The individual signing this bid or offer on behalf of Vendor certifies that he or she is authorized by the Vendor to execute this bid or offer or any documents related thereto on Vendor's behalf; that he or she is authorized to bind the Vendor in a contractual relationship; and that, to the best of his or her knowledge, the Vendor has properly registered with any State agency that may require registration.

33. PURCHASING CARD ACCEPTANCE: The State of West Virginia currently utilizes an Electronic Funds Transfer (EFT) as well as a Purchasing Card program, administered under contract by a banking institution, to process payment for goods and services. The Vendor must accept the State of West Virginia's Purchasing Card for payment of all orders under this Contract unless the box below is checked.

Vendor is not required to accept the State of West Virginia's Purchasing Card as payment for all goods and services.

34. VENDOR RELATIONSHIP: The relationship of the Vendor to the State shall be that of an independent contractor and no principal-agent relationship or employer-employee relationship is contemplated or created by this Contract. The Vendor as an independent contractor is solely liable for the acts and omissions of its employees and agents. Vendor shall be responsible for selecting, supervising, and compensating any and all individuals employed pursuant to the terms of this Solicitation and resulting contract. Neither the Vendor, nor any employees or subcontractors of the

Vendor, shall be deemed to be employees of the State for any purpose whatsoever. Vendor shall be exclusively responsible for payment of employees and contractors for all wages and salaries, taxes, withholding payments, penalties, fees, fringe benefits, professional liability insurance premiums, contributions to insurance and pension, or other deferred compensation plans, including but not limited to, Workers' Compensation and Social Security obligations, licensing fees, etc. and the filing of all necessary documents, forms, and returns pertinent to all of the foregoing. Vendor shall hold harmless the State and shall provide the State and Agency with a defense against any and all claims including, but not limited to, the foregoing payments, withholdings, contributions, taxes, Social Security taxes, and employer income tax returns.

35. INDEMNIFICATION: To the fullest extent permitted by law, the Vendor agrees to defend, indemnify, and hold harmless the Agency, its officers, agents and employees from and against all suits, claims, damages, liability, losses, and expenses, including but not limited to attorney's fees and costs of investigations, arising out of, pertaining to or resulting from the performance of work for the above identified Project, including all claims, damages, losses or expenses which are attributable to bodily injury, sickness, disease or death, or to damage to or destruction of property, whether caused either wholly or in part by the negligence, actions or omissions of the Vendor, a Subcontractor or anyone directly or indirectly employed by the Vendor or Subcontractor or for anyone whose acts the Vendor or Subcontractor may be liable, except for any liability or damages due to the willful or intentional unlawful acts or the sole negligence of the Agency or its employees.

36. PURCHASING AFFIDAVIT: In accordance with West Virginia Code § 5A-3-10a, all Vendors are required to sign, notarize, and submit the Purchasing Affidavit stating that neither the Vendor nor a related party owe a debt to the State in excess of \$1,000. The affidavit must be submitted prior to the award, but should be submitted with the Vendor's bid. A copy of the Purchasing Affidavit is included herewith.

37. CONFLICT OF INTEREST: Vendor, its officers or members or employees, shall not presently have or acquire an interest, direct or indirect, which would conflict with or compromise the performance of its obligations hereunder. Vendor shall periodically inquire of its officers, members and employees to ensure that a conflict of interest does not arise. Any conflict of interest discovered shall be promptly presented in detail to the Agency.

38. REPORTS: Vendor shall provide the Agency with the following reports identified by a checked box below:

Such reports as the Agency may request. Requested reports may include, but are not limited to, quantities purchased, agencies utilizing the contract, total contract expenditures by agency, etc.

Quarterly reports detailing the total quantity of purchases in units and dollars, along with a listing of purchases by agency. Quarterly reports should be delivered to the Agency via email to the Agency representative specified by Agency.

39. BACKGROUND CHECK: In accordance with W. Va. Code § 15-2D-3, the Director of the Division of Protective Services shall require any service provider whose employees are regularly

employed on the grounds or in the buildings of the Capitol complex or who have access to sensitive or critical information to submit to a fingerprint-based state and federal background inquiry through the state repository. The service provider is responsible for any costs associated with the fingerprint-based state and federal background inquiry. After the contract for such services has been approved, but before any such employees are permitted to be on the grounds or in the buildings of the Capitol complex or have access to sensitive or critical information, the service provider shall submit a list of all persons who will be physically present and working at the Capitol complex to the Director of the Division of Protective Services for purposes of verifying compliance with this provision. The State reserves the right to prohibit a service provider's employees from accessing sensitive or critical information or to be present at the Capitol complex based upon results addressed from a criminal background check. Service providers should contact the West Virginia Division of Protective Services by phone at (304) 558-9911 for more information.

40. PREFERENCE FOR USE OF DOMESTIC STEEL PRODUCTS: Except when authorized by the Director of the Purchasing Division pursuant to W. Va. Code § 5A-3-56, no contractor may use or supply steel products for a State Contract Project other than those steel products made in the United States. A contractor who uses steel products in violation of this section may be subject to civil penalties pursuant to W. Va. Code § 5A-3-56. As used in this section:

- a. "State Contract Project" means any erection or construction of, or any addition to, alteration of or other improvement to any building or structure, including, but not limited to, roads or highways, or the installation of any heating or cooling or ventilating plants or other equipment, or the supply of and materials for such projects, pursuant to a contract with the State of West Virginia for which bids were solicited on or after June 6, 2001.
- b. "Steel Products" means products rolled, formed, shaped, drawn, extruded, forged, cast, fabricated or otherwise similarly processed, or processed by a combination of two or more or such operations, from steel made by the open hearth, basic oxygen, electric furnace, Bessemer or other steel making process. The Purchasing Division Director may, in writing, authorize the use of foreign steel products if:
- c. The cost for each contract item used does not exceed one tenth of one percent (.1%) of the total contract cost or two thousand five hundred dollars (\$2,500.00), whichever is greater. For the purposes of this section, the cost is the value of the steel product as delivered to the project; or
- d. The Director of the Purchasing Division determines that specified steel materials are not produced in the United States in sufficient quantity or otherwise are not reasonably available to meet contract requirements.

41. PREFERENCE FOR USE OF DOMESTIC ALUMINUM, GLASS, AND STEEL: In Accordance with W. Va. Code § 5-19-1 et seq., and W. Va. CSR § 148-10-1 et seq., for every contract or subcontract, subject to the limitations contained herein, for the construction, reconstruction, alteration, repair, improvement or maintenance of public works or for the purchase of any item of machinery or equipment to be used at sites of public works, only domestic aluminum, glass or steel products shall be supplied unless the spending officer determines, in writing, after the receipt of offers or bids, (1) that the cost of domestic aluminum, glass or steel products is unreasonable or inconsistent with the public interest of the State of West Virginia, (2)

that domestic aluminum, glass or steel products are not produced in sufficient quantities to meet the contract requirements, or (3) the available domestic aluminum, glass, or steel do not meet the contract specifications. This provision only applies to public works contracts awarded in an amount more than fifty thousand dollars (\$50,000) or public works contracts that require more than ten thousand pounds of steel products.

The cost of domestic aluminum, glass, or steel products may be unreasonable if the cost is more than twenty percent (20%) of the bid or offered price for foreign made aluminum, glass, or steel products. If the domestic aluminum, glass or steel products to be supplied or produced in a "substantial labor surplus area", as defined by the United States Department of Labor, the cost of domestic aluminum, glass, or steel products may be unreasonable if the cost is more than thirty percent (30%) of the bid or offered price for foreign made aluminum, glass, or steel products. This preference shall be applied to an item of machinery or equipment, as indicated above, when the item is a single unit of equipment or machinery manufactured primarily of aluminum, glass or steel, is part of a public works contract and has the sole purpose or of being a permanent part of a single public works project. This provision does not apply to equipment or machinery purchased by a spending unit for use by that spending unit and not as part of a single public works project.

All bids and offers including domestic aluminum, glass or steel products that exceed bid or offer prices including foreign aluminum, glass or steel products after application of the preferences provided in this provision may be reduced to a price equal to or lower than the lowest bid or offer price for foreign aluminum, glass or steel products plus the applicable preference. If the reduced bid or offer prices are made in writing and supersede the prior bid or offer prices, all bids or offers, including the reduced bid or offer prices, will be reevaluated in accordance with this rule.

42. It is hereby expressly covenanted, agreed and understood by and between the parties hereto, that the Vendor will immediately make payment and refund to the Agency for any and all overpayments made by said Agency to the Vendor on any estimate or estimates, advances ,if applicable ,or partial payments made on this Contract. Agency is given the right and authority to withhold any and all funds in its possession, belonging to, owed by, or which may be owed by it to the Vendor on any agreement or from any other source for the recovery of any overpayment made in connection with this contract. It is further expressly agreed that the statute of limitations will not commence to run against the Agency for such overpayments until the same is discovered and made known to the Agency.

43. In the event of conflicts or discrepancies among the Contract Documents, interpretations will be based on the following priorities in the order listed below with the highest priority being subsection a:

- a. General Terms and Conditions; Instructions to Vendors Submitting Bids,
- b. Solicitation and any documents required by the Solicitation,
- c. Bid or Proposal,
- d. Award Document.

CERTIFICATION AND SIGNATURE PAGE

By signing below, or submitting documentation through the West Virginia Vendor Self Service Portal website, I certify that I have reviewed this Solicitation in its entirety; that I understand the requirements, terms and conditions, and other information contained herein; that this bid, offer or proposal constitutes an offer to the State that cannot be unilaterally withdrawn; that the product or service proposed meets the mandatory requirements contained in the Solicitation for that product or service, unless otherwise stated herein; that the Vendor accepts the terms and conditions contained in the Solicitation, unless otherwise stated herein; that I am submitting this bid, offer or proposal for review and consideration; that I am authorized by the vendor to execute and submit this bid, offer, or proposal, or any documents related thereto on vendor's behalf; that I am authorized to bind the vendor in a contractual relationship; and that to the best of my knowledge, the vendor has properly registered with any State agency that may require registration.

Greenbrier Excavating & Paving, Inc.
(Full Company Name)

(Authorized Signature)

William A. O'Brien / VP
(Print or Type Name and Title of Signatory)

304-647-4296
(Phone Number)

304-645-4610
(Fax Number)

gep@wvds1.net
(Email address)

2/16/2021
(Date)

**Form pre-approved by DOH legal division on July 12, 2016.
Attorney signature not required.**

ADDENDUM ACKNOWLEDGEMENT FORM
SOLICITATION NO.: ARFQ DOT210000029

Instructions: Please acknowledge receipt of all addenda issued with this solicitation by completing this addendum acknowledgment form. Check the box next to each addendum received and sign below. Failure to acknowledge addenda may result in bid disqualification.

Acknowledgment: I hereby acknowledge receipt of the following addenda and have made the necessary revisions to my proposal, plans and/or specification, etc.

Addendum Numbers Received:
(Check the box next to each addendum received)

- | | |
|--|--|
| <input checked="" type="checkbox"/> Addendum No. 1 | <input type="checkbox"/> Addendum No. 6 |
| <input type="checkbox"/> Addendum No. 2 | <input type="checkbox"/> Addendum No. 7 |
| <input type="checkbox"/> Addendum No. 3 | <input type="checkbox"/> Addendum No. 8 |
| <input type="checkbox"/> Addendum No. 4 | <input type="checkbox"/> Addendum No. 9 |
| <input type="checkbox"/> Addendum No. 5 | <input type="checkbox"/> Addendum No. 10 |

I understand that failure to confirm the receipt of addenda may be cause for rejection of this bid. I further understand that any verbal representation made or assumed to be made during any oral discussion held between Vendor's representatives and any state personnel is not binding. Only the information issued in writing and added to the specifications by an official addendum is binding.

Greenbrier Excavating & Paving, Inc.

Full Company Name



Authorized Signature

2/16/21

Date

NOTE: This addendum acknowledgment should be submitted with the bid to expedite document processing.

AGENCY SOLICITATION NUMBER-ARFQ DOT2100000029
Addendum Number: 1

The Purpose of this addendum is to modify the solicitation identified as ("Agency Solicitation") to reflect the change(s) identified and described below.

Applicable Addendum Category:

- Modify bid opening date and time
- Modify specification of product or service being sought
- Attachment of pre-bid sign-in sheet
- Attachment of vendor questions and responses
- Correction of error
- Other

Description of Modification to Solicitation:

To correct the bid opening date on the instructions to vendors form:

Date: 02/18/2021 Time: 2:30PM

Additional Documentation: Documentation related to this Addendum (if any) has been included herewith as Attachment A and is specifically incorporated herein by reference.

Terms and Conditions:

1. All provision of the Agency Solicitation and other addenda not modified herein shall remain in full force and effect.
2. Vendor should acknowledge receipt of all addenda issued for this Agency Solicitation by completing an Addendum Acknowledgement, a copy of which is included herewith. Failure to acknowledge addenda may result in bid disqualification. The addendum acknowledgement should be submitted with the bid to expedite document processing.

ATTACHMENT A

REQUEST FOR QUOTATION
Asphalt Materials, Delivery & Labor by Vendor by County

SPECIFICATIONS

1. **PURPOSE AND SCOPE:** The West Virginia Division of Highways is soliciting bids to establish an open-end Asphalt contract for use on preventive maintenance and repair projects throughout the state of West Virginia including materials, delivery and labor, by the Vendor, to WVDOH and West Virginia Parkways Authority project sites.

2. **DEFINITIONS:** The terms listed below shall have the following meanings assigned to them throughout and for the purpose of this Solicitation. Additional definitions can be found in Section 2 of the General Terms and Conditions.
 - 2.1 **“Contract Item” “Contract Item(s)”** - Contract Items are identified in Section 3 of this Solicitation.

 - 2.2 **“Pricing Pages”** - The schedule of prices attached hereto as **Attachment A Pricing Pages (ATT A)** and **Attachment B Mobilization Pricing Pages (ATT B)** which are used to evaluate the Solicitation responses. There are TWO (2) sets of Pricing Pages.

NOTE: Vendor’s Pricing Pages shall accompany and correspond with Vendor’s Plant Information forms.

 - 2.3 **“Solicitation”** - The official notice of an opportunity to supply the State with goods and/or services that is published by the West Virginia Division of Highways.

 - 2.4 **“WVDOH”** - West Virginia Division of Highways.

 - 2.5 **“MP”** - Material Procedures, as amended, issued by the WVDOH Materials Control, Soils and Testing Division. The MP numbers references throughout these Contract Specifications are available by MP number at:
<https://transportation.wv.gov/highways/mcst/Pages/WVDOH-Materials-Procedures.aspx>

 - 2.6 **“MCS&T”** - The WVDOH Materials Control, Soil and Testing Division, who perform all procedures necessary with sampling, testing, reporting and inspection of products and materials to maintain a reliable quality assurance system. Reference: <http://www.transportation.wv.gov/highways/mcst/Pages/default.aspx>

 - 2.7 **“Emergency Work”** - Work that is required to be done without delay owing to circumstances for which the WVDOH could not have reasonably expected and has been designated as such by, at a minimum, a WVDOH District Engineer or their designee.

REQUEST FOR QUOTATION
Asphalt Materials, Delivery & Labor by Vendor by County

- 2.8 **Asphalt**”, **“Hot Mix Asphalt”** and **“HMA”** - Terms used interchangeably for asphalt.
- 2.9 **“Approved Source,” “Approved Plant,” “Approved Product,” or “Approved Vendor”** - Terms which refers to the Approved Product Lists (APL) of certified manufacturers and/or products that meet acceptable levels of quality as determined by WVDOH Materials Control, Soils and Testing Division (MCS&T). These lists are updated periodically, and it is the Vendors responsibility to refer to the MCS&T website to ensure compliance.
https://transportation.wv.gov/highways/mcst/Pages/APL_By_Number.aspx.
- 2.10 **“PG”** – Performance Grade.
- 2.11 **“RAP”** - Reclaimed Asphalt Pavement.
- 2.12 **“HPTO”** - High Performance Thin Overlay.
- 2.13 **“SP”** - WVDOH Special Provision.
- 2.14 **“Contractor”** or **“Vendor”** - An enterprise that contributes goods or services. Contractor or Vendor used in this Solicitation and in the Standard Specs are interchangeable.
- 2.15 **“Standard Specs”** - The West Virginia Department of Transportation, Division of Highways Standard Specifications, Roads and Bridges, adopted latest edition, and as amended or modified by all subsequent Supplemental Specifications.
- 2.16 **“Plant Information Form”** and **“Information Form”** - **Mandatory forms which the Vendor must complete and submit with their bid** to identify each of the Vendor’s sourced Plants. Vendor shall provide Plant name, location, and counties served for each Plant sourced for asphalt and/or stone Materials associated with this contract’s Pricing Pages. Plant Information forms are mandatory and must accompany their respective Pricing Pages and be submitted at the time of bid. **This Solicitation requires the TWO (2) Plant Information Forms: Attachment C Asphalt Plant Information Form (ATT C) and Attachment D Stone Plant Information Form (ATT D).**
- 2.17 **“F.O.B”** - Freight on Board Vendors Plant Location.

REQUEST FOR QUOTATION
Asphalt Materials, Delivery & Labor by Vendor by County

3. GENERAL REQUIREMENTS:

- 3.1 Specifications:** The following Standard Specs Sections shall apply to the administration of this contract: 101, 102, 103, 104, 105, 106, 107, 108, 109, 110, as amended.

Materials, equipment, and performance of this contract shall conform, but is not be limited to, the requirements of Sections 307, 401, 408, 415, and 636, as amended.

A hard copy of the current Standard Specs may be purchased at a cost of \$20.00 (\$15.00 for the 2017 book plus \$5.00 for the Supplemental Latest Edition) using the **Attachment E Standard Specifications Order Form (ATT E)**. The completed form should be submitted by email to DOTSpecifications@wv.gov or mailed to:

West Virginia Division of Highways
Contract Administration
Building 5, Room 840
1900 Kanawha Boulevard, East
Charleston, West Virginia 25305

A free electronic copy of the Standard Specs may be obtained by sourcing:
<http://transportation.wv.gov/highways/contractadmin/specifications/Pages/default.aspx>

- 3.2 Contract Items and Mandatory Requirements:** Vendor shall provide Agency with the Contract Items listed below on an open-end and continuing basis. Contract Items must meet or exceed the mandatory requirements as shown below.

3.2.1 Materials:

Contract Item A is considered Materials. Materials from this contract SHALL ONLY be purchased when delivery by the Vendor and Labor by the Vendor are required on a Delivery Order. All materials used on this contract shall be from WVDOH Approved Source/Plant, as amended.

All labor, equipment, and material to complete **Item B “Shoulder Stone Placement for Asphalt 307-Class 10”** shall be included in the unit bid price. Any traffic control required shall be charged per Section 3.2.22 of these Contract Specifications.

3.2.2 Shoulder Stone:

3.2.2.1 Shoulder Stone Placement, Section 307, Class 10, Contract Item B, shall meet the requirements of the Standard Detail for

REQUEST FOR QUOTATION
Asphalt Materials, Delivery & Labor by Vendor by County

Exhibit 1 Shoulder Reconstruction (EXH 1) and Exhibit 2 Restoring Shoulders for Guardrail (EXH 2), or as directed by the Delivery Order and the WVDOH District Engineer or their designee and shall be bid per ton. **Shoulder Stone Placement and Stone will be paid as Contract Item B.**

3.2.2.2 Haul by Vendor – Stone, Contract Item D, is the distance over suitable routes selected by the WVDOH District Engineer or their designee using the allowed for haul costs that will provide the lowest total cost to the WVDOH and shall be measured from the Vendor's Stone plant location, which shall be identified by the Vendor on **Attachment D Stone Plant Information Form (ATT D)**, to the WVDOH's mid-point of the project.

The WVDOH shall source the WV Straight Line Diagrams for WV Primary Routes and WV Secondary Routes for these routes. The Diagrams are available in each WVDOH District Office and the WVDOH Central Office. WVDOH will determine the route to be taken due to bridge and/or road restrictions which shall have acceptable load limits for both roads and bridges. Hauling of Shoulder Stone will be paid as **Contract Item D.**

3.2.2.3 Shoulder Stone Mobilization, Contract Item C, is to compensate Vendor for Mobilization of Shoulder Stone for Placement and shall be priced on **Attachment B Mobilization Pricing Pages (ATT B)** which shall correspond with Vendor's **Attachment D Stone Plant Information Form (ATT D)**. Information from which includes counties sourced for Stone.

All labor, equipment and material to complete Placement/Restoring of Stone, Contract Item B shall be included in the unit bid price. Any traffic control required shall be charged per Section 3.2.22 of these Contract Specifications.

3.2.3 Performance Grade Binder, Contract Item E, is a surcharge to compensate Vendor for supplying asphalt when the referenced binder is substituted for the standard binder.

3.2.4 Haul by Vendor – Asphalt, Contract Item F, is the distance over suitable routes selected by the WVDOH District Engineer or their designee using the allowed for haul costs that will provide the lowest total cost to the WVDOH and shall be measured from the Vendor's plant location, which shall be identified on the **Attachment C Asphalt Plant Information Form (ATT C)** to the WVDOH's mid-point of the project.

REQUEST FOR QUOTATION
Asphalt Materials, Delivery & Labor by Vendor by County

The WVDOH shall source the WV Straight Line Diagrams for WV Primary Routes and WV Secondary Routes for these routes. The Diagrams are available in each WVDOH District Office and the WVDOH Central Office. WVDOH will determine the route to be taken due to bridge and/or road restrictions which shall have acceptable load limits for both roads and bridges.

Out-of-state delivery route mileage will be calculated by the WVDOH, the shortest route, by utilizing "Google Earth" or a similar source for routing from the Vendor's plant location to the WV State line at which time, the Diagrams will be sourced to the WVDOH mid-point of the projection location. **Haul by Vendor will only be requested in combination with other awarded items.**

3.2.5 Laydown of Materials, Contract Item G, shall provide Laydown services for Materials (**Contract Item A**). Laydown shall be provided by the Vendor at projects designated by the WVDOH District Engineer or their designee. When directed on the Delivery Order, the Laydown Contractor shall construct the Asphalt Laydown with a safety edge at no additional cost to the WVDOH.

3.2.6 Excavation for Shoulder Paving, Contract Item I, shall consist of removing existing shoulder material for a length and width as directed by the WVDOH District Engineer or their designee in two inch (2") vertical increments. Cost of loading, hauling, and disposing of the excavated materials shall be included in the bid price for this item.

Replacement of Asphalt Base, Asphalt Wearing or Shoulder Stone Aggregate will be paid as shown in Sections 3.2.7 and 3.2.8.

3.2.7 Asphalt Base I Shoulder Paving, Contract Item J, is a surcharge for work performed to pave road shoulders consisting of installing and compacting Asphalt Base I to the elevation of the existing pavement in the shoulder that is to be paved.

Vendor shall comply with **Repaving Pipe Trenches in Paved Shoulders, Exhibit 3 (EXH 3)**, where relevant work is performed.

NOTE the following Asphalt Base I related line Contract Items:

- Asphalt Base I will be paid as **Contract Item A**.
- Hauling of Asphalt Base I will be paid as **Contract Item F**.
- Laydown of Base I will be paid as **Contract Item G**.
- Excavation for Base I will be paid as **Contract Item I**.

REQUEST FOR QUOTATION
Asphalt Materials, Delivery & Labor by Vendor by County

3.2.8 Asphalt Base II Shoulder Paving, Contract Item K, is a surcharge for work performed to pave road shoulders consisting of installing and compacting Asphalt Base II to the elevation of the existing pavement in the shoulder that is to be paved.

Vendor shall comply with **Repaving Pipe Trenches in Paved Shoulders, Exhibit 3 (EXH 3)**, where relevant work is performed.

NOTE the following Asphalt Base II related line Contract Items:

Asphalt Base II will be paid as **Contract Item A3**.

Hauling of Asphalt Base II will be paid as **Contract Item F**.

Laydown will be paid as **Contract Item G**.

Excavation will be paid as **Contract Item I**.

Shoulder Stone Placement/Restoring, and Stone will be paid as **Contract Item B**.

3.2.9 Tack Coat, Contract Item L, Asphalt Material for Tack Coat or Prime Material furnished and applied shall be in accordance with Standard Specs Section 408, as amended, as directed by the WVDOH District Engineer or their designee.

3.2.10 Additional Heel-In Joints, Contract Item M, at the beginning and the end of each paving location will be performed by the Vendor in accordance with **Exhibit 4 Resurfacing Heel-In Detail (EXH 4)**. Additional Heel-In Joints, in accordance with the Resurfacing Heel-In Detail, may be required as directed by the WVDOH District Engineer or their designee at intersecting roadways, at the beginning and end of each paving skip, and at other designated locations. Payment of Additional Heel-In Joints shall be paid per lineal foot as measured along the joint, which shall be full payment for complete construction of the joint.

3.2.11 Skip Paving Surcharge, Contract Item N. Skip Paving may be requested by the WVDOH District Engineer or their designee. A Skip Paving Surcharge will apply when the distance between the end of one skip and the beginning of the next exceeds 2,500 feet. Skip paving for distances less than 2500 feet from the end of one skip and the beginning of the next will not qualify for the Skip Paving Surcharge. Payment shall be made for each ton of final surface course material completed in place on the project. Patching and leveling in preparation for resurfacing of a project shall not be considered Skip Paving.

3.2.12 Pavement Profiling/Milling shall consist of profiling the existing pavement to the specified grade and cross slope by grinding, planing, or milling. The profiling equipment shall be capable of accurately

REQUEST FOR QUOTATION
Asphalt Materials, Delivery & Labor by Vendor by County

establishing profile grades of ¼" plus or minus, along each edge of the machine by reference from the existing pavement by use of ski or matching shoe or by reference to independent grade control. The equipment shall have an automatic system for controlling grade and cross slope. The Vendor shall provide adequate manpower and auxiliary equipment to control dust and remove cuttings from the project site. Stockpiling of cuttings on the project site will not be permitted. **All cuttings shall become the property of the WVDOH.**

The Vendor shall be responsible for damage to drainage facilities, manholes or other appurtenances within the pavement area.

3.2.12.1 Pavement Profiling/Milling, Contract Items O, shall be measured as the total number of square yards planed or ground to a depth not exceeding two inches (2"). Should the required removal depth exceed two inches (2"), additional quantities shall be measured for each additional two inches (2") increment. Vendors shall factor in the haul cost of profiled/milled cuttings up to 10 miles, one way, in the bid price of this Contract Item.

3.2.12.2 Mobilization for Profiling/Milling, Contract Item P listed on **Attachment B Mobilization Pricing Pages (ATT B)**, all preparatory operations including movement of necessary personnel and equipment onto the project site to begin the profiling work. Only one Mobilization for Profiling per Delivery Order shall be paid when Pavement Profiling/Milling and identified accordingly from **Contract Item O** is required.

3.2.12.3 Haul of Profiled/Milled Cuttings, Contract Item Q: Profiled/Milled Cuttings from the project site may be by hauled by either WVDOH forces or the Vendor, as determined by the WVDOH District Engineer or their designee. Hauling of Profiled/Milled Cuttings by Vendor shall be to locations designated by the WVDOH District Engineer, or their designee. The first 10 miles, one way, Haul of Profiled/Milled Cuttings shall be included with the Pavement Profiling/Milling, **Contract Items O**, and shall not be charged for separately.

Haul of Profiled/Milled Cuttings beyond the initial 10 miles shall be bid per mile as **Contract Item Q2**. **Contract Item Q2** shall only be charged for mileage one way. Haul of Profiled/Milled Cuttings shall be for full capacity truckloads (legal truckloads) only, except for the last haul of the day, which permits the hauling of a partial load at the same rate.

REQUEST FOR QUOTATION
Asphalt Materials, Delivery & Labor by Vendor by County

3.2.13 Pavement Repair: Contract Item R. Pavement Repair, Contract Item R, is for pavement repair work performed in conjunction with an overlay. Pavement Repair shall consist of the squaring up the repair area, removing damaged material to a depth directed by the WVDOH District Engineer or their designee, hauling and disposing of existing pavement, tacking of existing surfaces and placing and compacting Asphalt Base II in lifts not exceeding two inches (2") to the level of the existing pavement. The cost of Asphalt Base II material shall be charged separately as **Contract Item A3**. Pavement Repair, **Contract Item R**, does not qualify for an Asphalt Price Adjustments; however, Asphalt Base II material used for Pavement Repair qualifies for price adjustment per Section 5 of these Contract Specifications.

All labor and equipment to complete **Contract Item R** shall be included in the unit bid price for **Contract Item R**. Any traffic control required shall be charged separately per Section 3.2.22 of these Contract Specifications and identified accordingly as **Contract Item AB**.

- **Base Failure Repair** shall be in accordance with **Base Failure Repair Detail, Exhibit 5 (EXH 5)**.
- **Edge Failure Repair** shall be in accordance with **Edge Failure Repair Detail, Exhibit 6 (EXH 6)**.
- **Pothole Repair** shall be in accordance with **Pothole Repair Detail, Exhibit 7 (EXH 7)**.

3.2.14 Attachment F SP401 Asphalt Base, Wearing and Patching, and Leveling Courses (ATT F), as amended, shall address the use of increased amounts of RAP used within mixes produced for projects in the WVDOH construction program.

3.2.15 Crushed Aggregate Base Course: RAP may be substituted for Class 10 Shoulder Stone materials on roadways where edge line pavement markings exist or are installed per Standard Specs Section 307, as amended.

3.2.16 Contract Item S shall be in accordance with **Attachment G Asphalt High Performance Thin Overlay, SP496 (ATT G)**, as amended. Laydown service shall be provided per Section 3.2.16.2 of these Contract Specifications.

REQUEST FOR QUOTATION
Asphalt Materials, Delivery & Labor by Vendor by County

3.2.16.1 Non-Tracking Tack, Contract Item T, is to be used with **Contract Item S**, shall be a MCS&T Approved Product from an Approved Vendor per MP, as amended, and shall meet the recommended requirements of the supplier unless otherwise specified by the WVDOH District Engineer or their designee.

3.2.16.2 Laydown of Materials, Contract Item U, shall provide Laydown services for **Asphalt HTPO, Contract Item S**. Any costs associated with the Material Transfer Device shall be included in the Vendor's bid price for Laydown. Laydown shall be provided by the Vendor at projects designated by the WVDOH District Engineer or their designee.

3.2.16.3 Asphalt HTPO, Contract Item S, shall be PG 64E - 22 ordered in 400 (four hundred) ton increments and **Contract Item U** shall also be requested in 400 (four hundred) ton increments or greater.

Hauling for **Contract Item S** shall be a separate bid item and not included in the combined material and Laydown price. Hauling shall be charged per **Contract Item F**.

3.2.17 Ultra-Thin Asphalt Overlay, Contract Item V, shall be in accordance with **Attachment H – SP498 Ultra-Thin Asphalt Overlay (ATT H)**, as amended. Laydown service shall be provided per Section 3.2.5 of these Contract Specifications.

3.2.18 Fine Milling of Asphalt Pavement Surfaces, Contract Item W, shall be the fine milling of existing and/or new asphalt pavement at locations shown on the plans or as directed by the WVDOH District Engineer or their designee in accordance with the Standard Test Method for Measuring Pavement Macrotexture Depth using a Volumetric Technique, MP 401.07.24. Vendor shall provide pricing inclusive of Laydown services.

3.2.19 Rumble Strips:

3.2.19.1 Milled Rumble Strips, Contract Item X, shall be in accordance with the **Exhibit 8 Rumble Strip Special Detail (EXH 8)**.

3.2.19.2 Mobilization for Milled Rumble Strips, Contract Item Y, on **Attachment B Mobilization Pricing Pages (ATT B)**, is all preparatory operations including movement of necessary personnel and equipment onto the project site to begin the work of Milling Rumble Strips. Only one Mobilization for Milling

REQUEST FOR QUOTATION
Asphalt Materials, Delivery & Labor by Vendor by County

Rumble Strips per Delivery Order shall be paid **when Milled Rumble Strips, Contract Item X**, is required.

- 3.2.20 Parking Lot and Facility Paving Surcharge, Contract Item Z**, is a surcharge which shall be provided when materials, **Contract Items A, S, and V**, are used to pave parking lots.
- 3.2.21 Cleaning and Sweeping, Contract Item AA**, shall be calculated as the paving length times the width swept. The WVDOH shall have the option to perform Cleaning and Sweeping.
- 3.2.22 Maintaining Traffic:** While undergoing improvement, the project site shall be kept open to traffic in such condition that both local and through traffic will be adequately and safely accommodated. All improvement operations shall be scheduled by the Vendor to keep traffic delay to a minimum.

Traffic Control may be furnished by the WVDOH at the option of the District Engineer, or their designee; however, when Pilot Truck and Driver, Traffic Control Devices, Flagger, and/or Arrow Board, **Contract Item AB**, are requested by the WVDOH District Engineer or their designee for a project, traffic shall be maintained by the Vendor in accordance with Standard Specs Section 636, as amended.

- 3.2.23 Mobilization for Paving Limits:** Vendor shall use **Attachment B Mobilization Pricing Pages (ATT B)** to provide pricing for all Mobilization Contract Items.

Attachment B Mobilization Pricing Pages (ATT B) Contract Items are:

- **Contract Item C** is for Shoulder Stone Mobilization
- **Contract Item H1** is for DAYTIME Paving Mobilization
- **Contract Item H2** is for NIGHTTIME Paving Mobilization
- **Contract Item P** is for Pavement Profiling Mobilization
- **Contract Item Y** is for Milled Rumble Strips Mobilization

Only one mobilization for paving per day of operation will be paid, unless moves of over five (5) miles between individual paving locations are required. In cases where a Vendor is required to move from one roadway to the adjacent roadway of a divided highway, additional mobilization for paving will only be paid if the nearest interchange or crossing point that will accommodate the Vendor's equipment is over five (5) miles from the paving locations.

REQUEST FOR QUOTATION
Asphalt Materials, Delivery & Labor by Vendor by County

3.2.23.1 Daytime Paving Mobilization, Contract Item H1, is a mobilization for paving charge which may be made when the Delivery Order quantity, per paving location, is less than 500 tons of Asphalt and nighttime paving is not requested.

3.2.23.2 Nighttime Paving Mobilization, Contract Item H2, is a mobilization for paving charge which may be made when the Delivery Order directs that the paving is to be done at night.

NOTE: This provision may require roundtrip moves of up to ten (10) miles with no additional mobilization for paving payment. An individual paving location shall be defined as a paving job where no skips exceeding 2,500 feet are involved, except between the approach slabs of a bridge or parallel pair of bridges.

3.2.24 Off-Season Plant Opening, Contract Item AC, are necessary if a Vendor is required to open their plant in the off-season to service the needs of the WVDOH, in which case an additional payment will be made. The Vendor will be paid an additional day charge for each additional consecutive day that the plant is open after the first day to service the needs of the WVDOH. If the plant produces no material for any use on any calendar day, either during the week or on the weekend, the WVDOH will pay the first day rate for off-season plant opening on the next day of the WVDOH usage. Payment for this item is subject to the following conditions:

3.2.24.1 Payment for this item can only be authorized and made during the winter months, i.e., between December 15th and March 15th, and then only if the plant would not have otherwise been open. These dates may be revised by the WVDOH District Engineer or their designee, if necessary, to meet specific needs in the field. Any such revision of dates will be in writing and shall be attached to the Vendor's invoice at the time payment is requested.

3.2.24.2 Payment will always be made at the full contract awarded bid price for the first day of plant opening; however, the amount paid from each additional day of plant opening will be reduced as follows:

A. Payment for additional day charge will not be made if the plant has produced over 500 tons on that day. If between 300 and 500 tons have been produced, payment for additional day charge will be made equal to one-half of the

REQUEST FOR QUOTATION
Asphalt Materials, Delivery & Labor by Vendor by County

contract awarded bid price for the additional day charge. The quantity produced to make this determination shall include all material produced that day, which includes tonnage bought by the WVDOH, other local governments and all private work.

- B.** The WVDOH will only pay its share of the amount determined to be due for additional day charge as described above. For example, if the plant produces 375 tons and the WVDOH takes 150 tons of the total, 40% of the plant's daily production, payment for additional day charge would be calculated as follows: Since the total daily production is between 300 and 500 tons, the Vendor is due 50% of the additional day charge. Because the WVDOH's share of this daily production is 40%, the WVDOH would pay 40% of one-half of the additional day charge, or in this case, 20% of the additional day charges.

3.2.24.3 A certified statement shall accompany the invoice stating the total quantity produced on the additional day. If payment does not qualify due to tonnage produced, the next consecutive day of plant operation, if any, will qualify for payment at the additional day rate rather than the first day rate for plant opening.

3.2.25 Vendor's Asphalt Plant Location: The Vendor shall provide on **Attachment C Asphalt Plant Information Form (ATT C)** the Vendor's Asphalt Plant Location which will be supply the materials listed on the **Attachment A Pricing Pages (ATT A)** spreadsheet. Reference Section 7.2.2 of these Contract Specifications.

3.2.26 Emergency Work: Emergency work as ordered by WVDOH District Engineer or their designee is work that shall be initiated within forty-eight (48) hours from when the Delivery Order is received by the vendor. The determination of emergency work will be in accordance with Section 2.7 of these Contract Specifications. Emergency Work must be prominently noted on Delivery Order. Designated emergency projects will be paid at 1.50 times the vendors bid price.

4. SAFETY

Pandemic-Response Safety Protocols: In addition to the Vendor's established safety protocols and the WVDOH's established safety protocols outline in the Standard Specs,

REQUEST FOR QUOTATION
Asphalt Materials, Delivery & Labor by Vendor by County

as amended, the Vendor and the Vendor's staff shall adhere to all WVDOH's pandemic-response protocols while present at the WVDOH jobsite. Vendors may obtain the WVDOH's pandemic-response protocols by contacting the WVDOH District Engineer or their designee.

5. PRICE ADJUSTMENTS:

5.1 Price Adjustment of Asphalt Cement: Due to the uncertainty in estimating the cost of petroleum products that will be used during the life of this contract, adjustment in compensation for **Contract Items A, S and V** is provided for in the Standard Specs, as amended. Refer to the table below:

Contract Item	Description of Asphalt Section	AC (Average Asphalt Content)
A1	Section 401 – Base I	3.9
A2	Section 401 – 25mm Superpave	4.4
A3	Section 401 – Base II	5.0
A4	Section 401 – Patch and Level	5.0
A5	Section 401 – Wearing IV	5.2
A6	Section 402 – Wearing IV	5.1
A7	Section 401 – 19mm Superpave	4.7
A8	Section 401 – Scratch Course	6.2
A9	Section 402 – 9.5mm Superpave	6.1
A10	Section 401 – Wearing I	6.1
A11	Section 402 – Wearing I	6.0
A12	Section 401 – 4.75mm Superpave	7.6
A13	Section 402 – 4.75mm Superpave	7.2
A14	Section 401 – Wearing III	7.3
A15	Section 402 – Wearing III	7.5
A16	Section 401 - 12.5mm Superpave	5.6
A17	Section 402 - 12.5mm Superpave	5.6
S	Asphalt HPTO, SP496	7.1
V	Ultra-Thin Asphalt Overlay, SP498	7.6

5.2 Price Adjustment of Fuel Oil No. 2 (Diesel Fuel): Due to the uncertainty in estimating the cost of diesel fuel that will be used during the life of this contract, adjustment in compensation for **Contract Items A, S and V** is provided for in the Standard Specs, as amended.

REQUEST FOR QUOTATION
Asphalt Materials, Delivery & Labor by Vendor by County

The bidding index for Asphalt Binder will be listed on the Contract Administration website for Fuel, Asphalt and Cement Prices Adjustments listed for January 2021.

<https://transportation.wv.gov/highways/contractadmin/Lettings/Pages/FuelandAsphaltPrices.aspx#FuelPrices>.

6. **ACCEPTANCE PLAN:** Quality control at the plant and in-the-field shall be the responsibility of the Vendor and shall meet the requirements of MP 401.03.50. Compaction quality control shall be in accordance with MP 401.05.20. Acceptance testing shall be the responsibility of the WVDOH. Quality assurance of the material shall be as set forth in MP 401.02.27 for Marshall Mix designs or MP 401.02.29 for Superpave mix designs. Referenced MP's, as amended, may be referenced at <https://transportation.wv.gov/highways/mcst/Pages/MP-400s.aspx>.

7. **CONTRACT AWARD:**

- 7.1 **Contract Award:** The Contract is intended to provide Agencies with a purchase price on all Contract Items. All qualified responsible Vendors shall be awarded a contract for those Contract Items bid which meet all mandatory requirements of this Contract.
- 7.2 **Pricing Pages and Plant Information Forms:** A complete bid submission SHALL include multiple Attachments to include Pricing Pages AND corresponding Plant Information Forms.
- Vendor shall clearly identify the applicable counties on **Attachment A Pricing Pages (ATT A)** Pricing Page by marking an "X" beside applicable county/counties.
 - Vendor shall clearly identify their bid, by county, on **Attachment B Mobilization Pricing Pages (ATT B)** by providing a lump sum price beside the applicable county/counties for each mobilization Contract Item they are bidding on, as listed in Section 3.2.23 of these Contract Specifications.
 - Vendor shall list with each materials plant location which will provide the materials listed on the **Pricing Pages (ATT A)**, each plant location listing on **Attachment C Asphalt Plant Information Form (ATT C)** and **Attachment D Stone Plant Information Form (ATT D)** must also list the counties which the listed plant location serves.
 - Vendor shall submit one complete set of Pricing Pages and Plant Information Forms for each county or grouping of counties with identical pricing. If bid prices differ across counties, the Vendor shall make duplicates of the Pricing

REQUEST FOR QUOTATION
Asphalt Materials, Delivery & Labor by Vendor by County

Pages (ATT A and ATT B) and Plant Information Forms (ATT C and ATT D) and submit a new, separate, complete set of Pricing Pages and Plant Information Forms for each differing set of prices, identifying the applicable counties on each separate set.

NOTE: If the Vendor fails to provide the Asphalt (ATT C) or Stone (ATT D) Plant Location Information Form that corresponds with the Vendor's Pricing Pages (ATT A and ATT B), the Vendor's bid will be DISQUALIFIED for that bid submission.

7.2.1 Pricing Pages Spreadsheet: Vendor should complete the Pricing Pages spreadsheet by providing the following information for each Contract Item Bid:

- **Supplier Name - Vendor's Sourced Plant:** Vendor should identify the Vendor's sourced Plant name and this listing should correspond with Vendor's completed, mandatory Plant Information forms, **Attachment C Asphalt Plant Information Form (ATT C)** and **Attachment D Stone Plant Information Form (ATT D)**.
- **List Price:** Vendor shall list their bid per unit prices for each Contract Item they intend to bid. Vendor should not place formulas or any type of Excel calculations into the List Price column, only the actual bid price per Contract Item.

NOTE: Vendor shall not add to or modify any column headers, Contract Item descriptions, or units of measure on the Pricing Page spreadsheets. Any changes to the latter will result in disqualification of the Vendor's bid.

The Pricing Pages spreadsheets list Contract Items with no guarantee that any Contract Item will be purchased throughout the life of this contract. Estimated quantities are not available.

Vendors may bid any or all Contract Items on the Pricing Pages spreadsheet. Bidding on any one Contract Item may not be conditioned on the acceptance of the bid on any other Contract Item(s).

7.2.2 Plant Information Forms: There are two (2) Plant Information Forms that must be submitted with corresponded Pricing Pages at the time of Bid: **Attachment C Asphalt Plant Information Form (ATT C)** identifies the Asphalt Plant and **Attachment D Stone Plant Information Form (ATT D)** identifies the Stone Plant for Shoulder Stone placement.

REQUEST FOR QUOTATION
Asphalt Materials, Delivery & Labor by Vendor by County

All Plant Information Forms shall be completed by Vendors and shall identify WVDOH Approved Plants, as amended, supplying materials associated with bid items on the Pricing Pages. A “COMPLETE” Plant Information Forms shall provide:

- Name of Vendor submitting the Plant Information Form as part of bid
- Plant Name
- Plant Location - 911 address or the most recent physical street address, city, and state
- Counties the listed Plant will supply the Vendor’s materials to

NOTE: If the Vendor fails to provide the Asphalt (ATT C) or Stone (ATT D) Plant Location Information Form that corresponds with the Vendor’s Pricing Pages (ATT A and ATT B), the Vendor’s bid will be DISQUALIFIED for that bid submission

7.2.3 Electronic Forms: Vendor should type or electronically enter the information into the Pricing Pages spreadsheet and the Plant Information Forms to prevent errors in the evaluation. In most cases, the Vendor can request an electronic copy of the Pricing Pages spreadsheets (ATT A & ATT B) and Plant Information Forms (ATT C & ATT D) for bid purposes by sending an email request to the following address:
Kristy.E.James@wv.gov.

7.3 Contract Award Transition: Upon the award of this contract, whether the effective date or the completed and encumbered date or an established date by the WVDOH, the WVDOH Operations Division will announce the effective date of use of this contract to the Districts and the Vendors. Upon the announced effective date of use by the WVDOH Operations Division to the Districts and Vendors, any Delivery Order issued toward the 2020 Contracts for material, delivery and labor by the vendor shall remain in effect and should not be cancelled until that Delivery Order is filled; however, after ten (10) working days of the Districts’ and Vendors’ notice, any Delivery Order that has not been completely filled by the Vendors from the 2020 Contracts for material, delivery and labor by the vendor shall NOT be completed, but a cancellation notice will be sent to that Vendor from the issuing District for cancellation of the balance of that Delivery Order only. No Delivery Order from the 2020 Contracts for material, delivery and labor by the vendor should be held open by the District or the Vendor longer than ten (10) working days after the notice to the Districts and the Vendors of the effective date of use of the new contracts.

REQUEST FOR QUOTATION
Asphalt Materials, Delivery & Labor by Vendor by County

This directive is issued to assist the Districts and the Vendors when fulfilling open Delivery Orders only. It is NOT issued to cause harm or to take contracts from one Vendor to give to another Vendor, but to establish a transition process from one contract into another contract.

- 8. DETERMINING LOW BID PER PROJECT:** To determine the low bid Vendor for individual repair paving projects, the WVDOH District Engineer or their designee will calculate the lowest overall total cost of the Contract Items required for individual projects. A written Delivery Order will be issued to the Vendor with the lowest overall total cost. Charges for hauling will be calculated according to Section 3.2.4 of these Contract Specifications.

WVDOH reserves the right to request any one or combination of items for which bids are awarded at the lowest overall total as set forth in this section.

9. ORDERING AND PAYMENT:

- 9.1 Ordering:** Vendor shall accept orders through wvOASIS, regular mail, facsimile, e-mail, or any other written forms of communication. Vendor shall maintain and keep current its phone numbers, fax number, e-mail address, locations and ordering/billing/ payment addresses with WVDOH and in wvOASIS. Vendor may, but is not required to, accept online orders through a secure internet ordering portal/website. If Vendor can accept online orders, it should include in its response a brief description of how Agencies may utilize the online ordering system. Vendor shall ensure that its online ordering system is properly secured prior to processing Agency orders online.
- 9.2 Delivery Order:** WVDOH will initiate the Delivery Order by identifying locations of need. The Delivery Order will be generated by a WVDOH Engineer or their designee. The order should be completed on a WV-39 Blanket Release Order. The order should detail the need and location information of the work to be completed per Contract Items, as well as the tentative start and end dates, to become the agreed up as the official start and end dates. Emergencies shall be prominently noted on the Delivery Order. Once complete, the Delivery Orders shall be sent to Vendor via fax, email, or postal mail. **Any verbal communications to initiate or make modifications to a project from this contract are not acceptable as a Delivery Order.**
- 9.3 Payment:** Upon completion of the work indicated on the Delivery Order, Vendor shall accept payment in accordance with the payment procedures of the State of West Virginia. The State of West Virginia currently utilizes a Purchasing Card program, administered under contract by a banking institution, as well as

REQUEST FOR QUOTATION
Asphalt Materials, Delivery & Labor by Vendor by County

Electronic Funds Transfer as methods to process payment for goods and services. The Vendor shall accept the State of West Virginia's Purchasing Card and Electronic Funds Transfer for payment of orders under this Contract. Electronic Funds Transfer for payment is available through the WV State Auditor's Office. The Vendor may visit the WV State Auditor's website (wvsao.gov) for all necessary forms and instructions. Payment method may be dictated at WVDOH's discretion.

10. PROJECT ACCEPTANCE, DELIVERY AND RETURN:

- 10.1 Project Acceptance and Written Verification of Receipt:** Upon receipt of a WVDOH Delivery Order, the Vendor shall advise the WVDOH in writing within five (5) calendar days of their acceptance or refusal of the Delivery Order. As verification of receipt, Vendor must provide written acknowledgement of any Delivery Orders and any Revisions/Modifications thereto sent by WVDOH. Failure to provide the WVDOH with written acknowledgement of any Delivery Orders/Revisions within five (5) calendar days of the Order being sent shall be considered refusal of the Delivery Order. In the event of refusal, the WVDOH at its own discretion shall cancel the Delivery Order and may seek to cancel the Delivery Order and obtain the goods or services from the next low bid Vendor or proceed with an Emergency Purchase from the open market.
- 10.2 Negotiation of Dates:** The WVDOH shall have the option to negotiate with the Vendor the project's tentative start and end dates. **Project work shall be continuous to completion unless otherwise approved in writing by the WVDOH District Engineer or their designee.**
- 10.3 Lead Time:** The WVDOH should plan accordingly to allow the Contractor a minimum of fourteen (14) calendar days prior to the date of the agreed upon work start date on the Delivery Order to allow Vendor to mobilize and begin work.
- 10.4 Delivery Time:** The Vendor shall mobilize, commence, and complete work delivery in accordance with the WVDOH's written Delivery Order, per project. Any changes must be communicated by the Vendor in writing to the WVDOH District Engineer or their designee. The Vendor shall work in an efficient manner in effort to keep traffic delay to a minimum and traffic must be adequately and safely accommodated. Vendor shall ship/provide all orders in accordance with the dates assigned to each project per the Delivery Order and shall not hold orders until a minimum delivery quantity is met. **No Vendor is authorized to ship project related goods or begin work/services, nor is the WVDOH authorized to receive materials, prior to the issuance of a Delivery Order.**
- 10.5 Adverse Weather Conditions:** Unsuitable/adverse/inclement weather conditions

REQUEST FOR QUOTATION
Asphalt Materials, Delivery & Labor by Vendor by County

may dictate the work schedule. It is preferred that operations be suspended immediately when an inclement weather event begins or if the WVDOH District Engineer or their designee determines that an inclement weather event is imminent. If working conditions are dangerous or unsuitable for the WVDOH, Vendor, or the general public, work shall be suspended by the WVDOH Engineer or their designee. If needed, revision to the project's start and end date may be negotiated by the Vendor and the WVDOH Engineer or their designee. After a weather-related suspension of work, the WVDOH District Engineer or their designee shall determine and convey in writing, such Delivery Order changes and when work shall commence/resume, followed by the Vendor's written acknowledgement, as per Section 9 of these Contract Specifications.

10.6 Late Delivery: If commencement of work by the Vendor will be delayed for any reason, the Agency placing the Delivery Order under this Contract must be notified **in writing by the Vendor by no later than five (5) business days prior to the scheduled start date from the Agency's order.** Any failure to notify, acknowledge receipt of WVDOH's written Delivery Orders/ Revisions resulting in delivery delay, or failure to start or complete the project per the WVDOH scheduled due dates may be determined by the WVDOH at its sole discretion as harmful to the Agency and as such, shall result in WVDOH's cancellation of the Delivery Order and application of Liquidated Damages.

10.6.1 Liquidated Damages: If the Vendor's work completion or corrections of deficient work exceeds the Delivery Order completion due date/timeframe, the Vendor shall agree that no extension of contract time will be granted unless Liquidated Damages are applied by the WVDOH in the form of an off-set reduction to the total amount of the Vendor's final invoice. The WVDOH shall calculate Liquidated Damages per project beginning on day one (1) after the WVDOH's specified Delivery Order due date, in accordance with this Section, the contract's Terms and Conditions, and the Standard Specs Section 108.7, as amended.

10.7 Delivery Payment/Risk of Loss: Standard order delivery shall be F.O.B. Vendor's Plant Location. **Haul by Vendor, Contract Item F,** shall be requested on the Delivery Order. Vendor shall include the cost/discount of standard order delivery charges in its bid pricing and is not permitted to charge the Agency separately for such delivery.

10.8 Project Acceptance Criteria: The WVDOH District Engineer or their designee shall have final acceptance of the work done by the Vendor, per project. Any work found by the WVDOH District Engineer or their designee not performed in accordance with these contract Specifications and the Standard Specs, as amended, and/or found deficient and unacceptable by visual inspection will be rejected and, at the Vendor's/Contractor's expense, will be removed and replaced

REQUEST FOR QUOTATION
Asphalt Materials, Delivery & Labor by Vendor by County

by the Vendor with work being continual until the Vendor's deficient work corrections are completed and deemed acceptable and approved by the WVDOH District Engineer or their designee. Under no circumstance shall the Vendor's deficiency corrections exceed twenty (20) calendar days unless otherwise declared in writing by the WVDOH District Engineer or their designee, subject to Liquidated Damages as per Section 10.6.1 of these Contract Specifications.

- 10.9 Rejection of Unacceptable Contract Items:** The decision of the WVDOH District Engineer or their designee regarding materials, workmanship, quality etc., shall be final per the Standard Specs **Section 105**, as amended. If the Agency deems the Contract Items to be unacceptable, the Contract Items shall be returned to Vendor at Vendor's expense and with no restocking charge. Within five (5) days of being notified that items are unacceptable, Vendor shall either make arrangements for the return, or permit the Agency to arrange for the return, and reimburse Agency for delivery expenses. All returns of unacceptable items shall be F.O.B. the Agency's location. The returned product shall either be replaced, or the Agency shall receive a full credit or refund for the purchase price, at the Agency's discretion.
- 10.10 Return Due to Agency Error:** Items ordered in error by the Agency will be returned for credit within 30 days of receipt, F.O.B. Vendor's location. Vendor shall not charge a restocking fee if returned products are in a resalable condition. Items shall be deemed to be in a resalable condition if they are unused and in the original packaging. Any restocking fee for items not in a resalable condition shall be the lower of the Vendor's customary restocking fee or 5% of the total invoiced value of the returned items.

11. VENDOR DEFAULT:

- 11.1** The following shall be considered a vendor default under this Contract:
- 11.1.1** Failure to provide Contract Items in accordance with the requirements contained herein.
 - 11.1.2** Failure to comply with other specifications and requirements contained herein.
 - 11.1.3** Failure to comply with any laws, rules, and ordinances applicable to the Contract Services provided under this Contract.
 - 11.1.4** Failure to remedy deficient performance upon request.
- 11.2** The following remedies shall be available to Agency upon default:

REQUEST FOR QUOTATION
Asphalt Materials, Delivery & Labor by Vendor by County

11.2.1 Immediate cancellation of the Contract.

11.2.2 Immediate cancellation of one (1) or more Delivery Orders issued under this Contract.

11.2.3 Any other remedies available in law or equity.

12. MISCELLANEOUS:

12.1 No Substitutions: The Vendor shall supply only Contract Items submitted in response to the Solicitation unless a contract modification is approved in accordance with the provisions contained in this Contract.

12.2 Vendor Supply: The Vendor must carry sufficient inventory of the Contract Items being offered to fulfill its obligations under this Contract. By signing its bid, the Vendor certifies that it can supply the Contract Items contained in its bid response.

12.3 Vendor's Invoices: Invoices for materials, **Contract Items A, R, U, and S**, must be submitted separately from all other items. All other items shall be submitted on a separate invoice. The Vendor's invoices must be submitted as an original containing the following information:

- All weigh ticket numbers for material delivered and cuttings hauled during the invoice period.
- WVDOH Delivery Order number and this contract number.
- Total quantity and unit price with the total cost of each type of material furnished.
- No payment will be made to a Contractor for **Daytime Paving Mobilization, Contract Item H1**, unless the quantity is less than 500 tons or **Nighttime Paving Mobilization, Contract Item H2** unless the Delivery Order directs that the paving is to be done at night.

12.4 Reports: The Vendor shall provide quarterly reports and annual summaries to the Agency showing the Contract Items purchased, quantities of Contract Items purchased, and the total dollar value of the Contract Items purchased. The Vendor shall also provide reports, upon request, showing the Contract Items purchased during the term of this Contract, the quantity purchased for each of those Contract Items and the total value of purchases for each of those Contract Items. Failure to supply such reports may be grounds for cancellation of this Contract.

REQUEST FOR QUOTATION
Asphalt Materials, Delivery & Labor by Vendor by County

12.5 Contract Manager: During its performance of this Contract, Vendor must designate and maintain a primary Contract Manager responsible for overseeing Vendor's responsibilities under this Contract. The Contract Manager must be available during normal business hours to address any customer service or other issues related to this Contract. In the event that the Contract Manager or any of the Vendor's contact information, email, addresses, or phone numbers change, the Vendor shall update the WVDOH in writing and update wvOASIS. Vendor should list its Contract Manager and his or her contact information below.

Contract Manager: William Alan O'Brien
Telephone Number: 304-647-4296
Fax Number: 304-645-4610
Email Address: gep@wvdsl.net

WEST VIRGINIA DEPARTMENT OF TRANSPORTATION**DIVISION OF HIGHWAYS****SPECIAL PROVISION****FOR****STATEWIDE ASPHALT MATERIALS, DELIVERY****& LABOR BY VENDOR BY COUNTY****CONTRACT 6621C044, ATTACHMENT F****SECTION 401****ASPHALT BASE, WEARING, AND PATCHING AND LEVELING
COURSES**

ADD THE FOLLOWING SUBSECTION TO THE SECTION:

401.4.3-Increase of Reclaimed Asphalt Pavement (RAP) in Asphalt Concrete Mixes: This Special Provision has been written to address the use of increased amounts of reclaimed asphalt pavement (RAP) used within mixes produced for projects in the WVDOH construction program.

The increased use of RAP can become an effective measure to help reduce overall construction costs and ultimately allow the WVDOH to treat more mileage within the established annual budgets. This will also allow the WVDOH to accomplish savings while at the same time, doing so in an environmentally responsible manner. However, it is important that any steps taken to use increased amounts of RAP be performed in a manner that will also not be detrimental to the quality of the asphalt concrete mixes produced.

The WVDOH will allow the increased use of RAP in Marshall Base 1 and Base 2, and Superpave 19 mm, 25 mm, and 37.5 mm mixes up to 25%. Initially, all mix designs shall be submitted in accordance to MP 401.02.24, with the exception that Section 5.0, Line 5.4 pertaining to RAP contents between 16% and 25% will be waived. The addition of up to 25% RAP will be allowed in Marshall Base 1, and Superpave 25 mm and 37.5 mm mixes for all applications provided that the processing of RAP is consistent with that discussed for State Funded projects below. For Marshall Base 2 and SP 19 mm, the following criteria shall be used for acceptance during production:

401.4.3.1-Interstates, APD Corridors, and Multilane Roadways:

- a) **Superpave 401 projects with PWL factors:** 25% RAP Base 2 or SP 19mm will be allowed.
- b) **All other projects will require one random loose roadway sample per 1000 ton placed.** Samples will be taken generally as per MP 401.07.21, by the Contractor along with WVDOH personnel. Each sample then will be tested by the Contractor in order to determine AC and gradation, and all such testing shall be witnessed by the WVDOH. The contractor must have an established ignition oven correction factor for both AC Content and gradation for each mixture. In addition this correction factor must be established prior to the project and will only be valid during the paving season it was established. All

sample results for AC and Gradation shall then be evaluated for additional pay factors as per Table 401.13.3.1 of the SP 401 Square Yard PWL, then applied in the formula shown below. The results for AC and gradation (minus #200) from QC samples at the plant will not be used for determination of pay adjustment. A lot will be 5,000 tons or portion thereof with a minimum of three samples. Portions less than 2,000 tons shall be incorporated into the previous lot. There will be no incentive for PWL from 96 to 100.

$$\text{Pay Deduction per Ton or SY (\%)} = \frac{100 - [(PF_{AC} + PF_G) / 2]}{2}$$

401.4.3.2-Other Federal Aid and NHS routes:

- a) WVDOH will monitor plant QC Samples for AC and gradation for the mix being produced. The contractor must have an established ignition oven correction factor for both AC Content and gradation for each mixture. In addition this correction factor must be established prior to the project and will only be valid during the paving season it was established. These results shall then be evaluated for additional pay factors as per Table 401.13.3.1 of SP 401 Square Yard PWL, and then applied in the formula shown below. A lot will be five samples or portion thereof with a minimum of three samples. Testing frequency shall be a minimum of 1 sample per 1,000 tons of daily production (maximum of 750 tons for adjusted sublots) and shall include gradation and AC content for each sample. There shall be at least one sample per day of production. Lots may cover more than one project, but no more than three. Any penalties calculated shall be applied to all the material represented by the testing of the evaluated lot. Portions less than two samples shall be incorporated into the previous lot. There will be no incentive for PWL from 96 to 100.

$$\text{Pay Deduction per Ton or SY (\%)} = \frac{100 - [(PF_{AC} + PF_G) / 2]}{2}$$

401.4.3.3-State Funded Projects (including Marshall Wearing IV or Superpave 19mm may be used as surface mix on routes with ADT below 3000):

- a) Process for addition of RAP shall include initial scalping to remove + 3/4" (19 mm) material and proper stockpile management in accordance with Best Practices for RAP Management as documented by NCHRP report 752, Appendix D, and as discussed in Publication No. FHWA-HRT-11-0-21. These documents can be accessed at the respective links below:

http://onlinepubs.trb.org/onlinepubs/nchrp/nchrp_rpt_752.pdf

<http://www.fhwa.dot.gov/publications/research/infrastructure/pavements/11021/11021.pdf>

The submission of mix designs shall be done in the same manner as described for Marshall Base 2/Superpave 19 mm above and production shall be monitored as described above for other Federal Aid or NHS Routes.

WEST VIRGINIA DEPARTMENT OF TRANSPORTATION**DIVISION OF HIGHWAYS****SPECIAL PROVISION****FOR****STATEWIDE ASPHALT MATERIALS, DELIVERY****& LABOR BY VENDOR BY COUNTY****CONTRACT 6621C044, ATTACHMENT G****SECTION 496****ASPHALT HIGH PERFORMANCE THIN OVERLAY****496.1-DESCRIPTION:**

This work shall consist of constructing a single course of an asphalt high performance thin overlay (HPTO), mixed mechanically in a plant, composed of aggregate and asphalt material designed in accordance with the Superpave Design System, on a prepared foundation in accordance with these specifications and in reasonable close conformity with the lines, grades, weights or thicknesses, and cross sections shown on the Plans or established by the Engineer.

The unit of measurement for HPTO will be either by the ton (megagram) or square yard (square meter).

The work will be accepted in accordance with these Specifications and the applicable requirements of Sections 105, 106, and 109.

496.2-MATERIALS:

The materials shall conform to the following requirements:

MATERIAL	SUBSECTION
Coarse Aggregate ^{Note-1 & 2}	703.1 thru 703.3 (See MP 401.02.28 for exceptions and additions required for Superpave aggregates)
Fine Aggregate ^{Note-2}	702.3 (See MP 401.02.28 for additions required for Superpave aggregates)
Mineral Filler	702.4
Non-Tracking Asphalt Material	705.13
PG 64E-22 Performance Graded Binder for Mixture	705.5

MATERIAL	SUBSECTION
PG 64S-22 Performance Graded Binder for Tack Coat	705.5

Note-1: The total coal and other lightweight deleterious material and friable particles shall not exceed 1.0%.

Note-2: All aggregate shall be 100% crushed and come from a source identified as approved for polish resistant aggregate meeting the requirements of Section 402

CONSTRUCTION METHODS

496.3-GENERAL:

Construction methods to be used in performing the work shall be submitted to the Engineer for review prior to the start of work. This review may require modification of the proposed methods to provide the desired end product. All equipment, tools, machinery, and plant shall be maintained in a satisfactory working condition.

496.4-COMPOSITION OF MIXTURES:

496.4.1-General: The aggregate for use in the designated mixture shall consist of a mixture of aggregate (coarse and fine) and mineral filler as required. Reclaimed asphalt pavement (RAP) shall not be used in a HPTO mix.

496.4.2-Job Mix Formula: The Job Mix Formula (JMF) is the specification for a single mix produced at a single plant. This mix may be specific to a single project or be used on multiple projects if the basic design criteria (aggregate gradation, design compaction level and PG Binder grade) are the same.

The Contractor shall submit a proposed JMF for each combination of aggregate and asphalt material for HPTO to be produced. The JMF gradations shall be within the tolerances set forth in Table 496.4.2A.

The HPTO design shall be developed using the guidelines of MP 401.02.28, with the exception that the volumetric properties shall meet the requirements of Table 496.4.2B. The percent voids-filled-with-asphalt (VFA) requirement of the MP shall be waived.

Each proposed JMF must be documented on the Division Form T400SP and the entire JMF package shall be forwarded for review to the District Materials Engineer/Supervisor. After review and verification of completeness the T400SP and JMF package shall then be forwarded to the Materials Control, Soils and Testing Division (MCS&T) for final review. If the JMF requires revision, it will be returned to the designer through the District. The T400SP Form shall contain the following information:

- i. Identification of the source and type of materials used in the design.
- ii. The aggregate blend percentages and the percentage for each sieve fraction of aggregate considered the desirable target for that fraction.
- iii. The percentage of asphalt binder representing the optimum asphalt content for the JMF submitted, which is to be considered the desirable target percentage.

- iv. The temperature of the completed mixture at the plant which shall be within ± 25 °F (± 14 °C) of the median mix temperature established by the temperature-viscosity chart or as recommended by the asphalt supplier.
- v. The ratio (calculated to the nearest one-tenth percent) of the fines to effective asphalt.
- vi. The amount and type of anti-strip agent, if used.

Standard Sieve Size	Percent Passing
1/2 in. (12.5 mm)	100
3/8 in. (9.5 mm)	90-100
No.4 (4.75 mm)	95 max
No.8 (2.36 mm)	30-60
No.16 (1.18 mm)	25-40
No.30 (600 μ m)	15-30
No.50 (300 μ m)	10-25
No.100 (150 μ m)	5-15
No. 200 (75 μ m)	4-12
Asphalt Content	7.0 Min

TABLE 496.4.2B

Design Volumetric Property Requirements for HPTO Mix Design ^{Note-3}	
Design Criteria	Ndesign
Number of Design Gyration	50
Air Voids (%)	3.0
Voids-in-Mineral Aggregate (%)	18.0 minimum
Fines-to-Effective Asphalt Ratio	0.6-1.2
Tensile strength ratio (AASHTO T283) ^{Note-3}	85% minimum

Note 3: If the tensile strength ratio (TSR) is less than 85% without an anti-stripping agent, then an anti-stripping agent may be added and the mixture retested. If retesting with the agent still produces a TSR of less than 85% then a new mix design will be required.

If it becomes necessary to change aggregate sources, a new mix design shall be developed and submitted for approval. The source of the polymer modified binder may only be changed if the source is another facility owned and operated by the same company as the original source. The new facility shall submit verification that the binder is produced in the same manner and with the same grade and amount of polymer material as the original source. They shall also verify that the blending of the two binders in the same storage tanks will not have an adverse effect on the properties of the binder grade in use.

496.5-TESTING:

496.5.1-Test Methods: Test methods shall be those listed in Section 401.5.1.

496.6-CONTRACTORS QUALITY CONTROL:

496.6.1-Quality Control Testing: Quality control of HPTO is the responsibility of the Contractor. The Contractor shall maintain equipment and qualified personnel including at least one certified HMA asphalt technician at each plant. The technician shall be in charge of all plant quality control activities such as mix proportioning and adjustment and all sampling and testing activities necessary to maintain the various properties of HPTO within the limits of the specification.

The Contractor shall maintain equipment and qualified personnel including at least one certified Compaction Technician at each project. A certified Compaction Technician shall perform all testing necessary to assure compaction of the HPTO meets specification requirements. The Contractor, or Contractor-Producer, shall design a workable Quality Control Plan, detailing the type and frequency of sampling and testing deemed necessary to measure and control the magnitude of the various properties of the HPTO governed by these Specifications. This plan, prepared in accordance with MP 401.03.50 shall be submitted to the Engineer for review prior to production of material under this Specification.

496.6.2-Quality Control Testing Requirements: Test requirements for quality control shall be as set forth in MP 401.02.29, with the exception that the job mix formula field design verification and quality control testing for HPTO shall be monitored for conformance to the mix property requirements of Table 496.6.2. Additionally, the minimum quality control sampling frequency shall be one random sample per every 750 tons of HPTO mixture delivered to the project. In order to evaluate conformance to the specifications using MP 401.02.29, all job mix formula field design verification and quality control samples obtained for the project shall be used in the moving average calculations and the final evaluation of all test data shall be project specific.

TABLE 496.6.2

Quality Control Mix Property Tolerances	
Property	Production Tolerances
Asphalt Content (%)	JMF ± 0.3 %
Air Voids (%)	2.0 to 4.0 %
Voids in Mineral Aggregate (VMA) %	≥ 18.0%
% Passing No. 8 (2.36 mm) Sieve	JMF ± 4
% Passing No. 200 (75 µm) Sieve	JMF ± 2.0

496.7-ACCEPTANCE TESTING:

496.7.1-Acceptance Testing of HMA: Acceptance testing of HPTO is the responsibility of the Division. The acceptance sampling and testing requirements for the mixture shall be as set forth in MP 401.02.29, with the exception that the HPTO shall be monitored for conformance to the mix property requirements of Table 496.6.2.

496.7.2-Compaction: Acceptance testing for compaction shall be performed in accordance with the Lot-by-Lot method described in Section 496.7.2.1. Any patching-and-leveling and scratch courses placed prior to the placement of the HPTO shall be compacted to the satisfaction of the Engineer. When HPTO is placed in areas that require a nonuniform

thickness or is tapered to a thin edge, the method of acceptance testing shall be determined by the Engineer. Acceptance testing is not required on areas in which a full-size roller is restricted from properly compacting the mat. These areas shall be compacted to the satisfaction of the Engineer.

496.7.2.1-Lot-By-Lot Testing: Randomly located nuclear density tests will be performed in accordance with the Lot by Lot test procedure as described in MP 401.05.20. The pavement shall be divided into Lots not exceeding 1000 feet (300 meters) of paving lane. A randomly located density test shall be conducted in each Lot. The density shall be monitored for conformance to the range of 94% to 97% of the maximum density of the approved mix design. If the density is outside the range, an additional five tests shall be conducted for the Lot and the average of these five tests used to judge acceptance of the Lot in accordance with Table 496.13.3A.

496.8-WEATHER RESTRICTIONS:

HPTO shall not be placed on a wet surface or when the surface temperature of the underlying course is less than 50 °F (10 °C).

496.9-EQUIPMENT:

496.9.1-Plants: Shall meet the requirements of Sections 401.9.1.

496.9.2-Dust Collector: Shall meet the requirements of Sections 401.9.2.

496.9.3-Truck Scales: Shall meet the requirements of Sections 401.9.3.

496.9.4-Test Weights: Shall meet the requirements of Sections 401.9.4.

496.9.5-Surge and Storage Bins: During the normal daily operation of the plant, HPTO may be stored in a surge or storage bin for a maximum of 4 hours, provided the bin has received prior evaluation and acceptance through the District plant inspection. The temperature of the material at time of placement and compaction shall be sufficient to properly perform these activities.

Loading of trucks through the storage bin will only be permitted when a minimum 25 ton (23 Mg) buffer of material is being maintained or an amount as recommended by the bin manufacturer. Means shall be provided for loading the trucks directly from the mixer when the storage bin is not in operation.

496.9.6-Inspection of Equipment and Plant Operations: Shall meet the requirements of Sections 401.9.6.

496.9.7-Trucks for Transporting Mixture: Shall meet the requirements of Sections 401.9.7.

496.9.8-Laboratory: Shall meet the requirements of Sections 401.9.8.

496.9.9-Spreading Equipment: Shall meet the requirements of Sections 401.9.9.

496.9.10-Compaction Equipment: Shall meet the requirements of Sections 401.9.10.

496.9.11-Materials Transfer Vehicle: Provide and use a Material Transfer Vehicle (MTV) to place asphalt mixtures. The MTV shall include a system in the storage bin to continuously blend the asphalt mixture prior to discharge, and a system to independently deliver asphalt mixtures from the hauling equipment to the paving equipment. It shall also have a high capacity truck unloading system, capable of 600 tons per hour, that will receive asphalt mixtures from the hauling equipment, and have a minimum combined capacity, including the MTV storage bin and paver hopper, of 15 tons of asphalt mixture. Additionally, the MTV should have a discharge conveyor, with the ability to swivel and deliver the mixture to the paving spreader while allowing the MTV to operate from an adjacent lane.

496.10-PAVING OPERATIONS:

496.10.1-Cleaning and Sweeping: Shall meet the requirements of Sections 401.10.1.

496.10.2-Patching and Leveling and Scratch Courses:

496.10.2.1-Patching and Leveling: Shall meet the requirements of Sections 401.10.2.1. When patching and leveling is used, a PG 64S-22 tack coat or approved Non-Tracking Asphalt Material shall be applied to the existing pavement sections being patched in accordance with Section 496.10.3 prior to placement.

496.10.2.2-Scratch Course: Scratch course should not be used on most projects, but if it is used, it shall meet the requirements of Sections 401.10.2.2. When scratch course is used, a PG 64S-22 tack coat or NTSS-1HM shall be applied to the existing pavement in accordance with Section 496.10.3 prior to placement.

496.10.3-Spreading and Finishing: Before spreading any HPTO, a hot tack coat of PG 64S-22 or Non-Tracking Asphalt Material shall be applied to the existing surface according to Section 408. The contact surfaces of curbs, gutters, manholes, and of adjacent Portland cement concrete pavement edges shall be painted or sealed with the same tack coat material. When precipitation has occurred during the previous 24 hours, the engineer will determine if the tack coat may be applied or if the work will be delayed until the surface is completely dry. No more tack coat shall be applied than can be covered in the same day. Traffic control shall be provided to prevent vehicles from riding on surfaces upon which tack coat has been applied. The PG 64S-22 tack coat shall be applied at a rate of 0.05 – 0.12 gal/yd² (0.23 – 0.54 L/m²) and at a spraying temperature of approximately 325 °F (163 °C). Non-Tracking Asphalt Material shall be applied at a rate to produce a residual rate of 0.05 - 0.12 gal/yd² (0.23 – 0.54 L/m²) and shall be applied at a temperature of approximately 170 °F (77 °C). The spraying temperature and application rate will be adjusted by the Engineer as required to produce a uniform coating so that every part of the surface is covered, with no excess material. All uncoated or lightly coated areas shall be corrected. All areas showing an excess of asphalt binder shall be corrected by removing the excess material. The application is not acceptable if the material is streaked or ribboned.

The HPTO mixture shall meet the temperature requirements recommended by the asphalt supplier which will be referenced on the JMF. The mix temperature shall be monitored by inserting a dial type thermometer into the mix through a hole in the truck bed. The mixture shall not be placed if the temperature is below 265 °F (130 °C).

The temperature of the completed mix, when measured at the plant, shall be within the tolerance as established by the JMF. The first load, which demonstrates temperatures outside of that range shall be accepted provided that the temperature is still within the master temperature range. Any truckload of material which exceeds the master temperature range may be rejected by the Engineer. No additional loads of material shall be run out until necessary steps are taken to reestablish the temperature of the mix within the plant tolerance. When measured at the project site, the temperature of the mix shall be within the tolerance established by the JMF. The first truck load of material which demonstrates temperatures outside of that range or any trucks in transit at that time shall be accepted provided the temperature is not below 265 °F (130 °C). Any truckload of material which exceeds the JMF temperature range and/or is below 265 °F (130 °C) shall be rejected by the Engineer. The plant shall immediately be notified that no additional loads of material are to be dispatched until necessary action is taken to reestablish temperature within JMF specification limits.

The Contractor shall monitor the surface temperature at a minimum of once every hour. When the surface temperature begins dropping toward the 50 °F (10 °C) minimum temperature for placement, temperature monitoring shall increase to a minimum of once every ½ hour. Placement shall be halted when the surface temperature drops below 50 °F (10 °C).

The placement of all HPTO material at the job site shall be accomplished using a Materials Transfer Vehicle as discussed in 496.9.11.

496.10.4-Rolling Procedure: Shoulders, ramps, and similar areas shall be compacted in the same method as the mainline.

During rolling, roller wheels shall be kept moist with only enough water to avoid picking up material. Fuel oil or other petroleum products are not allowed on roller wheels or pneumatic tires. Rollers shall move at a slow but uniform speed with the drive roll or wheels nearest the paver. The sequence of rolling operations and the type of rollers used shall be at the discretion of the Contractor. A sufficient number of rollers shall be furnished to handle the output of the plant.

If rolling causes material displacement, the affected area shall be loosened at once with lutes or rakes and restored to their original grade with loose material before being re-rolled. Heavy equipment, including rollers, should not be permitted to stand on the finished surface before it has thoroughly cooled or set.

Any mixture that becomes loose and broken, mixed with dirt, contains check-cracking, or in any way defective shall be removed and replaced with fresh HPTO mixture and immediately compacted to conform to the surrounding area at the Contractor's expense.

496.10.5-Joints: The formation of all joints shall be made in such a manner as to ensure a continuous bond between the courses and obtain the required density. All contact surfaces shall be given a tack coat of asphalt binder prior to placing any fresh mixture against the joint.

The longitudinal joint in any layer shall offset that in the layer immediately below by approximately six inches; however, the joint in the top layer shall be at the centerline of the pavement if the roadway comprises two lanes of the width, or at lane lines if the roadway is

more than two lanes in width. The transverse joint in any layer shall offset that in the layer immediately below by approximately six feet.

All transverse joints between existing and new pavement shall be "heeled-in" to the existing surface at the beginning and at the end of the project and at all other locations where the new pavement terminates against an existing pavement. Transverse joints between one day's production and the next shall be carefully constructed and shall be formed by cutting back into the existing section to expose the full depth of the course. All joints shall be squared up to the full vertical depth of the course to be placed, and a tack coat of asphalt material shall be applied. Joints adjacent to curbs, gutters, or adjoining pavement shall be formed by transporting back sufficient hot material to fill any space left uncovered by the paver.

Longitudinal joints which are irregular, damaged, un-compacted, or otherwise defective shall be cut back to expose a clean, sound surface for the full depth of the course. The longitudinal joint between adjacent mats shall be set up to a sufficient height to receive the full compactive effort from the rollers and shall be tacked prior to placing adjacent material. Transverse joints shall be checked for smoothness with a ten foot straight edge provided by the Contractor. All surface irregularities shall be corrected prior to proceeding with paving operations.

496.11-PROTECTION OF PAVEMENT AND TRAFFIC CONTROL: Shall meet the requirements of Sections 401.11.

496.12-METHOD OF MEASUREMENT:

HPTO will be measured by the ton (Mg), or square yard (square meter). If the project is to be paid by the ton, the quantity will be determined by the Contractor from the total weight slips for each vehicle load weighed upon an approved standard scale or from digital printout slips from an automatic batching plant, and certified by the Contractor as correct. If the project is to be paid by the square yard, the quantity will be determined by the Plan Quantity as provided for in the proposal unless otherwise directed by the Engineer.

Any patching or leveling mixture placed on a subbase or base course constructed in the same Contract with the HPTO item shall be at the expense of the Contractor. No additional compensation will be allowed for the material or any work incidental to its placement.

496.13-BASIS OF PAYMENT:

The quantities determined as provided above, will be paid for at the contract unit price for the items listed below, which prices and payment shall be full compensation for furnishing all the materials and doing all the work herein prescribed in a workmanlike and acceptable manner, including all labor, tools, equipment, field laboratory, supplies, and incidentals necessary to complete the work.

When a Lot of HMA pavement does not meet the density requirements of 496.7.2, the price shall be adjusted as follows:

Formula 1: Projects requiring only mat density testing:

$$\text{Lot Price Adjustment (Mat only)} = (\text{unit price}) \times (\text{Lot quantity}) \times (\text{mat density price adjustment \% from Table 496.13.3A})$$

Formula 2: Projects requiring both mat and joint density testing:

$$\text{Lot Price Adjustment (Mat + Joint)} = (\text{unit price}) \times (\text{Lot quantity}) \times [(\text{mat density price adjustment \% from Table 496.13.3A}) + (\text{joint density price adjustment \% from Table 496.13.3B})]$$

TABLE 496.13.3A

Adjustment of Contract Price for Pavement Mat Density Not Within Tolerance	
Percent of Mat Density	Percent of Contract Price To Be Paid
Greater than 97 %	Note 1
96% to 97%	102
94 % to 96 %	100
93 %	98
92 %	96
91 %	92
90 %	88
Less Than 90 %	Note 2

Note 1: Mat density slightly above 97% is normally only a problem if it leads to asphalt flushing on the surface of the mat or rutting due to an unstable mix. The Division will make a special evaluation of the material and determine the appropriate action.

Note 2: For price adjustments on mat densities less than 90%, the percent of Contract Bid Price will be decreased by 10% per percentage of mat density less than 90%, unless a special evaluation performed by the Division determines a more appropriate action.

TABLE 496.13.3B

Adjustment of Contract Price For Pavement Joint Density Not Within Tolerance	
Percent of Joint Density	Percent Adjustment
Greater than 97 %	Note 3
96 % to 97 %	+2.0%
94% to 95%	+1.0
92% to 93% ^{Note 4}	0%
91 % ^{Note 6}	-1.0%
90 % ^{Notes 5 & 6}	-10.0%

Note 3: Density greater than 97% is normally only a problem if it leads to asphalt flushing on the surface of the mat or rutting due to an unstable mix. The Division will make a special evaluation of the material and determine the appropriate action.

Note 4: If the longitudinal joint density is determined to be less than 94% on at least 20% of the total project Lots, then the Contractor shall be required to seal the joint a minimum of 3” on each side of the joint with a heated PG 64S-22 binder (or approved equivalent) on the entire project at no additional cost to the Division

Note 5: Density values less than the minimum specified 92% will be more susceptible to accelerated deterioration of both the joint and the surrounding pavement. Less than 90% will require the Division to make a special evaluation of the material and determine the appropriate action.

Note 6: Note 6: Any joint densities determined to be below 92% the Contractor shall be required to seal the joint a minimum of 3” on each side of the joint on the entire project with a heated PG 64S-22 binder (or approved equivalent) at no additional cost to the Division

The conditioning, cleaning, and sweeping of the existing base or underlying surface shall be considered as part of the construction of the appropriate items listed in 496.14, and no additional compensation will be allowed for "Cleaning and Sweeping".

There will be no additional compensation for tack coat material used for minor (spot) areas to be patched and leveled; the cost of this tack coat material will be included in the unit bid price for Item 401003.

There will be no additional compensation for Interim Pavement Markings.

496.14-PAY ITEMS:

ITEM	DESCRIPTION	UNIT
496001-001	Asphalt High Performance Thin Overlay, "aggregate type"	Ton (MG)
496001-003	Asphalt High Performance Thin Overlay,	Square Yard (Meter)
496002-001	Performance Graded Binder for Tack Coat, Type 64S-22	Gallon (Liter)

"aggregate type" shall be either stone and gravel or slag.

WEST VIRGINIA DEPARTMENT OF TRANSPORTATION

DIVISION OF HIGHWAYS

SPECIAL PROVISION

FOR

STATEWIDE ASPHALT MATERIALS, DELIVERY

& LABOR BY VENDOR BY COUNTY

CONTRACT 6621C044, ATTACHMENT H

SECTION 498

ULTRA-THIN ASPHALT OVERLAY

498.1 – DESCRIPTION:

This Special Provision covers the materials, equipment, construction, and application procedures for placing Ultra-Thin Asphalt Overlays on existing paved surfaces. Ultra-Thin, as described in this Special Provision shall be defined as a single lift ranging from 5/8" (70 psy) to 3/4" (85 psy).

498.2 – MATERIALS:

The mixture components of the asphalt mixture shall conform to the following requirements:

498.2.1 – Tack Coat: The Tack Coat shall conform to the requirements of Section 408.2.

498.2.2 - Performance Graded Binders: The PG Binders shall conform to Section 705.5. The binder grade shall be noted on the typical section of the plans.

498.2.3 - Fine Aggregate: The fine aggregate used shall meet the requirements of ASTM D1073, except that the gradation requirements will be waived. In addition, aggregates used for surface courses on projects with an ADT greater than 3000 shall be from an approved source identified as having polish-resistant aggregates and considered potential skid-resistant aggregate sources.

498.2.3.1 – Sand Equivalency - (ASTM D2419): The Sand Equivalency value of the fine aggregate shall be 60 minimum.

498.2.3.2 – Soundness - (MP 700.00.22): When subjected to five cycles of the Sodium Sulfate test, the weighted percentage of loss shall not exceed twelve (12%).

498.2.3.3 – Fine Aggregate Angularity - (AASHTO T304): When using Method A, the Fine Aggregate blend shall have a Minimum uncompact void content of 43%.

498.2.4 – Coarse Aggregate: If coarse aggregate is used, it shall meet the requirements of Sections 703.1 through 703.3, with the exception that the total shale, coal and other lightweight deleterious material and friable particles shall not exceed 3%. In addition, aggregates used for surface courses on projects with an ADT greater than 3000 shall be from an approved source identified as having polish-resistant aggregates and considered potential skid-resistant aggregate sources. No more than 50% of the coarse aggregate shall be Dolomite.

498.3 – ASPHALT MIXTURE:

498.3.1 – Job Mix Formula: A Job Mix Formula (JMF) shall be developed in accordance with MP 401.02.22 procedurally, but the asphalt mixture shall conform to the requirements detailed in the following Tables. The asphalt mixture shall be identified as Wearing- III – Heavy on the T-400 Form. The asphalt mixture shall be produced at a WVDOH approved plant.

Table 498.3.1.1 – Ultra-Thin Asphalt Overlay Mixture Marshall Design Requirements

Test Property	Design Criteria (Marshall)
Compactive Effort (# of blows – each end of specimen)	75 Blows
Percent Air Voids	4.0 %
Percent VMA	17.0 % - Minimum
Percent VFA	73 – 80
Stability (Newtons)	10,000 - Minimum
Flow (0.25 mm)	7 – 16
Fines to Asphalt Ratio	0.5 – 1.0

Table 498.3.1.2 – Ultra-Thin Asphalt Overlay Mixture Design Gradation Requirements

Sieve Size	Total Percent Passing by Weight
1 / 2 Inch	100
3 / 8 Inch	96 – 100
No. 4	70 – 95
No. 8	40 – 65
No. 16	20 – 45
No. 30	15 – 30
No. 50	8 – 20
No. 200	3.0 – 8.0

498.4 – CONSTRUCTION:

498.4.1 – Tack Coat: The Tack Coat shall be applied uniformly, completely covering the entire prepared surface, at an application rate of 0.03 – 0.05 gallon/square yard undiluted or 0.06 – 0.10 gallon/square yard diluted, regardless of existing surface. All requirements of Sections 408.3 through 408.10 shall be followed.

498.4.2 – Asphalt Overlay Placement: The asphalt overlay shall be produced, placed and compacted in accordance with Sections 401.9 and 401.10. It shall be placed at the application rate stated in the plans, which shall be within the rates noted in Section 498.1. Application rate shall be checked at a maximum interval of 2500 feet.

Due to the rapid cooling rate of the asphalt mixture at this application rate range, the weather restrictions as stated in Section 401.8 shall be strictly enforced. The paving operation shall be paced as to not outrun the rollers. The following number of rollers shall be required:

Average Laydown Rate (Tons / Hour)	Compaction Rollers Required	Finish Rollers Required
Less than 75	1	1
75 - 150	2	1

498.5 – TESTING:

The standard test methods as outlined in Section 401.5.1 shall be followed.

498.5.1 – Contractor’s Quality Control: Contractor shall follow the requirements of Section 401.6 for Quality Control Testing except that samples for determination of mix properties shall be obtained at intervals of 250 tons production.. The tolerances shown in Table 498.5.1.1 below shall be used for production, and be applied for basis of payment as per Section 498.7.

Table 498.5.1.1

Ultra-Thin Asphalt Overlay Production Tolerances for Quality Control and Acceptance

Parameter	Range from JMF
Air Voids ¹	± 1.5
Binder Content ²	± 0.40
% Passing ½” Sieve	0
% Passing 3/8” Sieve	± 2.0
% Passing # 8 Sieve	± 5.0
% Passing # 30 Sieve	± 4.0
% Passing # 200 Sieve	± 1.5

1 The limits for air voids shall apply to Quality Control testing only

2 The asphalt binder content shall be determined by the ignition oven method.

498.5.2 – Acceptance Testing: Acceptance testing is the responsibility of the Division.

498.5.3 – Compaction Testing: Since the nuclear gauge does not accurately read densities at this specified lift thickness and the asphalt will cool rapidly, the compaction shall consist of making six (6) roller passes. A roller pass is one complete coverage over the material. The compaction needs to be completed before the mat temperature reaches 175° F.

498.5.4 – Quality Control and Verification Testing: The Contractor shall designate a person to monitor and document the number of passes and the mat temperature through the duration of the Project. This person shall be certified as WVDOH Asphalt Field and Compaction Technician.

498.6 – METHOD OF MEASUREMENT:

498.6.1 – Tack Coat: The tack coat shall be measured in accordance to Section 408.12.

498.6.2 – Asphalt Overlay: Depending on the items specified in Section 498.8, the asphalt overlay shall be either measured by the square yard as placed or shall be measured in accordance to Section 401.12.

498.7 – BASIS OF PAYMENT:

498.7.1 – Tack Coat: The tack coat shall be paid in accordance to Section 408.13.

498.7.2 – Ultrathin Asphalt Overlay: The completed work shall be paid for based on the measurements obtained as per Section 498.6.2 and paid at the contract unit price per the items shown in Section 498.8. Based on the results of testing performed as per 498.5, the following price adjustment schedule will be used when appropriate and applied accordingly to representative material:

- (i) One percent reduction in the bid price per square yard for each one-tenth percent the asphalt content is out of tolerance.
- (ii) One-quarter percent price adjustment in the bid price per square yard for each one percent that the aggregate gradation is out of the job mix range on each sieve
- (iii) One and a half percent reduction in the bid price per square yard for application rate dropping below the plan rate by more than 2 lb/sq yd. Reduction shall apply to each increment of 1lb/sq yd thereafter. If the application rate drops below the plan rate by more than 5 lb/sq yd, the material will not be accepted and measures will need to be taken by the contractor to correct for such deficiency

Price adjustments under 1, 2, and 3 above shall apply concurrently; however, price adjustment will not apply in the event the material is rejected. The disposition of rejected material will be subject to the approval of the Engineer

498.8 – PAY ITEMS:

ITEM	DESCRIPTION	UNIT
498000-001	Ultrathin Asphalt Overlay	Squary Yard (SY)
498001-001	Ultrathin Asphalt Overlay	Ton (TN)

Exhibit 1 - Shoulder Reconstruction Detail

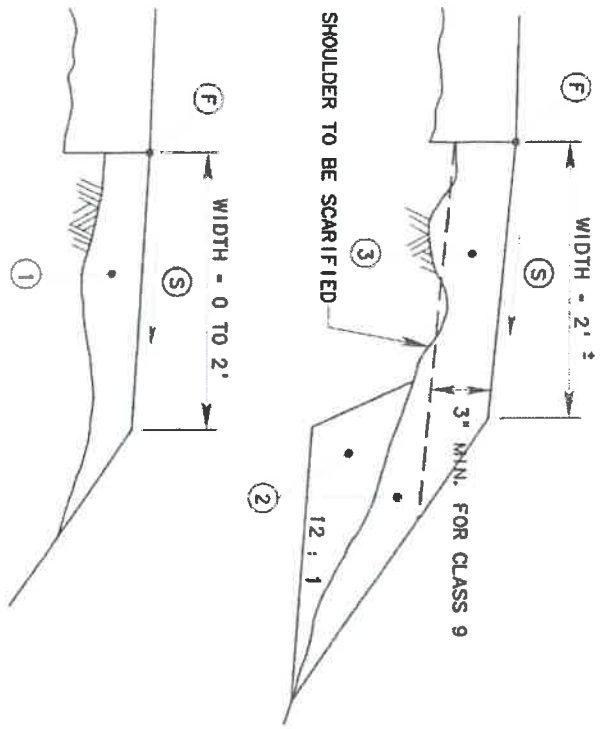
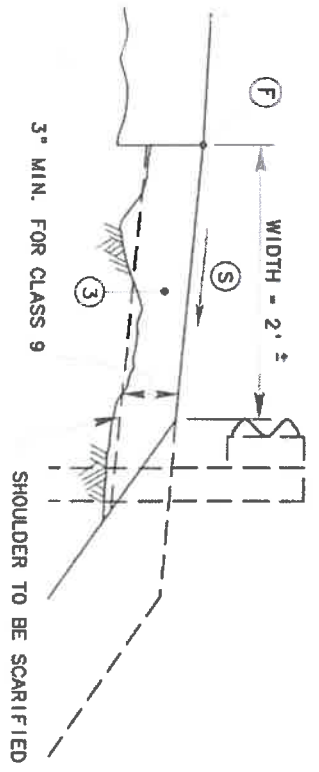

NORMAL SECTIONS

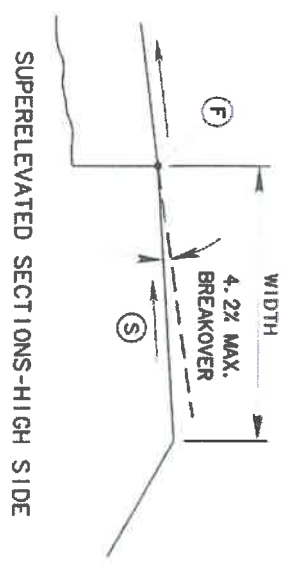

LEGEND

- ① ITEM 401001 - , HOT-MIX ASPHALT BASE COURSE, TYPE
- ② ITEM 211008-000, ROCK BORROW EXCAVATION
The intent of this item is to provide proper foundation for the shoulder while restoring the original shoulder width reduced by erosion. Additional material, as directed by the Engineer, may be required by recent erosion and will be paid for as 211008-000. Excavation of benches for placing, 211008-000 will be included in 211008-000.
- ③ ITEM 307005-001, AGGREGATE BASE COURSE, CLASS 10
This item includes any necessary removal of existing shoulder material to a minimum of 3" below the finished pavement elevation when Class 9 aggregate is specified. Material removed shall be reused within the project limits or wasted as directed by the Engineer. Scarifying shall be in accordance with Section 308.3.1 of the Specifications.
- ④ FINISHED PAVEMENT ELEVATION
- ⑤ SHOULDER SLOPE
- ⑥ Normal Sections : 6 %.
- ⑦ Super-elevated : Match rate of super-elevation or reduce as shown above
- ⑧ Minimum slope to be 3/4" per foot, on low side of super-elevation.
- ⑨ Paved Shoulders : 4 % or super-elevated.

THE WEST VIRGINIA DEPARTMENT OF TRANSPORTATION DIVISION OF HIGHWAYS
SHOULDER RECONSTRUCTION

Public Roads Div.,	State Dist. No.	State Project No.	Federal Project No.	County
W. V.				

Exhibit 2 - Restoring Shoulder for Guardrail Detail

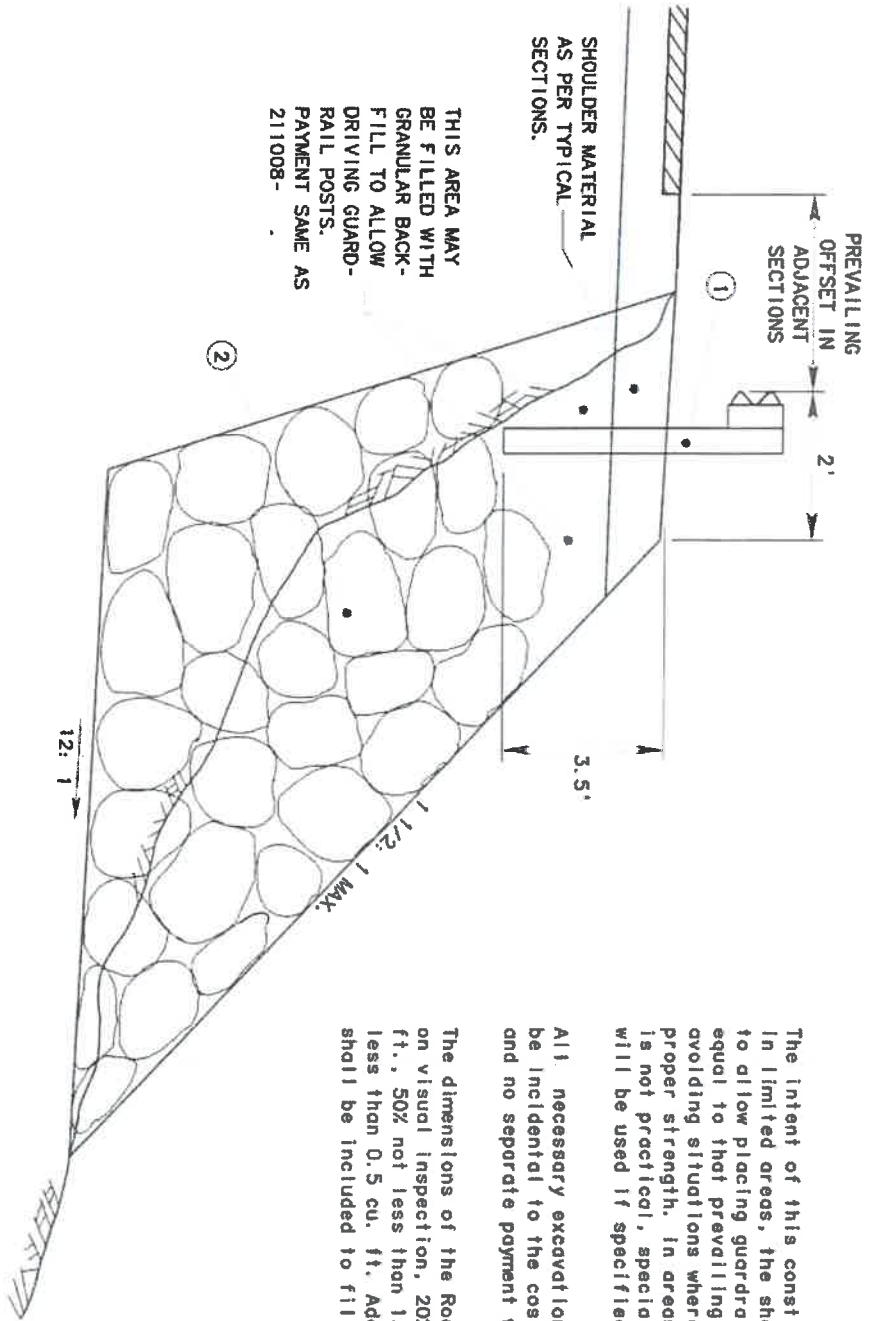

- ① ITEM 607001-001, TYPE 1 GUARDRAIL, CLASS (AS SHOWN ON PLANS)
- ② ITEM 211008-000, ROCK BORROW EXCAVATION

The intent of this construction is to restore, in limited areas, the shoulder width sufficiently to allow placing guardrail at an offset nearly equal to that prevailing in adjacent sections avoiding situations where posts would not provide proper strength. In areas where such construction is not practical, special designs such as piling will be used if specified in the plans.

All necessary excavation of the fill bench will be incidental to the cost of Items 211008-000, and no separate payment will be made.

The dimensions of the Rock Borrow shall be, based on visual inspection, 20% not less than 1.5 cu. ft., 50% not less than 1.0 cu. ft. and 30% not less than 0.5 cu. ft. Adequate rock fragments shall be included to fill the rock voids.

THE WEST VIRGINIA DEPARTMENT OF TRANSPORTATION DIVISION OF HIGHWAYS RESTORING SHOULDERS FOR GUARDRAIL

Public Roads Div.	State Dist. No.	State Project No.	Federal Project No.	County
W. V.				

Exhibit 3 - Repaving Pipe Trenches in Paved Shoulder Detail

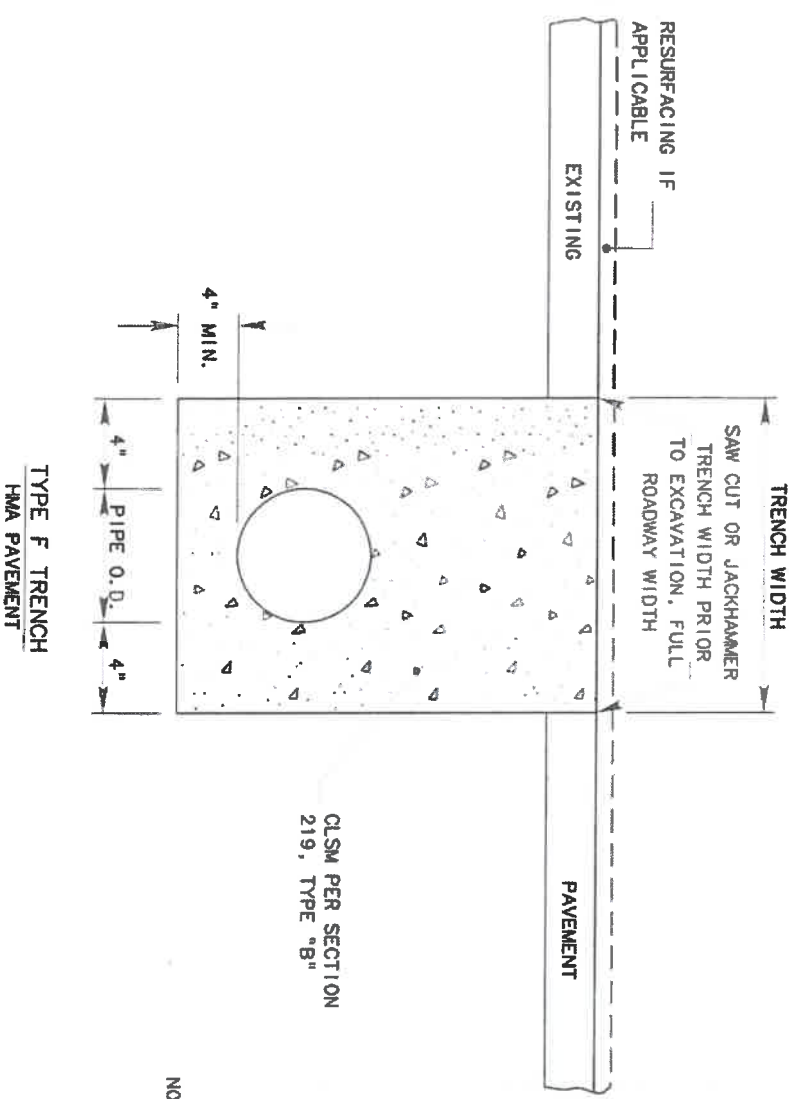

CLSM PER SECTION 219, TYPE "B"

TYPE F TRENCH
HMA PAVEMENT

NOTE:

IF TYPE F TRENCH IS USED WHERE THERE IS NO EXISTING OR PROPOSED INLET, THE CLSM SHALL BE POURED FULL DEPTH 2' PAST EACH E.P. THE PIPE SHALL BE ENCASED IN 4" OF CLSM AN ADDITIONAL 10' MAX. BEYOND E.P. IF THERE IS AN EXISTING OR PROPOSED INLET THE CLSM SHALL BE POURED FULL DEPTH TO THE INLET.

WHEN NO OVERLAY IS SPECIFIED THE CONTROLLED LOW-STRENGTH MATERIAL (CLSM) SHALL BE A MIN. OF 2000 psi FOR DDH PIPES ONLY. NOT TO BE USED FOR UTILITY PIPES.

REPAVING PIPE TRENCHES IN PAVED SHOULDER

THE WEST VIRGINIA DEPARTMENT OF TRANSPORTATION DIVISION OF HIGHWAYS

Public Roads Div.	State No.	State Project No.	Federal Project No.	County
W. V.				

Exhibit 4 - Resurfacing Heel-In Detail

TEMPORARY WEDGES AT HEEL-INS

THE CONTRACTOR MAY ELECT TO CUT THE REQUIRED HEEL-INS SUCH THAT TRAFFIC MUST BE MAINTAINED OVER THE HEEL-IN AREAS PRIOR TO THE PLACEMENT OF THE PERMANENT HMA MATERIAL. IF THE CONTRACTOR CHOOSES THIS METHOD AS AN ALTERNATE TO CUTTING THE HEEL-INS AND BACKFILLING WITH PERMANENT HMA PRIOR TO RESTORING TRAFFIC, IT SHALL BE THE CONTRACTORS RESPONSIBILITY TO PLACE TEMPORARY HMA WEDGES 10 FEET IN LENGTH FOR EACH 1 INCH OF EXISTING SURFACE REMOVED AT THE VERTICAL FACE, FOR EXAMPLE, IF 2 INCHES ARE REMOVED AT THE VERTICAL FACE, THE TEMPORARY HMA WEDGE SHALL BE 20 FEET IN LENGTH. THE WEDGES SHALL BE CONSTRUCTED OF ITEM 401001-011, TYPE 19, PLACED AND COMPACTED IN ACCORDANCE WITH SECTION 401.14. THESE TEMPORARY WEDGES SHALL BE REMOVED IMMEDIATELY PRIOR TO PLACING THE PERMANENT SURFACE. THE COST OF THIS WORK WILL BE INCLUDED IN VARIOUS PAVEMENT ITEMS.

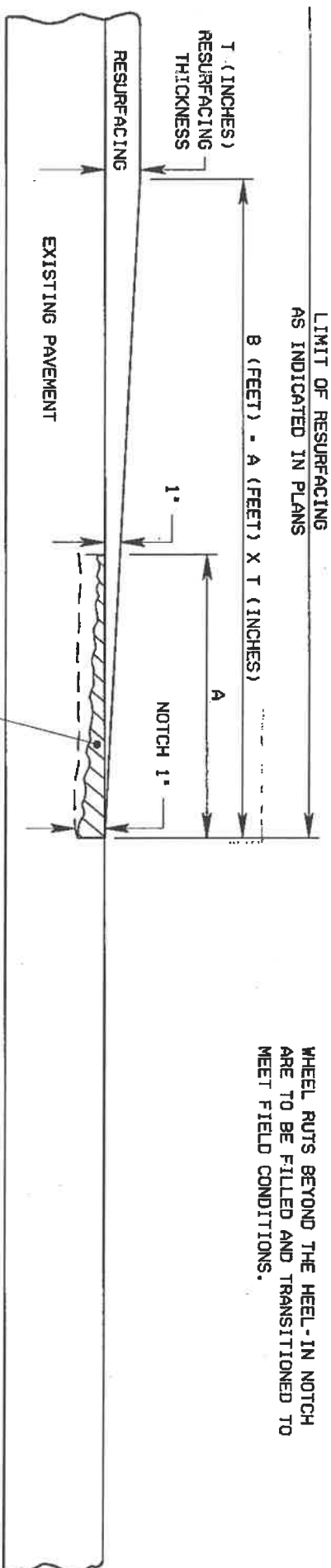

WHEEL RUTS BEYOND THE HEEL-IN NOTCH ARE TO BE FILLED AND TRANSITIONED TO MEET FIELD CONDITIONS.

AREA OF HEEL-IN TO BE NOTCHED INTO EXISTING CONCRETE OR HMA PAVEMENT.

1. PAYMENT FOR HEEL-IN TO BE INCLUDED IN VARIOUS PAY ITEMS OF THIS PROJECT
2. THIS DETAIL TO BE USED AT TERMINI OF RESURFACING PROJECTS AND AT ALL TERMINI FOR SKIP RESURFACING PROJECTS.
3. THIS DETAIL TO BE USED AT LOCATIONS FOR HEEL-IN INTERSECTIONS OF THIS PROJECT.
4. THE FOLLOWING NUMBER(S) OF HEEL-INS FOR THE MAINLINE ON THIS PROJECT SHALL BE:
PERPENDICULAR
SKEWED AT

POSTED SPEED LIMIT	A
25 MPH	12'
30 TO 35 MPH	14'
40 TO 45 MPH	16'
50 TO 55 MPH	18'
60 TO 70 MPH	25'

THE WEST VIRGINIA DEPARTMENT OF TRANSPORTATION DIVISION OF HIGHWAYS
RESURFACING HEEL-IN DETAIL

PUBLIC ROADS DIV.	STATE DIST. NO.	STATE PROJECT NO.	FEDERAL PROJECT NO.	COUNTY
W. V.				

Exhibit 5 - Base Failure Repair Detail

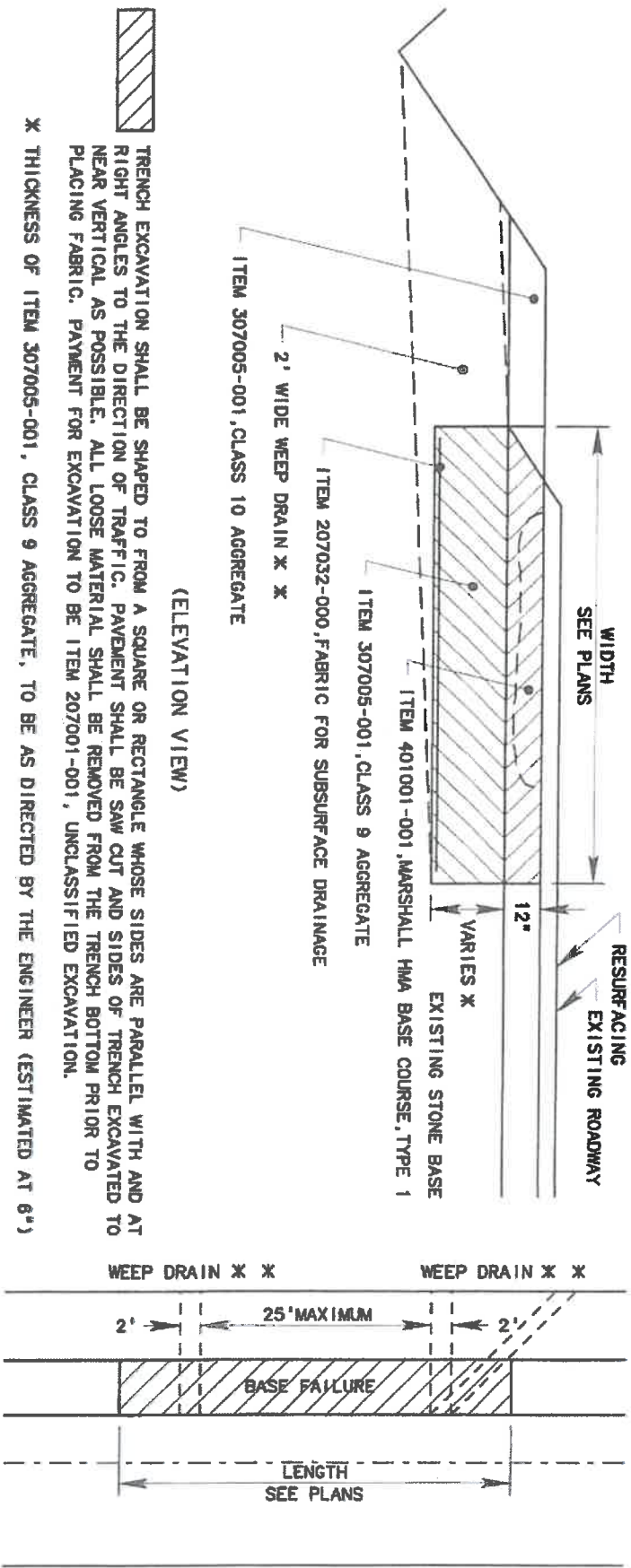

TRENCH EXCAVATION SHALL BE SHAPED TO FORM A SQUARE OR RECTANGLE WHOSE SIDES ARE PARALLEL WITH AND AT RIGHT ANGLES TO THE DIRECTION OF TRAFFIC. PAVEMENT SHALL BE SAW CUT AND SIDES OF TRENCH EXCAVATED TO NEAR VERTICAL AS POSSIBLE. ALL LOOSE MATERIAL SHALL BE REMOVED FROM THE TRENCH BOTTOM PRIOR TO PLACING FABRIC. PAYMENT FOR EXCAVATION TO BE ITEM 207001-001, UNCLASSIFIED EXCAVATION.

- X THICKNESS OF ITEM 307005-001, CLASS 9 AGGREGATE, TO BE AS DIRECTED BY THE ENGINEER (ESTIMATED AT 6")
- X X WEEP DRAINS SHALL BE LOCATED AT ALL LOW POINTS IN TRENCH. MAXIMUM SPACING BETWEEN WEEP DRAINS SHALL BE TWENTY FIVE (25) FEET. DRAINS MAY BE SKEWED WHERE NECESSARY TO MAINTAIN SLOPE AWAY FROM THE TRENCH AREA. PAYMENT FOR WEEP DRAINS TO BE INCLUDED IN ITEM 307005-001, CLASS 9 AGGREGATE BASE COURSE.

THE WEST VIRGINIA DEPARTMENT OF TRANSPORTATION DIVISION OF HIGHWAYS
BASE FAILURE REPAIR DETAIL

Public Works Div.	State Dist. No.	State Project No.	Federal Project No.	County
W. V.				

Exhibit 6 - Edge Failure Repair Detail

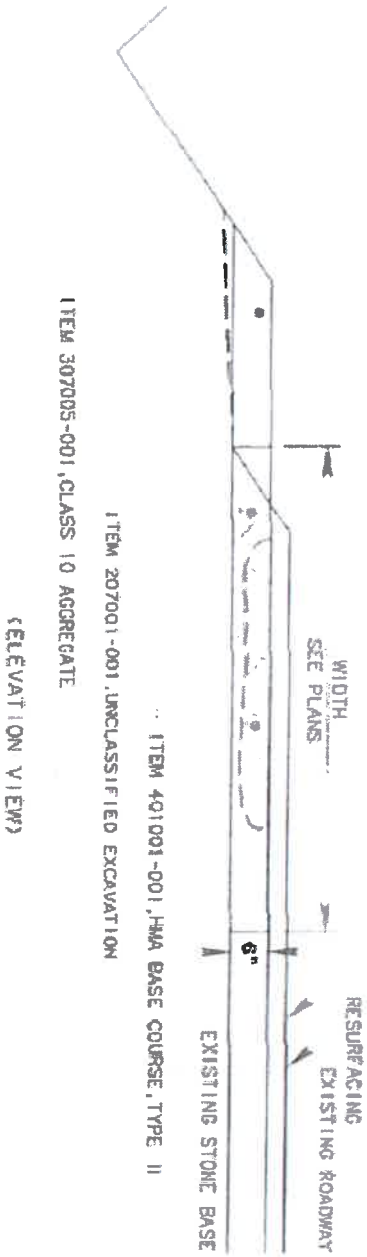

TRENCH EXCAVATION SHALL BE SHAPED TO FORM A SQUARE OR RECTANGLE WHOSE SIDES ARE PARALLEL WITH AND AT RIGHT ANGLES TO THE DIRECTION OF TRAFFIC. PAVEMENT SHALL BE SAW CUT AND SIDES OF TRENCH EXCAVATED TO NEAR VERTICAL AS POSSIBLE. ALL LOOSE MATERIAL SHALL BE REMOVED FROM THE TRENCH BOTTOM PRIOR TO PLACING HMA.

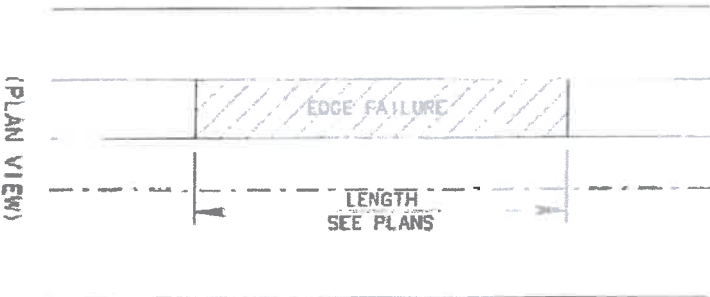

THE WEST VIRGINIA DEPARTMENT OF TRANSPORTATION DIVISION OF HIGHWAYS EDGE FAILURE REPAIR DETAIL

Public Works Div.	State Project No.	Federal Project No.	County
W. V.			

Exhibit 7 - Pothole Repair Detail

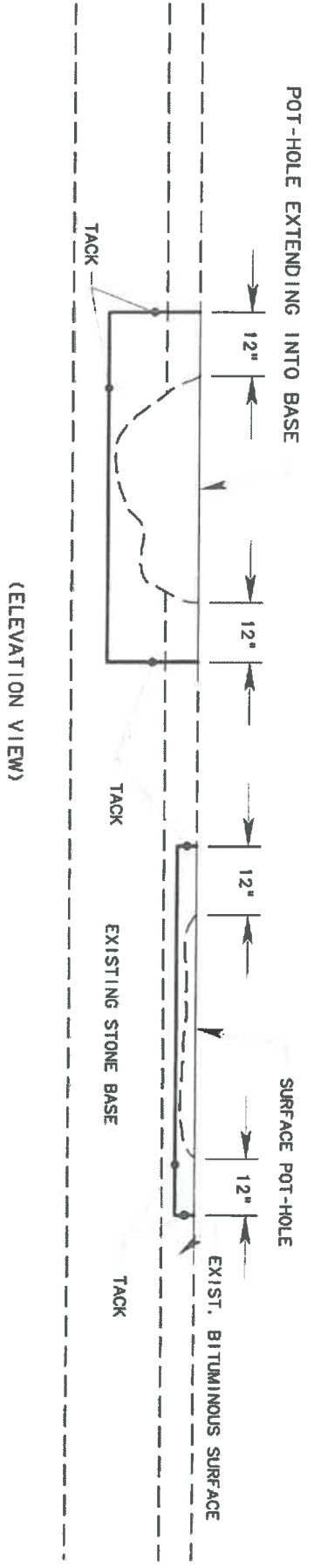

THE SIDES AND BOTTOMS MUST BE CLEANED AFTER THE HOLE IS SHAPED TO FROM A SQUARE OR RECTANGLE WHOSE SIDES ARE PARALLEL OR AT RIGHT ANGLES TO THE DIRECTION OF TRAFFIC WITH THE EDGES NEAT AND AS NEARLY VERTICAL AS POSSIBLE.

THE EXISTING BASE WILL BE REPLACED WITH HOT-LAID ASPHALT.

THE REMAINING SURFACE POT-HOLE WILL BE FILLED WITH HOT-LAID ASPHALT BASE COURSE TYPE MEETING REQUIREMENTS OF SECTION 401 OF THE SPECS. ENOUGH MATERIAL MUST BE USED TO BRING THE SURFACE OF REPAIR ABOUT 1/4" ABOVE THE LEVEL OF THE ORIGINAL PAVEMENT TO ALLOW FOR FURTHER COMPACTION BY TRAFFIC AND/OR RESURFACING.

THE WEST VIRGINIA DEPARTMENT OF TRANSPORTATION DIVISION OF HIGHWAYS
POT - HOLE REPAIR DETAIL

Public Roads Div.	State Dist. No.	State Project No.	Federal Project No.	County
W. V.				

Exhibit 8 - Rumble Strip Special Detail

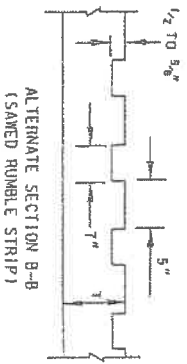

RUMBLE STRIP FOR HOT MIX ASPHALT SHOULDERS

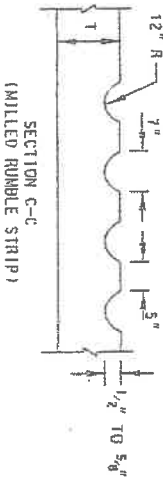
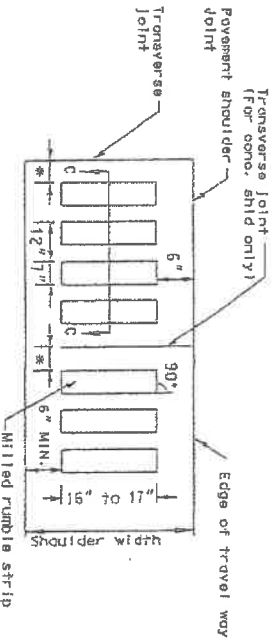

MILLED RUMBLE STRIP FOR PORTLAND CEMENT AND HOT MIX ASPHALT SHOULDERS

NOTES:
RUMBLE STRIP PLACEMENT WILL BE CONTIGUOUS OR HOT-MIX ASPHALT SHOULDERS.
EXCEPT AS NOTED BELOW.

RUMBLE STRIPS SHALL NOT BE PLACED AT THE FOLLOWING AREAS FOR HIGHWAY PROJECTS, ONLY ON SHOULDERS OF NARROW CLEARING LINES THAT ARE 5' OR LESS IN WIDTH, RIGHT OF TRAFFIC FLOW IN THE SHOULDER TRANSITION AREA, RIGHT OF TRAFFIC FLOW, BETWEEN A FULL PAVED SHOULDER WIDTH OF 10' AND NARROW GRADE WIDTH OF 4'.

RUMBLE STRIP WIDTH IS TO BE 2', EXCEPT MILLED RUMBLE STRIP WHICH WILL BE 16"-17".
RUMBLE STRIPS MAY BE SAWED OR MILLED UNLESS OTHERWISE INDICATED. THE TOP OF THE RUMBLE STRIPS WILL BE NO HIGHER THAN THE TOP SURFACE OF THE PAVEMENT OR FALTY OR DISCONTINUITY INSTALLED RUMBLE STRIPS WILL BE CONNECTED TO THE CONTRACTOR AT HIS EXPENSE.

MILL/SAW SHOULDER RUMBLE STRIPS AS INDICATED BY USING A MACHINE CAPABLE OF PROVIDING A SMOOTH CUT WITHOUT TEARING OR SHAGGING, AND PROVIDING RUMBLE STRIPS AS INDICATED. EQUIP MACHINE WITH GUIDES TO PROVIDE UNIFORMITY AND CONSISTENCY IN ALIGNMENT OF EACH CUT WITH RESPECT TO ROADWAY. MILL SHOULDER RUMBLE STRIPS TO HAVE FRESH DIMENSIONS WITH TOLERANCES SPECIFIED. MILL SHOULDER RUMBLE STRIPS ON NEW CONCRETE SHOULDERS AFTER CONCRETE ACQUISITION OF CURING PERIOD. BE REMOVED, VERIFIED AND CHECKED AFTER CONCRETE ACQUISITION OF CURING PERIOD. SANITATION PLAN TO THE ENGINEER FOR APPROVAL. AT END OF EACH WORKING DAY, MOVE ALL EQUIPMENT TO A LOCATION AS DIRECTED WHERE IT PRESENTS NO HAZARD TO ROADWAY TRAFFIC. REMOVE AND DISPOSE OF MILLED MATERIAL IN CONFORMANCE WITH APPLICABLE STATE REGULATIONS. REMOVE DEBRIS FROM AREAS DISTURBED BY MILLING OPERATION BEFORE OPENING ROADWAY TO TRAFFIC.

RUMBLE STRIPS IN PAVED SHOULDERS:

RUMBLE STRIPS SHALL BE MILLED OR SAWED TYPE PLACED IN SHOULDERS UNDER THE FOLLOWING CONDITIONS, IN ACCORDANCE WITH THIS SPECIAL DETAIL SHEET:
- TYPICAL SHOULDER WIDTH IS 8' OR MORE;
- MEDIUM SHOULDER ON DIVIDED HIGHWAYS; IF SHOULDER WIDTH IS 3' OR GREATER;
- SHOULDER ADJACENT TO ONE WAY RAMP WHICH CONNECT TO ARTERIAL HIGHWAYS, IF TYPICAL SHOULDER IS 3' OR GREATER.

THE WEST VIRGINIA DEPARTMENT OF TRANSPORTATION DIVISION OF HIGHWAYS
RUMBLE STRIP SPECIAL DETAIL

CONTRACTOR LICENSE

Authorized by the

West Virginia Contractor Licensing Board

Number:

WV001162

Classification:

GENERAL ENGINEERING
RESIDENTIAL

GREENBRIER EXCAVATING & PAVING INC
DBA GREENBRIER EXCAVATING & PAVING INC
PO BOX 277
RONCEVERTE, WV 24970-0277

Date Issued

Expiration Date

AUGUST 14, 2020

AUGUST 14, 2021

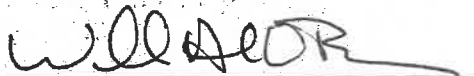

Authorized Company Signature



Chair, West Virginia Contractor
Licensing Board

**WEST VIRGINIA
CONTRACTOR
LICENSING
BOARD**

This license, or a copy thereof, must be posted in a conspicuous place at every construction site where work is being performed. This license number must appear in all advertisements, on all bid submissions and on all fully executed and binding contracts. This license cannot be assigned or transferred by licensee. Issued under provisions of West Virginia Code, Chapter 21, Article 11.



CERTIFICATE OF LIABILITY INSURANCE

DATE (MM/DD/YYYY)
02/03/2021

THIS CERTIFICATE IS ISSUED AS A MATTER OF INFORMATION ONLY AND CONFERS NO RIGHTS UPON THE CERTIFICATE HOLDER. THIS CERTIFICATE DOES NOT AFFIRMATIVELY OR NEGATIVELY AMEND, EXTEND OR ALTER THE COVERAGE AFFORDED BY THE POLICIES BELOW. THIS CERTIFICATE OF INSURANCE DOES NOT CONSTITUTE A CONTRACT BETWEEN THE ISSUING INSURER(S), AUTHORIZED REPRESENTATIVE OR PRODUCER, AND THE CERTIFICATE HOLDER.

IMPORTANT: If the certificate holder is an ADDITIONAL INSURED, the policy(ies) must be endorsed. If SUBROGATION IS WAIVED, subject to the terms and conditions of the policy, certain policies may require an endorsement. A statement on this certificate does not confer rights to the certificate holder in lieu of such endorsement(s).

PRODUCER WEST VIRGINIA INSURANCE AGENCY 151 FEAMSTER RD LEWISBURG, WV 24901	CONTACT NAME: BLAINE PHILLIPS PHONE (A/C, No, Ext): 304-645-4565 E-MAIL ADDRESS: blaine@wvins.com	FAX (A/C, No):
	INSURER(S) AFFORDING COVERAGE	
INSURER A : ERIE INSURANCE PROPERTY & CASUALTY CO		
INSURER B :		
INSURER C :		
INSURER D :		
INSURER E :		
INSURER F :		

COVERAGES **CERTIFICATE NUMBER:** **REVISION NUMBER:**

THIS IS TO CERTIFY THAT THE POLICIES OF INSURANCE LISTED BELOW HAVE BEEN ISSUED TO THE INSURED NAMED ABOVE FOR THE POLICY PERIOD INDICATED. NOTWITHSTANDING ANY REQUIREMENT, TERM OR CONDITION OF ANY CONTRACT OR OTHER DOCUMENT WITH RESPECT TO WHICH THIS CERTIFICATE MAY BE ISSUED OR MAY PERTAIN, THE INSURANCE AFFORDED BY THE POLICIES DESCRIBED HEREIN IS SUBJECT TO ALL THE TERMS, EXCLUSIONS AND CONDITIONS OF SUCH POLICIES. LIMITS SHOWN MAY HAVE BEEN REDUCED BY PAID CLAIMS.

INSR LTR	TYPE OF INSURANCE	ADDL INSD	SUBR WVD	POLICY NUMBER	POLICY EFF (MM/DD/YYYY)	POLICY EXP (MM/DD/YYYY)	LIMITS	
A	<input checked="" type="checkbox"/> COMMERCIAL GENERAL LIABILITY			Q45-7450012	09/28/2020	09/28/2021	EACH OCCURRENCE	\$ 1,000,000
	<input type="checkbox"/> CLAIMS-MADE <input checked="" type="checkbox"/> OCCUR						DAMAGE TO RENTED PREMISES (Ea occurrence)	\$ 1,000,000
							MED EXP (Any one person)	\$ 5,000
							PERSONAL & ADV INJURY	\$ 1,000,000
							GENERAL AGGREGATE	\$ 2,000,000
							PRODUCTS - COMP/OP AGG	\$ 2,000,000
								\$
	AUTOMOBILE LIABILITY						COMBINED SINGLE LIMIT (Ea accident)	\$
	<input type="checkbox"/> ANY AUTO						BODILY INJURY (Per person)	\$
	<input type="checkbox"/> ALL OWNED AUTOS	<input type="checkbox"/>	<input type="checkbox"/>	SCHEDULED AUTOS			BODILY INJURY (Per accident)	\$
	<input type="checkbox"/> HIRED AUTOS	<input type="checkbox"/>	<input type="checkbox"/>	NON-OWNED AUTOS			PROPERTY DAMAGE (Per accident)	\$
								\$
	UMBRELLA LIAB						EACH OCCURRENCE	\$
	<input type="checkbox"/> OCCUR						AGGREGATE	\$
	EXCESS LIAB							\$
	<input type="checkbox"/> CLAIMS-MADE							\$
	DED			RETENTION \$				
	WORKERS COMPENSATION AND EMPLOYERS' LIABILITY						PER STATUTE	OTHER
	ANY PROPRIETOR/PARTNER/EXECUTIVE OFFICER/MEMBER EXCLUDED? (Mandatory in NH)	<input type="checkbox"/>	Y / N	N / A			E.L. EACH ACCIDENT	\$
	If yes, describe under DESCRIPTION OF OPERATIONS below						E.L. DISEASE - EA EMPLOYEE	\$
							E.L. DISEASE - POLICY LIMIT	\$

DESCRIPTION OF OPERATIONS / LOCATIONS / VEHICLES (ACORD 101, Additional Remarks Schedule, may be attached if more space is required)

CERTIFICATE HOLDER STATE OF WEST VIRGINIA PURCHASING DEPT 2019 WASHINGTON ST EAST CHARLESTON, WV 25305	CANCELLATION SHOULD ANY OF THE ABOVE DESCRIBED POLICIES BE CANCELLED BEFORE THE EXPIRATION DATE THEREOF, NOTICE WILL BE DELIVERED IN ACCORDANCE WITH THE POLICY PROVISIONS. AUTHORIZED REPRESENTATIVE 
---	--

© 1988-2014 ACORD CORPORATION. All rights reserved.

ADDENDUM ACKNOWLEDGEMENT FORM

SOLICITATION NO.: ARFQ DOT2100000029

Instructions: Please acknowledge receipt of all addenda issued with this solicitation by completing this addendum acknowledgment form. Check the box next to each addendum received and sign below. Failure to acknowledge addenda may result in bid disqualification. Acknowledgment: I hereby acknowledge receipt of the following addenda and have made the necessary revisions to my proposal, plans and/or specification, etc.

Addendum Numbers Received:
(Check the box next to each addendum received)

- | | |
|--|--|
| <input checked="" type="checkbox"/> Addendum No. 1 | <input type="checkbox"/> Addendum No. 6 |
| <input checked="" type="checkbox"/> Addendum No. 2 | <input type="checkbox"/> Addendum No. 7 |
| <input type="checkbox"/> Addendum No. 3 | <input type="checkbox"/> Addendum No. 8 |
| <input type="checkbox"/> Addendum No. 4 | <input type="checkbox"/> Addendum No. 9 |
| <input type="checkbox"/> Addendum No. 5 | <input type="checkbox"/> Addendum No. 10 |

I understand that failure to confirm the receipt of addenda may be cause for rejection of this bid. I further understand that any verbal representation made or assumed to be made during any oral discussion held between Vendor's representatives and any state personnel is not binding. Only the information issued in writing and added to the specifications by an official addendum is binding.

Greenbrier Excavating & Paving, Inc

Company

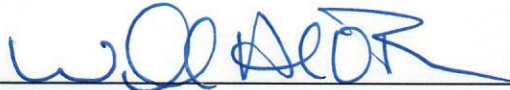

Authorized Signature

2/22/2021

Date

NOTE: This addendum acknowledgment should be submitted with the bid to expedite document processing.

AGENCY SOLICITATION NUMBER-ARFQ DOT2100000029
Addendum Number: 2

The Purpose of this addendum is to modify the solicitation identified as ("Agency Solicitation") to reflect the change(s) identified and described below.

Applicable Addendum Category:

- Modify bid opening date and time
- Modify specification of product or service being sought
- Attachment of pre-bid sign-in sheet
- Attachment of vendor questions and responses
- Correction of error
- Other

Description of Modification to Solicitation:

To extend the bid opening date from 02/18/21 to 02/23/21. Time remains at 2:30PM

Date: 02/23/2021 Time: 2:30PM

Additional Documentation: Documentation related to this Addendum (if any) has been included herewith as Attachment A and is specifically incorporated herein by reference.

Terms and Conditions:

1. All provision of the Agency Solicitation and other addenda not modified herein shall remain in full force and effect.
2. Vendor should acknowledge receipt of all addenda issued for this Agency Solicitation by completing an Addendum Acknowledgement, a copy of which is included herewith. Failure to acknowledge addenda may result in bid disqualification. The addendum acknowledgement should be submitted with the bid to expedite document processing.