



Department of Administration
 Purchasing Division
 2019 Washington Street East
 Post Office Box 50130
 Charleston, WV 25305-0130

**State of West Virginia
 Solicitation Response**

Proc Folder: 1480203
Solicitation Description: Asphalt Materials, Delivery & Labor by Vendor 6624C096
Proc Type: Agency Master Agreement

| Solicitation Closes | Solicitation Response | Version |
|---------------------|------------------------------|---------|
| 2024-09-19 10:30 | SR 0803 ESR09172400000002034 | 1 |

VENDOR
 000000209277
 J & M HEATING & AIR CONDITIONING INC

Solicitation Number: ARFQ 0803 DOT2500000011
Total Bid: 0
Response Date: 2024-09-17
Response Time: 16:22:02
Comments:

FOR INFORMATION CONTACT THE BUYER
 Dusty J Smith
 304-414-6859
 dusty.j.smith@wv.gov

Vendor Signature X **FEIN#** **DATE**

All offers subject to all terms and conditions contained in this solicitation

| Line | Comm Ln Desc | Qty | Unit Issue | Unit Price | Ln Total Or Contract Amount |
|------|------------------------------|---------|------------|------------|-----------------------------|
| 1 | Asphalt Section 401 - Base I | 0.00000 | TON | 145.000000 | 0.00 |

| Comm Code | Manufacturer | Specification | Model # |
|-----------|--------------|---------------|---------|
| 30121600 | | | |

Commodity Line Comments:

Extended Description:

Vendor shall provide bid pricing on the ATT A and ATT B Pricing Pages. Pricing or notations made in wvOASIS commodity line description areas will not be considered for bid evaluation or award.

| Line | Comm Ln Desc | Qty | Unit Issue | Unit Price | Ln Total Or Contract Amount |
|------|--------------------------------------|---------|------------|------------|-----------------------------|
| 2 | Asphalt Section 401 - 25mm Superpave | 0.00000 | TON | | |

| Comm Code | Manufacturer | Specification | Model # |
|-----------|--------------|---------------|---------|
| 30121600 | | | |

Commodity Line Comments: NO Bid

Extended Description:

Vendor shall provide bid pricing on the ATT A and ATT B Pricing Pages. Pricing or notations made in wvOASIS commodity line description areas will not be considered for bid evaluation or award.

| Line | Comm Ln Desc | Qty | Unit Issue | Unit Price | Ln Total Or Contract Amount |
|------|-------------------------------|---------|------------|------------|-----------------------------|
| 3 | Asphalt Section 401 - Base II | 0.00000 | TON | 145.000000 | 0.00 |

| Comm Code | Manufacturer | Specification | Model # |
|-----------|--------------|---------------|---------|
| 30121600 | | | |

Commodity Line Comments:

Extended Description:

Vendor shall provide bid pricing on the ATT A and ATT B Pricing Pages. Pricing or notations made in wvOASIS commodity line description areas will not be considered for bid evaluation or award.

| Line | Comm Ln Desc | Qty | Unit Issue | Unit Price | Ln Total Or Contract Amount |
|------|---------------------------------------|---------|------------|------------|-----------------------------|
| 4 | Asphalt Section 401 - Patch and Level | 0.00000 | TON | 155.000000 | 0.00 |

| Comm Code | Manufacturer | Specification | Model # |
|-----------|--------------|---------------|---------|
| 30121600 | | | |

Commodity Line Comments:

Extended Description:

Vendor shall provide bid pricing on the ATT A and ATT B Pricing Pages. Pricing or notations made in wvOASIS commodity line description areas will not be considered for bid evaluation or award.

| Line | Comm Ln Desc | Qty | Unit Issue | Unit Price | Ln Total Or Contract Amount |
|------|----------------------------------|---------|------------|------------|-----------------------------|
| 5 | Asphalt Section 401 - Wearing IV | 0.00000 | TON | | |

| Comm Code | Manufacturer | Specification | Model # |
|-----------|--------------|---------------|---------|
| 30121600 | | | |

Commodity Line Comments: NO Bid

Extended Description:

Vendor shall provide bid pricing on the ATT A and ATT B Pricing Pages. Pricing or notations made in wvOASIS commodity line description areas will not be considered for bid evaluation or award.

| Line | Comm Ln Desc | Qty | Unit Issue | Unit Price | Ln Total Or Contract Amount |
|------|----------------------------------|---------|------------|------------|-----------------------------|
| 6 | Asphalt Section 402 - Wearing IV | 0.00000 | TON | | |

| Comm Code | Manufacturer | Specification | Model # |
|-----------|--------------|---------------|---------|
| 30121600 | | | |

Commodity Line Comments: NO Bid

Extended Description:

Vendor shall provide bid pricing on the ATT A and ATT B Pricing Pages. Pricing or notations made in wvOASIS commodity line description areas will not be considered for bid evaluation or award.

| Line | Comm Ln Desc | Qty | Unit Issue | Unit Price | Ln Total Or Contract Amount |
|------|--------------------------------------|---------|------------|------------|-----------------------------|
| 7 | Asphalt Section 401 - 19mm Superpave | 0.00000 | TON | | |

| Comm Code | Manufacturer | Specification | Model # |
|-----------|--------------|---------------|---------|
| 30121600 | | | |

Commodity Line Comments: NO Bid

Extended Description:

Vendor shall provide bid pricing on the ATT A and ATT B Pricing Pages. Pricing or notations made in wvOASIS commodity line description areas will not be considered for bid evaluation or award.

| Line | Comm Ln Desc | Qty | Unit Issue | Unit Price | Ln Total Or Contract Amount |
|------|--------------------------------------|---------|------------|------------|-----------------------------|
| 8 | Asphalt Section 401 - Scratch Course | 0.00000 | TON | 155.000000 | 0.00 |

| Comm Code | Manufacturer | Specification | Model # |
|-----------|--------------|---------------|---------|
| 30121600 | | | |

Commodity Line Comments:

Extended Description:

Vendor shall provide bid pricing on the ATT A and ATT B Pricing Pages. Pricing or notations made in wvOASIS commodity line description areas will not be considered for bid evaluation or award.

| Line | Comm Ln Desc | Qty | Unit Issue | Unit Price | Ln Total Or Contract Amount |
|------|---------------------------------------|---------|------------|------------|-----------------------------|
| 9 | Asphalt Section 402 - 9.5mm Superpave | 0.00000 | TON | | |

| Comm Code | Manufacturer | Specification | Model # |
|-----------|--------------|---------------|---------|
| 30121600 | | | |

Commodity Line Comments: NO Bid

Extended Description:

Vendor shall provide bid pricing on the ATT A and ATT B Pricing Pages. Pricing or notations made in wvOASIS commodity line description areas will not be considered for bid evaluation or award.

| Line | Comm Ln Desc | Qty | Unit Issue | Unit Price | Ln Total Or Contract Amount |
|------|---------------------------------|---------|------------|------------|-----------------------------|
| 10 | Asphalt Section 401 - Wearing 1 | 0.00000 | TON | 155.000000 | 0.00 |

| Comm Code | Manufacturer | Specification | Model # |
|-----------|--------------|---------------|---------|
| 30121600 | | | |

Commodity Line Comments:

Extended Description:

Vendor shall provide bid pricing on the ATT A and ATT B Pricing Pages. Pricing or notations made in wvOASIS commodity line description areas will not be considered for bid evaluation or award.

| Line | Comm Ln Desc | Qty | Unit Issue | Unit Price | Ln Total Or Contract Amount |
|------|---------------------------------|---------|------------|------------|-----------------------------|
| 11 | Asphalt Section 402 - Wearing 1 | 0.00000 | TON | 165.000000 | 0.00 |

| Comm Code | Manufacturer | Specification | Model # |
|-----------|--------------|---------------|---------|
| 30121600 | | | |

Commodity Line Comments:

Extended Description:

Vendor shall provide bid pricing on the ATT A and ATT B Pricing Pages. Pricing or notations made in wvOASIS commodity line description areas will not be considered for bid evaluation or award.

| Line | Comm Ln Desc | Qty | Unit Issue | Unit Price | Ln Total Or Contract Amount |
|------|--|---------|------------|------------|-----------------------------|
| 12 | Asphalt Section 401 - 4.75mm Superpave | 0.00000 | TON | | |

| Comm Code | Manufacturer | Specification | Model # |
|-----------|--------------|---------------|---------|
| 30121600 | | | |

Commodity Line Comments: NO Bid

Extended Description:

Vendor shall provide bid pricing on the ATT A and ATT B Pricing Pages. Pricing or notations made in wvOASIS commodity line description areas will not be considered for bid evaluation or award.

| Line | Comm Ln Desc | Qty | Unit Issue | Unit Price | Ln Total Or Contract Amount |
|------|--|---------|------------|------------|-----------------------------|
| 13 | Asphalt Section 402 - 4.75mm Superpave | 0.00000 | TON | | |

| Comm Code | Manufacturer | Specification | Model # |
|-----------|--------------|---------------|---------|
| 30121600 | | | |

Commodity Line Comments: NO Bid

Extended Description:

Vendor shall provide bid pricing on the ATT A and ATT B Pricing Pages. Pricing or notations made in wvOASIS commodity line description areas will not be considered for bid evaluation or award.

| Line | Comm Ln Desc | Qty | Unit Issue | Unit Price | Ln Total Or Contract Amount |
|------|-----------------------------------|---------|------------|------------|-----------------------------|
| 14 | Asphalt Section 401 - Wearing III | 0.00000 | TON | | |

| Comm Code | Manufacturer | Specification | Model # |
|-----------|--------------|---------------|---------|
| 30121600 | | | |

Commodity Line Comments: NO Bid

Extended Description:

Vendor shall provide bid pricing on the ATT A and ATT B Pricing Pages. Pricing or notations made in wvOASIS commodity line description areas will not be considered for bid evaluation or award.

| Line | Comm Ln Desc | Qty | Unit Issue | Unit Price | Ln Total Or Contract Amount |
|------|-----------------------------------|---------|------------|------------|-----------------------------|
| 15 | Asphalt Section 402 - Wearing III | 0.00000 | TON | | |

| Comm Code | Manufacturer | Specification | Model # |
|-----------|--------------|---------------|---------|
| 30121600 | | | |

Commodity Line Comments: NO Bid

Extended Description:

Vendor shall provide bid pricing on the ATT A and ATT B Pricing Pages. Pricing or notations made in wvOASIS commodity line description areas will not be considered for bid evaluation or award.

| Line | Comm Ln Desc | Qty | Unit Issue | Unit Price | Ln Total Or Contract Amount |
|------|--|---------|------------|------------|-----------------------------|
| 16 | Asphalt Section 401 - 12.5mm Superpave | 0.00000 | TON | | |

| Comm Code | Manufacturer | Specification | Model # |
|-----------|--------------|---------------|---------|
| 30121600 | | | |

Commodity Line Comments: NO Bid

Extended Description:

Vendor shall provide bid pricing on the ATT A and ATT B Pricing Pages. Pricing or notations made in wvOASIS commodity line description areas will not be considered for bid evaluation or award.

| Line | Comm Ln Desc | Qty | Unit Issue | Unit Price | Ln Total Or Contract Amount |
|------|--|---------|------------|------------|-----------------------------|
| 17 | Asphalt Section 402 - 12.5mm Superpave | 0.00000 | TON | | |

| Comm Code | Manufacturer | Specification | Model # |
|-----------|--------------|---------------|---------|
| 30121600 | | | |

Commodity Line Comments: NO Bid

Extended Description:

Vendor shall provide bid pricing on the ATT A and ATT B Pricing Pages. Pricing or notations made in wvOASIS commodity line description areas will not be considered for bid evaluation or award.

| Line | Comm Ln Desc | Qty | Unit Issue | Unit Price | Ln Total Or Contract Amount |
|------|---|---------|------------|------------|-----------------------------|
| 18 | Shoulder Stone Placement for Asphalt Section 307 - Class 10 | 0.00000 | TON | | |

| Comm Code | Manufacturer | Specification | Model # |
|-----------|--------------|---------------|---------|
| 30111800 | | | |

Commodity Line Comments: NO Bid

Extended Description:

Vendor shall provide bid pricing on the ATT A and ATT B Pricing Pages. Pricing or notations made in wvOASIS commodity line description areas will not be considered for bid evaluation or award.

| Line | Comm Ln Desc | Qty | Unit Issue | Unit Price | Ln Total Or Contract Amount |
|------|---|---------|------------|------------|-----------------------------|
| 19 | Shoulder Stone Mobilization (ATT B Pricing Pages) | 0.00000 | LS | | |

| Comm Code | Manufacturer | Specification | Model # |
|-----------|--------------|---------------|---------|
| 24000000 | | | |

Commodity Line Comments: NO Bid

Extended Description:

Vendor shall provide bid pricing on the ATT A and ATT B Pricing Pages. Pricing or notations made in wvOASIS commodity line description areas will not be considered for bid evaluation or award.

| Line | Comm Ln Desc | Qty | Unit Issue | Unit Price | Ln Total Or Contract Amount |
|------|--|---------|------------|------------|-----------------------------|
| 20 | Haul by Vendor Shoulder Stone Placement - First Ton Mile | 0.00000 | MILE | | |

| Comm Code | Manufacturer | Specification | Model # |
|-----------|--------------|---------------|---------|
| 78120000 | | | |

Commodity Line Comments: NO Bid

Extended Description:

Vendor shall provide bid pricing on the ATT A and ATT B Pricing Pages. Pricing or notations made in wvOASIS commodity line description areas will not be considered for bid evaluation or award.

| Line | Comm Ln Desc | Qty | Unit Issue | Unit Price | Ln Total Or Contract Amount |
|------|--|---------|------------|------------|-----------------------------|
| 21 | Haul by Vendor Shoulder Stone Placement - Ea. Add'l Ton Mile | 0.00000 | MILE | | |

| Comm Code | Manufacturer | Specification | Model # |
|-----------|--------------|---------------|---------|
| 78120000 | | | |

Commodity Line Comments: NO Bid

Extended Description:

Vendor shall provide bid pricing on the ATT A and ATT B Pricing Pages. Pricing or notations made in wvOASIS commodity line description areas will not be considered for bid evaluation or award.

| Line | Comm Ln Desc | Qty | Unit Issue | Unit Price | Ln Total Or Contract Amount |
|------|--------------------------------|---------|------------|------------|-----------------------------|
| 22 | Surcharge for PG Binder 58-28S | 0.00000 | TON | | |

| Comm Code | Manufacturer | Specification | Model # |
|-----------|--------------|---------------|---------|
| 12161804 | | | |

Commodity Line Comments: NO Bid

Extended Description:

Vendor shall provide bid pricing on the ATT A and ATT B Pricing Pages. Pricing or notations made in wvOASIS commodity line description areas will not be considered for bid evaluation or award.

| Line | Comm Ln Desc | Qty | Unit Issue | Unit Price | Ln Total Or Contract Amount |
|------|--------------------------------------|---------|------------|------------|-----------------------------|
| 23 | Surcharge for PG Binder 64H minus 22 | 0.00000 | MILE | | |

| Comm Code | Manufacturer | Specification | Model # |
|-----------|--------------|---------------|---------|
| 12161804 | | | |

Commodity Line Comments: NO Bid

Extended Description:

Vendor shall provide bid pricing on the ATT A and ATT B Pricing Pages. Pricing or notations made in wvOASIS commodity line description areas will not be considered for bid evaluation or award.

| Line | Comm Ln Desc | Qty | Unit Issue | Unit Price | Ln Total Or Contract Amount |
|------|---|---------|------------|------------|-----------------------------|
| 24 | Surcharge for PG Binder 64E minus 22 (400 Ton increments) | 0.00000 | TON | | |

| Comm Code | Manufacturer | Specification | Model # |
|-----------|--------------|---------------|---------|
| 12161804 | | | |

Commodity Line Comments: NO Bid

Extended Description:

Vendor shall provide bid pricing on the ATT A and ATT B Pricing Pages. Pricing or notations made in wvOASIS commodity line description areas will not be considered for bid evaluation or award.

| Line | Comm Ln Desc | Qty | Unit Issue | Unit Price | Ln Total Or Contract Amount |
|------|--|---------|------------|------------|-----------------------------|
| 25 | ESAL Surcharge - 3 million to 20 million ESALs | 0.00000 | TON | | |

| Comm Code | Manufacturer | Specification | Model # |
|-----------|--------------|---------------|---------|
| 30121600 | | | |

Commodity Line Comments: NO Bid

Extended Description:

Vendor shall provide bid pricing on the ATT A and ATT B Pricing Pages. Pricing or notations made in wvOASIS commodity line description areas will not be considered for bid evaluation or award.

| Line | Comm Ln Desc | Qty | Unit Issue | Unit Price | Ln Total Or Contract Amount |
|------|--|---------|------------|------------|-----------------------------|
| 26 | ESAL Surcharge - Greater than 20 million ESALs | 0.00000 | TON | | |

| Comm Code | Manufacturer | Specification | Model # |
|-----------|--------------|---------------|---------|
| 30121600 | | | |

Commodity Line Comments: NO Bid

Extended Description:

Vendor shall provide bid pricing on the ATT A and ATT B Pricing Pages. Pricing or notations made in wvOASIS commodity line description areas will not be considered for bid evaluation or award.

| Line | Comm Ln Desc | Qty | Unit Issue | Unit Price | Ln Total Or Contract Amount |
|------|---|---------|------------|------------|-----------------------------|
| 27 | Asphalt Haul by Vendor - First Ton Mile | 0.00000 | MILE | 5.950000 | 0.00 |

| Comm Code | Manufacturer | Specification | Model # |
|-----------|--------------|---------------|---------|
| 78120000 | | | |

Commodity Line Comments:

Extended Description:

Vendor shall provide bid pricing on the ATT A and ATT B Pricing Pages. Pricing or notations made in wvOASIS commodity line description areas will not be considered for bid evaluation or award.

| Line | Comm Ln Desc | Qty | Unit Issue | Unit Price | Ln Total Or Contract Amount |
|------|---|---------|------------|------------|-----------------------------|
| 28 | Asphalt Haul by Vendor - Each Additional Ton Mile | 0.00000 | MILE | 2.950000 | 0.00 |

| Comm Code | Manufacturer | Specification | Model # |
|-----------|--------------|---------------|---------|
| 78120000 | | | |

Commodity Line Comments:

Extended Description:

Vendor shall provide bid pricing on the ATT A and ATT B Pricing Pages. Pricing or notations made in wvOASIS commodity line description areas will not be considered for bid evaluation or award.

| Line | Comm Ln Desc | Qty | Unit Issue | Unit Price | Ln Total Or Contract Amount |
|------|--|---------|------------|------------|-----------------------------|
| 29 | Laydown of Material Items #1-17, Each Site 0-100 Tons | 0.00000 | TON | 95.000000 | 0.00 |

| Comm Code | Manufacturer | Specification | Model # |
|-----------|--------------|---------------|---------|
| 72141100 | | | |

Commodity Line Comments:

Extended Description:

Vendor shall provide bid pricing on the ATT A and ATT B Pricing Pages. Pricing or notations made in wvOASIS commodity line description areas will not be considered for bid evaluation or award.

| Line | Comm Ln Desc | Qty | Unit Issue | Unit Price | Ln Total Or Contract Amount |
|------|---|---------|------------|------------|-----------------------------|
| 30 | Laydown of Material Items #1-17, Each Site 101 to 200 Tons | 0.00000 | TON | 85.000000 | 0.00 |

| Comm Code | Manufacturer | Specification | Model # |
|-----------|--------------|---------------|---------|
| 72141100 | | | |

Commodity Line Comments:

Extended Description:

Vendor shall provide bid pricing on the ATT A and ATT B Pricing Pages. Pricing or notations made in wvOASIS commodity line description areas will not be considered for bid evaluation or award.

| Line | Comm Ln Desc | Qty | Unit Issue | Unit Price | Ln Total Or Contract Amount |
|------|---|---------|------------|------------|-----------------------------|
| 31 | Laydown of Material Items #1-17, Each Site 201 to 500 Tons | 0.00000 | TON | 75.000000 | 0.00 |

| Comm Code | Manufacturer | Specification | Model # |
|-----------|--------------|---------------|---------|
| 72141100 | | | |

Commodity Line Comments:

Extended Description:

Vendor shall provide bid pricing on the ATT A and ATT B Pricing Pages. Pricing or notations made in wvOASIS commodity line description areas will not be considered for bid evaluation or award.

| Line | Comm Ln Desc | Qty | Unit Issue | Unit Price | Ln Total Or Contract Amount |
|------|---|---------|------------|------------|-----------------------------|
| 32 | Laydown of Material Items #1-17, Each Site 501 Tons or > | 0.00000 | TON | 70.000000 | 0.00 |

| Comm Code | Manufacturer | Specification | Model # |
|-----------|--------------|---------------|---------|
| 72141100 | | | |

Commodity Line Comments:

Extended Description:

Vendor shall provide bid pricing on the ATT A and ATT B Pricing Pages. Pricing or notations made in wvOASIS commodity line description areas will not be considered for bid evaluation or award.

| Line | Comm Ln Desc | Qty | Unit Issue | Unit Price | Ln Total Or Contract Amount |
|------|--|---------|------------|-------------|-----------------------------|
| 33 | Daytime Paving Mobilization (ATT B Pricing Pages) | 0.00000 | LS | 2500.000000 | 0.00 |

| Comm Code | Manufacturer | Specification | Model # |
|-----------|--------------|---------------|---------|
| 24000000 | | | |

Commodity Line Comments:**Extended Description:**

Vendor shall provide bid pricing on the ATT A and ATT B Pricing Pages. Pricing or notations made in wvOASIS commodity line description areas will not be considered for bid evaluation or award.

| Line | Comm Ln Desc | Qty | Unit Issue | Unit Price | Ln Total Or Contract Amount |
|------|---|---------|------------|--------------|-----------------------------|
| 34 | Nighttime Paving Mobilization (ATT B Pricing Pages) | 0.00000 | LS | 15000.000000 | 0.00 |

| Comm Code | Manufacturer | Specification | Model # |
|-----------|--------------|---------------|---------|
| 24000000 | | | |

Commodity Line Comments:**Extended Description:**

Vendor shall provide bid pricing on the ATT A and ATT B Pricing Pages. Pricing or notations made in wvOASIS commodity line description areas will not be considered for bid evaluation or award.

| Line | Comm Ln Desc | Qty | Unit Issue | Unit Price | Ln Total Or Contract Amount |
|------|---|---------|------------|------------|-----------------------------|
| 35 | Excavation for Shoulder Paving - 0 to 1000 SY | 0.00000 | SY | | |

| Comm Code | Manufacturer | Specification | Model # |
|-----------|--------------|---------------|---------|
| 72141505 | | | |

Commodity Line Comments: NO Bid**Extended Description:**

Vendor shall provide bid pricing on the ATT A and ATT B Pricing Pages. Pricing or notations made in wvOASIS commodity line description areas will not be considered for bid evaluation or award.

| Line | Comm Ln Desc | Qty | Unit Issue | Unit Price | Ln Total Or Contract Amount |
|------|--|---------|------------|------------|-----------------------------|
| 36 | Excavation for Shoulder Paving - 1001 to 2000 SY | 0.00000 | SY | | |

| Comm Code | Manufacturer | Specification | Model # |
|-----------|--------------|---------------|---------|
| 72141505 | | | |

Commodity Line Comments: NO Bid**Extended Description:**

Vendor shall provide bid pricing on the ATT A and ATT B Pricing Pages. Pricing or notations made in wvOASIS commodity line description areas will not be considered for bid evaluation or award.

| Line | Comm Ln Desc | Qty | Unit Issue | Unit Price | Ln Total Or Contract Amount |
|------|--|---------|------------|------------|-----------------------------|
| 37 | Excavation for Shoulder Paving - 2001 to 3000 SY | 0.00000 | SY | | |

| Comm Code | Manufacturer | Specification | Model # |
|-----------|--------------|---------------|---------|
| 72141505 | | | |

Commodity Line Comments: NO Bid**Extended Description:**

Vendor shall provide bid pricing on the ATT A and ATT B Pricing Pages. Pricing or notations made in wvOASIS commodity line description areas will not be considered for bid evaluation or award.

| Line | Comm Ln Desc | Qty | Unit Issue | Unit Price | Ln Total Or Contract Amount |
|------|---|---------|------------|------------|-----------------------------|
| 38 | Excavation for Shoulder Paving - 3001 SY or > | 0.00000 | TON | | |

| Comm Code | Manufacturer | Specification | Model # |
|-----------|--------------|---------------|---------|
| 72141505 | | | |

Commodity Line Comments: NO Bid

Extended Description:

Vendor shall provide bid pricing on the ATT A and ATT B Pricing Pages. Pricing or notations made in wvOASIS commodity line description areas will not be considered for bid evaluation or award.

| Line | Comm Ln Desc | Qty | Unit Issue | Unit Price | Ln Total Or Contract Amount |
|------|--|---------|------------|------------|-----------------------------|
| 39 | Asphalt Base I Shoulder Paving Surcharge - 0 to 100 Tons | 0.00000 | TON | | |

| Comm Code | Manufacturer | Specification | Model # |
|-----------|--------------|---------------|---------|
| 72141100 | | | |

Commodity Line Comments: NO Bid

Extended Description:

Vendor shall provide bid pricing on the ATT A and ATT B Pricing Pages. Pricing or notations made in wvOASIS commodity line description areas will not be considered for bid evaluation or award.

| Line | Comm Ln Desc | Qty | Unit Issue | Unit Price | Ln Total Or Contract Amount |
|------|--|---------|------------|------------|-----------------------------|
| 40 | Asphalt Base I Shoulder Paving Surcharge - 101 to 200 Tons | 0.00000 | TON | | |

| Comm Code | Manufacturer | Specification | Model # |
|-----------|--------------|---------------|---------|
| 72141100 | | | |

Commodity Line Comments: NO Bid

Extended Description:

Vendor shall provide bid pricing on the ATT A and ATT B Pricing Pages. Pricing or notations made in wvOASIS commodity line description areas will not be considered for bid evaluation or award.

| Line | Comm Ln Desc | Qty | Unit Issue | Unit Price | Ln Total Or Contract Amount |
|------|--|---------|------------|------------|-----------------------------|
| 41 | Asphalt Base I Shoulder Paving Surcharge - 201 to 500 Tons | 0.00000 | TON | | |

| Comm Code | Manufacturer | Specification | Model # |
|-----------|--------------|---------------|---------|
| 72141100 | | | |

Commodity Line Comments: NO Bid

Extended Description:

Vendor shall provide bid pricing on the ATT A and ATT B Pricing Pages. Pricing or notations made in wvOASIS commodity line description areas will not be considered for bid evaluation or award.

| Line | Comm Ln Desc | Qty | Unit Issue | Unit Price | Ln Total Or Contract Amount |
|------|--|---------|------------|------------|-----------------------------|
| 42 | Asphalt Base I Shoulder Paving Surcharge - 501 Tons or > | 0.00000 | TON | | |

| Comm Code | Manufacturer | Specification | Model # |
|-----------|--------------|---------------|---------|
| 72141100 | | | |

Commodity Line Comments: NO Bid

Extended Description:

Vendor shall provide bid pricing on the ATT A and ATT B Pricing Pages. Pricing or notations made in wvOASIS commodity line description areas will not be considered for bid evaluation or award.

| Line | Comm Ln Desc | Qty | Unit Issue | Unit Price | Ln Total Or Contract Amount |
|------|--|---------|------------|------------|-----------------------------|
| 43 | Asphalt Base II Shoulder Paving Surcharge - 0 to 100 Tons | 0.00000 | TON | | |

| Comm Code | Manufacturer | Specification | Model # |
|-----------|--------------|---------------|---------|
| 72141100 | | | |

Commodity Line Comments: NO Bid

Extended Description:

Vendor shall provide bid pricing on the ATT A and ATT B Pricing Pages. Pricing or notations made in wvOASIS commodity line description areas will not be considered for bid evaluation or award.

| Line | Comm Ln Desc | Qty | Unit Issue | Unit Price | Ln Total Or Contract Amount |
|------|--|---------|------------|------------|-----------------------------|
| 44 | Asphalt Base II Shoulder Paving Surcharge - 101 to 200 Tons | 0.00000 | TON | | |

| Comm Code | Manufacturer | Specification | Model # |
|-----------|--------------|---------------|---------|
| 72141100 | | | |

Commodity Line Comments: NO Bid

Extended Description:

Vendor shall provide bid pricing on the ATT A and ATT B Pricing Pages. Pricing or notations made in wvOASIS commodity line description areas will not be considered for bid evaluation or award.

| Line | Comm Ln Desc | Qty | Unit Issue | Unit Price | Ln Total Or Contract Amount |
|------|--|---------|------------|------------|-----------------------------|
| 45 | Asphalt Base II Shoulder Paving Surcharge - 201 to 500 Tons | 0.00000 | TON | | |

| Comm Code | Manufacturer | Specification | Model # |
|-----------|--------------|---------------|---------|
| 72141100 | | | |

Commodity Line Comments: NO Bid

Extended Description:

Vendor shall provide bid pricing on the ATT A and ATT B Pricing Pages. Pricing or notations made in wvOASIS commodity line description areas will not be considered for bid evaluation or award.

| Line | Comm Ln Desc | Qty | Unit Issue | Unit Price | Ln Total Or Contract Amount |
|------|---|---------|------------|------------|-----------------------------|
| 46 | Asphalt Base II Shoulder Paving Surcharge- 501 TN or > | 0.00000 | TON | | |

| Comm Code | Manufacturer | Specification | Model # |
|-----------|--------------|---------------|---------|
| 72141100 | | | |

Commodity Line Comments: NO Bid

Extended Description:

Vendor shall provide bid pricing on the ATT A and ATT B Pricing Pages. Pricing or notations made in wvOASIS commodity line description areas will not be considered for bid evaluation or award.

| Line | Comm Ln Desc | Qty | Unit Issue | Unit Price | Ln Total Or Contract Amount |
|------|--------------------------------|---------|------------|------------|-----------------------------|
| 47 | Asphalt Material for Tack Coat | 0.00000 | GL | 4.950000 | 0.00 |

| Comm Code | Manufacturer | Specification | Model # |
|-----------|--------------|---------------|---------|
| 12161804 | | | |

Commodity Line Comments:**Extended Description:**

Vendor shall provide bid pricing on the ATT A and ATT B Pricing Pages. Pricing or notations made in wvOASIS commodity line description areas will not be considered for bid evaluation or award.

| Line | Comm Ln Desc | Qty | Unit Issue | Unit Price | Ln Total Or Contract Amount |
|------|---------------------------|---------|------------|------------|-----------------------------|
| 48 | Additional Heel-In Joints | 0.00000 | LF | 13.000000 | 0.00 |

| Comm Code | Manufacturer | Specification | Model # |
|-----------|--------------|---------------|---------|
| 72141100 | | | |

Commodity Line Comments:**Extended Description:**

Vendor shall provide bid pricing on the ATT A and ATT B Pricing Pages. Pricing or notations made in wvOASIS commodity line description areas will not be considered for bid evaluation or award.

| Line | Comm Ln Desc | Qty | Unit Issue | Unit Price | Ln Total Or Contract Amount |
|------|-----------------------|---------|------------|------------|-----------------------------|
| 49 | Skip Paving Surcharge | 0.00000 | TON | 10.000000 | 0.00 |

| Comm Code | Manufacturer | Specification | Model # |
|-----------|--------------|---------------|---------|
| 72141100 | | | |

Commodity Line Comments:**Extended Description:**

Vendor shall provide bid pricing on the ATT A and ATT B Pricing Pages. Pricing or notations made in wvOASIS commodity line description areas will not be considered for bid evaluation or award.

| Line | Comm Ln Desc | Qty | Unit Issue | Unit Price | Ln Total Or Contract Amount |
|------|---|---------|------------|------------|-----------------------------|
| 50 | Pavement Profiling/Milling-WVDOH Owns Millings 0-250 SY | 0.00000 | SY | 25.000000 | 0.00 |

| Comm Code | Manufacturer | Specification | Model # |
|-----------|--------------|---------------|---------|
| 72141100 | | | |

Commodity Line Comments:**Extended Description:**

Vendor shall provide bid pricing on the ATT A and ATT B Pricing Pages. Pricing or notations made in wvOASIS commodity line description areas will not be considered for bid evaluation or award.

| Line | Comm Ln Desc | Qty | Unit Issue | Unit Price | Ln Total Or Contract Amount |
|------|---|---------|------------|------------|-----------------------------|
| 51 | Pavement Profiling/Milling-WVDOH Owns Millings 251-500 SY | 0.00000 | SY | 20.000000 | 0.00 |

| Comm Code | Manufacturer | Specification | Model # |
|-----------|--------------|---------------|---------|
| 72141100 | | | |

Commodity Line Comments:**Extended Description:**

Vendor shall provide bid pricing on the ATT A and ATT B Pricing Pages. Pricing or notations made in wvOASIS commodity line description areas will not be considered for bid evaluation or award.

| Line | Comm Ln Desc | Qty | Unit Issue | Unit Price | Ln Total Or Contract Amount |
|------|--|---------|------------|------------|-----------------------------|
| 52 | Pavement Profiling/Milling-WVDOH Owns Millings 501-1000 SY | 0.00000 | SY | 15.000000 | 0.00 |

| Comm Code | Manufacturer | Specification | Model # |
|-----------|--------------|---------------|---------|
| 72141100 | | | |

Commodity Line Comments:

Extended Description:

Vendor shall provide bid pricing on the ATT A and ATT B Pricing Pages. Pricing or notations made in wvOASIS commodity line description areas will not be considered for bid evaluation or award.

| Line | Comm Ln Desc | Qty | Unit Issue | Unit Price | Ln Total Or Contract Amount |
|------|---|---------|------------|------------|-----------------------------|
| 53 | Pavement Profiling/Milling-WVDOH Owns Millings 1001-2500 SY | 0.00000 | SY | 12.000000 | 0.00 |

| Comm Code | Manufacturer | Specification | Model # |
|-----------|--------------|---------------|---------|
| 72141100 | | | |

Commodity Line Comments:

Extended Description:

Vendor shall provide bid pricing on the ATT A and ATT B Pricing Pages. Pricing or notations made in wvOASIS commodity line description areas will not be considered for bid evaluation or award.

| Line | Comm Ln Desc | Qty | Unit Issue | Unit Price | Ln Total Or Contract Amount |
|------|---|---------|------------|------------|-----------------------------|
| 54 | Pavement Profiling/Milling-WVDOH Owns Millings 2501-5000 SY | 0.00000 | SY | 10.000000 | 0.00 |

| Comm Code | Manufacturer | Specification | Model # |
|-----------|--------------|---------------|---------|
| 72141100 | | | |

Commodity Line Comments:

Extended Description:

Vendor shall provide bid pricing on the ATT A and ATT B Pricing Pages. Pricing or notations made in wvOASIS commodity line description areas will not be considered for bid evaluation or award.

| Line | Comm Ln Desc | Qty | Unit Issue | Unit Price | Ln Total Or Contract Amount |
|------|---|---------|------------|------------|-----------------------------|
| 55 | Pavement Profiling/Milling-WVDOH Owns Millings 5001 SY or > | 0.00000 | SY | 8.000000 | 0.00 |

| Comm Code | Manufacturer | Specification | Model # |
|-----------|--------------|---------------|---------|
| 72141100 | | | |

Commodity Line Comments:

Extended Description:

Vendor shall provide bid pricing on the ATT A and ATT B Pricing Pages. Pricing or notations made in wvOASIS commodity line description areas will not be considered for bid evaluation or award.

| Line | Comm Ln Desc | Qty | Unit Issue | Unit Price | Ln Total Or Contract Amount |
|------|---|---------|------------|------------|-----------------------------|
| 56 | Pavement Profiling/Milling-Vendor Owns Millings 0 to 250 SY | 0.00000 | SY | 25.000000 | 0.00 |

| Comm Code | Manufacturer | Specification | Model # |
|-----------|--------------|---------------|---------|
| 72141100 | | | |

Commodity Line Comments:

Extended Description:

Vendor shall provide bid pricing on the ATT A and ATT B Pricing Pages. Pricing or notations made in wvOASIS commodity line description areas will not be considered for bid evaluation or award.

| Line | Comm Ln Desc | Qty | Unit Issue | Unit Price | Ln Total Or Contract Amount |
|------|--|---------|------------|------------|-----------------------------|
| 57 | Pavement Profiling/Milling-Vendor Owns Millings 251-500 SY | 0.00000 | SY | 20.000000 | 0.00 |

| Comm Code | Manufacturer | Specification | Model # |
|-----------|--------------|---------------|---------|
| 12161804 | | | |

Commodity Line Comments:

Extended Description:

Vendor shall provide bid pricing on the ATT A and ATT B Pricing Pages. Pricing or notations made in wvOASIS commodity line description areas will not be considered for bid evaluation or award.

| Line | Comm Ln Desc | Qty | Unit Issue | Unit Price | Ln Total Or Contract Amount |
|------|---|---------|------------|------------|-----------------------------|
| 58 | Pavement Profiling/Milling-Vendor Owns Millings 501-1000 SY | 0.00000 | SY | 15.000000 | 0.00 |

| Comm Code | Manufacturer | Specification | Model # |
|-----------|--------------|---------------|---------|
| 72141100 | | | |

Commodity Line Comments:

Extended Description:

Vendor shall provide bid pricing on the ATT A and ATT B Pricing Pages. Pricing or notations made in wvOASIS commodity line description areas will not be considered for bid evaluation or award.

| Line | Comm Ln Desc | Qty | Unit Issue | Unit Price | Ln Total Or Contract Amount |
|------|--|---------|------------|------------|-----------------------------|
| 59 | Pavement Profiling/Milling-Vendor Owns Millings 1001-2500 SY | 0.00000 | SY | 12.000000 | 0.00 |

| Comm Code | Manufacturer | Specification | Model # |
|-----------|--------------|---------------|---------|
| 72141100 | | | |

Commodity Line Comments:

Extended Description:

Vendor shall provide bid pricing on the ATT A and ATT B Pricing Pages. Pricing or notations made in wvOASIS commodity line description areas will not be considered for bid evaluation or award.

| Line | Comm Ln Desc | Qty | Unit Issue | Unit Price | Ln Total Or Contract Amount |
|------|--|---------|------------|------------|-----------------------------|
| 60 | Pavement Profiling/Milling-Vendor Owns Millings 2501-5000 SY | 0.00000 | SY | 10.000000 | 0.00 |

| Comm Code | Manufacturer | Specification | Model # |
|-----------|--------------|---------------|---------|
| 72141100 | | | |

Commodity Line Comments:

Extended Description:

Vendor shall provide bid pricing on the ATT A and ATT B Pricing Pages. Pricing or notations made in wvOASIS commodity line description areas will not be considered for bid evaluation or award.

| Line | Comm Ln Desc | Qty | Unit Issue | Unit Price | Ln Total Or Contract Amount |
|------|--|---------|------------|------------|-----------------------------|
| 61 | Pavement Profiling/Milling-Vendor Owns Millings 5001 SY or > | 0.00000 | SY | 8.000000 | 0.00 |

| Comm Code | Manufacturer | Specification | Model # |
|-----------|--------------|---------------|---------|
| 72141100 | | | |

Commodity Line Comments:

Extended Description:

Vendor shall provide bid pricing on the ATT A and ATT B Pricing Pages. Pricing or notations made in wvOASIS commodity line description areas will not be considered for bid evaluation or award.

| Line | Comm Ln Desc | Qty | Unit Issue | Unit Price | Ln Total Or Contract Amount |
|------|--|---------|------------|-------------|-----------------------------|
| 62 | Pavement Profiling/Milling Mobilization (ATT B Pricing Page) | 0.00000 | LS | 4500.000000 | 0.00 |

| Comm Code | Manufacturer | Specification | Model # |
|-----------|--------------|---------------|---------|
| 24000000 | | | |

Commodity Line Comments:

Extended Description:

Vendor shall provide bid pricing on the ATT A and ATT B Pricing Pages. Pricing or notations made in wvOASIS commodity line description areas will not be considered for bid evaluation or award.

| Line | Comm Ln Desc | Qty | Unit Issue | Unit Price | Ln Total Or Contract Amount |
|------|---|---------|------------|------------|-----------------------------|
| 63 | Haul of Profiled/Milled Cuttings or Fine Millings-1st 10 mi | 0.00000 | MILE | | |

| Comm Code | Manufacturer | Specification | Model # |
|-----------|--------------|---------------|---------|
| 78120000 | | | |

Commodity Line Comments: NO Bid

Extended Description:

Haul of Profiled/Milled Cuttings or Fine Millings, First 10 Miles
(Included with #50-61 and #70-81)

Vendor shall provide bid pricing on the ATT A and ATT B Pricing Pages. Pricing or notations made in wvOASIS commodity line description areas will not be considered for bid evaluation or award.

| Line | Comm Ln Desc | Qty | Unit Issue | Unit Price | Ln Total Or Contract Amount |
|------|--|---------|------------|------------|-----------------------------|
| 64 | Haul of Profiled/Milled Cuttings or Fine Millings-Add'l Mile | 0.00000 | MILE | 2.950000 | 0.00 |

| Comm Code | Manufacturer | Specification | Model # |
|-----------|--------------|---------------|---------|
| 78120000 | | | |

Commodity Line Comments:

Extended Description:

Haul of Profiled/Milled Cuttings or Fine Millings (each additional Ton Mile after 10 miles)

Vendor shall provide bid pricing on the ATT A and ATT B Pricing Pages. Pricing or notations made in wvOASIS commodity line description areas will not be considered for bid evaluation or award.

| Line | Comm Ln Desc | Qty | Unit Issue | Unit Price | Ln Total Or Contract Amount |
|------|---------------------------------|---------|------------|------------|-----------------------------|
| 65 | Pavement Repair-Asphalt Base II | 0.00000 | SY | 600.000000 | 0.00 |

| Comm Code | Manufacturer | Specification | Model # |
|-----------|--------------|---------------|---------|
| 72141100 | | | |

Commodity Line Comments:

Extended Description:

Vendor shall provide bid pricing on the ATT A and ATT B Pricing Pages. Pricing or notations made in wvOASIS commodity line description areas will not be considered for bid evaluation or award.

| Line | Comm Ln Desc | Qty | Unit Issue | Unit Price | Ln Total Or Contract Amount |
|------|---|---------|------------|------------|-----------------------------|
| 66 | Asphalt HPTO - SP496 - PG 64E-22 (400 Ton increments) | 0.00000 | TON | | |

| Comm Code | Manufacturer | Specification | Model # |
|-----------|--------------|---------------|---------|
| 30121600 | | | |

Commodity Line Comments: NO Bid

Extended Description:

Vendor shall provide bid pricing on the ATT A and ATT B Pricing Pages. Pricing or notations made in wvOASIS commodity line description areas will not be considered for bid evaluation or award.

| Line | Comm Ln Desc | Qty | Unit Issue | Unit Price | Ln Total Or Contract Amount |
|------|-------------------|---------|------------|------------|-----------------------------|
| 67 | Non-Tracking Tack | 0.00000 | GL | | |

| Comm Code | Manufacturer | Specification | Model # |
|-----------|--------------|---------------|---------|
| 12161804 | | | |

Commodity Line Comments: NO Bid

Extended Description:

Vendor shall provide bid pricing on the ATT A and ATT B Pricing Pages. Pricing or notations made in wvOASIS commodity line description areas will not be considered for bid evaluation or award.

| Line | Comm Ln Desc | Qty | Unit Issue | Unit Price | Ln Total Or Contract Amount |
|------|--|---------|------------|------------|-----------------------------|
| 68 | Lay Down of Materials - to be used with #65 - 400 Ton or > | 0.00000 | TON | | |

| Comm Code | Manufacturer | Specification | Model # |
|-----------|--------------|---------------|---------|
| 72141100 | | | |

Commodity Line Comments: NO Bid

Extended Description:

Vendor shall provide bid pricing on the ATT A and ATT B Pricing Pages. Pricing or notations made in wvOASIS commodity line description areas will not be considered for bid evaluation or award.

| Line | Comm Ln Desc | Qty | Unit Issue | Unit Price | Ln Total Or Contract Amount |
|------|------------------------------------|---------|------------|------------|-----------------------------|
| 69 | Ultra-Thin Asphalt Overlay - SP498 | 0.00000 | TON | | |

| Comm Code | Manufacturer | Specification | Model # |
|-----------|--------------|---------------|---------|
| 30121600 | | | |

Commodity Line Comments: NO Bid

Extended Description:

Vendor shall provide bid pricing on the ATT A and ATT B Pricing Pages. Pricing or notations made in wvOASIS commodity line description areas will not be considered for bid evaluation or award.

| Line | Comm Ln Desc | Qty | Unit Issue | Unit Price | Ln Total Or Contract Amount |
|------|--|---------|------------|------------|-----------------------------|
| 70 | Fine Milling -WVDOH Owns Millings 0-250 SY | 0.00000 | SY | | |

| Comm Code | Manufacturer | Specification | Model # |
|-----------|--------------|---------------|---------|
| 73181021 | | | |

Commodity Line Comments: NO Bid

Extended Description:

Vendor shall provide bid pricing on the ATT A and ATT B Pricing Pages. Pricing or notations made in wvOASIS commodity line description areas will not be considered for bid evaluation or award.

| Line | Comm Ln Desc | Qty | Unit Issue | Unit Price | Ln Total Or Contract Amount |
|------|--|---------|------------|------------|-----------------------------|
| 71 | Fine Milling -WVDOH Owns Millings 251-500 SY | 0.00000 | SY | | |

| Comm Code | Manufacturer | Specification | Model # |
|-----------|--------------|---------------|---------|
| 73181021 | | | |

Commodity Line Comments: NO Bid

Extended Description:

Vendor shall provide bid pricing on the ATT A and ATT B Pricing Pages. Pricing or notations made in wvOASIS commodity line description areas will not be considered for bid evaluation or award.

| Line | Comm Ln Desc | Qty | Unit Issue | Unit Price | Ln Total Or Contract Amount |
|------|---|---------|------------|------------|-----------------------------|
| 72 | Fine Milling -WVDOH Owns Millings 501-1000 SY | 0.00000 | SY | | |

| Comm Code | Manufacturer | Specification | Model # |
|-----------|--------------|---------------|---------|
| 73181021 | | | |

Commodity Line Comments: NO Bid

Extended Description:

Vendor shall provide bid pricing on the ATT A and ATT B Pricing Pages. Pricing or notations made in wvOASIS commodity line description areas will not be considered for bid evaluation or award.

| Line | Comm Ln Desc | Qty | Unit Issue | Unit Price | Ln Total Or Contract Amount |
|------|--|---------|------------|------------|-----------------------------|
| 73 | Fine Milling -WVDOH Owns Millings 1,001-2,500 SY | 0.00000 | SY | | |

| Comm Code | Manufacturer | Specification | Model # |
|-----------|--------------|---------------|---------|
| 73181021 | | | |

Commodity Line Comments: NO Bid

Extended Description:

Vendor shall provide bid pricing on the ATT A and ATT B Pricing Pages. Pricing or notations made in wvOASIS commodity line description areas will not be considered for bid evaluation or award.

| Line | Comm Ln Desc | Qty | Unit Issue | Unit Price | Ln Total Or Contract Amount |
|------|--|---------|------------|------------|-----------------------------|
| 74 | Fine Milling -WVDOH Owns Millings 2,501 to 5,000 Sq. Yards | 0.00000 | SY | | |

| Comm Code | Manufacturer | Specification | Model # |
|-----------|--------------|---------------|---------|
| 73181021 | | | |

Commodity Line Comments: NO Bid

Extended Description:

Vendor shall provide bid pricing on the ATT A and ATT B Pricing Pages. Pricing or notations made in wvOASIS commodity line description areas will not be considered for bid evaluation or award.

| Line | Comm Ln Desc | Qty | Unit Issue | Unit Price | Ln Total Or Contract Amount |
|------|---|---------|------------|------------|-----------------------------|
| 75 | Fine Milling -WVDOH Owns Millings 5,001 SY or > | 0.00000 | SY | | |

| Comm Code | Manufacturer | Specification | Model # |
|-----------|--------------|---------------|---------|
| 73181021 | | | |

Commodity Line Comments: NO Bid

Extended Description:

Vendor shall provide bid pricing on the ATT A and ATT B Pricing Pages. Pricing or notations made in wvOASIS commodity line description areas will not be considered for bid evaluation or award.

| Line | Comm Ln Desc | Qty | Unit Issue | Unit Price | Ln Total Or Contract Amount |
|------|--|---------|------------|------------|-----------------------------|
| 76 | Fine Milling- Vendor Owns Millings 0 -250 SY | 0.00000 | SY | | |

| Comm Code | Manufacturer | Specification | Model # |
|-----------|--------------|---------------|---------|
| 73181021 | | | |

Commodity Line Comments: NO Bid

Extended Description:

Vendor shall provide bid pricing on the ATT A and ATT B Pricing Pages. Pricing or notations made in wvOASIS commodity line description areas will not be considered for bid evaluation or award.

| Line | Comm Ln Desc | Qty | Unit Issue | Unit Price | Ln Total Or Contract Amount |
|------|---|---------|------------|------------|-----------------------------|
| 77 | Fine Milling- Vendor Owns Millings 251-500 SY | 0.00000 | SY | | |

| Comm Code | Manufacturer | Specification | Model # |
|-----------|--------------|---------------|---------|
| 73181021 | | | |

Commodity Line Comments: NO Bid

Extended Description:

Vendor shall provide bid pricing on the ATT A and ATT B Pricing Pages. Pricing or notations made in wvOASIS commodity line description areas will not be considered for bid evaluation or award.

| Line | Comm Ln Desc | Qty | Unit Issue | Unit Price | Ln Total Or Contract Amount |
|------|---|---------|------------|------------|-----------------------------|
| 78 | Fine Milling- Vendor Owns Millings 501 to 1,000 Sq. Yards | 0.00000 | SY | | |

| Comm Code | Manufacturer | Specification | Model # |
|-----------|--------------|---------------|---------|
| 73181021 | | | |

Commodity Line Comments: NO Bid

Extended Description:

Vendor shall provide bid pricing on the ATT A and ATT B Pricing Pages. Pricing or notations made in wvOASIS commodity line description areas will not be considered for bid evaluation or award.

| Line | Comm Ln Desc | Qty | Unit Issue | Unit Price | Ln Total Or Contract Amount |
|------|--|---------|------------|------------|-----------------------------|
| 79 | Fine Milling- Vendor Owns Millings 1,001- 2,500 SY | 0.00000 | SY | | |

| Comm Code | Manufacturer | Specification | Model # |
|-----------|--------------|---------------|---------|
| 73181021 | | | |

Commodity Line Comments: NO Bid

Extended Description:

Vendor shall provide bid pricing on the ATT A and ATT B Pricing Pages. Pricing or notations made in wvOASIS commodity line description areas will not be considered for bid evaluation or award.

| Line | Comm Ln Desc | Qty | Unit Issue | Unit Price | Ln Total Or Contract Amount |
|------|---|---------|------------|------------|-----------------------------|
| 80 | Fine Milling- Vendor Owns Millings 2,501-5,000 SY | 0.00000 | SY | | |

| Comm Code | Manufacturer | Specification | Model # |
|-----------|--------------|---------------|---------|
| 73181021 | | | |

Commodity Line Comments: NO Bid

Extended Description:

Vendor shall provide bid pricing on the ATT A and ATT B Pricing Pages. Pricing or notations made in wvOASIS commodity line description areas will not be considered for bid evaluation or award.

| Line | Comm Ln Desc | Qty | Unit Issue | Unit Price | Ln Total Or Contract Amount |
|------|---|---------|------------|------------|-----------------------------|
| 81 | Fine Milling- Vendor Owns Millings 5,001 or > | 0.00000 | SY | | |

| Comm Code | Manufacturer | Specification | Model # |
|-----------|--------------|---------------|---------|
| 73181021 | | | |

Commodity Line Comments: NO Bid

Extended Description:

Vendor shall provide bid pricing on the ATT A and ATT B Pricing Pages. Pricing or notations made in wvOASIS commodity line description areas will not be considered for bid evaluation or award.

| Line | Comm Ln Desc | Qty | Unit Issue | Unit Price | Ln Total Or Contract Amount |
|------|----------------------|---------|------------|------------|-----------------------------|
| 82 | Milled Rumble Strips | 0.00000 | LF | 0.750000 | 0.00 |

| Comm Code | Manufacturer | Specification | Model # |
|-----------|--------------|---------------|---------|
| 73181021 | | | |

Commodity Line Comments:

Extended Description:

Vendor shall provide bid pricing on the ATT A and ATT B Pricing Pages. Pricing or notations made in wvOASIS commodity line description areas will not be considered for bid evaluation or award.

| Line | Comm Ln Desc | Qty | Unit Issue | Unit Price | Ln Total Or Contract Amount |
|------|--|---------|------------|-------------|-----------------------------|
| 83 | Milled Rumble Strip Mobilization (ATT B Pricing Pages) | 0.00000 | LS | 4900.000000 | 0.00 |

| Comm Code | Manufacturer | Specification | Model # |
|-----------|--------------|---------------|---------|
| 24000000 | | | |

Commodity Line Comments:

Extended Description:

Vendor shall provide bid pricing on the ATT A and ATT B Pricing Pages. Pricing or notations made in wvOASIS commodity line description areas will not be considered for bid evaluation or award.

| Line | Comm Ln Desc | Qty | Unit Issue | Unit Price | Ln Total Or Contract Amount |
|------|---|---------|------------|------------|-----------------------------|
| 84 | Parking Lot and Facility Paving Surcharge | 0.00000 | TON | 9.500000 | 0.00 |

| Comm Code | Manufacturer | Specification | Model # |
|-----------|--------------|---------------|---------|
| 30121600 | | | |

Commodity Line Comments:**Extended Description:**

Parking Lot and Facility Paving Surcharge - Items Nos. 1-17, 65, and 68

Vendor shall provide bid pricing on the ATT A and ATT B Pricing Pages. Pricing or notations made in wvOASIS commodity line description areas will not be considered for bid evaluation or award.

| Line | Comm Ln Desc | Qty | Unit Issue | Unit Price | Ln Total Or Contract Amount |
|------|-----------------------|---------|------------|------------|-----------------------------|
| 85 | Cleaning and Sweeping | 0.00000 | SY | 1.000000 | 0.00 |

| Comm Code | Manufacturer | Specification | Model # |
|-----------|--------------|---------------|---------|
| 72141100 | | | |

Commodity Line Comments:**Extended Description:**

Vendor shall provide bid pricing on the ATT A and ATT B Pricing Pages. Pricing or notations made in wvOASIS commodity line description areas will not be considered for bid evaluation or award.

| Line | Comm Ln Desc | Qty | Unit Issue | Unit Price | Ln Total Or Contract Amount |
|------|---|---------|------------|-------------|-----------------------------|
| 86 | Traffic Maintenance: Pilot Truck and Driver | 0.00000 | DAY | 1200.000000 | 0.00 |

| Comm Code | Manufacturer | Specification | Model # |
|-----------|--------------|---------------|---------|
| 46161500 | | | |

Commodity Line Comments:**Extended Description:**

Vendor shall provide bid pricing on the ATT A and ATT B Pricing Pages. Pricing or notations made in wvOASIS commodity line description areas will not be considered for bid evaluation or award.

| Line | Comm Ln Desc | Qty | Unit Issue | Unit Price | Ln Total Or Contract Amount |
|------|--|---------|------------|------------|-----------------------------|
| 87 | Traffic Maintenance: Traffic Control Devices | 0.00000 | UNIT | 2.000000 | 0.00 |

| Comm Code | Manufacturer | Specification | Model # |
|-----------|--------------|---------------|---------|
| 46161500 | | | |

Commodity Line Comments:**Extended Description:**

Vendor shall provide bid pricing on the ATT A and ATT B Pricing Pages. Pricing or notations made in wvOASIS commodity line description areas will not be considered for bid evaluation or award.

| Line | Comm Ln Desc | Qty | Unit Issue | Unit Price | Ln Total Or Contract Amount |
|------|------------------------------|---------|------------|------------|-----------------------------|
| 88 | Traffic Maintenance: Flagger | 0.00000 | HOUR | 95.000000 | 0.00 |

| Comm Code | Manufacturer | Specification | Model # |
|-----------|--------------|---------------|---------|
| 46161500 | | | |

Commodity Line Comments:**Extended Description:**

Vendor shall provide bid pricing on the ATT A and ATT B Pricing Pages. Pricing or notations made in wvOASIS commodity line description areas will not be considered for bid evaluation or award.

| Line | Comm Ln Desc | Qty | Unit Issue | Unit Price | Ln Total Or Contract Amount |
|------|----------------------------------|---------|------------|------------|-----------------------------|
| 89 | Traffic Maintenance: Arrow Board | 0.00000 | DAY | 80.000000 | 0.00 |

| Comm Code | Manufacturer | Specification | Model # |
|-----------|--------------|---------------|---------|
| 46161500 | | | |

Commodity Line Comments:

Extended Description:

Vendor shall provide bid pricing on the ATT A and ATT B Pricing Pages. Pricing or notations made in wvOASIS commodity line description areas will not be considered for bid evaluation or award.

| Line | Comm Ln Desc | Qty | Unit Issue | Unit Price | Ln Total Or Contract Amount |
|------|--------------------------------------|---------|------------|------------|-----------------------------|
| 90 | Off-Season Plant Opening - First Day | 0.00000 | DAY | | |

| Comm Code | Manufacturer | Specification | Model # |
|-----------|--------------|---------------|---------|
| 30121600 | | | |

Commodity Line Comments: NO Bid

Extended Description:

Vendor shall provide bid pricing on the ATT A and ATT B Pricing Pages. Pricing or notations made in wvOASIS commodity line description areas will not be considered for bid evaluation or award.

| Line | Comm Ln Desc | Qty | Unit Issue | Unit Price | Ln Total Or Contract Amount |
|------|--|---------|------------|------------|-----------------------------|
| 91 | Off-Season Plant Opening - Each Additional Day | 0.00000 | DAY | | |

| Comm Code | Manufacturer | Specification | Model # |
|-----------|--------------|---------------|---------|
| 30121600 | | | |

Commodity Line Comments: NO Bid

Extended Description:

Vendor shall provide bid pricing on the ATT A and ATT B Pricing Pages. Pricing or notations made in wvOASIS commodity line description areas will not be considered for bid evaluation or award.

| Line | Comm Ln Desc | Qty | Unit Issue | Unit Price | Ln Total Or Contract Amount |
|------|--|---------|------------|------------|-----------------------------|
| 92 | Raised Pavement Marker (RPM), Type R-4 with Installation | 0.00000 | EA | | |

| Comm Code | Manufacturer | Specification | Model # |
|-----------|--------------|---------------|---------|
| 72151306 | | | |

Commodity Line Comments: NO Bid

Extended Description:

Vendor shall provide bid pricing on the ATT A and ATT B Pricing Pages. Pricing or notations made in wvOASIS commodity line description areas will not be considered for bid evaluation or award.

| Line | Comm Ln Desc | Qty | Unit Issue | Unit Price | Ln Total Or Contract Amount |
|------|--|---------|------------|------------|-----------------------------|
| 93 | Raised Pavement Marker (RPM), Type R-4 with Installation | 0.00000 | EA | | |

| Comm Code | Manufacturer | Specification | Model # |
|-----------|--------------|---------------|---------|
| 72151306 | | | |

Commodity Line Comments: NO Bid

Extended Description:

Vendor shall provide bid pricing on the ATT A and ATT B Pricing Pages. Pricing or notations made in wvOASIS commodity line description areas will not be considered for bid evaluation or award.

| Line | Comm Ln Desc | Qty | Unit Issue | Unit Price | Ln Total Or Contract Amount |
|------|---|---------|------------|------------|-----------------------------|
| 94 | RPM Installation Mobilization (ATT B Pricing Pages) | 0.00000 | LS | | |

| Comm Code | Manufacturer | Specification | Model # |
|-----------|--------------|---------------|---------|
| 24000000 | | | |

Commodity Line Comments: NO Bid

Extended Description:

Vendor shall provide bid pricing on the ATT A and ATT B Pricing Pages. Pricing or notations made in wvOASIS commodity line description areas will not be considered for bid evaluation or award.

| Line | Comm Ln Desc | Qty | Unit Issue | Unit Price | Ln Total Or Contract Amount |
|------|--------------------------------------|---------|------------|------------|-----------------------------|
| 95 | Raised Pavement Marker (RPM) Removal | 0.00000 | EA | | |

| Comm Code | Manufacturer | Specification | Model # |
|-----------|--------------|---------------|---------|
| 72151306 | | | |

Commodity Line Comments: NO Bid

Extended Description:

Vendor shall provide bid pricing on the ATT A and ATT B Pricing Pages. Pricing or notations made in wvOASIS commodity line description areas will not be considered for bid evaluation or award.

| Line | Comm Ln Desc | Qty | Unit Issue | Unit Price | Ln Total Or Contract Amount |
|------|--|---------|------------|------------|-----------------------------|
| 96 | RPM Removal Mobilization (ATT B Pricing Pages) | 0.00000 | LS | | |

| Comm Code | Manufacturer | Specification | Model # |
|-----------|--------------|---------------|---------|
| 24000000 | | | |

Commodity Line Comments: NO Bid

Extended Description:

Vendor shall provide bid pricing on the ATT A and ATT B Pricing Pages. Pricing or notations made in wvOASIS commodity line description areas will not be considered for bid evaluation or award.

| Line | Comm Ln Desc | Qty | Unit Issue | Unit Price | Ln Total Or Contract Amount |
|------|--|---------|------------|------------|-----------------------------|
| 97 | VRAM (Void Reducing Asphalt Membrane) 0-1,000 LF | 0.00000 | LF | | |

| Comm Code | Manufacturer | Specification | Model # |
|-----------|--------------|---------------|---------|
| 30121600 | | | |

Commodity Line Comments: NO Bid

Extended Description:

Vendor shall provide bid pricing on the ATT A and ATT B Pricing Pages. Pricing or notations made in wvOASIS commodity line description areas will not be considered for bid evaluation or award.

| Line | Comm Ln Desc | Qty | Unit Issue | Unit Price | Ln Total Or Contract Amount |
|------|--|---------|------------|------------|-----------------------------|
| 98 | VRAM (Void Reducing Asphalt Membrane) 1,001-2,000 LF | 0.00000 | LF | | |

| Comm Code | Manufacturer | Specification | Model # |
|-----------|--------------|---------------|---------|
| 30121600 | | | |

Commodity Line Comments: NO Bid

Extended Description:

Vendor shall provide bid pricing on the ATT A and ATT B Pricing Pages. Pricing or notations made in wvOASIS commodity line description areas will not be considered for bid evaluation or award.

| Line | Comm Ln Desc | Qty | Unit Issue | Unit Price | Ln Total Or Contract Amount |
|------|---|---------|------------|------------|-----------------------------|
| 99 | VRAM (Void Reducing Asphalt Membrane) 2,001-5,000 LF | 0.00000 | LF | | |

| Comm Code | Manufacturer | Specification | Model # |
|-----------|--------------|---------------|---------|
| 30121600 | | | |

Commodity Line Comments: NO Bid

Extended Description:

Vendor shall provide bid pricing on the ATT A and ATT B Pricing Pages. Pricing or notations made in wvOASIS commodity line description areas will not be considered for bid evaluation or award.

| Line | Comm Ln Desc | Qty | Unit Issue | Unit Price | Ln Total Or Contract Amount |
|------|--|---------|------------|------------|-----------------------------|
| 100 | VRAM (Void Reducing Asphalt Membrane) 5,001 LF or greater | 0.00000 | LF | | |

| Comm Code | Manufacturer | Specification | Model # |
|-----------|--------------|---------------|---------|
| 30121600 | | | |

Commodity Line Comments: NO Bid

Extended Description:

Vendor shall provide bid pricing on the ATT A and ATT B Pricing Pages. Pricing or notations made in wvOASIS commodity line description areas will not be considered for bid evaluation or award.

| Line | Comm Ln Desc | Qty | Unit Issue | Unit Price | Ln Total Or Contract Amount |
|------|---|---------|------------|------------|-----------------------------|
| 101 | VRAM Preparation - Removal of Center Line | 0.00000 | LF | | |

| Comm Code | Manufacturer | Specification | Model # |
|-----------|--------------|---------------|---------|
| 30121600 | | | |

Commodity Line Comments: NO Bid

Extended Description:

Vendor shall provide bid pricing on the ATT A and ATT B Pricing Pages. Pricing or notations made in wvOASIS commodity line description areas will not be considered for bid evaluation or award.

| Line | Comm Ln Desc | Qty | Unit Issue | Unit Price | Ln Total Or Contract Amount |
|------|---|---------|------------|------------|-----------------------------|
| 102 | VRAM Mobilization (ATT B Pricing Pages) | 0.00000 | LF | | |

| Comm Code | Manufacturer | Specification | Model # |
|-----------|--------------|---------------|---------|
| 30121600 | | | |

Commodity Line Comments: NO Bid

Extended Description:

Vendor shall provide bid pricing on the ATT A and ATT B Pricing Pages. Pricing or notations made in wvOASIS commodity line description areas will not be considered for bid evaluation or award.



**State of West Virginia
Agency Request for Quote
Highways**

| | | | |
|--|----------------------------|---------------------------------|----------------|
| Proc Folder: 1480203 | | Reason for Modification: | |
| Doc Description: Asphalt Materials, Delivery & Labor by Vendor 6624C096 | | Addendum 1 | |
| Proc Type: Agency Master Agreement | | | |
| Date Issued | Solicitation Closes | Solicitation No | Version |
| 2024-09-17 | 2024-09-19 10:30 | ARFQ 0803 DOT2500000011 | 3 |

| BID RECEIVING LOCATION | |
|--|--|
| PROCUREMENT DIVISION DIVISION OF HIGHWAYS BLDG 6 RM 340A 1900 KANAWHA BLVD E CHARLESTON WV 25305 US | |

| VENDOR | |
|---|---|
| Vendor Customer Code: 000000209277 | |
| Vendor Name : J&M Heating and Air Conditioning, INC DBA J&M Paving & Sealing | |
| Address : 367 | |
| Street : Daytona Drive | |
| City : Princeton | |
| State : West Virginia | Country : United States Zip : 24739 |
| Principal Contact : Joseph Meadows | |
| Vendor Contact Phone: 304-425-5445 | Extension: |

| FOR INFORMATION CONTACT THE BUYER | |
|---|--|
| Dusty J Smith 304-414-6859 dusty.j.smith@wv.gov | |

| | | |
|--|-------------------------|------------------------|
| Vendor Signature X <i>Joe Meadows</i> | FEIN# 55-0751946 | DATE 09/17/2024 |
|--|-------------------------|------------------------|

All offers subject to all terms and conditions contained in this solicitation

ADDITIONAL INFORMATION

ADDENDUM 1 IS ISSUED FOR THE FOLLOWING REASONS:

1. On August 23, 2024 there was an issue with the Let Date No Addendum was issued

2. Revising the Terms and Conditions with the correct contract term

NO OTHER CHANGES

| INVOICE TO | | SHIP TO | |
|---|----|---|----|
| VARIOUS AGENCY LOCATIONS AS INDICATED BY ORDER | | VARIOUS AGENCY LOCATIONS AS INDICATED BY ORDER | |
| No City US | WV | No City US | WV |

| Line | Comm Ln Desc | Qty | Unit Issue | Unit Price | Total Price |
|------|------------------------------|---------|------------|------------|-------------|
| 1 | Asphalt Section 401 - Base I | 0.00000 | TON | | |

| Comm Code | Manufacturer | Specification | Model # |
|-----------|--------------|---------------|---------|
| 30121600 | | | |

Extended Description:

Vendor shall provide bid pricing on the ATT A and ATT B Pricing Pages. Pricing or notations made in wvOASIS commodity line description areas will not be considered for bid evaluation or award.

| INVOICE TO | | SHIP TO | |
|---|----|---|----|
| VARIOUS AGENCY LOCATIONS AS INDICATED BY ORDER | | VARIOUS AGENCY LOCATIONS AS INDICATED BY ORDER | |
| No City US | WV | No City US | WV |

| Line | Comm Ln Desc | Qty | Unit Issue | Unit Price | Total Price |
|------|--------------------------------------|---------|------------|------------|-------------|
| 2 | Asphalt Section 401 - 25mm Superpave | 0.00000 | TON | | |

| Comm Code | Manufacturer | Specification | Model # |
|-----------|--------------|---------------|---------|
| 30121600 | | | |

Extended Description:

Vendor shall provide bid pricing on the ATT A and ATT B Pricing Pages. Pricing or notations made in wvOASIS commodity line description areas will not be considered for bid evaluation or award.

| INVOICE TO | | SHIP TO | |
|---|----|---|----|
| VARIOUS AGENCY LOCATIONS AS INDICATED BY ORDER | | VARIOUS AGENCY LOCATIONS AS INDICATED BY ORDER | |
| No City | WV | No City | WV |
| US | | US | |

| Line | Comm Ln Desc | Qty | Unit Issue | Unit Price | Total Price |
|------|-------------------------------|---------|------------|------------|-------------|
| 3 | Asphalt Section 401 - Base II | 0.00000 | TON | | |

| Comm Code | Manufacturer | Specification | Model # |
|-----------|--------------|---------------|---------|
| 30121600 | | | |

Extended Description:

Vendor shall provide bid pricing on the ATT A and ATT B Pricing Pages. Pricing or notations made in wvOASIS commodity line description areas will not be considered for bid evaluation or award.

| INVOICE TO | | SHIP TO | |
|---|----|---|----|
| VARIOUS AGENCY LOCATIONS AS INDICATED BY ORDER | | VARIOUS AGENCY LOCATIONS AS INDICATED BY ORDER | |
| No City | WV | No City | WV |
| US | | US | |

| Line | Comm Ln Desc | Qty | Unit Issue | Unit Price | Total Price |
|------|---------------------------------------|---------|------------|------------|-------------|
| 4 | Asphalt Section 401 - Patch and Level | 0.00000 | TON | | |

| Comm Code | Manufacturer | Specification | Model # |
|-----------|--------------|---------------|---------|
| 30121600 | | | |

Extended Description:

Vendor shall provide bid pricing on the ATT A and ATT B Pricing Pages. Pricing or notations made in wvOASIS commodity line description areas will not be considered for bid evaluation or award.

| INVOICE TO | | SHIP TO | |
|---|----|---|----|
| VARIOUS AGENCY LOCATIONS AS INDICATED BY ORDER | | VARIOUS AGENCY LOCATIONS AS INDICATED BY ORDER | |
| No City | WV | No City | WV |
| US | | US | |

| Line | Comm Ln Desc | Qty | Unit Issue | Unit Price | Total Price |
|------|----------------------------------|---------|------------|------------|-------------|
| 5 | Asphalt Section 401 - Wearing IV | 0.00000 | TON | | |

| Comm Code | Manufacturer | Specification | Model # |
|-----------|--------------|---------------|---------|
| 30121600 | | | |

Extended Description:

Vendor shall provide bid pricing on the ATT A and ATT B Pricing Pages. Pricing or notations made in wvOASIS commodity line description areas will not be considered for bid evaluation or award.

| INVOICE TO | | SHIP TO | |
|---|----|---|----|
| VARIOUS AGENCY LOCATIONS AS INDICATED BY ORDER | | VARIOUS AGENCY LOCATIONS AS INDICATED BY ORDER | |
| No City | WV | No City | WV |
| US | | US | |

| Line | Comm Ln Desc | Qty | Unit Issue | Unit Price | Total Price |
|------|----------------------------------|---------|------------|------------|-------------|
| 6 | Asphalt Section 402 - Wearing IV | 0.00000 | TON | | |

| Comm Code | Manufacturer | Specification | Model # |
|-----------|--------------|---------------|---------|
| 30121600 | | | |

Extended Description:

Vendor shall provide bid pricing on the ATT A and ATT B Pricing Pages. Pricing or notations made in wvOASIS commodity line description areas will not be considered for bid evaluation or award.

| INVOICE TO | | SHIP TO | |
|---|----|---|----|
| VARIOUS AGENCY LOCATIONS AS INDICATED BY ORDER | | VARIOUS AGENCY LOCATIONS AS INDICATED BY ORDER | |
| No City | WV | No City | WV |
| US | | US | |

| Line | Comm Ln Desc | Qty | Unit Issue | Unit Price | Total Price |
|------|--------------------------------------|---------|------------|------------|-------------|
| 7 | Asphalt Section 401 - 19mm Superpave | 0.00000 | TON | | |

| Comm Code | Manufacturer | Specification | Model # |
|-----------|--------------|---------------|---------|
| 30121600 | | | |

Extended Description:

Vendor shall provide bid pricing on the ATT A and ATT B Pricing Pages. Pricing or notations made in wvOASIS commodity line description areas will not be considered for bid evaluation or award.

| INVOICE TO | | SHIP TO | |
|---|----|---|----|
| VARIOUS AGENCY LOCATIONS AS INDICATED BY ORDER | | VARIOUS AGENCY LOCATIONS AS INDICATED BY ORDER | |
| No City | WV | No City | WV |
| US | | US | |

| Line | Comm Ln Desc | Qty | Unit Issue | Unit Price | Total Price |
|------|--------------------------------------|---------|------------|------------|-------------|
| 8 | Asphalt Section 401 - Scratch Course | 0.00000 | TON | | |

| Comm Code | Manufacturer | Specification | Model # |
|-----------|--------------|---------------|---------|
| 30121600 | | | |

Extended Description:

Vendor shall provide bid pricing on the ATT A and ATT B Pricing Pages. Pricing or notations made in wvOASIS commodity line description areas will not be considered for bid evaluation or award.

| INVOICE TO | | SHIP TO | |
|---|----|---|----|
| VARIOUS AGENCY LOCATIONS AS INDICATED BY ORDER | | VARIOUS AGENCY LOCATIONS AS INDICATED BY ORDER | |
| No City | WV | No City | WV |
| US | | US | |

| Line | Comm Ln Desc | Qty | Unit Issue | Unit Price | Total Price |
|------|---------------------------------------|---------|------------|------------|-------------|
| 9 | Asphalt Section 402 - 9.5mm Superpave | 0.00000 | TON | | |

| Comm Code | Manufacturer | Specification | Model # |
|-----------|--------------|---------------|---------|
| 30121600 | | | |

Extended Description:

Vendor shall provide bid pricing on the ATT A and ATT B Pricing Pages. Pricing or notations made in wvOASIS commodity line description areas will not be considered for bid evaluation or award.

| INVOICE TO | | SHIP TO | |
|---|----|---|----|
| VARIOUS AGENCY LOCATIONS AS INDICATED BY ORDER | | VARIOUS AGENCY LOCATIONS AS INDICATED BY ORDER | |
| No City | WV | No City | WV |
| US | | US | |

| Line | Comm Ln Desc | Qty | Unit Issue | Unit Price | Total Price |
|------|---------------------------------|---------|------------|------------|-------------|
| 10 | Asphalt Section 401 - Wearing 1 | 0.00000 | TON | | |

| Comm Code | Manufacturer | Specification | Model # |
|-----------|--------------|---------------|---------|
| 30121600 | | | |

Extended Description:

Vendor shall provide bid pricing on the ATT A and ATT B Pricing Pages. Pricing or notations made in wvOASIS commodity line description areas will not be considered for bid evaluation or award.

| INVOICE TO | | SHIP TO | |
|---|----|---|----|
| VARIOUS AGENCY LOCATIONS AS INDICATED BY ORDER | | VARIOUS AGENCY LOCATIONS AS INDICATED BY ORDER | |
| No City | WV | No City | WV |
| US | | US | |

| Line | Comm Ln Desc | Qty | Unit Issue | Unit Price | Total Price |
|------|---------------------------------|---------|------------|------------|-------------|
| 11 | Asphalt Section 402 - Wearing 1 | 0.00000 | TON | | |

| Comm Code | Manufacturer | Specification | Model # |
|-----------|--------------|---------------|---------|
| 30121600 | | | |

Extended Description:

Vendor shall provide bid pricing on the ATT A and ATT B Pricing Pages. Pricing or notations made in wvOASIS commodity line description areas will not be considered for bid evaluation or award.

| INVOICE TO | | SHIP TO | |
|---|----|---|----|
| VARIOUS AGENCY LOCATIONS AS INDICATED BY ORDER | | VARIOUS AGENCY LOCATIONS AS INDICATED BY ORDER | |
| No City | WV | No City | WV |
| US | | US | |

| Line | Comm Ln Desc | Qty | Unit Issue | Unit Price | Total Price |
|------|--|---------|------------|------------|-------------|
| 12 | Asphalt Section 401 - 4.75mm Superpave | 0.00000 | TON | | |

| Comm Code | Manufacturer | Specification | Model # |
|-----------|--------------|---------------|---------|
| 30121600 | | | |

Extended Description:

Vendor shall provide bid pricing on the ATT A and ATT B Pricing Pages. Pricing or notations made in wvOASIS commodity line description areas will not be considered for bid evaluation or award.

| INVOICE TO | | SHIP TO | |
|--|----|--|----|
| VARIOUS AGENCY LOCATIONS AS INDICATED BY ORDER | | VARIOUS AGENCY LOCATIONS AS INDICATED BY ORDER | |
| No City | WV | No City | WV |
| US | | US | |

| Line | Comm Ln Desc | Qty | Unit Issue | Unit Price | Total Price |
|------|--|---------|------------|------------|-------------|
| 13 | Asphalt Section 402 - 4.75mm Superpave | 0.00000 | TON | | |

| Comm Code | Manufacturer | Specification | Model # |
|-----------|--------------|---------------|---------|
| 30121600 | | | |

Extended Description:

Vendor shall provide bid pricing on the ATT A and ATT B Pricing Pages. Pricing or notations made in wvOASIS commodity line description areas will not be considered for bid evaluation or award.

| INVOICE TO | | SHIP TO | |
|--|----|--|----|
| VARIOUS AGENCY LOCATIONS AS INDICATED BY ORDER | | VARIOUS AGENCY LOCATIONS AS INDICATED BY ORDER | |
| No City | WV | No City | WV |
| US | | US | |

| Line | Comm Ln Desc | Qty | Unit Issue | Unit Price | Total Price |
|------|-----------------------------------|---------|------------|------------|-------------|
| 14 | Asphalt Section 401 - Wearing III | 0.00000 | TON | | |

| Comm Code | Manufacturer | Specification | Model # |
|-----------|--------------|---------------|---------|
| 30121600 | | | |

Extended Description:

Vendor shall provide bid pricing on the ATT A and ATT B Pricing Pages. Pricing or notations made in wvOASIS commodity line description areas will not be considered for bid evaluation or award.

| INVOICE TO | | SHIP TO | |
|---|----|---|----|
| VARIOUS AGENCY LOCATIONS AS INDICATED BY ORDER | | VARIOUS AGENCY LOCATIONS AS INDICATED BY ORDER | |
| No City | WV | No City | WV |
| US | | US | |

| Line | Comm Ln Desc | Qty | Unit Issue | Unit Price | Total Price |
|------|-----------------------------------|---------|------------|------------|-------------|
| 15 | Asphalt Section 402 - Wearing III | 0.00000 | TON | | |

| Comm Code | Manufacturer | Specification | Model # |
|-----------|--------------|---------------|---------|
| 30121600 | | | |

Extended Description:

Vendor shall provide bid pricing on the ATT A and ATT B Pricing Pages. Pricing or notations made in wvOASIS commodity line description areas will not be considered for bid evaluation or award.

| INVOICE TO | | SHIP TO | |
|---|----|---|----|
| VARIOUS AGENCY LOCATIONS AS INDICATED BY ORDER | | VARIOUS AGENCY LOCATIONS AS INDICATED BY ORDER | |
| No City | WV | No City | WV |
| US | | US | |

| Line | Comm Ln Desc | Qty | Unit Issue | Unit Price | Total Price |
|------|--|---------|------------|------------|-------------|
| 16 | Asphalt Section 401 - 12.5mm Superpave | 0.00000 | TON | | |

| Comm Code | Manufacturer | Specification | Model # |
|-----------|--------------|---------------|---------|
| 30121600 | | | |

Extended Description:

Vendor shall provide bid pricing on the ATT A and ATT B Pricing Pages. Pricing or notations made in wvOASIS commodity line description areas will not be considered for bid evaluation or award.

| INVOICE TO | | SHIP TO | |
|---|----|---|----|
| VARIOUS AGENCY LOCATIONS AS INDICATED BY ORDER | | VARIOUS AGENCY LOCATIONS AS INDICATED BY ORDER | |
| No City | WV | No City | WV |
| US | | US | |

| Line | Comm Ln Desc | Qty | Unit Issue | Unit Price | Total Price |
|------|--|---------|------------|------------|-------------|
| 17 | Asphalt Section 402 - 12.5mm Superpave | 0.00000 | TON | | |

| Comm Code | Manufacturer | Specification | Model # |
|-----------|--------------|---------------|---------|
| 30121600 | | | |

Extended Description:
Vendor shall provide bid pricing on the ATT A and ATT B Pricing Pages. Pricing or notations made in wvOASIS commodity line description areas will not be considered for bid evaluation or award.

| INVOICE TO | | SHIP TO | |
|---|----|---|----|
| VARIOUS AGENCY LOCATIONS AS INDICATED BY ORDER | | VARIOUS AGENCY LOCATIONS AS INDICATED BY ORDER | |
| No City | WV | No City | WV |
| US | | US | |

| Line | Comm Ln Desc | Qty | Unit Issue | Unit Price | Total Price |
|------|---|---------|------------|------------|-------------|
| 18 | Shoulder Stone Placement for Asphalt Section 307 - Class 10 | 0.00000 | TON | | |

| Comm Code | Manufacturer | Specification | Model # |
|-----------|--------------|---------------|---------|
| 30111800 | | | |

Extended Description:
Vendor shall provide bid pricing on the ATT A and ATT B Pricing Pages. Pricing or notations made in wvOASIS commodity line description areas will not be considered for bid evaluation or award.

| INVOICE TO | | SHIP TO | |
|---|----|---|----|
| VARIOUS AGENCY LOCATIONS AS INDICATED BY ORDER | | VARIOUS AGENCY LOCATIONS AS INDICATED BY ORDER | |
| No City | WV | No City | WV |
| US | | US | |

| Line | Comm Ln Desc | Qty | Unit Issue | Unit Price | Total Price |
|------|---|---------|------------|------------|-------------|
| 19 | Shoulder Stone Mobilization (ATT B Pricing Pages) | 0.00000 | LS | | |

| Comm Code | Manufacturer | Specification | Model # |
|-----------|--------------|---------------|---------|
| 24000000 | | | |

Extended Description:
Vendor shall provide bid pricing on the ATT A and ATT B Pricing Pages. Pricing or notations made in wvOASIS commodity line description areas will not be considered for bid evaluation or award.

| INVOICE TO | | SHIP TO | |
|---|----|---|----|
| VARIOUS AGENCY LOCATIONS AS INDICATED BY ORDER | | VARIOUS AGENCY LOCATIONS AS INDICATED BY ORDER | |
| No City | WV | No City | WV |
| US | | US | |

| Line | Comm Ln Desc | Qty | Unit Issue | Unit Price | Total Price |
|------|--|---------|------------|------------|-------------|
| 20 | Haul by Vendor Shoulder Stone Placement - First Ton Mile | 0.00000 | MILE | | |

| Comm Code | Manufacturer | Specification | Model # |
|-----------|--------------|---------------|---------|
| 78120000 | | | |

Extended Description:
Vendor shall provide bid pricing on the ATT A and ATT B Pricing Pages. Pricing or notations made in wvOASIS commodity line description areas will not be considered for bid evaluation or award.

| INVOICE TO | | SHIP TO | |
|---|----|---|----|
| VARIOUS AGENCY LOCATIONS AS INDICATED BY ORDER | | VARIOUS AGENCY LOCATIONS AS INDICATED BY ORDER | |
| No City US | WV | No City US | WV |

| Line | Comm Ln Desc | Qty | Unit Issue | Unit Price | Total Price |
|------|---|---------|------------|------------|-------------|
| 21 | Haul by Vendor Shoulder Stone Placement - Ea. Add'l Ton Mile | 0.00000 | MILE | | |

| Comm Code | Manufacturer | Specification | Model # |
|-----------|--------------|---------------|---------|
| 78120000 | | | |

Extended Description:
Vendor shall provide bid pricing on the ATT A and ATT B Pricing Pages. Pricing or notations made in wvOASIS commodity line description areas will not be considered for bid evaluation or award.

| INVOICE TO | | SHIP TO | |
|---|----|---|----|
| VARIOUS AGENCY LOCATIONS AS INDICATED BY ORDER | | VARIOUS AGENCY LOCATIONS AS INDICATED BY ORDER | |
| No City US | WV | No City US | WV |

| Line | Comm Ln Desc | Qty | Unit Issue | Unit Price | Total Price |
|------|--------------------------------|---------|------------|------------|-------------|
| 22 | Surcharge for PG Binder 58-28S | 0.00000 | TON | | |

| Comm Code | Manufacturer | Specification | Model # |
|-----------|--------------|---------------|---------|
| 12161804 | | | |

Extended Description:
Vendor shall provide bid pricing on the ATT A and ATT B Pricing Pages. Pricing or notations made in wvOASIS commodity line description areas will not be considered for bid evaluation or award.

| INVOICE TO | | SHIP TO | |
|---|----|---|----|
| VARIOUS AGENCY LOCATIONS AS INDICATED BY ORDER | | VARIOUS AGENCY LOCATIONS AS INDICATED BY ORDER | |
| No City | WV | No City | WV |
| US | | US | |

| Line | Comm Ln Desc | Qty | Unit Issue | Unit Price | Total Price |
|------|--------------------------------------|---------|------------|------------|-------------|
| 23 | Surcharge for PG Binder 64H minus 22 | 0.00000 | MILE | | |

| Comm Code | Manufacturer | Specification | Model # |
|-----------|--------------|---------------|---------|
| 12161804 | | | |

Extended Description:

Vendor shall provide bid pricing on the ATT A and ATT B Pricing Pages. Pricing or notations made in wvOASIS commodity line description areas will not be considered for bid evaluation or award.

| INVOICE TO | | SHIP TO | |
|---|----|---|----|
| VARIOUS AGENCY LOCATIONS AS INDICATED BY ORDER | | VARIOUS AGENCY LOCATIONS AS INDICATED BY ORDER | |
| No City | WV | No City | WV |
| US | | US | |

| Line | Comm Ln Desc | Qty | Unit Issue | Unit Price | Total Price |
|------|---|---------|------------|------------|-------------|
| 24 | Surcharge for PG Binder 64E minus 22 (400 Ton increments) | 0.00000 | TON | | |

| Comm Code | Manufacturer | Specification | Model # |
|-----------|--------------|---------------|---------|
| 12161804 | | | |

Extended Description:

Vendor shall provide bid pricing on the ATT A and ATT B Pricing Pages. Pricing or notations made in wvOASIS commodity line description areas will not be considered for bid evaluation or award.

| INVOICE TO | | SHIP TO | |
|---|----|---|----|
| VARIOUS AGENCY LOCATIONS AS INDICATED BY ORDER | | VARIOUS AGENCY LOCATIONS AS INDICATED BY ORDER | |
| No City | WV | No City | WV |
| US | | US | |

| Line | Comm Ln Desc | Qty | Unit Issue | Unit Price | Total Price |
|------|---|---------|------------|------------|-------------|
| 25 | ESAL Surcharge - 3 million to 20 million ESALs | 0.00000 | TON | | |

| Comm Code | Manufacturer | Specification | Model # |
|-----------|--------------|---------------|---------|
| 30121600 | | | |

Extended Description:
Vendor shall provide bid pricing on the ATT A and ATT B Pricing Pages. Pricing or notations made in wvOASIS commodity line description areas will not be considered for bid evaluation or award.

| INVOICE TO | | SHIP TO | |
|---|----|---|----|
| VARIOUS AGENCY LOCATIONS AS INDICATED BY ORDER | | VARIOUS AGENCY LOCATIONS AS INDICATED BY ORDER | |
| No City | WV | No City | WV |
| US | | US | |

| Line | Comm Ln Desc | Qty | Unit Issue | Unit Price | Total Price |
|------|---|---------|------------|------------|-------------|
| 26 | ESAL Surcharge - Greater than 20 million ESALs | 0.00000 | TON | | |

| Comm Code | Manufacturer | Specification | Model # |
|-----------|--------------|---------------|---------|
| 30121600 | | | |

Extended Description:
Vendor shall provide bid pricing on the ATT A and ATT B Pricing Pages. Pricing or notations made in wvOASIS commodity line description areas will not be considered for bid evaluation or award.

| INVOICE TO | | SHIP TO | |
|---|----|---|----|
| VARIOUS AGENCY LOCATIONS AS INDICATED BY ORDER | | VARIOUS AGENCY LOCATIONS AS INDICATED BY ORDER | |
| No City US | WV | No City US | WV |

| Line | Comm Ln Desc | Qty | Unit Issue | Unit Price | Total Price |
|------|---|---------|------------|------------|-------------|
| 27 | Asphalt Haul by Vendor - First Ton Mile | 0.00000 | MILE | | |

| Comm Code | Manufacturer | Specification | Model # |
|-----------|--------------|---------------|---------|
| 78120000 | | | |

Extended Description:

Vendor shall provide bid pricing on the ATT A and ATT B Pricing Pages. Pricing or notations made in wvOASIS commodity line description areas will not be considered for bid evaluation or award.

| INVOICE TO | | SHIP TO | |
|---|----|---|----|
| VARIOUS AGENCY LOCATIONS AS INDICATED BY ORDER | | VARIOUS AGENCY LOCATIONS AS INDICATED BY ORDER | |
| No City US | WV | No City US | WV |

| Line | Comm Ln Desc | Qty | Unit Issue | Unit Price | Total Price |
|------|---|---------|------------|------------|-------------|
| 28 | Asphalt Haul by Vendor - Each Additional Ton Mile | 0.00000 | MILE | | |

| Comm Code | Manufacturer | Specification | Model # |
|-----------|--------------|---------------|---------|
| 78120000 | | | |

Extended Description:

Vendor shall provide bid pricing on the ATT A and ATT B Pricing Pages. Pricing or notations made in wvOASIS commodity line description areas will not be considered for bid evaluation or award.

| INVOICE TO | | SHIP TO | |
|---|----|---|----|
| VARIOUS AGENCY LOCATIONS AS INDICATED BY ORDER | | VARIOUS AGENCY LOCATIONS AS INDICATED BY ORDER | |
| No City | WV | No City | WV |
| US | | US | |

| Line | Comm Ln Desc | Qty | Unit Issue | Unit Price | Total Price |
|------|--|---------|------------|------------|-------------|
| 29 | Laydown of Material Items #1-17, Each Site 0-100 Tons | 0.00000 | TON | | |

| Comm Code | Manufacturer | Specification | Model # |
|-----------|--------------|---------------|---------|
| 72141100 | | | |

Extended Description:
Vendor shall provide bid pricing on the ATT A and ATT B Pricing Pages. Pricing or notations made in wvOASIS commodity line description areas will not be considered for bid evaluation or award.

| INVOICE TO | | SHIP TO | |
|---|----|---|----|
| VARIOUS AGENCY LOCATIONS AS INDICATED BY ORDER | | VARIOUS AGENCY LOCATIONS AS INDICATED BY ORDER | |
| No City | WV | No City | WV |
| US | | US | |

| Line | Comm Ln Desc | Qty | Unit Issue | Unit Price | Total Price |
|------|---|---------|------------|------------|-------------|
| 30 | Laydown of Material Items #1-17, Each Site 101 to 200 Tons | 0.00000 | TON | | |

| Comm Code | Manufacturer | Specification | Model # |
|-----------|--------------|---------------|---------|
| 72141100 | | | |

Extended Description:
Vendor shall provide bid pricing on the ATT A and ATT B Pricing Pages. Pricing or notations made in wvOASIS commodity line description areas will not be considered for bid evaluation or award.

| INVOICE TO | | SHIP TO | |
|---|----|---|----|
| VARIOUS AGENCY LOCATIONS AS INDICATED BY ORDER | | VARIOUS AGENCY LOCATIONS AS INDICATED BY ORDER | |
| No City | WV | No City | WV |
| US | | US | |

| Line | Comm Ln Desc | Qty | Unit Issue | Unit Price | Total Price |
|------|---|---------|------------|------------|-------------|
| 31 | Laydown of Material Items #1-17, Each Site 201 to 500 Tons | 0.00000 | TON | | |

| Comm Code | Manufacturer | Specification | Model # |
|-----------|--------------|---------------|---------|
| 72141100 | | | |

Extended Description:
Vendor shall provide bid pricing on the ATT A and ATT B Pricing Pages. Pricing or notations made in wvOASIS commodity line description areas will not be considered for bid evaluation or award.

| INVOICE TO | | SHIP TO | |
|---|----|---|----|
| VARIOUS AGENCY LOCATIONS AS INDICATED BY ORDER | | VARIOUS AGENCY LOCATIONS AS INDICATED BY ORDER | |
| No City | WV | No City | WV |
| US | | US | |

| Line | Comm Ln Desc | Qty | Unit Issue | Unit Price | Total Price |
|------|---|---------|------------|------------|-------------|
| 32 | Laydown of Material Items #1-17, Each Site 501 Tons or > | 0.00000 | TON | | |

| Comm Code | Manufacturer | Specification | Model # |
|-----------|--------------|---------------|---------|
| 72141100 | | | |

Extended Description:
Vendor shall provide bid pricing on the ATT A and ATT B Pricing Pages. Pricing or notations made in wvOASIS commodity line description areas will not be considered for bid evaluation or award.

| INVOICE TO | | SHIP TO | |
|---|----|---|----|
| VARIOUS AGENCY LOCATIONS AS INDICATED BY ORDER | | VARIOUS AGENCY LOCATIONS AS INDICATED BY ORDER | |
| No City US | WV | No City US | WV |

| Line | Comm Ln Desc | Qty | Unit Issue | Unit Price | Total Price |
|------|---|---------|------------|------------|-------------|
| 33 | Daytime Paving Mobilization (ATT B Pricing Pages) | 0.00000 | LS | | |

| Comm Code | Manufacturer | Specification | Model # |
|-----------|--------------|---------------|---------|
| 24000000 | | | |

Extended Description:
Vendor shall provide bid pricing on the ATT A and ATT B Pricing Pages. Pricing or notations made in wvOASIS commodity line description areas will not be considered for bid evaluation or award.

| INVOICE TO | | SHIP TO | |
|---|----|---|----|
| VARIOUS AGENCY LOCATIONS AS INDICATED BY ORDER | | VARIOUS AGENCY LOCATIONS AS INDICATED BY ORDER | |
| No City US | WV | No City US | WV |

| Line | Comm Ln Desc | Qty | Unit Issue | Unit Price | Total Price |
|------|---|---------|------------|------------|-------------|
| 34 | Nighttime Paving Mobilization (ATT B Pricing Pages) | 0.00000 | LS | | |

| Comm Code | Manufacturer | Specification | Model # |
|-----------|--------------|---------------|---------|
| 24000000 | | | |

Extended Description:
Vendor shall provide bid pricing on the ATT A and ATT B Pricing Pages. Pricing or notations made in wvOASIS commodity line description areas will not be considered for bid evaluation or award.

| INVOICE TO | | SHIP TO | |
|--|----|--|----|
| VARIOUS AGENCY LOCATIONS AS INDICATED BY ORDER | | VARIOUS AGENCY LOCATIONS AS INDICATED BY ORDER | |
| No City | WV | No City | WV |
| US | | US | |

| Line | Comm Ln Desc | Qty | Unit Issue | Unit Price | Total Price |
|------|---|---------|------------|------------|-------------|
| 35 | Excavation for Shoulder Paving - 0 to 1000 SY | 0.00000 | SY | | |

| Comm Code | Manufacturer | Specification | Model # |
|-----------|--------------|---------------|---------|
| 72141505 | | | |

Extended Description:
Vendor shall provide bid pricing on the ATT A and ATT B Pricing Pages. Pricing or notations made in wvOASIS commodity line description areas will not be considered for bid evaluation or award.

| INVOICE TO | | SHIP TO | |
|--|----|--|----|
| VARIOUS AGENCY LOCATIONS AS INDICATED BY ORDER | | VARIOUS AGENCY LOCATIONS AS INDICATED BY ORDER | |
| No City | WV | No City | WV |
| US | | US | |

| Line | Comm Ln Desc | Qty | Unit Issue | Unit Price | Total Price |
|------|--|---------|------------|------------|-------------|
| 36 | Excavation for Shoulder Paving - 1001 to 2000 SY | 0.00000 | SY | | |

| Comm Code | Manufacturer | Specification | Model # |
|-----------|--------------|---------------|---------|
| 72141505 | | | |

Extended Description:
Vendor shall provide bid pricing on the ATT A and ATT B Pricing Pages. Pricing or notations made in wvOASIS commodity line description areas will not be considered for bid evaluation or award.

| INVOICE TO | | SHIP TO | |
|--|----|--|----|
| VARIOUS AGENCY LOCATIONS AS INDICATED BY ORDER | | VARIOUS AGENCY LOCATIONS AS INDICATED BY ORDER | |
| No City | WV | No City | WV |
| US | | US | |

| Line | Comm Ln Desc | Qty | Unit Issue | Unit Price | Total Price |
|------|--|---------|------------|------------|-------------|
| 37 | Excavation for Shoulder Paving - 2001 to 3000 SY | 0.00000 | SY | | |

| Comm Code | Manufacturer | Specification | Model # |
|-----------|--------------|---------------|---------|
| 72141505 | | | |

Extended Description:
Vendor shall provide bid pricing on the ATT A and ATT B Pricing Pages. Pricing or notations made in wvOASIS commodity line description areas will not be considered for bid evaluation or award.

| INVOICE TO | | SHIP TO | |
|--|----|--|----|
| VARIOUS AGENCY LOCATIONS AS INDICATED BY ORDER | | VARIOUS AGENCY LOCATIONS AS INDICATED BY ORDER | |
| No City | WV | No City | WV |
| US | | US | |

| Line | Comm Ln Desc | Qty | Unit Issue | Unit Price | Total Price |
|------|---|---------|------------|------------|-------------|
| 38 | Excavation for Shoulder Paving - 3001 SY or > | 0.00000 | TON | | |

| Comm Code | Manufacturer | Specification | Model # |
|-----------|--------------|---------------|---------|
| 72141505 | | | |

Extended Description:
Vendor shall provide bid pricing on the ATT A and ATT B Pricing Pages. Pricing or notations made in wvOASIS commodity line description areas will not be considered for bid evaluation or award.

| INVOICE TO | | SHIP TO | |
|---|----|---|----|
| VARIOUS AGENCY LOCATIONS AS INDICATED BY ORDER | | VARIOUS AGENCY LOCATIONS AS INDICATED BY ORDER | |
| No City | WV | No City | WV |
| US | | US | |

| Line | Comm Ln Desc | Qty | Unit Issue | Unit Price | Total Price |
|------|--|---------|------------|------------|-------------|
| 39 | Asphalt Base I Shoulder Paving Surcharge - 0 to 100 Tons | 0.00000 | TON | | |

| Comm Code | Manufacturer | Specification | Model # |
|-----------|--------------|---------------|---------|
| 72141100 | | | |

Extended Description:

Vendor shall provide bid pricing on the ATT A and ATT B Pricing Pages. Pricing or notations made in wvOASIS commodity line description areas will not be considered for bid evaluation or award.

| INVOICE TO | | SHIP TO | |
|---|----|---|----|
| VARIOUS AGENCY LOCATIONS AS INDICATED BY ORDER | | VARIOUS AGENCY LOCATIONS AS INDICATED BY ORDER | |
| No City | WV | No City | WV |
| US | | US | |

| Line | Comm Ln Desc | Qty | Unit Issue | Unit Price | Total Price |
|------|--|---------|------------|------------|-------------|
| 40 | Asphalt Base I Shoulder Paving Surcharge - 101 to 200 Tons | 0.00000 | TON | | |

| Comm Code | Manufacturer | Specification | Model # |
|-----------|--------------|---------------|---------|
| 72141100 | | | |

Extended Description:

Vendor shall provide bid pricing on the ATT A and ATT B Pricing Pages. Pricing or notations made in wvOASIS commodity line description areas will not be considered for bid evaluation or award.

| INVOICE TO | | SHIP TO | |
|--|----|--|----|
| VARIOUS AGENCY LOCATIONS AS INDICATED BY ORDER | | VARIOUS AGENCY LOCATIONS AS INDICATED BY ORDER | |
| No City | WV | No City | WV |
| US | | US | |

| Line | Comm Ln Desc | Qty | Unit Issue | Unit Price | Total Price |
|------|---|---------|------------|------------|-------------|
| 41 | Asphalt Base I Shoulder Paving Surcharge - 201 to 500 Tons | 0.00000 | TON | | |

| Comm Code | Manufacturer | Specification | Model # |
|-----------|--------------|---------------|---------|
| 72141100 | | | |

Extended Description:

Vendor shall provide bid pricing on the ATT A and ATT B Pricing Pages. Pricing or notations made in wvOASIS commodity line description areas will not be considered for bid evaluation or award.

| INVOICE TO | | SHIP TO | |
|--|----|--|----|
| VARIOUS AGENCY LOCATIONS AS INDICATED BY ORDER | | VARIOUS AGENCY LOCATIONS AS INDICATED BY ORDER | |
| No City | WV | No City | WV |
| US | | US | |

| Line | Comm Ln Desc | Qty | Unit Issue | Unit Price | Total Price |
|------|---|---------|------------|------------|-------------|
| 42 | Asphalt Base I Shoulder Paving Surcharge - 501 Tons or > | 0.00000 | TON | | |

| Comm Code | Manufacturer | Specification | Model # |
|-----------|--------------|---------------|---------|
| 72141100 | | | |

Extended Description:

Vendor shall provide bid pricing on the ATT A and ATT B Pricing Pages. Pricing or notations made in wvOASIS commodity line description areas will not be considered for bid evaluation or award.

| INVOICE TO | | SHIP TO | |
|---|----|---|----|
| VARIOUS AGENCY LOCATIONS AS INDICATED BY ORDER | | VARIOUS AGENCY LOCATIONS AS INDICATED BY ORDER | |
| No City US | WV | No City US | WV |

| Line | Comm Ln Desc | Qty | Unit Issue | Unit Price | Total Price |
|------|--|---------|------------|------------|-------------|
| 43 | Asphalt Base II Shoulder Paving Surcharge - 0 to 100 Tons | 0.00000 | TON | | |

| Comm Code | Manufacturer | Specification | Model # |
|-----------|--------------|---------------|---------|
| 72141100 | | | |

Extended Description:

Vendor shall provide bid pricing on the ATT A and ATT B Pricing Pages. Pricing or notations made in wvOASIS commodity line description areas will not be considered for bid evaluation or award.

| INVOICE TO | | SHIP TO | |
|---|----|---|----|
| VARIOUS AGENCY LOCATIONS AS INDICATED BY ORDER | | VARIOUS AGENCY LOCATIONS AS INDICATED BY ORDER | |
| No City US | WV | No City US | WV |

| Line | Comm Ln Desc | Qty | Unit Issue | Unit Price | Total Price |
|------|--|---------|------------|------------|-------------|
| 44 | Asphalt Base II Shoulder Paving Surcharge - 101 to 200 Tons | 0.00000 | TON | | |

| Comm Code | Manufacturer | Specification | Model # |
|-----------|--------------|---------------|---------|
| 72141100 | | | |

Extended Description:

Vendor shall provide bid pricing on the ATT A and ATT B Pricing Pages. Pricing or notations made in wvOASIS commodity line description areas will not be considered for bid evaluation or award.

| INVOICE TO | | SHIP TO | |
|--|----|--|----|
| VARIOUS AGENCY LOCATIONS AS INDICATED BY ORDER | | VARIOUS AGENCY LOCATIONS AS INDICATED BY ORDER | |
| No City | WV | No City | WV |
| US | | US | |

| Line | Comm Ln Desc | Qty | Unit Issue | Unit Price | Total Price |
|------|--|---------|------------|------------|-------------|
| 45 | Asphalt Base II Shoulder Paving Surcharge - 201 to 500 Tons | 0.00000 | TON | | |

| Comm Code | Manufacturer | Specification | Model # |
|-----------|--------------|---------------|---------|
| 72141100 | | | |

Extended Description:

Vendor shall provide bid pricing on the ATT A and ATT B Pricing Pages. Pricing or notations made in wvOASIS commodity line description areas will not be considered for bid evaluation or award.

| INVOICE TO | | SHIP TO | |
|--|----|--|----|
| VARIOUS AGENCY LOCATIONS AS INDICATED BY ORDER | | VARIOUS AGENCY LOCATIONS AS INDICATED BY ORDER | |
| No City | WV | No City | WV |
| US | | US | |

| Line | Comm Ln Desc | Qty | Unit Issue | Unit Price | Total Price |
|------|---|---------|------------|------------|-------------|
| 46 | Asphalt Base II Shoulder Paving Surcharge- 501 TN or > | 0.00000 | TON | | |

| Comm Code | Manufacturer | Specification | Model # |
|-----------|--------------|---------------|---------|
| 72141100 | | | |

Extended Description:

Vendor shall provide bid pricing on the ATT A and ATT B Pricing Pages. Pricing or notations made in wvOASIS commodity line description areas will not be considered for bid evaluation or award.

| INVOICE TO | | SHIP TO | |
|--|----|--|----|
| VARIOUS AGENCY LOCATIONS AS INDICATED BY ORDER | | VARIOUS AGENCY LOCATIONS AS INDICATED BY ORDER | |
| No City | WV | No City | WV |
| US | | US | |

| Line | Comm Ln Desc | Qty | Unit Issue | Unit Price | Total Price |
|------|--------------------------------|---------|------------|------------|-------------|
| 47 | Asphalt Material for Tack Coat | 0.00000 | GL | | |

| Comm Code | Manufacturer | Specification | Model # |
|-----------|--------------|---------------|---------|
| 12161804 | | | |

Extended Description:

Vendor shall provide bid pricing on the ATT A and ATT B Pricing Pages. Pricing or notations made in wvOASIS commodity line description areas will not be considered for bid evaluation or award.

| INVOICE TO | | SHIP TO | |
|--|----|--|----|
| VARIOUS AGENCY LOCATIONS AS INDICATED BY ORDER | | VARIOUS AGENCY LOCATIONS AS INDICATED BY ORDER | |
| No City | WV | No City | WV |
| US | | US | |

| Line | Comm Ln Desc | Qty | Unit Issue | Unit Price | Total Price |
|------|---------------------------|---------|------------|------------|-------------|
| 48 | Additional Heel-In Joints | 0.00000 | LF | | |

| Comm Code | Manufacturer | Specification | Model # |
|-----------|--------------|---------------|---------|
| 72141100 | | | |

Extended Description:

Vendor shall provide bid pricing on the ATT A and ATT B Pricing Pages. Pricing or notations made in wvOASIS commodity line description areas will not be considered for bid evaluation or award.

| INVOICE TO | | SHIP TO | |
|---|----|---|----|
| VARIOUS AGENCY LOCATIONS AS INDICATED BY ORDER | | VARIOUS AGENCY LOCATIONS AS INDICATED BY ORDER | |
| No City US | WV | No City US | WV |

| Line | Comm Ln Desc | Qty | Unit Issue | Unit Price | Total Price |
|------|-----------------------|---------|------------|------------|-------------|
| 49 | Skip Paving Surcharge | 0.00000 | TON | | |

| Comm Code | Manufacturer | Specification | Model # |
|-----------|--------------|---------------|---------|
| 72141100 | | | |

Extended Description:
Vendor shall provide bid pricing on the ATT A and ATT B Pricing Pages. Pricing or notations made in wvOASIS commodity line description areas will not be considered for bid evaluation or award.

| INVOICE TO | | SHIP TO | |
|---|----|---|----|
| VARIOUS AGENCY LOCATIONS AS INDICATED BY ORDER | | VARIOUS AGENCY LOCATIONS AS INDICATED BY ORDER | |
| No City US | WV | No City US | WV |

| Line | Comm Ln Desc | Qty | Unit Issue | Unit Price | Total Price |
|------|---|---------|------------|------------|-------------|
| 50 | Pavement Profiling/Milling-WVDOH Owns Millings 0-250 SY | 0.00000 | SY | | |

| Comm Code | Manufacturer | Specification | Model # |
|-----------|--------------|---------------|---------|
| 72141100 | | | |

Extended Description:
Vendor shall provide bid pricing on the ATT A and ATT B Pricing Pages. Pricing or notations made in wvOASIS commodity line description areas will not be considered for bid evaluation or award.

| INVOICE TO | | SHIP TO | |
|---|----|---|----|
| VARIOUS AGENCY LOCATIONS AS INDICATED BY ORDER | | VARIOUS AGENCY LOCATIONS AS INDICATED BY ORDER | |
| No City | WV | No City | WV |
| US | | US | |

| Line | Comm Ln Desc | Qty | Unit Issue | Unit Price | Total Price |
|------|---|---------|------------|------------|-------------|
| 51 | Pavement Profiling/Milling-WVDOH Owns Millings 251-500 SY | 0.00000 | SY | | |

| Comm Code | Manufacturer | Specification | Model # |
|-----------|--------------|---------------|---------|
| 72141100 | | | |

Extended Description:

Vendor shall provide bid pricing on the ATT A and ATT B Pricing Pages. Pricing or notations made in wvOASIS commodity line description areas will not be considered for bid evaluation or award.

| INVOICE TO | | SHIP TO | |
|---|----|---|----|
| VARIOUS AGENCY LOCATIONS AS INDICATED BY ORDER | | VARIOUS AGENCY LOCATIONS AS INDICATED BY ORDER | |
| No City | WV | No City | WV |
| US | | US | |

| Line | Comm Ln Desc | Qty | Unit Issue | Unit Price | Total Price |
|------|--|---------|------------|------------|-------------|
| 52 | Pavement Profiling/Milling-WVDOH Owns Millings 501-1000 SY | 0.00000 | SY | | |

| Comm Code | Manufacturer | Specification | Model # |
|-----------|--------------|---------------|---------|
| 72141100 | | | |

Extended Description:

Vendor shall provide bid pricing on the ATT A and ATT B Pricing Pages. Pricing or notations made in wvOASIS commodity line description areas will not be considered for bid evaluation or award.

| INVOICE TO | | SHIP TO | |
|---|----|---|----|
| VARIOUS AGENCY LOCATIONS AS INDICATED BY ORDER | | VARIOUS AGENCY LOCATIONS AS INDICATED BY ORDER | |
| No City | WV | No City | WV |
| US | | US | |

| Line | Comm Ln Desc | Qty | Unit Issue | Unit Price | Total Price |
|------|---|---------|------------|------------|-------------|
| 53 | Pavement Profiling/Milling-WVDOH Owns Millings 1001-2500 SY | 0.00000 | SY | | |

| Comm Code | Manufacturer | Specification | Model # |
|-----------|--------------|---------------|---------|
| 72141100 | | | |

Extended Description:

Vendor shall provide bid pricing on the ATT A and ATT B Pricing Pages. Pricing or notations made in wvOASIS commodity line description areas will not be considered for bid evaluation or award.

| INVOICE TO | | SHIP TO | |
|---|----|---|----|
| VARIOUS AGENCY LOCATIONS AS INDICATED BY ORDER | | VARIOUS AGENCY LOCATIONS AS INDICATED BY ORDER | |
| No City | WV | No City | WV |
| US | | US | |

| Line | Comm Ln Desc | Qty | Unit Issue | Unit Price | Total Price |
|------|---|---------|------------|------------|-------------|
| 54 | Pavement Profiling/Milling-WVDOH Owns Millings 2501-5000 SY | 0.00000 | SY | | |

| Comm Code | Manufacturer | Specification | Model # |
|-----------|--------------|---------------|---------|
| 72141100 | | | |

Extended Description:

Vendor shall provide bid pricing on the ATT A and ATT B Pricing Pages. Pricing or notations made in wvOASIS commodity line description areas will not be considered for bid evaluation or award.

| INVOICE TO | | SHIP TO | |
|---|----|---|----|
| VARIOUS AGENCY LOCATIONS AS INDICATED BY ORDER | | VARIOUS AGENCY LOCATIONS AS INDICATED BY ORDER | |
| No City | WV | No City | WV |
| US | | US | |

| Line | Comm Ln Desc | Qty | Unit Issue | Unit Price | Total Price |
|------|---|---------|------------|------------|-------------|
| 55 | Pavement Profiling/Milling-WVDOH Owns Millings 5001 SY or > | 0.00000 | SY | | |

| Comm Code | Manufacturer | Specification | Model # |
|-----------|--------------|---------------|---------|
| 72141100 | | | |

Extended Description:
Vendor shall provide bid pricing on the ATT A and ATT B Pricing Pages. Pricing or notations made in wvOASIS commodity line description areas will not be considered for bid evaluation or award.

| INVOICE TO | | SHIP TO | |
|---|----|---|----|
| VARIOUS AGENCY LOCATIONS AS INDICATED BY ORDER | | VARIOUS AGENCY LOCATIONS AS INDICATED BY ORDER | |
| No City | WV | No City | WV |
| US | | US | |

| Line | Comm Ln Desc | Qty | Unit Issue | Unit Price | Total Price |
|------|---|---------|------------|------------|-------------|
| 56 | Pavement Profiling/Milling-Vendor Owns Millings 0 to 250 SY | 0.00000 | SY | | |

| Comm Code | Manufacturer | Specification | Model # |
|-----------|--------------|---------------|---------|
| 72141100 | | | |

Extended Description:
Vendor shall provide bid pricing on the ATT A and ATT B Pricing Pages. Pricing or notations made in wvOASIS commodity line description areas will not be considered for bid evaluation or award.

| INVOICE TO | | SHIP TO | |
|---|----|---|----|
| VARIOUS AGENCY LOCATIONS AS INDICATED BY ORDER | | VARIOUS AGENCY LOCATIONS AS INDICATED BY ORDER | |
| No City US | WV | No City US | WV |

| Line | Comm Ln Desc | Qty | Unit Issue | Unit Price | Total Price |
|------|--|---------|------------|------------|-------------|
| 57 | Pavement Profiling/Milling-Vendor Owns Millings 251-500 SY | 0.00000 | SY | | |

| Comm Code | Manufacturer | Specification | Model # |
|-----------|--------------|---------------|---------|
| 12161804 | | | |

Extended Description:

Vendor shall provide bid pricing on the ATT A and ATT B Pricing Pages. Pricing or notations made in wvOASIS commodity line description areas will not be considered for bid evaluation or award.

| INVOICE TO | | SHIP TO | |
|---|----|---|----|
| VARIOUS AGENCY LOCATIONS AS INDICATED BY ORDER | | VARIOUS AGENCY LOCATIONS AS INDICATED BY ORDER | |
| No City US | WV | No City US | WV |

| Line | Comm Ln Desc | Qty | Unit Issue | Unit Price | Total Price |
|------|---|---------|------------|------------|-------------|
| 58 | Pavement Profiling/Milling-Vendor Owns Millings 501-1000 SY | 0.00000 | SY | | |

| Comm Code | Manufacturer | Specification | Model # |
|-----------|--------------|---------------|---------|
| 72141100 | | | |

Extended Description:

Vendor shall provide bid pricing on the ATT A and ATT B Pricing Pages. Pricing or notations made in wvOASIS commodity line description areas will not be considered for bid evaluation or award.

| INVOICE TO | | SHIP TO | |
|---|----|---|----|
| VARIOUS AGENCY LOCATIONS AS INDICATED BY ORDER | | VARIOUS AGENCY LOCATIONS AS INDICATED BY ORDER | |
| No City US | WV | No City US | WV |

| Line | Comm Ln Desc | Qty | Unit Issue | Unit Price | Total Price |
|------|--|---------|------------|------------|-------------|
| 59 | Pavement Profiling/Milling-Vendor Owns Millings 1001-2500 SY | 0.00000 | SY | | |

| Comm Code | Manufacturer | Specification | Model # |
|-----------|--------------|---------------|---------|
| 72141100 | | | |

Extended Description:
Vendor shall provide bid pricing on the ATT A and ATT B Pricing Pages. Pricing or notations made in wvOASIS commodity line description areas will not be considered for bid evaluation or award.

| INVOICE TO | | SHIP TO | |
|---|----|---|----|
| VARIOUS AGENCY LOCATIONS AS INDICATED BY ORDER | | VARIOUS AGENCY LOCATIONS AS INDICATED BY ORDER | |
| No City US | WV | No City US | WV |

| Line | Comm Ln Desc | Qty | Unit Issue | Unit Price | Total Price |
|------|--|---------|------------|------------|-------------|
| 60 | Pavement Profiling/Milling-Vendor Owns Millings 2501-5000 SY | 0.00000 | SY | | |

| Comm Code | Manufacturer | Specification | Model # |
|-----------|--------------|---------------|---------|
| 72141100 | | | |

Extended Description:
Vendor shall provide bid pricing on the ATT A and ATT B Pricing Pages. Pricing or notations made in wvOASIS commodity line description areas will not be considered for bid evaluation or award.

| INVOICE TO | | SHIP TO | |
|---|----|---|----|
| VARIOUS AGENCY LOCATIONS AS INDICATED BY ORDER | | VARIOUS AGENCY LOCATIONS AS INDICATED BY ORDER | |
| No City US | WV | No City US | WV |

| Line | Comm Ln Desc | Qty | Unit Issue | Unit Price | Total Price |
|------|--|---------|------------|------------|-------------|
| 61 | Pavement Profiling/Milling-Vendor Owns Millings 5001 SY or > | 0.00000 | SY | | |

| Comm Code | Manufacturer | Specification | Model # |
|-----------|--------------|---------------|---------|
| 72141100 | | | |

Extended Description:

Vendor shall provide bid pricing on the ATT A and ATT B Pricing Pages. Pricing or notations made in wvOASIS commodity line description areas will not be considered for bid evaluation or award.

| INVOICE TO | | SHIP TO | |
|---|----|---|----|
| VARIOUS AGENCY LOCATIONS AS INDICATED BY ORDER | | VARIOUS AGENCY LOCATIONS AS INDICATED BY ORDER | |
| No City US | WV | No City US | WV |

| Line | Comm Ln Desc | Qty | Unit Issue | Unit Price | Total Price |
|------|--|---------|------------|------------|-------------|
| 62 | Pavement Profiling/Milling Mobilization (ATT B Pricing Page) | 0.00000 | LS | | |

| Comm Code | Manufacturer | Specification | Model # |
|-----------|--------------|---------------|---------|
| 24000000 | | | |

Extended Description:

Vendor shall provide bid pricing on the ATT A and ATT B Pricing Pages. Pricing or notations made in wvOASIS commodity line description areas will not be considered for bid evaluation or award.

| INVOICE TO | SHIP TO |
|------------|---------|
|------------|---------|

| | |
|--|--|
| VARIOUS AGENCY LOCATIONS AS INDICATED BY ORDER | VARIOUS AGENCY LOCATIONS AS INDICATED BY ORDER |
|--|--|

| | | | |
|---------|----|---------|----|
| No City | WV | No City | WV |
| US | | US | |

| Line | Comm Ln Desc | Qty | Unit Issue | Unit Price | Total Price |
|------|---|---------|------------|------------|-------------|
| 63 | Haul of Profiled/Milled Cuttings or Fine Millings-1st 10 mi | 0.00000 | MILE | | |

| Comm Code | Manufacturer | Specification | Model # |
|-----------|--------------|---------------|---------|
| 78120000 | | | |

Extended Description:

Haul of Profiled/Milled Cuttings or Fine Millings, First 10 Miles
 (Included with #50-61 and #70-81)

Vendor shall provide bid pricing on the ATT A and ATT B Pricing Pages. Pricing or notations made in wvOASIS commodity line description areas will not be considered for bid evaluation or award.

| INVOICE TO | SHIP TO |
|------------|---------|
|------------|---------|

| | |
|--|--|
| VARIOUS AGENCY LOCATIONS AS INDICATED BY ORDER | VARIOUS AGENCY LOCATIONS AS INDICATED BY ORDER |
|--|--|

| | | | |
|---------|----|---------|----|
| No City | WV | No City | WV |
| US | | US | |

| Line | Comm Ln Desc | Qty | Unit Issue | Unit Price | Total Price |
|------|--|---------|------------|------------|-------------|
| 64 | Haul of Profiled/Milled Cuttings or Fine Millings-Add'l Mile | 0.00000 | MILE | | |

| Comm Code | Manufacturer | Specification | Model # |
|-----------|--------------|---------------|---------|
| 78120000 | | | |

Extended Description:

Haul of Profiled/Milled Cuttings or Fine Millings (each additional Ton Mile after 10 miles)

Vendor shall provide bid pricing on the ATT A and ATT B Pricing Pages. Pricing or notations made in wvOASIS commodity line description areas will not be considered for bid evaluation or award.

| INVOICE TO | | SHIP TO | |
|---|----|---|----|
| VARIOUS AGENCY LOCATIONS AS INDICATED BY ORDER | | VARIOUS AGENCY LOCATIONS AS INDICATED BY ORDER | |
| No City | WV | No City | WV |
| US | | US | |

| Line | Comm Ln Desc | Qty | Unit Issue | Unit Price | Total Price |
|------|---------------------------------|---------|------------|------------|-------------|
| 65 | Pavement Repair-Asphalt Base II | 0.00000 | SY | | |

| Comm Code | Manufacturer | Specification | Model # |
|-----------|--------------|---------------|---------|
| 72141100 | | | |

Extended Description:
 Vendor shall provide bid pricing on the ATT A and ATT B Pricing Pages. Pricing or notations made in wvOASIS commodity line description areas will not be considered for bid evaluation or award.

| INVOICE TO | | SHIP TO | |
|---|----|---|----|
| VARIOUS AGENCY LOCATIONS AS INDICATED BY ORDER | | VARIOUS AGENCY LOCATIONS AS INDICATED BY ORDER | |
| No City | WV | No City | WV |
| US | | US | |

| Line | Comm Ln Desc | Qty | Unit Issue | Unit Price | Total Price |
|------|---|---------|------------|------------|-------------|
| 66 | Asphalt HPTO - SP496 - PG 64E-22 (400 Ton increments) | 0.00000 | TON | | |

| Comm Code | Manufacturer | Specification | Model # |
|-----------|--------------|---------------|---------|
| 30121600 | | | |

Extended Description:
 Vendor shall provide bid pricing on the ATT A and ATT B Pricing Pages. Pricing or notations made in wvOASIS commodity line description areas will not be considered for bid evaluation or award.

| INVOICE TO | | SHIP TO | |
|---|----|---|----|
| VARIOUS AGENCY LOCATIONS AS INDICATED BY ORDER | | VARIOUS AGENCY LOCATIONS AS INDICATED BY ORDER | |
| No City | WV | No City | WV |
| US | | US | |

| Line | Comm Ln Desc | Qty | Unit Issue | Unit Price | Total Price |
|------|-------------------|---------|------------|------------|-------------|
| 67 | Non-Tracking Tack | 0.00000 | GL | | |

| Comm Code | Manufacturer | Specification | Model # |
|-----------|--------------|---------------|---------|
| 12161804 | | | |

Extended Description:
Vendor shall provide bid pricing on the ATT A and ATT B Pricing Pages. Pricing or notations made in wvOASIS commodity line description areas will not be considered for bid evaluation or award.

| INVOICE TO | | SHIP TO | |
|---|----|---|----|
| VARIOUS AGENCY LOCATIONS AS INDICATED BY ORDER | | VARIOUS AGENCY LOCATIONS AS INDICATED BY ORDER | |
| No City | WV | No City | WV |
| US | | US | |

| Line | Comm Ln Desc | Qty | Unit Issue | Unit Price | Total Price |
|------|---|---------|------------|------------|-------------|
| 68 | Lay Down of Materials - to be used with #65 - 400 Ton or > | 0.00000 | TON | | |

| Comm Code | Manufacturer | Specification | Model # |
|-----------|--------------|---------------|---------|
| 72141100 | | | |

Extended Description:
Vendor shall provide bid pricing on the ATT A and ATT B Pricing Pages. Pricing or notations made in wvOASIS commodity line description areas will not be considered for bid evaluation or award.

| INVOICE TO | | SHIP TO | |
|---|----|---|----|
| VARIOUS AGENCY LOCATIONS AS INDICATED BY ORDER | | VARIOUS AGENCY LOCATIONS AS INDICATED BY ORDER | |
| No City | WV | No City | WV |
| US | | US | |

| Line | Comm Ln Desc | Qty | Unit Issue | Unit Price | Total Price |
|------|------------------------------------|---------|------------|------------|-------------|
| 69 | Ultra-Thin Asphalt Overlay - SP498 | 0.00000 | TON | | |

| Comm Code | Manufacturer | Specification | Model # |
|-----------|--------------|---------------|---------|
| 30121600 | | | |

Extended Description:

Vendor shall provide bid pricing on the ATT A and ATT B Pricing Pages. Pricing or notations made in wvOASIS commodity line description areas will not be considered for bid evaluation or award.

| INVOICE TO | | SHIP TO | |
|---|----|---|----|
| VARIOUS AGENCY LOCATIONS AS INDICATED BY ORDER | | VARIOUS AGENCY LOCATIONS AS INDICATED BY ORDER | |
| No City | WV | No City | WV |
| US | | US | |

| Line | Comm Ln Desc | Qty | Unit Issue | Unit Price | Total Price |
|------|--|---------|------------|------------|-------------|
| 70 | Fine Milling -WVDOH Owns Millings 0-250 SY | 0.00000 | SY | | |

| Comm Code | Manufacturer | Specification | Model # |
|-----------|--------------|---------------|---------|
| 73181021 | | | |

Extended Description:

Vendor shall provide bid pricing on the ATT A and ATT B Pricing Pages. Pricing or notations made in wvOASIS commodity line description areas will not be considered for bid evaluation or award.

| INVOICE TO | | SHIP TO | |
|---|----|---|----|
| VARIOUS AGENCY LOCATIONS AS INDICATED BY ORDER | | VARIOUS AGENCY LOCATIONS AS INDICATED BY ORDER | |
| No City | WV | No City | WV |
| US | | US | |

| Line | Comm Ln Desc | Qty | Unit Issue | Unit Price | Total Price |
|------|---|---------|------------|------------|-------------|
| 71 | Fine Milling -WVDOH Owns Millings 251-500 SY | 0.00000 | SY | | |

| Comm Code | Manufacturer | Specification | Model # |
|-----------|--------------|---------------|---------|
| 73181021 | | | |

Extended Description:
Vendor shall provide bid pricing on the ATT A and ATT B Pricing Pages. Pricing or notations made in wvOASIS commodity line description areas will not be considered for bid evaluation or award.

| INVOICE TO | | SHIP TO | |
|---|----|---|----|
| VARIOUS AGENCY LOCATIONS AS INDICATED BY ORDER | | VARIOUS AGENCY LOCATIONS AS INDICATED BY ORDER | |
| No City | WV | No City | WV |
| US | | US | |

| Line | Comm Ln Desc | Qty | Unit Issue | Unit Price | Total Price |
|------|--|---------|------------|------------|-------------|
| 72 | Fine Milling -WVDOH Owns Millings 501-1000 SY | 0.00000 | SY | | |

| Comm Code | Manufacturer | Specification | Model # |
|-----------|--------------|---------------|---------|
| 73181021 | | | |

Extended Description:
Vendor shall provide bid pricing on the ATT A and ATT B Pricing Pages. Pricing or notations made in wvOASIS commodity line description areas will not be considered for bid evaluation or award.

| INVOICE TO | | SHIP TO | |
|---|----|---|----|
| VARIOUS AGENCY LOCATIONS AS INDICATED BY ORDER | | VARIOUS AGENCY LOCATIONS AS INDICATED BY ORDER | |
| No City | WV | No City | WV |
| US | | US | |

| Line | Comm Ln Desc | Qty | Unit Issue | Unit Price | Total Price |
|------|---|---------|------------|------------|-------------|
| 73 | Fine Milling -WVDOH Owns Millings 1,001-2,500 SY | 0.00000 | SY | | |

| Comm Code | Manufacturer | Specification | Model # |
|-----------|--------------|---------------|---------|
| 73181021 | | | |

Extended Description:

Vendor shall provide bid pricing on the ATT A and ATT B Pricing Pages. Pricing or notations made in wvOASIS commodity line description areas will not be considered for bid evaluation or award.

| INVOICE TO | | SHIP TO | |
|---|----|---|----|
| VARIOUS AGENCY LOCATIONS AS INDICATED BY ORDER | | VARIOUS AGENCY LOCATIONS AS INDICATED BY ORDER | |
| No City | WV | No City | WV |
| US | | US | |

| Line | Comm Ln Desc | Qty | Unit Issue | Unit Price | Total Price |
|------|---|---------|------------|------------|-------------|
| 74 | Fine Milling -WVDOH Owns Millings 2,501 to 5,000 Sq. Yards | 0.00000 | SY | | |

| Comm Code | Manufacturer | Specification | Model # |
|-----------|--------------|---------------|---------|
| 73181021 | | | |

Extended Description:

Vendor shall provide bid pricing on the ATT A and ATT B Pricing Pages. Pricing or notations made in wvOASIS commodity line description areas will not be considered for bid evaluation or award.

| INVOICE TO | | SHIP TO | |
|---|----|---|----|
| VARIOUS AGENCY LOCATIONS AS INDICATED BY ORDER | | VARIOUS AGENCY LOCATIONS AS INDICATED BY ORDER | |
| No City | WV | No City | WV |
| US | | US | |

| Line | Comm Ln Desc | Qty | Unit Issue | Unit Price | Total Price |
|------|--|---------|------------|------------|-------------|
| 75 | Fine Milling -WVDOH Owns Millings 5,001 SY or > | 0.00000 | SY | | |

| Comm Code | Manufacturer | Specification | Model # |
|-----------|--------------|---------------|---------|
| 73181021 | | | |

Extended Description:
Vendor shall provide bid pricing on the ATT A and ATT B Pricing Pages. Pricing or notations made in wvOASIS commodity line description areas will not be considered for bid evaluation or award.

| INVOICE TO | | SHIP TO | |
|---|----|---|----|
| VARIOUS AGENCY LOCATIONS AS INDICATED BY ORDER | | VARIOUS AGENCY LOCATIONS AS INDICATED BY ORDER | |
| No City | WV | No City | WV |
| US | | US | |

| Line | Comm Ln Desc | Qty | Unit Issue | Unit Price | Total Price |
|------|--|---------|------------|------------|-------------|
| 76 | Fine Milling- Vendor Owns Millings 0 -250 SY | 0.00000 | SY | | |

| Comm Code | Manufacturer | Specification | Model # |
|-----------|--------------|---------------|---------|
| 73181021 | | | |

Extended Description:
Vendor shall provide bid pricing on the ATT A and ATT B Pricing Pages. Pricing or notations made in wvOASIS commodity line description areas will not be considered for bid evaluation or award.

| INVOICE TO | | SHIP TO | |
|---|----|---|----|
| VARIOUS AGENCY LOCATIONS AS INDICATED BY ORDER | | VARIOUS AGENCY LOCATIONS AS INDICATED BY ORDER | |
| No City | WV | No City | WV |
| US | | US | |

| Line | Comm Ln Desc | Qty | Unit Issue | Unit Price | Total Price |
|------|---|---------|------------|------------|-------------|
| 77 | Fine Milling- Vendor Owns Millings 251-500 SY | 0.00000 | SY | | |

| Comm Code | Manufacturer | Specification | Model # |
|-----------|--------------|---------------|---------|
| 73181021 | | | |

Extended Description:
Vendor shall provide bid pricing on the ATT A and ATT B Pricing Pages. Pricing or notations made in wvOASIS commodity line description areas will not be considered for bid evaluation or award.

| INVOICE TO | | SHIP TO | |
|---|----|---|----|
| VARIOUS AGENCY LOCATIONS AS INDICATED BY ORDER | | VARIOUS AGENCY LOCATIONS AS INDICATED BY ORDER | |
| No City | WV | No City | WV |
| US | | US | |

| Line | Comm Ln Desc | Qty | Unit Issue | Unit Price | Total Price |
|------|---|---------|------------|------------|-------------|
| 78 | Fine Milling- Vendor Owns Millings 501 to 1,000 Sq. Yards | 0.00000 | SY | | |

| Comm Code | Manufacturer | Specification | Model # |
|-----------|--------------|---------------|---------|
| 73181021 | | | |

Extended Description:
Vendor shall provide bid pricing on the ATT A and ATT B Pricing Pages. Pricing or notations made in wvOASIS commodity line description areas will not be considered for bid evaluation or award.

| INVOICE TO | | SHIP TO | |
|---|----|---|----|
| VARIOUS AGENCY LOCATIONS AS INDICATED BY ORDER | | VARIOUS AGENCY LOCATIONS AS INDICATED BY ORDER | |
| No City | WV | No City | WV |
| US | | US | |

| Line | Comm Ln Desc | Qty | Unit Issue | Unit Price | Total Price |
|------|---|---------|------------|------------|-------------|
| 79 | Fine Milling- Vendor Owns Millings 1,001-2,500 SY | 0.00000 | SY | | |

| Comm Code | Manufacturer | Specification | Model # |
|-----------|--------------|---------------|---------|
| 73181021 | | | |

Extended Description:

Vendor shall provide bid pricing on the ATT A and ATT B Pricing Pages. Pricing or notations made in wvOASIS commodity line description areas will not be considered for bid evaluation or award.

| INVOICE TO | | SHIP TO | |
|---|----|---|----|
| VARIOUS AGENCY LOCATIONS AS INDICATED BY ORDER | | VARIOUS AGENCY LOCATIONS AS INDICATED BY ORDER | |
| No City | WV | No City | WV |
| US | | US | |

| Line | Comm Ln Desc | Qty | Unit Issue | Unit Price | Total Price |
|------|---|---------|------------|------------|-------------|
| 80 | Fine Milling- Vendor Owns Millings 2,501-5,000 SY | 0.00000 | SY | | |

| Comm Code | Manufacturer | Specification | Model # |
|-----------|--------------|---------------|---------|
| 73181021 | | | |

Extended Description:

Vendor shall provide bid pricing on the ATT A and ATT B Pricing Pages. Pricing or notations made in wvOASIS commodity line description areas will not be considered for bid evaluation or award.

| INVOICE TO | | SHIP TO | |
|---|----|---|----|
| VARIOUS AGENCY LOCATIONS AS INDICATED BY ORDER | | VARIOUS AGENCY LOCATIONS AS INDICATED BY ORDER | |
| No City | WV | No City | WV |
| US | | US | |

| Line | Comm Ln Desc | Qty | Unit Issue | Unit Price | Total Price |
|------|---|---------|------------|------------|-------------|
| 81 | Fine Milling- Vendor Owns Millings 5,001 or > | 0.00000 | SY | | |

| Comm Code | Manufacturer | Specification | Model # |
|-----------|--------------|---------------|---------|
| 73181021 | | | |

Extended Description:
Vendor shall provide bid pricing on the ATT A and ATT B Pricing Pages. Pricing or notations made in wvOASIS commodity line description areas will not be considered for bid evaluation or award.

| INVOICE TO | | SHIP TO | |
|---|----|---|----|
| VARIOUS AGENCY LOCATIONS AS INDICATED BY ORDER | | VARIOUS AGENCY LOCATIONS AS INDICATED BY ORDER | |
| No City | WV | No City | WV |
| US | | US | |

| Line | Comm Ln Desc | Qty | Unit Issue | Unit Price | Total Price |
|------|----------------------|---------|------------|------------|-------------|
| 82 | Milled Rumble Strips | 0.00000 | LF | | |

| Comm Code | Manufacturer | Specification | Model # |
|-----------|--------------|---------------|---------|
| 73181021 | | | |

Extended Description:
Vendor shall provide bid pricing on the ATT A and ATT B Pricing Pages. Pricing or notations made in wvOASIS commodity line description areas will not be considered for bid evaluation or award.

| INVOICE TO | | SHIP TO | |
|---|----|---|----|
| VARIOUS AGENCY LOCATIONS AS INDICATED BY ORDER | | VARIOUS AGENCY LOCATIONS AS INDICATED BY ORDER | |
| No City | WV | No City | WV |
| US | | US | |

| Line | Comm Ln Desc | Qty | Unit Issue | Unit Price | Total Price |
|------|--|---------|------------|------------|-------------|
| 83 | Milled Rumble Strip Mobilization (ATT B Pricing Pages) | 0.00000 | LS | | |

| Comm Code | Manufacturer | Specification | Model # |
|-----------|--------------|---------------|---------|
| 24000000 | | | |

Extended Description:
Vendor shall provide bid pricing on the ATT A and ATT B Pricing Pages. Pricing or notations made in wvOASIS commodity line description areas will not be considered for bid evaluation or award.

| INVOICE TO | | SHIP TO | |
|---|----|---|----|
| VARIOUS AGENCY LOCATIONS AS INDICATED BY ORDER | | VARIOUS AGENCY LOCATIONS AS INDICATED BY ORDER | |
| No City | WV | No City | WV |
| US | | US | |

| Line | Comm Ln Desc | Qty | Unit Issue | Unit Price | Total Price |
|------|---|---------|------------|------------|-------------|
| 84 | Parking Lot and Facility Paving Surcharge | 0.00000 | TON | | |

| Comm Code | Manufacturer | Specification | Model # |
|-----------|--------------|---------------|---------|
| 30121600 | | | |

Extended Description:
Parking Lot and Facility Paving Surcharge - Items Nos. 1-17, 65, and 68
Vendor shall provide bid pricing on the ATT A and ATT B Pricing Pages. Pricing or notations made in wvOASIS commodity line description areas will not be considered for bid evaluation or award.

| INVOICE TO | | SHIP TO | |
|---|----|---|----|
| VARIOUS AGENCY LOCATIONS AS INDICATED BY ORDER | | VARIOUS AGENCY LOCATIONS AS INDICATED BY ORDER | |
| No City US | WV | No City US | WV |

| Line | Comm Ln Desc | Qty | Unit Issue | Unit Price | Total Price |
|------|-----------------------|---------|------------|------------|-------------|
| 85 | Cleaning and Sweeping | 0.00000 | SY | | |

| Comm Code | Manufacturer | Specification | Model # |
|-----------|--------------|---------------|---------|
| 72141100 | | | |

Extended Description:

Vendor shall provide bid pricing on the ATT A and ATT B Pricing Pages. Pricing or notations made in wvOASIS commodity line description areas will not be considered for bid evaluation or award.

| INVOICE TO | | SHIP TO | |
|---|----|---|----|
| VARIOUS AGENCY LOCATIONS AS INDICATED BY ORDER | | VARIOUS AGENCY LOCATIONS AS INDICATED BY ORDER | |
| No City US | WV | No City US | WV |

| Line | Comm Ln Desc | Qty | Unit Issue | Unit Price | Total Price |
|------|---|---------|------------|------------|-------------|
| 86 | Traffic Maintenance: Pilot Truck and Driver | 0.00000 | DAY | | |

| Comm Code | Manufacturer | Specification | Model # |
|-----------|--------------|---------------|---------|
| 46161500 | | | |

Extended Description:

Vendor shall provide bid pricing on the ATT A and ATT B Pricing Pages. Pricing or notations made in wvOASIS commodity line description areas will not be considered for bid evaluation or award.

| INVOICE TO | | SHIP TO | |
|--|----|--|----|
| VARIOUS AGENCY LOCATIONS AS INDICATED BY ORDER | | VARIOUS AGENCY LOCATIONS AS INDICATED BY ORDER | |
| No City | WV | No City | WV |
| US | | US | |

| Line | Comm Ln Desc | Qty | Unit Issue | Unit Price | Total Price |
|------|--|---------|------------|------------|-------------|
| 87 | Traffic Maintenance: Traffic Control Devices | 0.00000 | UNIT | | |

| Comm Code | Manufacturer | Specification | Model # |
|-----------|--------------|---------------|---------|
| 46161500 | | | |

Extended Description:

Vendor shall provide bid pricing on the ATT A and ATT B Pricing Pages. Pricing or notations made in wvOASIS commodity line description areas will not be considered for bid evaluation or award.

| INVOICE TO | | SHIP TO | |
|--|----|--|----|
| VARIOUS AGENCY LOCATIONS AS INDICATED BY ORDER | | VARIOUS AGENCY LOCATIONS AS INDICATED BY ORDER | |
| No City | WV | No City | WV |
| US | | US | |

| Line | Comm Ln Desc | Qty | Unit Issue | Unit Price | Total Price |
|------|------------------------------|---------|------------|------------|-------------|
| 88 | Traffic Maintenance: Flagger | 0.00000 | HOUR | | |

| Comm Code | Manufacturer | Specification | Model # |
|-----------|--------------|---------------|---------|
| 46161500 | | | |

Extended Description:

Vendor shall provide bid pricing on the ATT A and ATT B Pricing Pages. Pricing or notations made in wvOASIS commodity line description areas will not be considered for bid evaluation or award.

| INVOICE TO | | SHIP TO | |
|--|----|--|----|
| VARIOUS AGENCY LOCATIONS AS INDICATED BY ORDER | | VARIOUS AGENCY LOCATIONS AS INDICATED BY ORDER | |
| No City | WV | No City | WV |
| US | | US | |

| Line | Comm Ln Desc | Qty | Unit Issue | Unit Price | Total Price |
|------|----------------------------------|---------|------------|------------|-------------|
| 89 | Traffic Maintenance: Arrow Board | 0.00000 | DAY | | |

| Comm Code | Manufacturer | Specification | Model # |
|-----------|--------------|---------------|---------|
| 46161500 | | | |

Extended Description:
Vendor shall provide bid pricing on the ATT A and ATT B Pricing Pages. Pricing or notations made in wvOASIS commodity line description areas will not be considered for bid evaluation or award.

| INVOICE TO | | SHIP TO | |
|--|----|--|----|
| VARIOUS AGENCY LOCATIONS AS INDICATED BY ORDER | | VARIOUS AGENCY LOCATIONS AS INDICATED BY ORDER | |
| No City | WV | No City | WV |
| US | | US | |

| Line | Comm Ln Desc | Qty | Unit Issue | Unit Price | Total Price |
|------|--------------------------------------|---------|------------|------------|-------------|
| 90 | Off-Season Plant Opening - First Day | 0.00000 | DAY | | |

| Comm Code | Manufacturer | Specification | Model # |
|-----------|--------------|---------------|---------|
| 30121600 | | | |

Extended Description:
Vendor shall provide bid pricing on the ATT A and ATT B Pricing Pages. Pricing or notations made in wvOASIS commodity line description areas will not be considered for bid evaluation or award.

| INVOICE TO | | SHIP TO | |
|---|----|---|----|
| VARIOUS AGENCY LOCATIONS AS INDICATED BY ORDER | | VARIOUS AGENCY LOCATIONS AS INDICATED BY ORDER | |
| No City US | WV | No City US | WV |

| Line | Comm Ln Desc | Qty | Unit Issue | Unit Price | Total Price |
|------|--|---------|------------|------------|-------------|
| 91 | Off-Season Plant Opening - Each Additional Day | 0.00000 | DAY | | |

| Comm Code | Manufacturer | Specification | Model # |
|-----------|--------------|---------------|---------|
| 30121600 | | | |

Extended Description:

Vendor shall provide bid pricing on the ATT A and ATT B Pricing Pages. Pricing or notations made in wvOASIS commodity line description areas will not be considered for bid evaluation or award.

| INVOICE TO | | SHIP TO | |
|---|----|---|----|
| VARIOUS AGENCY LOCATIONS AS INDICATED BY ORDER | | VARIOUS AGENCY LOCATIONS AS INDICATED BY ORDER | |
| No City US | WV | No City US | WV |

| Line | Comm Ln Desc | Qty | Unit Issue | Unit Price | Total Price |
|------|--|---------|------------|------------|-------------|
| 92 | Raised Pavement Marker (RPM), Type R-4 with Installation | 0.00000 | EA | | |

| Comm Code | Manufacturer | Specification | Model # |
|-----------|--------------|---------------|---------|
| 72151306 | | | |

Extended Description:

Vendor shall provide bid pricing on the ATT A and ATT B Pricing Pages. Pricing or notations made in wvOASIS commodity line description areas will not be considered for bid evaluation or award.

| INVOICE TO | | SHIP TO | |
|--|----|--|----|
| VARIOUS AGENCY LOCATIONS AS INDICATED BY ORDER | | VARIOUS AGENCY LOCATIONS AS INDICATED BY ORDER | |
| No City | WV | No City | WV |
| US | | US | |

| Line | Comm Ln Desc | Qty | Unit Issue | Unit Price | Total Price |
|------|--|---------|------------|------------|-------------|
| 93 | Raised Pavement Marker (RPM), Type R-4 with Installation | 0.00000 | EA | | |

| Comm Code | Manufacturer | Specification | Model # |
|-----------|--------------|---------------|---------|
| 72151306 | | | |

Extended Description:

Vendor shall provide bid pricing on the ATT A and ATT B Pricing Pages. Pricing or notations made in wvOASIS commodity line description areas will not be considered for bid evaluation or award.

| INVOICE TO | | SHIP TO | |
|--|----|--|----|
| VARIOUS AGENCY LOCATIONS AS INDICATED BY ORDER | | VARIOUS AGENCY LOCATIONS AS INDICATED BY ORDER | |
| No City | WV | No City | WV |
| US | | US | |

| Line | Comm Ln Desc | Qty | Unit Issue | Unit Price | Total Price |
|------|---|---------|------------|------------|-------------|
| 94 | RPM Installation Mobilization (ATT B Pricing Pages) | 0.00000 | LS | | |

| Comm Code | Manufacturer | Specification | Model # |
|-----------|--------------|---------------|---------|
| 24000000 | | | |

Extended Description:

Vendor shall provide bid pricing on the ATT A and ATT B Pricing Pages. Pricing or notations made in wvOASIS commodity line description areas will not be considered for bid evaluation or award.

| INVOICE TO | | SHIP TO | |
|---|----|---|----|
| VARIOUS AGENCY LOCATIONS AS INDICATED BY ORDER | | VARIOUS AGENCY LOCATIONS AS INDICATED BY ORDER | |
| No City | WV | No City | WV |
| US | | US | |

| Line | Comm Ln Desc | Qty | Unit Issue | Unit Price | Total Price |
|------|--------------------------------------|---------|------------|------------|-------------|
| 95 | Raised Pavement Marker (RPM) Removal | 0.00000 | EA | | |

| Comm Code | Manufacturer | Specification | Model # |
|-----------|--------------|---------------|---------|
| 72151306 | | | |

Extended Description:

Vendor shall provide bid pricing on the ATT A and ATT B Pricing Pages. Pricing or notations made in wvOASIS commodity line description areas will not be considered for bid evaluation or award.

| INVOICE TO | | SHIP TO | |
|---|----|---|----|
| VARIOUS AGENCY LOCATIONS AS INDICATED BY ORDER | | VARIOUS AGENCY LOCATIONS AS INDICATED BY ORDER | |
| No City | WV | No City | WV |
| US | | US | |

| Line | Comm Ln Desc | Qty | Unit Issue | Unit Price | Total Price |
|------|--|---------|------------|------------|-------------|
| 96 | RPM Removal Mobilization (ATT B Pricing Pages) | 0.00000 | LS | | |

| Comm Code | Manufacturer | Specification | Model # |
|-----------|--------------|---------------|---------|
| 24000000 | | | |

Extended Description:

Vendor shall provide bid pricing on the ATT A and ATT B Pricing Pages. Pricing or notations made in wvOASIS commodity line description areas will not be considered for bid evaluation or award.

| INVOICE TO | | SHIP TO | |
|---|----|---|----|
| VARIOUS AGENCY LOCATIONS AS INDICATED BY ORDER | | VARIOUS AGENCY LOCATIONS AS INDICATED BY ORDER | |
| No City | WV | No City | WV |
| US | | US | |

| Line | Comm Ln Desc | Qty | Unit Issue | Unit Price | Total Price |
|------|---|---------|------------|------------|-------------|
| 97 | VRAM (Void Reducing Asphalt Membrane) 0-1,000 LF | 0.00000 | LF | | |

| Comm Code | Manufacturer | Specification | Model # |
|-----------|--------------|---------------|---------|
| 30121600 | | | |

Extended Description:

Vendor shall provide bid pricing on the ATT A and ATT B Pricing Pages. Pricing or notations made in wvOASIS commodity line description areas will not be considered for bid evaluation or award.

| INVOICE TO | | SHIP TO | |
|---|----|---|----|
| VARIOUS AGENCY LOCATIONS AS INDICATED BY ORDER | | VARIOUS AGENCY LOCATIONS AS INDICATED BY ORDER | |
| No City | WV | No City | WV |
| US | | US | |

| Line | Comm Ln Desc | Qty | Unit Issue | Unit Price | Total Price |
|------|---|---------|------------|------------|-------------|
| 98 | VRAM (Void Reducing Asphalt Membrane) 1,001-2,000 LF | 0.00000 | LF | | |

| Comm Code | Manufacturer | Specification | Model # |
|-----------|--------------|---------------|---------|
| 30121600 | | | |

Extended Description:

Vendor shall provide bid pricing on the ATT A and ATT B Pricing Pages. Pricing or notations made in wvOASIS commodity line description areas will not be considered for bid evaluation or award.

| INVOICE TO | | SHIP TO | |
|--|----|--|----|
| VARIOUS AGENCY LOCATIONS AS INDICATED BY ORDER | | VARIOUS AGENCY LOCATIONS AS INDICATED BY ORDER | |
| No City US | WV | No City US | WV |

| Line | Comm Ln Desc | Qty | Unit Issue | Unit Price | Total Price |
|------|---|---------|------------|------------|-------------|
| 99 | VRAM (Void Reducing Asphalt Membrane) 2,001-5,000 LF | 0.00000 | LF | | |

| Comm Code | Manufacturer | Specification | Model # |
|-----------|--------------|---------------|---------|
| 30121600 | | | |

Extended Description:
Vendor shall provide bid pricing on the ATT A and ATT B Pricing Pages. Pricing or notations made in wvOASIS commodity line description areas will not be considered for bid evaluation or award.

| INVOICE TO | | SHIP TO | |
|--|----|--|----|
| VARIOUS AGENCY LOCATIONS AS INDICATED BY ORDER | | VARIOUS AGENCY LOCATIONS AS INDICATED BY ORDER | |
| No City US | WV | No City US | WV |

| Line | Comm Ln Desc | Qty | Unit Issue | Unit Price | Total Price |
|------|--|---------|------------|------------|-------------|
| 100 | VRAM (Void Reducing Asphalt Membrane) 5,001 LF or greater | 0.00000 | LF | | |

| Comm Code | Manufacturer | Specification | Model # |
|-----------|--------------|---------------|---------|
| 30121600 | | | |

Extended Description:
Vendor shall provide bid pricing on the ATT A and ATT B Pricing Pages. Pricing or notations made in wvOASIS commodity line description areas will not be considered for bid evaluation or award.

| INVOICE TO | | SHIP TO | |
|---|----|---|----|
| VARIOUS AGENCY LOCATIONS AS INDICATED BY ORDER | | VARIOUS AGENCY LOCATIONS AS INDICATED BY ORDER | |
| No City US | WV | No City US | WV |

| Line | Comm Ln Desc | Qty | Unit Issue | Unit Price | Total Price |
|------|---|---------|------------|------------|-------------|
| 101 | VRAM Preparation - Removal of Center Line | 0.00000 | LF | | |

| Comm Code | Manufacturer | Specification | Model # |
|-----------|--------------|---------------|---------|
| 30121600 | | | |

Extended Description:
Vendor shall provide bid pricing on the ATT A and ATT B Pricing Pages. Pricing or notations made in wvOASIS commodity line description areas will not be considered for bid evaluation or award.

| INVOICE TO | | SHIP TO | |
|---|----|---|----|
| VARIOUS AGENCY LOCATIONS AS INDICATED BY ORDER | | VARIOUS AGENCY LOCATIONS AS INDICATED BY ORDER | |
| No City US | WV | No City US | WV |

| Line | Comm Ln Desc | Qty | Unit Issue | Unit Price | Total Price |
|------|---|---------|------------|------------|-------------|
| 102 | VRAM Mobilization (ATT B Pricing Pages) | 0.00000 | LF | | |

| Comm Code | Manufacturer | Specification | Model # |
|-----------|--------------|---------------|---------|
| 30121600 | | | |

Extended Description:
Vendor shall provide bid pricing on the ATT A and ATT B Pricing Pages. Pricing or notations made in wvOASIS commodity line description areas will not be considered for bid evaluation or award.

| SCHEDULE OF EVENTS | | |
|--------------------|------------------------------------|------------|
| Line | Event | Event Date |
| 1 | Technical Questions due by 10:30am | 2024-09-04 |

| | Document Phase | Document Description | Page 53 |
|---------------|----------------|---|------------|
| DOT2500000011 | Final | Asphalt Materials, Delivery & Labor by Vendor 6624C096 | |

ADDITIONAL TERMS AND CONDITIONS

See attached document(s) for additional Terms and Conditions

**GENERAL TERMS AND CONDITIONS:
(Agency Delegated Procurements Only)**

1. CONTRACTUAL AGREEMENT: Issuance of an Award Document signed by the Agency and approved as to form by the Attorney General's office, if required, constitutes acceptance by the State of this Contract made by and between the State of West Virginia and the Vendor. Vendor's signature on its bid, or on the Contract if the Contract is not the result of a bid solicitation, signifies Vendor's agreement to be bound by and accept the terms and conditions contained in this Contract.

2. DEFINITIONS: As used in this Solicitation/Contract, the following terms shall have the meanings attributed to them below. Additional definitions may be found in the specifications included with this Solicitation/Contract.

2.1. "Agency" or "Agencies" means the agency, board, commission, or other entity of the State of West Virginia that is identified on the first page of the Solicitation or any other public entity seeking to procure goods or services under this Contract.

2.2. "Bid" or "Proposal" means the vendors submitted response to this solicitation.

2.3. "Contract" means the binding agreement that is entered into between the State and the Vendor to provide the goods or services requested in the Solicitation.

2.4. "Director" means the Director of the West Virginia Department of Administration, Purchasing Division.

2.5. "Purchasing Division" means the West Virginia Department of Administration, Purchasing Division.

2.6. "Award Document" means the document signed by the Agency that identifies the Vendor as the contract holder.

2.7. "Solicitation" means the official notice of an opportunity to supply the State with goods or services.

2.8. "State" means the State of West Virginia and/or any of its agencies, commissions, boards, etc. as context requires.

2.9. "Vendor" or "Vendors" means any entity submitting a bid in response to the Solicitation, the entity that has been selected as the lowest responsible bidder, or the entity that has been awarded the Contract as context requires.

3. CONTRACT TERM; RENEWAL; EXTENSION: The term of this Contract shall be determined in accordance with the category that has been identified as applicable to this Contract below:

Term Contract

Initial Contract Term: This Contract becomes effective on January 1, 2025 and the initial contract term extends until 12/31/2025.

Renewal Term: This Contract may be renewed upon the mutual written consent of the Agency, and the Vendor. Any request for renewal should be delivered to the Agency thirty (30) days prior to the expiration date of the initial contract term or appropriate renewal term. A Contract renewal shall be in accordance with the terms and conditions of the original contract. Unless otherwise specified below, renewal of this Contract is limited to three (3) successive one (1) year periods or multiple renewal periods of less than one year, provided that the multiple renewal periods do not exceed the total number of months available in all renewal years combined. Automatic renewal of this Contract is prohibited.

Alternate Renewal Term – This contract may be renewed for _____ successive _____ year periods or shorter periods provided that they do not exceed the total number of months contained in all available renewals. Automatic renewal of this Contract is prohibited. Renewals must be approved by the Vendor and Agency.

Delivery Order Limitations: In the event that this contract permits delivery orders, a delivery order may only be issued during the time this Contract is in effect. Any delivery order issued within one year of the expiration of this Contract shall be effective for one year from the date the delivery order is issued. No delivery order may be extended beyond one year after this Contract has expired.

Fixed Period Contract: This Contract becomes effective upon Vendor's receipt of the notice to proceed and must be completed within _____ days.

Fixed Period Contract with Renewals: This Contract becomes effective upon Vendor's receipt of the notice to proceed and part of the Contract more fully described in the attached specifications must be completed within _____ days. Upon completion of the work covered by the preceding sentence, the vendor agrees that maintenance, monitoring, or warranty services will be provided for _____ year(s) thereafter.

One Time Purchase: The term of this Contract shall run from the issuance of the Award Document until all of the goods contracted for have been delivered, but in no event will this Contract extend for more than one fiscal year.

Construction/Project Oversight: This Contract becomes effective on the effective start date listed on the first page of this Contract, identified as the State of West Virginia contract cover page containing the signatures of the State Agency (or another page identified as _____), and continues until the project for which the vendor is providing oversight is complete.

Other: See attached.

4. AUTHORITY TO PROCEED: Vendor is authorized to begin performance of this contract on the date of encumbrance listed on the front page of the Award Document unless either the box for “Fixed Period Contract” or “Fixed Period Contract with Renewals” has been checked in Section 3 above. If either “Fixed Period Contract” or “Fixed Period Contract with Renewals” has been checked, Vendor must not begin work until it receives a separate notice to proceed from the State. The notice to proceed will then be incorporated into the Contract via change order to memorialize the official date that work commenced.

5. QUANTITIES: The quantities required under this Contract shall be determined in accordance with the category that has been identified as applicable to this Contract below.

Open End Contract: Quantities listed in this Solicitation/Award Document are approximations only, based on estimates supplied by the Agency. It is understood and agreed that the Contract shall cover the quantities actually ordered for delivery during the term of the Contract, whether more or less than the quantities shown.

Service: The scope of the service to be provided will be more clearly defined in the specifications included herewith.

Combined Service and Goods: The scope of the service and deliverable goods to be provided will be more clearly defined in the specifications included herewith.

One Time Purchase: This Contract is for the purchase of a set quantity of goods that are identified in the specifications included herewith. Once those items have been delivered, no additional goods may be procured under this Contract without an appropriate change order approved by the Vendor, Agency, Purchasing Division, and Attorney General’s office.

Construction: This Contract is for construction activity more fully defined in the specifications.

6. EMERGENCY PURCHASES: The Purchasing Division Director may authorize the Agency to purchase goods or services in the open market that Vendor would otherwise provide under this Contract if those goods or services are for immediate or expedited delivery in an emergency. Emergencies shall include, but are not limited to, delays in transportation or an unanticipated increase in the volume of work. An emergency purchase in the open market, approved by the Purchasing Division Director, shall not constitute of breach of this Contract and shall not entitle the Vendor to any form of compensation or damages. This provision does not excuse the State from fulfilling its obligations under a One Time Purchase contract.

7. REQUIRED DOCUMENTS: All of the items checked below must be provided to the Agency by the Vendor as specified below.

LICENSE(S) / CERTIFICATIONS / PERMITS: In addition to anything required under the Section of the General Terms and Conditions entitled Licensing, the apparent successful Vendor shall furnish proof of the following licenses, certifications, and/or permits upon request and in a form acceptable to the State. The request may be prior to or after contract award at the State's sole discretion.

West Virginia Contractor's License

The apparent successful Vendor shall also furnish proof of any additional licenses or certifications contained in the specifications regardless of whether or not that requirement is listed above.

8. INSURANCE: The apparent successful Vendor shall furnish proof of the insurance identified by a checkmark below on each policy prior to Contract award. The insurance coverages identified below must be maintained throughout the life of this contract. Thirty (30) days prior to the expiration of the insurance policies Vendor shall provide the Agency with proof that the insurance

mandated herein has been continued. Vendor must also provide Agency with immediate notice of any changes in its insurance policies, including but not limited to, policy cancelation, policy reduction, or change in insurers. The apparent successful Vendor shall also furnish proof of any additional insurance requirements contained in the specifications prior to Contract award regardless of whether or not that insurance requirement is listed in this section.

Vendor must maintain:

Commercial General Liability Insurance in at least an amount of:
\$1,000,000.00 _____ per occurrence.

Automobile Liability Insurance in at least an amount of: \$1,000,000.00 _____ per occurrence.

Professional/Malpractice/Errors and Omission Insurance in at least an amount of: _____ per occurrence. Notwithstanding the forgoing, Vendor's are not required to list the State as an additional insured for this type of policy.

Commercial Crime and Third Party Fidelity Insurance in an amount of: _____ per occurrence.

Cyber Liability Insurance in an amount of: _____ per occurrence.

Builders Risk Insurance in an amount equal to 100% of the amount of the Contract.

Pollution Insurance in an amount of: _____ per occurrence.

Aircraft Liability in an amount of: _____ per occurrence.

9. WORKERS' COMPENSATION INSURANCE: Vendor shall comply with laws relating to workers compensation, shall maintain workers' compensation insurance when required, and shall furnish proof of workers' compensation insurance upon request.

10. LIQUIDATED DAMAGES: This clause shall in no way be considered exclusive and shall not limit the State or Agency's right to pursue any other available remedy. Vendor shall pay liquidated damages in the amount specified below or as described in the specifications:

_____ for _____

Liquidated Damages Contained in the Specifications.

Liquidated Damages Are Not Included in this Contract.

11. ACCEPTANCE: Vendor's signature on its bid, or on the certification and signature page, constitutes an offer to the State that cannot be unilaterally withdrawn, signifies that the product or service proposed by vendor meets the mandatory requirements contained in the Solicitation for that product or service, unless otherwise indicated, and signifies acceptance of the terms and conditions contained in the Solicitation unless otherwise indicated.

12. PRICING: The pricing set forth herein is firm for the life of the Contract, unless specified elsewhere within this Solicitation/Contract by the State. A Vendor's inclusion of price adjustment provisions in its bid, without an express authorization from the State in the Solicitation to do so, may result in bid disqualification. Notwithstanding the foregoing, Vendor must extend any publicly advertised sale price to the State and invoice at the lower of the contract price or the publicly advertised sale price.

13. PAYMENT IN ARREARS: Payments for goods/services will be made in arrears only upon receipt of a proper invoice, detailing the goods/services provided or receipt of the goods/services, whichever is later. Notwithstanding the foregoing, payments for software licenses, subscriptions, or maintenance may be paid annually in advance.

14. PAYMENT METHODS: Vendor must accept payment by electronic funds transfer or P-Card. (The State of West Virginia's Purchasing Card program, administered under contract by a banking institution, processes payment for goods and services through state designated credit cards.)

15. ADDITIONAL FEES: Vendor is not permitted to charge additional fees or assess additional charges that were not either expressly provided for in the solicitation published by the State of West Virginia, included in the Contract, or included in the unit price or lump sum bid amount that Vendor is required by the solicitation to provide. Including such fees or charges as notes to the solicitation may result in rejection of vendor's bid. Requesting such fees or charges be paid after the contract has been awarded may result in cancellation of the contract.

16. TAXES: The Vendor shall pay any applicable sales, use, personal property or any other taxes arising out of this Contract and the transactions contemplated thereby. The State of West Virginia is exempt from federal and state taxes and will not pay or reimburse such taxes.

17. FUNDING: This Contract shall continue for the term stated herein, contingent upon funds being appropriated by the Legislature or otherwise being made available. In the event funds are not appropriated or otherwise made available, this Contract becomes void and of no effect beginning on July 1 of the fiscal year for which funding has not been appropriated or otherwise made available. If that occurs, the State may notify the Vendor that an alternative source of funding has been obtained and thereby avoid the automatic termination. Non-appropriation or non-funding shall not be considered an event of default.

18. CANCELLATION: The State reserves the right to cancel this Contract immediately upon written notice to the vendor if the materials or workmanship supplied do not conform to the specifications contained in the Contract. The Agency may also cancel any purchase or Contract upon 30 days written notice to the Vendor in accordance with West Virginia Code of State Rules § 148-1-5.2.b.

19. TIME: Time is of the essence with regard to all matters of time and performance in this Contract.

20. APPLICABLE LAW: This Contract is governed by and interpreted under West Virginia law without giving effect to its choice of law principles. Any information provided in specification manuals, or any other source, verbal or written, which contradicts or violates the West Virginia Constitution, West Virginia Code or West Virginia Code of State Rules is void and of no effect.

20A. VENUE: All legal actions for damages brought by Vendor against the State shall be brought in the West Virginia Claims Commission. Other causes of action must be brought in the West Virginia court authorized by statute to exercise jurisdiction over it.

21. COMPLIANCE WITH LAWS: Vendor shall comply with all applicable federal, state, and local laws, regulations and ordinances. By submitting a bid, Vendor acknowledges that it has reviewed, understands, and will comply with all applicable laws, regulations, and ordinances. Vendor shall notify all subcontractors providing commodities or services related to this Contract that as subcontractors, they too are required to comply with all applicable laws, regulations, and ordinances.

22. ARBITRATION: Any references made to arbitration contained in this Contract, Vendor's bid, or in any American Institute of Architects documents pertaining to this Contract are hereby deleted, void, and of no effect.

23. MODIFICATIONS: This writing is the parties' final expression of intent. Notwithstanding anything contained in this Contract to the contrary, no modification of this Contract shall be binding without mutual written consent of the Agency, and the Vendor.

24. WAIVER: The failure of either party to insist upon a strict performance of any of the terms or provision of this Contract, or to exercise any option, right, or remedy herein contained, shall not be construed as a waiver or a relinquishment for the future of such term, provision, option, right, or remedy, but the same shall continue in full force and effect. Any waiver must be expressly stated in writing and signed by the waiving party.

25. SUBSEQUENT FORMS: The terms and conditions contained in this Contract shall supersede any and all subsequent terms and conditions which may appear on any form documents submitted by Vendor to the Agency or Purchasing Division such as price lists, order forms, invoices, sales agreements, or maintenance agreements, and includes internet websites or other electronic documents. Acceptance or use of Vendor's forms does not constitute acceptance of the terms and conditions contained thereon.

26. ASSIGNMENT: Neither this Contract nor any monies due, or to become due hereunder, may be assigned by the Vendor without the express written consent of the Agency and any other government agency or office that may be required to approve such assignments.

27. WARRANTY: The Vendor expressly warrants that the goods and/or services covered by this Contract will: (a) conform to the specifications, drawings, samples, or other description furnished or specified by the Agency; (b) be merchantable and fit for the purpose intended; and (c) be free from defect in material and workmanship.

28. STATE EMPLOYEES: State employees are not permitted to utilize this Contract for personal use and the Vendor is prohibited from permitting or facilitating the same.

29. PRIVACY, SECURITY, AND CONFIDENTIALITY: The Vendor agrees that it will not disclose to anyone, directly or indirectly, any such personally identifiable information or other confidential information gained from the Agency, unless the individual who is the subject of the information consents to the disclosure in writing or the disclosure is made pursuant to the Agency's policies, procedures, and rules. Vendor further agrees to comply with the Confidentiality Policies and Information Security Accountability Requirements, set forth in www.state.wv.us/admin/purchase/privacy.

30. YOUR SUBMISSION IS A PUBLIC DOCUMENT: Vendor's entire response to the Solicitation and the resulting Contract are public documents. As public documents, they will be disclosed to the public following the bid/proposal opening or award of the contract, as required by the competitive bidding laws of West Virginia Code §§ 5A-3-1 et seq., 5-22-1 et seq., and 5G-1-1 et seq. and the Freedom of Information Act West Virginia Code §§ 29B-1-1 et seq.

DO NOT SUBMIT MATERIAL YOU CONSIDER TO BE CONFIDENTIAL, A TRADE SECRET, OR OTHERWISE NOT SUBJECT TO PUBLIC DISCLOSURE.

Submission of any bid, proposal, or other document to the Purchasing Division constitutes your explicit consent to the subsequent public disclosure of the bid, proposal, or document. The Purchasing Division will disclose any document labeled "confidential," "proprietary," "trade secret," "private," or labeled with any other claim against public disclosure of the documents, to include any "trade secrets" as defined by West Virginia Code § 47-22-1 et seq. All submissions are subject to public disclosure without notice.

31. LICENSING: In accordance with West Virginia Code of State Rules § 148-1-6.1.e, Vendor must be licensed and in good standing in accordance with any and all state and local laws and requirements by any state or local agency of West Virginia, including, but not limited to, the West Virginia Secretary of State's Office, the West Virginia Tax Department, West Virginia Insurance Commission, or any other state agency or political subdivision. Obligations related to political subdivisions may include, but are not limited to, business licensing, business and occupation taxes, inspection compliance, permitting, etc. Upon request, the Vendor must provide all necessary releases to obtain information to enable the Purchasing Division Director or the Agency to verify that the Vendor is licensed and in good standing with the above entities. Vendor shall notify all subcontractors providing commodities or services related to this Contract that as subcontractors, they too are required to be licensed, in good standing, and up-to-date on all state and local obligations as described in this section.

32. ANTITRUST: In submitting a bid to, signing a contract with, or accepting an Award Document from any agency of the State of West Virginia, the Vendor agrees to convey, sell, assign, or transfer to the State of West Virginia all rights, title, and interest in and to all causes of action it may now or hereafter acquire under the antitrust laws of the United States and the State of West Virginia for price fixing and/or unreasonable restraints of trade relating to the particular commodities or services purchased or acquired by the State of West Virginia. Such assignment shall be made and become effective at the time the purchasing agency tenders the initial payment to Vendor.

33. VENDOR NON-CONFLICT: Neither Vendor nor its representatives are permitted to have any interest, nor shall they acquire any interest, direct or indirect, which would compromise the performance of its services hereunder. Any such interests shall be promptly presented in detail to the Agency.

34. VENDOR RELATIONSHIP: The relationship of the Vendor to the State shall be that of an independent contractor and no principal-agent relationship or employer-employee relationship is contemplated or created by this Contract. The Vendor as an independent contractor is solely liable for the acts and omissions of its employees and agents. Vendor shall be responsible for selecting, supervising, and compensating any and all individuals employed pursuant to the terms of this Solicitation and resulting contract. Neither the Vendor, nor any employees or subcontractors of the Vendor, shall be deemed to be employees of the State for any purpose whatsoever. Vendor shall be exclusively responsible for payment of employees and contractors for all wages and salaries, taxes, withholding payments, penalties, fees, fringe benefits, professional liability insurance premiums, contributions to insurance and pension, or other deferred compensation plans, including but not limited to, Workers' Compensation and Social Security obligations, licensing fees, etc. and the filing of all necessary documents, forms, and returns pertinent to all of the foregoing. Vendor shall hold harmless the State, and shall provide the State and Agency with a defense against any and all claims including, but not limited to, the foregoing payments, withholdings, contributions, taxes, Social Security taxes, and employer income tax returns.

35. INDEMNIFICATION: The Vendor agrees to indemnify, defend, and hold harmless the State and the Agency, their officers, and employees from and against: (1) Any claims or losses for services rendered by any subcontractor, person, or firm performing or supplying services, materials, or supplies in connection with the performance of the Contract; (2) Any claims or losses resulting to any person or entity injured or damaged by the Vendor, its officers, employees, or subcontractors by the publication, translation, reproduction, delivery, performance, use, or disposition of any data used under the Contract in a manner not authorized by the Contract, or by Federal or State statutes or regulations; and (3) Any failure of the Vendor, its officers, employees, or subcontractors to observe State and Federal laws including, but not limited to, labor and wage and hour laws.

36. NO DEBT CERTIFICATION: In accordance with West Virginia Code §§ 5A-3-10a and 5-22-1(i), the State is prohibited from awarding a contract to any bidder that owes a debt to the State or a political subdivision of the State. By submitting a bid, or entering into a contract with the State, Vendor is affirming that (1) for construction contracts, the vendor is not in default on any monetary obligation owed to the state or a political subdivision of the state, and (2) for all other contracts, that neither vendor nor any related party owe a debt as defined above and that neither Vendor nor any related party are in employer default as defined in the statute cited above unless the debt or employer default is permitted under the statute.

37. CONFLICT OF INTEREST: Vendor, its officers or members or employees, shall not presently have or acquire an interest, direct or indirect, which would conflict with or compromise the performance of its obligations hereunder. Vendor shall periodically inquire of its officers, members and employees to ensure that a conflict of interest does not arise. Any conflict of interest discovered shall be promptly presented in detail to the Agency.

38. REPORTS: Vendor shall provide the Agency and/or the Purchasing Division with the following reports identified by a checked box below:

Such reports as the Agency and/or the Purchasing Division may request. Requested reports may include, but are not limited to, quantities purchased, agencies utilizing the contract, total contract expenditures by agency, etc.

Quarterly reports detailing the total quantity of purchases in units and dollars, along with a listing of purchases by agency. Quarterly reports should be delivered to the Purchasing Division via email at purchasing.division@wv.gov.

39. BACKGROUND CHECK: In accordance with W. Va. Code § 15-2D-3, the State reserves the right to prohibit a service provider's employees from accessing sensitive or critical information or to be present at the Capitol complex based upon results addressed from a criminal background check. Service providers should contact the West Virginia Division of Protective Services by phone at (304) 558-9911 for more information.

40. PREFERENCE FOR USE OF DOMESTIC STEEL PRODUCTS: Except when authorized by the Director of the Purchasing Division pursuant to W. Va. Code § 5A-3-56, no contractor may use or supply steel products for a State Contract Project other than those steel products made in the United States. A contractor who uses steel products in violation of this section may be subject to civil penalties pursuant to W. Va. Code § 5A-3-56. As used in this section:

a. "State Contract Project" means any erection or construction of, or any addition to, alteration of or other improvement to any building or structure, including, but not limited to, roads or highways, or the installation of any heating or cooling or ventilating plants or other equipment, or the supply of and materials for such projects, pursuant to a contract with the State of West Virginia for which bids were solicited on or after June 6, 2001.

b. "Steel Products" means products rolled, formed, shaped, drawn, extruded, forged, cast, fabricated or otherwise similarly processed, or processed by a combination of two or more or such operations, from steel made by the open heath, basic oxygen, electric furnace, Bessemer or other steel making process. The Purchasing Division Director may, in writing, authorize the use of foreign steel products if:

c. The cost for each contract item used does not exceed one tenth of one percent (.1%) of the total contract cost or two thousand five hundred dollars (\$2,500.00), whichever is greater. For the purposes of this section, the cost is the value of the steel product as delivered to the project; or

d. The Director of the Purchasing Division determines that specified steel materials are not produced in the United States in sufficient quantity or otherwise are not reasonably available to meet contract requirements.

41. PREFERENCE FOR USE OF DOMESTIC ALUMINUM, GLASS, AND STEEL: In Accordance with W. Va. Code § 5-19-1 et seq., and W. Va. CSR § 148-10-1 et seq., for every contract or subcontract, subject to the limitations contained herein, for the construction, reconstruction, alteration, repair, improvement or maintenance of public works or for the purchase of any item of machinery or equipment to be used at sites of public works, only domestic aluminum, glass or steel products shall be supplied unless the spending officer determines, in writing, after the receipt of offers or bids, (1) that the cost of domestic aluminum, glass or steel products is unreasonable or inconsistent with the public interest of the State of West Virginia, (2) that domestic aluminum, glass or steel products are not produced in sufficient quantities to meet the contract requirements, or (3) the available domestic aluminum, glass, or steel do not meet the contract specifications. This provision only applies to public works contracts awarded in an amount more than fifty thousand dollars (\$50,000) or public works contracts that require more than ten thousand pounds of steel products.

The cost of domestic aluminum, glass, or steel products may be unreasonable if the cost is more than twenty percent (20%) of the bid or offered price for foreign made aluminum, glass, or steel products. If the domestic aluminum, glass or steel products to be supplied or produced in a "substantial labor surplus area", as defined by the United States Department of Labor, the cost of domestic aluminum, glass, or steel products may be unreasonable if the cost is more than thirty percent (30%) of the bid or offered price for foreign made aluminum, glass, or steel products. This preference shall be applied to an item of machinery or equipment, as indicated above, when the

item is a single unit of equipment or machinery manufactured primarily of aluminum, glass or steel, is part of a public works contract and has the sole purpose or of being a permanent part of a single public works project. This provision does not apply to equipment or machinery purchased by a spending unit for use by that spending unit and not as part of a single public works project.

All bids and offers including domestic aluminum, glass or steel products that exceed bid or offer prices including foreign aluminum, glass or steel products after application of the preferences provided in this provision may be reduced to a price equal to or lower than the lowest bid or offer price for foreign aluminum, glass or steel products plus the applicable preference. If the reduced bid or offer prices are made in writing and supersede the prior bid or offer prices, all bids or offers, including the reduced bid or offer prices, will be reevaluated in accordance with this rule.

42. PROHIBITION AGAINST USED OR REFURBISHED: Unless expressly permitted in the solicitation published by the State, Vendor must provide new, unused commodities, and is prohibited from supplying used or refurbished commodities, in fulfilling its responsibilities under this Contract.

43. VOID CONTRACT CLAUSES – This Contract is subject to the provisions of West Virginia Code § 5A-3-62, which automatically voids certain contract clauses that violate State law.

DESIGNATED CONTACT: Vendor appoints the individual identified in this Section as the Contract Administrator and the initial point of contact for matters relating to this Contract.

Joseph Meadows - President

(Printed Name and Title)

367 Daytona Dr, Princeton WV 24739

(Address)

304-425-5445

(Phone Number) / (Fax Number)

sales@jandmpaving.com

(E-mail address)

CERTIFICATION AND SIGNATURE: By signing below, or submitting documentation through wvOASIS, I certify that I have reviewed this Solicitation in its entirety; that I understand the requirements, terms and conditions, and other information contained herein; that this bid, offer or proposal constitutes an offer to the State that cannot be unilaterally withdrawn; that the product or service proposed meets the mandatory requirements contained in the Solicitation for that product or service, unless otherwise stated herein; that the Vendor accepts the terms and conditions contained in the Solicitation, unless otherwise stated herein; that I am submitting this bid, offer or proposal for review and consideration; ; that this bid or offer was made without prior understanding, agreement, or connection with any entity submitting a bid or offer for the same material, supplies, equipment or services; that this bid or offer is in all respects fair and without collusion or fraud; that this Contract is accepted or entered into without any prior understanding, agreement, or connection to any other entity that could be considered a violation of law; that I am authorized by the Vendor to execute and submit this bid, offer, or proposal, or any documents related thereto on Vendor's behalf; that I am authorized to bind the vendor in a contractual relationship; and that to the best of my knowledge, the Vendor has properly registered with any State agency that may require registration.

By signing below, I further certify that I understand this Contract is subject to the provisions of West Virginia Code § 5A-3-62, which automatically voids certain contract clauses that violate State law.

J&M Heating and Air Conditioning Inc, DbA J&M Paving & Sealing

(Company)



(Signature of Authorized Representative)

Joseph Meadows - President

(Printed Name and Title of Authorized Representative)

09/17/2024

(Date)

304-425-5445

(Phone Number) (Fax Number)

Revised 8/24/2023

REQUEST FOR QUOTATION
Asphalt Material, Delivery, & Labor by Vendor

SPECIFICATIONS

1. **PURPOSE AND SCOPE:** The West Virginia Division of Highways is soliciting bids to establish a multi-award open-end asphalt material, delivery, and labor by vendor contract for preventive maintenance and repair projects throughout the state of West Virginia. Vendor will provide all materials, delivery, and labor at WVDOH project sites.

2. **DEFINITIONS:** The terms listed below shall have the following meanings assigned to them throughout and for the purpose of this Solicitation. Additional definitions can be found in Section 2 of the General Terms and Conditions.
 - 2.1 **“ADO” or “Agency Delivery Order”** - a written order entered by WVDOH personnel in the wvOASIS financial system against a master agreement, authorizing quantities of commodities and/or services to be delivered in accordance with all terms, conditions, and prices stipulated in the original contract.

 - 2.2 **“Approved Source,” “Approved Plant,” “Approved Product,” or “Approved Vendor”** - terms referring to the Approved Product Lists (APL) of certified manufacturers and/or products that meet acceptable levels of quality as determined by WVDOH Materials Control, Soils and Testing Division (MCS&T). These lists are updated periodically and it is the Vendors responsibility to refer to the MCS&T website to ensure compliance. Reference:
https://transportation.wv.gov/highways/mcst/Pages/APL_By_Number.aspx.

 - 2.3 **“Asphalt,” “Hot Mix Asphalt,” and “HMA”** - terms used interchangeably for asphalt.

 - 2.4 **“Contract Item(s)”** - the list of items available for Vendor to provide pricing as identified in Section 3 of this Solicitation and referenced throughout.

 - 2.5 **“Contractor” or “Vendor”** - interchangeably used throughout this Solicitation and in any cited Sections of the West Virginia Department of Transportation, Division of Highways Standard Specifications, Roads and Bridges, adopted latest Standard Specs edition, as amended, including any Supplementals and refers to any entity submitting a bid in response to the Solicitation, the entity that has been selected as the lowest responsible bidder, or the entity that has been awarded the Contract, as context requires.

 - 2.6 **“Emergency Work”** - work or orders required to be done without delay and owing to circumstances for which the WVDOH could not have reasonably expected and has been designated as such by a representative of the WVDOH.

REQUEST FOR QUOTATION
Asphalt Material, Delivery, & Labor by Vendor

- 2.7 “ESAL” – means Equivalent Single Axle Load and establishes a damage relationship for comparing the effects of axles carrying different loads.
- 2.8 “FOB” or “Free on Board” – indicates that the price for goods includes delivery at the Vendor’s expense to a specified point, and that the Vendor retains liability for loss or damage until the goods are delivered.
- 2.9 “HPTO” - High Performance Thin Overlay.
- 2.10 “Liquidated Damages” - monetary compensation due from the Vendor in the event the Vendor’s performance falls short of contractual stipulation or breaches the contract. Delays in the delivery of goods and/or services or quality failures or corrections by the Vendor may result in the Agency assessing charges for such deficiencies per these contract Specifications, the Standard Specs Section 108.7, as amended, and calculated from the table posted in Section 8.4.1 of these Specifications.
- 2.11 “MCS&T” - The WVDOH Materials Control, Soils and Testing Division, who perform all procedures necessary with sampling, testing, reporting and inspection of products and materials to maintain a reliable quality assurance system. Reference: <https://transportation.wv.gov/highways/mcst/Pages/default.aspx>.
- 2.12 “MP” - refers to a Materials Procedure per the Materials Control, Soils, and Testing Division of the West Virginia Division of Highways, as amended. Reference: <https://transportation.wv.gov/highways/mcst/Pages/WVDOH-Materials-Procedures.aspx>
- 2.13 “PG” – Performance Graded.
- 2.14 “Plant Information Form” and “Information Form” - mandatory forms which the Vendor must complete and submit with their bid to identify each of the Vendor’s sourced Plants. Vendor shall provide Plant name, location, and counties served for each Plant sourced for asphalt and/or stone Materials associated with this contract’s Pricing Pages. Plant Information forms are mandatory and must accompany their respective Pricing Pages and be submitted at the time of bid. **This Solicitation requires a minimum of TWO (2) Plant Information Forms: Attachment C Asphalt Plant Information Form (ATT C) and Attachment D Stone Plant Information Form (ATT D).**
- 2.15 “Pricing Pages” - the schedule of prices attached hereto as Attachment A Pricing Pages (ATT A) and Attachment B Mobilization Pricing Pages (ATT B) which are used to evaluate the Solicitation responses. **This Solicitation requires a minimum of TWO (2) Pricing Pages: Attachment A Pricing Page (ATT A) and Attachment B Mobilization Pricing Page (ATT B).** Pricing

REQUEST FOR QUOTATION
Asphalt Material, Delivery, & Labor by Vendor

Pages shall accompany and correspond with Vendor Plant Information Forms.

- 2.16 “RAP” - Reclaimed Asphalt Pavement.
- 2.17 “RPM” - Raised Pavement Markers.
- 2.18 “Solicitation” – - the official notice of an opportunity to supply the State with goods or services.
- 2.19 “SP” - WVDOH Special Provision.
- 2.20 “Standard Specs” – the West Virginia Department of Transportation, Division of Highways Standard Specifications, Roads and Bridges, most recent edition, as modified or amended by all subsequent Supplemental Specifications.
- 2.21 VRAM – Void Reducing Asphalt Membrane.
- 2.22 “WVDOH” or “Agency”– interchangeable terms referring to the West Virginia Division of Highways.

3. GENERAL REQUIREMENTS:

- 3.1 **Standard Specifications Roads and Bridges:** The following Standard Specs Sections shall apply, as applicable, to the administration of this contract: 101, 102, 103, 104, 105, 106, 107, 108, 109, and 110, as amended.

Materials, equipment, and performance of this contract shall conform, but is not limited to, the requirements of Sections 307, 401, 402, 408, 415, 636, and 703, as amended.

Note: All coarse aggregate used for any items listed in this contract shall meet the requirements of Section 703 of the Standard Specifications. Note 1 of Section 401.2 of the Standard Specifications shall not apply.

Free electronic copies of the Standard Specs and Supplementals are available at:
<https://transportation.wv.gov/highways/TechnicalSupport/specifications/Pages/default.aspx>.

- 3.2 **Contract Items and Mandatory Requirements:** Vendor shall provide Agency with the Contract Items listed below on an open-end and continuing basis. Contract Items must meet or exceed the mandatory requirements as shown below.

REQUEST FOR QUOTATION
Asphalt Material, Delivery, & Labor by Vendor

NOTE: Vendor must bid material and laydown services together to be considered for contract award. Bid responses received for materials only or for laydown services only will be disqualified. The WVDOH will not coordinate the ordering and payment of material and laydown services with separate vendors.

3.2.1 Asphalt Materials:

3.2.1.1 Asphalt Materials - Contract Items 1 through 17: Materials from this contract SHALL ONLY be purchased when delivery by Vendor and Labor by Vendor are required on an ADO. All materials used on this contract shall be from MCS&T approved sources/plants, as amended. Reference:
https://transportation.wv.gov/highways/mcst/Pages/APL_By_Number.aspx

3.2.2 Shoulder Stone:

3.2.2.1 Shoulder Stone Placement – Contract Item 18: Section 307 Class 10 shoulder stone material shall be bid per ton and meet the requirements of *Exhibit 1–Page 1, Shoulder Reconstruction Detail (“EXH 1–Page 1”)*, and *Exhibit 1-Page 2, Restoring Shoulder for Guardrail (“EXH 1-Page 2”)*, or as designated on the ADO and by the WVDOH District Engineer or their designee. All labor, equipment, and material shall be included in the unit bid price. Any traffic control required shall be charged separately per Section 3.2.26 of these specifications and identified accordingly as **Traffic Maintenance Contract Items 86 through 89**.

3.2.2.2 Haul by Vendor Shoulder Stone Placement – Contract Items 20 and 21: The distance over suitable routes selected by the WVDOH District Engineer or their designee using the allowed haul costs that will provide the lowest total cost to the WVDOH and shall be measured from the Vendor’s Stone plant location, which shall be identified by the Vendor on **Attachment D - Stone Plant Information Form (“ATT D”)** to the WVDOH’s mid-point of the project.

Both in-state and out-of-state delivery route mileage will be calculated by the WVDOH, using the shortest route, by utilizing “Google Earth” or a similar source for routing from the Vendor’s plant location to the WVDOH mid-point of the project location. WVDOH will determine the route to be taken due to bridge and/or road restrictions which shall have acceptable load limits for both roads and bridges.

REQUEST FOR QUOTATION
Asphalt Material, Delivery, & Labor by Vendor

3.2.2.3 Shoulder Stone Mobilization - Contract Item 19: Vendor compensation for the mobilization of shoulder stone for placement and shall be priced on **Attachment B Mobilization Pricing Pages (“ATT B”)** which shall correspond with Vendor’s **ATT D**, which includes counties sourced for Stone.

3.2.3 Performance Graded Binders - Contract Items 22 through 24: Surcharges to compensate Vendor for supplying asphalt when the referenced binder is substituted for the standard binder.

3.2.4 ESAL Surcharge - Contract Items 25 and 26: Surcharges to compensate Vendor for supplying other necessary aggregates or mix types when the asphalt design mix requires an ESAL rating of 3 million or greater. Mixes requiring less than 3 million ESAL’s do not qualify for this surcharge.

3.2.5 Asphalt Haul by Vendor – Contract Items 27 and 28: The distance over suitable routes selected by the WVDOH District Engineer or their designee using the allowed for haul costs that will provide the lowest total cost to the WVDOH and shall be measured from the Vendor’s plant location, which shall be identified on the **Attachment C Asphalt Plant Information Form (“ATT C”)** to the WVDOH’s mid-point of the project.

Both in-state and out-of-state delivery route mileage will be calculated by the WVDOH, using the shortest route, by utilizing “Google Earth” or a similar source for routing from the Vendor’s plant location to the WVDOH mid-point of the project location. WVDOH will determine the route to be taken due to bridge and/or road restrictions which shall have acceptable load limits for both roads and bridges. **Haul by Vendor will only be requested in combination with other awarded items.**

3.2.6 Laydown of Materials - Contract Items 29 through 32: Vendor shall provide laydown services for **Asphalt Section Contract Items 1 through 17** as designated on the ADO and the WVDOH District Engineer or their designee.

3.2.6.1 Safety Edge™: As per the Standard Spec Sections 410.10.2 and 401.10.6, and *Exhibit 2, Safety Edge Design Directive 650 (“EXH 2”)*, when the total specified lift thickness of pavement is 1.5 inches or greater, the Vendor shall construct an outside pavement edge with Safety Edge™, where appropriate as described in **EXH 2**, unless directed otherwise by the WVDOH District Engineer or

REQUEST FOR QUOTATION
Asphalt Material, Delivery, & Labor by Vendor

their designee. Safety Edge™ shall be installed at no additional cost to the WVDOH. **Only models listed on MCS&T's Approved Asphalt Safety Edge™ Devices listing will be accepted.** Reference:

https://transportation.wv.gov/highways/mcst/Pages/APL_By_Number.aspx, as amended.

- 3.2.7 Excavation for Shoulder Paving - Contract Items 35 through 38:** The removal of existing shoulder material for a length and width to be determined by the WVDOH District Engineer or their designee in two inch (2") vertical increments. Vendor shall include the loading, hauling, and disposal of excavated material in its bid price.

The replacement of asphalt base, asphalt wearing, or shoulder stone aggregate will be paid as shown in Sections 3.2.8 and 3.2.9 of these specifications.

- 3.2.8 Asphalt Base I Shoulder Paving Surcharge - Contract Items 39 through 42:** Surcharges for work performed to pave road shoulders consisting of installing and compacting Asphalt Base I to the elevation of the existing pavement in the shoulder that is to be paved. Vendor shall comply with *Exhibit 1-Page 3, Repaving Pipe Trenches in Paved Shoulder ("EXH 1-Page 3")*, where relevant work is performed.

NOTE the following Asphalt Base I related line Contract Items:

- Asphalt base I will be paid as **Asphalt Base 401-Base I Contract Item 1.**
 - Hauling of asphalt base I will be paid as **Asphalt Haul by Vendor Contract Items 27 and 28.**
 - Laydown of base I will be paid as **Laydown of Material Contract Items 29 through 32.**
 - Excavation for base I will be paid as **Excavation for Shoulder Paving Contract Items 35 through 38.**
 - Shoulder stone placement/restoring, and stone will be paid as **Shoulder Stone Placement for Asphalt Section 307 - Class 10 Contract Item 18.**
- 3.2.9 Asphalt Base II Shoulder Paving Surcharge - Contract Items 43 through 46:** Surcharges for work performed to pave road shoulders consisting of installing and compacting asphalt base II to the elevation of the existing pavement in the shoulder that is to be paved. Vendor shall comply with *EXH 1-Page 3*, where relevant work is performed.

REQUEST FOR QUOTATION
Asphalt Material, Delivery, & Labor by Vendor

NOTE the following Asphalt Base II related line Contract Items:

- Asphalt base II will be paid as **Asphalt Section 401 - Base II Contract Item 3**.
- Hauling of asphalt base II will be paid as **Asphalt Haul by Vendor Contract Items 27 and 28**.
- Laydown will be paid as **Laydown of Material Contract Items 29 through 32**.
- Excavation will be paid as **Excavation of Shoulder Paving Contract Items 35 through 38**.
- Shoulder stone placement/restoring, and stone will be paid as **Shoulder Stone Placement for Asphalt Section 307 – Class 10 Contract Item 18**.

3.2.10 Asphalt Material for Tack Coat - Contract Item 47: Shall be furnished and applied in accordance with Standard Specs Section 408, as amended, and as directed by the WVDOH District Engineer or their designee.

3.2.11 Additional Heel-In Joints - Contract Item 48: The beginning and the end of each paving location will be performed by Vendor, in accordance with *Exhibit 1–Page 4, Resurfacing Heel-In Detail (“EXH 1-Page 4”)*. Additional heel-in joints, in accordance with the Resurfacing Heel-In Detail, may be required as directed by the WVDOH District Engineer or their designee at intersecting roadways, at the beginning and end of each paving skip, and at other designated locations. Payment of additional heel-in joints shall be paid per linear foot as measured along the joint, which shall be full payment for complete construction of the joint.

3.2.12 Skip Paving Surcharge - Contract Item 49: Skip paving may be requested by the WVDOH District Engineer or their designee and will apply when the distance between the end of one skip and the beginning of the next exceeds 2,500 feet. Skip paving for distances less than 2500 feet from the end of one skip and the beginning of the next **will not** qualify for a skip paving surcharge. Payment shall be made for each ton of final surface course material completed in place on the project. Patching and leveling in preparation for resurfacing of a project shall not be considered skip paving.

3.2.13 Pavement Profiling/Milling: Pavement profiling/milling shall consist of profiling the existing pavement to the specified grade and cross slope by grinding, planing, or milling. The profiling equipment shall be capable of accurately establishing profile grades of one-quarter inch ($\frac{1}{4}$ ”) plus or minus, along each edge of the machine by reference from the existing pavement by use of ski or matching shoe or by reference to independent grade control. The equipment shall have an automatic system for

REQUEST FOR QUOTATION
Asphalt Material, Delivery, & Labor by Vendor

controlling grade and cross slope. The Vendor shall provide adequate manpower and auxiliary equipment to control dust and remove cuttings from the project site. Stockpiling of cuttings on the project site will not be permitted and Vendor shall be responsible for any damages to drainage facilities, manholes, or other appurtenances within the pavement area.

3.2.13.1 Pavement Profiling/Milling - Contract Items 50 through 61: Pavement profiling/milling shall be measured as the total number of square yards planed or ground to a depth not exceeding two inches (2"). Should the required removal depth exceed two inches (2"), additional quantities shall be measured for each additional two-inch (2") increment.

It shall be the WVDOH District Engineer or their designee's decision as to whether the WVDOH or the Vendor will retain ownership of the profiled/milled cuttings and will designate **Pavement Profiling/Milling-WVDOH Contract Items 50 through 55** or **Pavement Profiling/Milling-Vendor Contract Items 56 through 61** on the ADO. Vendor shall factor in the haul cost of profiled/milled cuttings up to 10 miles, one way, in its pricing of **Pavement Profiling/Milling Contract Items 50 through 61**, regardless of who will retain ownership of the millings.

3.2.13.2 Mobilization for Profiling/Milling - Contract Item 62: Vendor shall use **ATT B** to provide mobilization for profiling/milling pricing. Vendor bid pricing shall include all preparatory operations and the movement of necessary personnel and equipment to the project site to begin profiling, milling, or fine milling work. Only one mobilization fee for profiling/milling per ADO shall be paid for **Pavement Profiling/Milling Contract Items 50 through 61** or **Fine Milling Contract Items 70 through 81**.

3.2.14 Haul of Profiled/Milled Cuttings or Fine Millings - Contract Items 63 and 64: Profiled/milled cuttings or fine millings from the project site may be hauled by either WVDOH forces or the Vendor, as determined by the WVDOH District Engineer or their designee. When WVDOH retains ownership of the millings, **Pavement Profiling/Milling-WVDOH Contract Items 50 through 55** and **Fine Milling -WVDOH Contract Items 70 through 75**, hauling of profiled/milled cuttings or fine millings by the Vendor shall be to locations designated by the WVDOH District Engineer, or their designee. When Vendor retains ownership of the millings, **Pavement Profiling/Milling-Vendor Contract Items 56**

REQUEST FOR QUOTATION
Asphalt Material, Delivery, & Labor by Vendor

through 61 and Fine Milling-Vendor Contract Items 76 through 81, hauling of profiled/milled cuttings or fine millings by Vendor shall be calculated to the Vendor's nearest plant location. Mileage shall be calculated using the method described in Section 3.2.5.

The first 10-mile, one way haul of profiled/milled cuttings or fine millings shall be included with the bid price of **Pavement Profiling/Milling Contract Items 50 through 61,** and **Fine Milling Contract Items 76 through 81,** and shall not be charged separately.

Haul of profiled/milled cuttings or fine millings beyond the initial 10 miles shall be bid per ton-mile as **Haul of Profiled/Milled Cuttings or Fine Millings Contract Item 64** and shall only be charged for mileage one way. Haul of profiled/milled cuttings or fine millings shall be for full capacity, legal truckloads only, except for the last haul of the day, which permits the hauling of a partial load at the same rate.

- 3.2.15 Pavement Repair - Asphalt Base II, Contract Item 65:** Performed in conjunction with an overlay, pavement repair shall consist of squaring up the repair area, removing damaged material to a depth directed by the WVDOH District Engineer or their designee, hauling and disposing of existing pavement, tacking of existing surfaces, and placing and compacting Asphalt Base II in lifts not exceeding two inches (2") to the level of the existing pavement. The cost of asphalt base II material shall be charged separately as **Asphalt Section 401 - Base II Contract Item 3. Pavement Repair-Asphalt Base II Contract Item 65** does not qualify for asphalt price adjustments; however, asphalt base II material used for pavement repair qualifies for price adjustment, per Section 4 of these specifications.

All labor and equipment used to complete **Haul of Profiled/Milled Cuttings or Fine Millings Contract Item 64** shall be included in the unit bid price for **Contract Item 64**. Any traffic control required shall be charged separately, per Section 3.2.26 of these specifications and identified accordingly as **Traffic Maintenance Contract Items 86 through 89**.

- 3.2.15.1** Base Failure Repair shall be in accordance with *Exhibit 1 - Page 5, Base Failure Repair Detail ("EXH 1-Page 5")*.
- 3.2.15.2** Edge Failure Repair shall be in accordance with *Exhibit 1 - Page 6, Edge Failure Repair Detail ("EXH 1-Page 6")*.
- 3.2.15.3** Pothole Repair shall be in accordance with *Exhibit 1-Page 7, Pothole Repair Detail ("EXH 1-Page 7")*.

REQUEST FOR QUOTATION
Asphalt Material, Delivery, & Labor by Vendor

- 3.2.16 Asphalt Base, Wearing, and Patching and Leveling Courses:** *Exhibit 3, Special Provision 401 (“EXH 3”)*, as amended, shall address the use of increased amounts of RAP used within mixes produced for projects in the WVDOH construction program.
- 3.2.17 Crushed Aggregate Base Course:** RAP may be substituted for Class 10 shoulder stone materials on roadways where edge line pavement markings exist or are installed per Standard Specs Section 307, as amended.
- 3.2.18 Asphalt HPTO - SP496 - PG 64E-22, Contract Item 66:** Shall be in accordance with *Exhibit 4, Special Provision 496 (“EXH 4”)*, as amended.
- 3.2.18.1 Non-Tracking Tack, Contract Item 67:** To be used with **Asphalt HPTO Contract Item 66** and shall be an MCS&T approved product from an MCS&T approved Vendor and shall meet the recommended requirements of the supplier unless otherwise specified by the WVDOH District Engineer or their designee. The District Engineer or their designee may specify non-tracking tack for purposes beyond Asphalt HPTO applications. Reference:
<https://transportation.wv.gov/highways/mcst/Pages/WVDOH-Materials-Procedures.aspx>, as amended.
- 3.2.18.2 Laydown of Materials, Contract Item 68,** shall provide laydown services for **Asphalt HPTO Contract Item 66**. Any costs associated with a Material Transfer Device shall be included in the Vendor’s bid price for laydown and provided at projects designated by the WVDOH District Engineer or their designee.
- 3.2.18.3 Asphalt HPTO, Contract Item 66:** Shall be PG 64E-22 and ordered in 400-ton increments or greater. Hauling will not be included in the combined material and laydown price and shall be paid as **Asphalt Haul by Vendor Contract Items 27 and 28**.
- 3.2.19 Ultra-Thin Asphalt Overlay, Contract Item 69:** Shall be in accordance with *Exhibit 5, Special Provision 498 (“EXH 5”)*, as amended. Laydown service shall be provided per Section 3.2.6 of these contract specifications.
- 3.2.20 Fine Milling of Asphalt Pavement Surfaces, Contract Item 70 through 81:** Shall be the fine milling of existing and/or new asphalt pavement at locations shown on the plans or as directed by the WVDOH District

REQUEST FOR QUOTATION
Asphalt Material, Delivery, & Labor by Vendor

Engineer or their designee in accordance with the Standard Test Method for Measuring Pavement Macrottexture Depth using a Volumetric Technique, MP 401.07.24.

It shall be the WVDOH District Engineer or their designee's decision as to whether the WVDOH or the Vendor will retain ownership of the fine milled cuttings and will designate on the ADO **Fine Milling -WVDOH Contract Items 70 through 75** or **Fine Milling -WVDOH Contract Items 76 through 81** on the ADO. Vendor shall factor in the haul cost of profiled/milled cuttings up to 10 miles, one way, in its pricing of **Fine Milling Contract Items 70 through 81**, regardless of who will retain ownership of the millings.

3.2.21 Rumble Strips:

3.2.21.1 Milled Rumble Strips, Contract Item 82: Shall be in accordance with *Exhibit 1-Page 8, Rumble Strip Special Detail* ("EXH 1-Page 8").

3.2.21.2 Mobilization for Milled Rumble Strips - ATT B Contract Item 83: Vendor bid pricing shall include all preparatory operations and the movement of necessary personnel and equipment to the project site to begin milled rumble strip work. Only one mobilization fee per ADO shall be paid when **Contract Item 82** is required.

3.2.22 Parking Lot and Facility Paving Surcharge, Contract Item 84: A surcharge which shall be provided when materials, **Asphalt Section Contract Items 1 through 17, Asphalt HTPO Contract Item 66, and Ultra-Thin Asphalt Overlay Contract Item 69** are used to pave parking lots.

3.2.23 Cleaning and Sweeping, Contract Item 85: Shall be calculated as the paving length times the width swept. The WVDOH shall have the option to perform cleaning and sweeping.

3.2.24 Raised Pavement Markings, Contract Items 92 and 93: Must be stored and installed in accordance with Standard Specs Sections 420, 663, 715, and shall be in accordance with *Exhibit 1-Page 10, Raised Pavement Marker Types "P" and "R" Detail* ("EXH 1-Page 10"). Vendor shall bid one price per installed marker on ATT A.

REQUEST FOR QUOTATION
Asphalt Material, Delivery, & Labor by Vendor

3.2.24.1 Type P-2 RPMs must be produced by a certified manufacturer, per the most recent Division Approved Product List Material Code – 715.040.002 – Type P-2 Raised Pavement Markers. Reference:
https://transportation.wv.gov/highways/mcst/Pages/APL_By_Number.aspx

3.2.24.2 Type R-4 RPMs must meet all ASTM D4280 standards addressed in Standard Specs Section 715.40.6.2.

3.2.25 Raised Pavement Marker (RPM) Removal, Contract Item 95: Shall be removed per Standard Specs Sections 405, 420, and 663, except when the project plans indicate an alternative. Vendor shall bid one price per RPM removed.

3.2.26 Void Reducing Asphalt Membrane, Contract Items 97 through 100: Shall be in accordance with *Exhibit 6, Special Provision 403 (“EXH 6”)*, as amended. All surface preparation shall be included in the VRAM bid price except when the center line must be removed, then **VRAM Preparation - Removal of Center Line, Contract Item 101**, may be charged. No additional mobilizations shall apply.

3.2.27 Traffic Maintenance, Contract Items 86 through 89: While undergoing improvement, the project site shall be kept open to traffic in such condition that both local and through traffic will be adequately and safely accommodated. All improvement operations shall be scheduled by the Vendor to keep traffic delay to a minimum.

Traffic Control may be furnished by the WVDOH at the option of the District Engineer, or their designee; however, when **Contract Items 86 through 89** are requested by the WVDOH District Engineer or their designee for a project, traffic shall be maintained by the Vendor in accordance with Standard Specs Section 636, as amended.

3.2.28 Mobilization for Paving Limits: Vendor shall use **ATT B** to provide pricing for all Mobilization Contract Items.

Mobilization Pricing Pages - ATT B Contract Items:

- **Contract Item 19** is for Shoulder Stone Mobilization.
- **Contract Item 33** is for DAYTIME Paving Mobilization.
- **Contract Item 34** is for NIGHTTIME Paving Mobilization.
- **Contract Item 62** is for Pavement Profiling/Milling Mobilization.
- **Contract Item 83** is for Milled Rumble Strips Mobilization.

REQUEST FOR QUOTATION
Asphalt Material, Delivery, & Labor by Vendor

- **Contract Item 94** is for RPM Installation Mobilization.
- **Contract Item 95** is for RPM Removal Mobilization.
- **Contract Item 102** is for VRAM Mobilization.

Only one mobilization for paving per day of operation will be paid, unless moves of over five (5) miles between individual paving locations are required. In cases where a Vendor is required to move from one roadway to the adjacent roadway of a divided highway, additional mobilization for paving will only be paid if the nearest interchange or crossing point that will accommodate the Vendor's equipment is over five (5) miles from the paving locations.

3.2.28.1 Daytime Paving Mobilization, Contract Item 33: A mobilization for paving charge which may be paid when the ADO quantity, per paving location, is less than 500 tons of Asphalt and nighttime paving is not requested.

3.2.28.2 Nighttime Paving Mobilization, Contract Item 34: A mobilization for paving charge which may be paid when the ADO dictates paving to be done at night.

NOTE: This provision may require roundtrip moves of up to ten (10) miles with no additional mobilization for paving payment. An individual paving location shall be defined as a paving job where no skips exceeding 2,500 feet are involved, except between the approach slabs of a bridge or parallel pair of bridges.

3.2.29 Off-Season Plant Opening, Contract Items 90 and 91: If a Vendor is required to open their plant in the off-season to service the needs of the WVDOH, an additional payment will be made. The Vendor will be paid an additional day charge for each additional consecutive day that the plant is open after the first day to service the needs of the WVDOH. If the plant produces no material for any use on any calendar day, either during the week or on the weekend, the WVDOH will pay the first day rate for off-season plant opening on the next day of the WVDOH usage. Payment for this item is subject to the following conditions:

3.2.29.1 Payment for this item can only be authorized and made during the winter months, i.e., between December 15th and March 15th, and then only if the plant would not have otherwise been open. These dates may be revised by the WVDOH District Engineer or their designee, if necessary, to meet specific needs in the field. Any such revision of dates will be in writing and shall be

REQUEST FOR QUOTATION
Asphalt Material, Delivery, & Labor by Vendor

attached to the Vendor's invoice at the time payment is requested.

3.2.29.2 Payment will always be made at the full contract awarded bid price for the first day of plant opening; however, the amount paid from each additional day of plant opening will be reduced as follows:

- A. Payment for additional day charge will not be made if the plant has produced over 500 tons on that day. If between 300 and 500 tons have been produced, payment for additional day charge will be made equal to one-half of the contract awarded bid price for the additional day charge. The quantity produced to make this determination shall include all material produced that day, which includes tonnage bought by the WVDOH, other local governments and all private work.
- B. The WVDOH will only pay its share of the amount determined to be due for additional day charge as described above. For example, if the plant produces 375 tons and the WVDOH takes 150 tons of the total, 40% of the plant's daily production, payment for additional day charge would be calculated as follows: Since the total daily production is between 300 and 500 tons, the Vendor is due 50% of the additional day charge. Because the WVDOH's share of this daily production is 40%, the WVDOH would pay 40% of one-half of the additional day charge, or in this case, 20% of the additional day charges.

3.2.29.3 A certified statement shall accompany the invoice stating the total quantity produced on the additional day. If payment does not qualify due to tonnage produced, the next consecutive day of plant operation, if any, will qualify for payment at the additional day rate rather than the first day rate for plant opening.

3.2.30 Emergency Work: Emergency work as ordered by WVDOH District Engineer, or their designee is work that shall be initiated within forty-eight (48) hours from when the ADO is received by the vendor. The determination of emergency work will be in accordance with Section 2.6 of these contract specifications. Emergency shall be prominently noted on the ADO and will be paid at 1.50 times the Vendor's bid price.

REQUEST FOR QUOTATION
Asphalt Material, Delivery, & Labor by Vendor

4. PRICE ADJUSTMENTS:

4.1 Price Adjustment of Asphalt Cement: Due to the uncertainty in estimating the cost of petroleum products that will be used during the life of this contract, adjustment in compensation for **Asphalt Section Contract Items 1 through 17, Asphalt HPTO Contract Item 66, and Ultra-Thin Asphalt Overlay Contract Item 69** is provided for in the Standard Specs, as amended. Refer to the following table:

| Contract Item | Description of Asphalt Section | AC (Average Asphalt Content) |
|----------------------|---------------------------------------|-------------------------------------|
| 1 | Section 401 – Base I | 3.9 |
| 2 | Section 401 – 25mm Superpave | 4.4 |
| 3 | Section 401 – Base II | 5.0 |
| 4 | Section 401 – Patch and Level | 5.0 |
| 5 | Section 401 – Wearing IV | 5.2 |
| 6 | Section 402 – Wearing IV | 5.1 |
| 7 | Section 401 – 19mm Superpave | 4.7 |
| 8 | Section 401 – Scratch Course | 6.2 |
| 9 | Section 402 – 9.5mm Superpave | 6.1 |
| 10 | Section 401 – Wearing I | 6.1 |
| 11 | Section 402 – Wearing I | 6.0 |
| 12 | Section 401 – 4.75mm Superpave | 7.6 |
| 13 | Section 402 – 4.75mm Superpave | 7.2 |
| 14 | Section 401 – Wearing III | 7.3 |
| 15 | Section 402 – Wearing III | 7.5 |
| 16 | Section 401 - 12.5mm Superpave | 5.6 |
| 17 | Section 402 - 12.5mm Superpave | 5.6 |
| 66 | Asphalt HPTO, SP496 | 7.1 |
| 69 | Ultra-Thin Asphalt Overlay, SP498 | 7.6 |

4.2 Price Adjustment of Fuel Oil No. 2 (Diesel Fuel): Due to the uncertainty in estimating the cost of diesel fuel that will be used during the life of this contract, adjustment in compensation for applicable items shall be per Standard Specs 109.9, as amended, with the exception that factor “C” in the Price Adjustment for Fuel formula is to be broken down by component, as shown in Figure 4.2.A.

**REQUEST FOR QUOTATION
Asphalt Material, Delivery, & Labor by Vendor**

The Price Adjustment for Fuel formula to be utilized for this contract it:

$$Pa = [(Mbp \div Cbp) - 1.00] \times Cbp \times C \times Q$$

Where: Pa = Price adjustment

Mbp = Monthly base price at time of placement

Cbp = Contract base price at time of bidding

C = Cost adjustment factors per unit, as per Figure 4.2.A

Q = 'As Constructed' Quantity

FIGURE 4.2.A

| Description | Factor | Unit | Applicable Item |
|--|--------|-----------|----------------------------------|
| Asphalt Material | 0.43 | Tons | Contract Items 1 -17, 66, and 69 |
| Asphalt Hauling | 0.020 | Ton Miles | Contract Items 27 and 28 |
| Asphalt Laydown | 0.14 | Tons | Contract Items 29 - 32 |
| Aggregate Production (0.49) + Placement (0.03) | 0.52 | Tons | Contract Item 18 |
| Aggregate Haul | 0.020 | Ton Miles | Contract Items 20 and 21 |
| Excavating | 0.25 | Tons | Contract Items 35 - 38 |

The bidding index for asphalt and fuel will be listed on the Contract Administration website for Fuel, Asphalt and Cement Prices Adjustments listed for August 2024. Contract Base Price at time of bid will be based on August 2024. Reference:

<https://transportation.wv.gov/highways/contractadmin/Lettings/Pages/FuelandAsphaltPrices.aspx#FuelPrices>

NOTE: If the adjusted price of any Contract Item is less than \$0.00, WVDOH will limit the adjustment to \$0.00.

5. **ACCEPTANCE PLAN:** Quality control at the plant and in-the-field shall be the responsibility of the Vendor and shall meet the requirements of MP 401.03.50. Compaction quality control shall be in accordance with Section 401 of the Standard Specifications. Acceptance testing shall be the responsibility of the WVDOH. Quality assurance of the material shall be as set forth in MP 401.02.27 for Marshall Mix designs or MP 401.02.29 for Superpave mix designs. Referenced MP's, as amended, may be referenced at <https://transportation.wv.gov/highways/mcst/Pages/MP-400s.aspx>.

REQUEST FOR QUOTATION
Asphalt Material, Delivery, & Labor by Vendor

6. CONTRACT AWARD:

6.1 Contract Award: This Contract is intended to provide Agencies with a purchase price on all Contract Items. All qualified responsible Vendors shall be awarded a contract for those Contract Items bid which meet all mandatory requirements of this Contract. **Bidding Vendor must provide both material and laydown services within the same bid; bids received for material only or laydown services only will be disqualified.** The WVDOH will not coordinate materials and laydown services with separate Vendors.

6.1.1 Determining Low Bid Per Project: To determine the low bid Vendor for individual repair paving projects, the WVDOH District Engineer or their designee will calculate the lowest overall total cost of the Contract Items required for individual projects. A written ADO will be issued to the Vendor with the lowest overall total cost. Charges for hauling will be calculated according to Section 3.2.5 of these contract specifications.

WVDOH reserves the right to request any one or combination of items for which bids are awarded at the lowest overall total as set forth in this section.

6.2 Pricing Pages, Attachment A (“ATT A”) and Attachment B (ATT B): Vendor shall clearly identify the applicable counties on ATT A by marking an “X” beside applicable county/counties for which the bid prices apply. Vendor shall clearly identify their bid, by county, on ATT B by providing a lump sum price beside the applicable county/counties for each mobilization Contract Item they are bidding on, as listed in Section 3.2 of these Contract Specifications. The Pricing Pages spreadsheets list Contract Items with no guarantee that any Contract Item will be purchased throughout the life of this contract. Estimated quantities are not available.

NOTE: Bids that do not include ATT A, ATT B, ATT C, and ATT D WILL BE DISQUALIFIED.

6.2.1 Bid evaluations will be based on the bid prices submitted on ATT A and ATT B. Vendor entries of bid prices or other notations made in wvOASIS commodity line descriptions will not be considered for bid evaluation or award.

6.2.2 Vendor should type or electronically enter the information into the Pricing Pages spreadsheet to prevent errors in the evaluation. Vendor should not place formulas or any type of Excel calculations into the List Price column, only the actual bid price per Contract Item. In most cases, the Pricing Pages are available in wvOASIS within the solicitation

REQUEST FOR QUOTATION
Asphalt Material, Delivery, & Labor by Vendor

attachments; however, Vendors may request an electronic copy of the Pricing Page spreadsheets for bid purposes by sending an email request to the following address: DOTProcurement@wv.gov.

6.2.3 Changing a column or row description, Contract Item description, or unit of measure on **ATT A** or **ATT B** shall result in disqualification of the Contract Item bid on the altered line. In circumstances when all Contract Items must be bid for bid evaluation and contract award, the disqualification of any Contract Item will result in the disqualification of the entire bid.

6.2.4 Submitting Pricing Pages other than those provided with this solicitation, as described in Section 6.2, shall result in disqualification of the Vendor's bid in its entirety.

6.3 Plant Information Forms, Attachment C ("ATT C") and Attachment D ("ATT D"): There are two (2) Plant Information Forms that must be submitted with corresponded Pricing Pages at the time of bid: **Attachment C Asphalt Plant Information Form (ATT C)** identifies the Asphalt Plant and **Attachment D Stone Plant Information Form (ATT D)** identifies the Stone Plant for shoulder stone placement.

All Plant Information Forms shall be completed by Vendors and shall identify WVDOH Approved Plants, as amended, supplying materials associated with bid items on the Pricing Pages. Plant Information Forms shall include:

- Name of Vendor submitting the Plant Information Form as part of bid.
- The plant name.
- Plant location 911 address or the most recent physical street address, city, and state.
- Counties the listed plant will supply materials to.

If the Vendor fails to provide the Asphalt (ATT C) or Stone (ATT D) Plant Information Form, identifying all plants from which asphalt or stone will be pulled from, their bid will be disqualified.

6.4 Contract Award Transition: Upon award of this Contract, the WVDOH Operations Division will announce the effective date of use of this contract to the Districts and the Vendors, whether it is by the effective date, the completed and encumbered date, or an established date by the WVDOH. Upon the announced effective date of use, any ADO issued prior to the award of the contract shall remain in effect and should not be cancelled until that ADO is filled; however, after ten (10) working days of Districts and Vendors notice, any ADO that has not been completely filled by the Vendors shall NOT be completed, and a

REQUEST FOR QUOTATION
Asphalt Material, Delivery, & Labor by Vendor

cancellation notice will be sent to that Vendor from the issuing District for cancellation of the balance of that ADO only. No ADO from a prior Contract should be held open by the Districts or the Vendors longer than ten (10) working days after the effective date of use is announced for the new contract.

7. ORDERING AND PAYMENT:

7.1 Ordering: Vendor shall accept orders through regular mail, facsimile, email, or any other written forms of communication. Vendor shall maintain and keep current its phone numbers, fax number, email address, locations, and ordering/billing/payment addresses with the WVDOH and in wvOASIS. Vendor may, but is not required to, accept online orders through a secure internet ordering portal/website. If Vendor has the ability to accept online orders, it should include in its response a brief description of how Agencies may utilize the online ordering system. Vendor shall ensure that its online ordering system is properly secured prior to processing Agency orders online.

7.2 Agency Delivery Order: District personnel must issue an ADO from wvOASIS for specific quantities of materials based on each project's requirements and detailing the need and location information of work to be completed per Contract Items, as well as the start and end dates, which will become the agreed upon official start and end dates. The ADO must be created in wvOASIS and approved to "Final", prior to placing the order with the Vendor. The District is responsible for creating the ADO in OASIS and is required to submit the approved order, in writing, directly to the vendor via mail, email or fax. **Verbal communication with the Vendor is not considered an official order.** In the event the Vendor denies an order or if there are changes to an ADO, the District must process a change order to the approved ADO issued from wvOASIS.

Emergencies shall be prominently noted on the ADO. Once complete, the ADO shall be sent to Vendor via fax, email, or mail.

7.2.1 Lead Time: The WVDOH should plan accordingly to allow the Contractor a minimum of 14 calendar days prior to the date of the agreed upon start date on the ADO to allow Vendor to mobilize and begin work.

7.3 Payment: Upon completion of the work indicated on the Delivery Order, Vendor shall accept payment in accordance with the payment procedures of the State of West Virginia. The State of West Virginia currently utilizes a Purchasing Card program, administered under contract by a banking institution, as well as Electronic Funds Transfer as methods to process payment for goods and services. The Vendor shall accept the State of West Virginia's Purchasing Card and Electronic Funds Transfer for payment of orders under this Contract. Electronic

REQUEST FOR QUOTATION
Asphalt Material, Delivery, & Labor by Vendor

Funds Transfer for payment is available through the WV State Auditor's Office. The Vendor may visit the WV State Auditor's website (www.wvsao.gov) for all necessary forms and instructions. Payment method may be dictated at WVDOH's discretion.

8. PROJECT ACCEPTANCE, DELIVERY AND RETURN:

- 8.1 Project Acceptance and Written Verification of Receipt:** Upon receipt of an ADO, the Vendor shall advise the WVDOH in writing within five (5) calendar days of their acceptance or refusal of the ADO. As verification of receipt, **Vendor must provide written acknowledgement of any Delivery Orders and any Revisions/Modifications thereto sent by WVDOH.** Failure to provide the WVDOH with written acknowledgement of any Delivery Orders/Revisions within five days of the Order being sent shall be considered refusal of the Delivery Order. Upon Vendor's acceptance, WVDOH should submit an ADO in wvOASIS and provide the Vendor with the ADO number for their reference.

In the event of refusal, the WVDOH at its own discretion shall cancel the ADO and may seek to obtain the requested goods or services from another low bid Vendor or proceed with an Emergency Purchase from the open market. A Vendor refusing an ADO forfeits their interest in the ADO. For example, a Vendor cannot decline work offered as lowest bid at Plant A with the expectation that the same work will be reoffered to them at Plant B at a higher bid price, even if Plant B is the next low bid. While it is at the discretion of the Vendor to choose which plant to pull material from, the lowest bid price must still be honored.

- 8.2 Negotiation of Dates:** The WVDOH shall have the option to negotiate the project's tentative start and end dates with the Vendor. **Project work shall be continuous to completion unless otherwise approved in writing by the WVDOH District Engineer or their designee.**
- 8.3 Delivery Time:** The Vendor shall mobilize, commence, and complete work delivery in accordance with the WVDOH's written Delivery Order, per project. Any changes must be communicated by the Vendor in writing to the WVDOH District Engineer or their designee. The Vendor shall work in an efficient manner in effort to keep traffic delay to a minimum and traffic must be adequately and safely accommodated. Vendor shall ship/provide all orders in accordance with the dates assigned to each project per the Delivery Order and shall not hold orders until a minimum delivery quantity is met. **No Vendor is authorized to ship project related goods or begin work/services, nor is the WVDOH authorized to receive materials, prior to the issuance of a Delivery Order.**

**REQUEST FOR QUOTATION
Asphalt Material, Delivery, & Labor by Vendor**

8.4 Late Delivery: The Agency placing the order under this Contract must be notified in writing if orders will be delayed for any reason. Any delay in delivery that could cause harm to an Agency will be grounds for cancellation of the delayed order, and/or obtaining the items ordered from a third party. An Agency placing an ADO under this Contract must be notified **in writing by the Vendor no later than five (5) business days prior to the scheduled start date from the Agency's order.** Any failure to notify, acknowledge receipt of WVDOH's written ADO/revisions, resulting in delivery delay or failure to start or complete the project per the WVDOH scheduled due dates, may be determined by the WVDOH at its sole discretion as harmful to the Agency and as such, shall result in WVDOH's cancellation of the ADO and application of Liquidated Damages.

Any Agency seeking to obtain items from a third party under this provision must first obtain approval of the WVDOH Procurement Division.

8.4.1 Liquidated Damages: If the Vendor's work completion or correction of deficient work exceeds the ADO completion due date/timeframe, the Vendor shall agree that no extension of contract time will be granted unless Liquidated Damages are applied by the WVDOH in the form of an off-set reduction to the total amount of the Vendor's final invoice. The WVDOH shall calculate Liquidated Damages per project beginning on day one after the WVDOH's specified Delivery Order due date, in accordance with this Section, the contract's Terms and Conditions, and the Standard Specs Section 108.7, as amended, in the amounts in Table 108.7.1 from the Standard Specs as follows:

**TABLE 108.7.1
Schedule of Liquidated Damages**

| Original Contract Amount | | Daily Charges Per Calendar Day |
|--------------------------|------------------|-----------------------------------|
| For More Than | To and Including | |
| \$0 | \$500,000 | \$350 |
| \$500,000 | \$2,000,000 | \$650 |
| \$2,000,000 | \$10,000,000 | \$1,600 |
| \$10,000,000 | \$25,000,000 | \$3,100 |
| \$25,000,000 | | \$4,200 |

8.5 Adverse Weather Conditions: Unsuitable/adverse/inclement weather conditions may dictate the work schedule. It is preferred that operations be suspended immediately when an inclement weather event begins or if the WVDOH District Engineer or their designee determines that an inclement weather event is imminent. If working conditions are dangerous or unsuitable for the WVDOH, Vendor, or general public, work shall be suspended by the WVDOH Engineer or their designee. If needed, revision to the project's start and end date may be

REQUEST FOR QUOTATION
Asphalt Material, Delivery, & Labor by Vendor

negotiated by the Vendor and the WVDOH Engineer or their designee. After a weather-related suspension of work, the WVDOH District Engineer or their designee shall determine and convey in writing, such ADO changes and when work shall commence/resume, followed by the Vendor's written acknowledgement, per Section 8.1 of this Contract Solicitation.

- 8.6 Delivery Payment/Risk of Loss:** Standard order delivery shall be F.O.B. Vendor's plant location. **Asphalt Haul by Vendor, Contract Items 27 and 28,** shall be requested on the ADO. Vendor shall include the cost/discount of standard order delivery charges in its bid pricing and is not permitted to charge the Agency separately for such delivery.
- 8.7 Project Acceptance Criteria:** The WVDOH District Engineer or their designee shall have final acceptance of the work done by the Vendor, per project. Any work found by the WVDOH District Engineer or their designee not performed in accordance with these Contract Specifications and the Standard Specs, as amended, and/or found deficient and unacceptable by visual inspection will be rejected and, at the Vendor/Contractor's expense, will be removed and replaced by the Vendor with work being continual until the Vendor's deficient work corrections are completed and deemed acceptable and approved by the WVDOH District Engineer or their designee. Under no circumstance shall the Vendor's deficiency corrections exceed twenty (20) calendar days unless otherwise declared in writing by the WVDOH District Engineer or their designee, subject to Liquidated Damages as per Section 8.4.1 of these Contract Specifications.
- 8.8 Rejection of Unacceptable Contract Items:** The decision of the WVDOH District Engineer or their designee regarding materials, workmanship, quality etc., shall be final per Standard Specs Section 105, as amended.

9. VENDOR DEFAULT:

- 9.1** The following shall be considered a vendor default under this Contract.
- 9.1.1** Failure to provide Contract Items in accordance with the requirements contained herein.
- 9.1.2** Failure to comply with other specifications and requirements contained herein.
- 9.1.3** Failure to comply with any laws, rules, and ordinances applicable to the Contract Services provided under this Contract.

REQUEST FOR QUOTATION
Asphalt Material, Delivery, & Labor by Vendor

- 9.1.4 Failure to remedy deficient performance upon request.
- 9.2 The following remedies shall be available to Agency upon default.
 - 9.2.1 Immediate cancellation of the Contract.
 - 9.2.2 Immediate cancellation of one or more release orders issued under this Contract.
 - 9.2.3 Any other remedies available in law or equity.

10. MISCELLANEOUS:

- 10.1 **No Substitutions:** Vendor shall supply only Contract Items submitted in response to the Solicitation unless a Contract modification is approved in accordance with the provisions contained in this Contract.
- 10.2 **Vendor Supply:** Vendor must carry sufficient inventory of the Contract Items being offered to fulfill its obligations under this Contract. By signing its bid, Vendor certifies that it can supply the Contract Items contained in its bid response.
- 10.3 **Vendor's Invoices:** Invoices for materials, **Contract Items 1 through 17, 65, 66, and 68**, must be submitted separately from all other items. All other items shall be submitted on a separate invoice. The Vendor's invoices must be submitted as an original containing the following information:
 - All weigh ticket numbers for material delivered and cuttings hauled during the invoice period.
 - The WVDOH ADO number and the Vendor's contract number.
 - Total quantity and unit price with the total cost of each type of material furnished.
 - No payment will be made to a Contractor for **Daytime Paving Mobilization, Contract Item 33**, unless the quantity is less than 500 tons or **Nighttime Paving Mobilization, Contract Item 34** unless the ADO directs that paving is to be done at night.
- 10.4 **Reports:** Vendor shall provide the Agency with quarterly reports, annual summaries, and/or monthly reports as requested by the Agency and/or the West Virginia Purchasing Division showing quantities, total dollar value of the Contract Items purchased, ordered, shipped & invoiced with dates in spreadsheet format as defined by the Agency. Failure to supply such reports may be grounds for cancellation of this Contract.

REQUEST FOR QUOTATION
Asphalt Material, Delivery, & Labor by Vendor

10.5 Contract Manager: During its performance of this Contract, Vendor must designate and maintain a primary contract manager responsible for overseeing Vendor's responsibilities under this Contract. The Contract Manager must be available during normal business hours to address any customer service or other issues related to this Contract. Vendor should list its Contract Manager and his or her contact information below.

Contract Manager: Joseph Meadows
Telephone Number: 304-425-5445
Fax Number: 304-425-6535
Email Address: sales@jandmpaving.com

Vendor shall inform the Agency in writing of any changes to the information provided above within ten (10) calendar days of such changes. Failure to comply may be grounds for cancellation of this contract.

**Asphalt Materials Delivery Labor by Vendor
ATTACHMENT A PRICING PAGE (ATT A)**

Vendor Name: _____

Vendor's Sourced Asphalt Plant(s): _____

Vendor Instructions: Vendor shall mark with an "X" the counties that correspond with the Asphalt Plant(s) bid prices on this page. If Vendor has varied pricing per county, Vendor shall complete a separate set of Pricing Pages (ATT A and ATT B if different) for each county pricing set. Vendor must complete TWO (2) Pricing Pages (ATT A and ATT B) as well as TWO (2) Plant Information Forms (ATT C and ATT D) with bid. **Bids submissions that do not include ATT A, ATT B, ATT C and ATT D WILL BE DISQUALIFIED.**

This is a multiple vendor award contract. All qualifying vendor meeting the contract specifications will be awarded with a contract. The low bid vendor per project will be determined at the time of need, as per Section 6.1 of the Contract Specifications. Estimated quantities are not available.

| | | | | | | | | | |
|----------------------------------|----------------------------------|------------------------------------|-------------------------------------|------------------------------------|-----------------------------------|----------------------------------|-------------------------------------|-------------------------------------|-----------------------------------|
| <input type="checkbox"/> Boone | <input type="checkbox"/> Cabell | <input type="checkbox"/> Calhoun | <input type="checkbox"/> Doddridge | <input type="checkbox"/> Berkeley | <input type="checkbox"/> Brooke | <input type="checkbox"/> Barbour | <input type="checkbox"/> Pendleton | <input type="checkbox"/> Fayette | <input type="checkbox"/> McDowell |
| <input type="checkbox"/> Clay | <input type="checkbox"/> Lincoln | <input type="checkbox"/> Jackson | <input type="checkbox"/> Harrison | <input type="checkbox"/> Grant | <input type="checkbox"/> Hancock | <input type="checkbox"/> Braxton | <input type="checkbox"/> Pocahontas | <input type="checkbox"/> Greenbrier | <input type="checkbox"/> Mercer |
| <input type="checkbox"/> Kanawha | <input type="checkbox"/> Logan | <input type="checkbox"/> Pleasants | <input type="checkbox"/> Marion | <input type="checkbox"/> Hampshire | <input type="checkbox"/> Marshall | <input type="checkbox"/> Gilmer | <input type="checkbox"/> Randolph | <input type="checkbox"/> Monroe | <input type="checkbox"/> Raleigh |
| <input type="checkbox"/> Mason | <input type="checkbox"/> Mingo | <input type="checkbox"/> Ritchie | <input type="checkbox"/> Monongalia | <input type="checkbox"/> Hardy | <input type="checkbox"/> Ohio | <input type="checkbox"/> Lewis | <input type="checkbox"/> Tucker | <input type="checkbox"/> Nicholas | <input type="checkbox"/> Wyoming |
| <input type="checkbox"/> Putnam | <input type="checkbox"/> Wayne | <input type="checkbox"/> Roane | <input type="checkbox"/> Preston | <input type="checkbox"/> Jefferson | <input type="checkbox"/> Tyler | <input type="checkbox"/> Upshur | | <input type="checkbox"/> Summers | |
| | | <input type="checkbox"/> Wirt | <input type="checkbox"/> Taylor | <input type="checkbox"/> Mineral | <input type="checkbox"/> Wetzel | <input type="checkbox"/> Webster | | | |
| | | <input type="checkbox"/> Wood | | <input type="checkbox"/> Morgan | | | | | |

| Contract Item # | Contract Item Description | Unit of Measure | List Price |
|-----------------|--|-----------------|------------|
| 1 | Asphalt Section 401 - Base I | TON | |
| 2 | Asphalt Section 401 - 25mm Superpave | TON | |
| 3 | Asphalt Section 401 - Base II | TON | |
| 4 | Asphalt Section 401 - Patch and Level | TON | |
| 5 | Asphalt Section 401 - Wearing IV | TON | |
| 6 | Asphalt Section 402 - Wearing IV | TON | |
| 7 | Asphalt Section 401 - 19mm Superpave | TON | |
| 8 | Asphalt Section 401 - Scratch Course | TON | |
| 9 | Asphalt Section 402 - 9.5mm Superpave | TON | |
| 10 | Asphalt Section 401 - Wearing 1 | TON | |
| 11 | Asphalt Section 402 - Wearing 1 | TON | |
| 12 | Asphalt Section 401 - 4.75mm Superpave | TON | |
| 13 | Asphalt Section 402 - 4.75mm Superpave | TON | |
| 14 | Asphalt Section 401 - Wearing III | TON | |
| 15 | Asphalt Section 402 - Wearing III | TON | |
| 16 | Asphalt Section 401 - 12.5mm Superpave | TON | |
| 17 | Asphalt Section 402 - 12.5mm Superpave | TON | |
| 18 | Shoulder Stone Placement for Asphalt Section 307 - Class 10 | TON | |
| 19 | Shoulder Stone Mobilization - Complete on ATT B | LUMP SUM | ----- |
| 20 | Haul by Vendor Shoulder Stone Placement - First Ton Mile | TON MILE | |
| 21 | Haul by Vendor Shoulder Stone Placement - Each Additional Ton Mile | TON MILE | |
| 22 | Surcharge for PG Binder 58-28S | TON | |
| 23 | Surcharge for PG Binder 64H minus 22 | TON | |
| 24 | Surcharge for PG Binder 64E minus 22 ordered in 400 Ton increments | TON | |
| 25 | ESAL Surcharge - 3 million to 20 million ESALs | TON | |
| 26 | ESAL Surcharge - Greater than 20 million ESALs | TON | |
| 27 | Asphalt Haul by Vendor - First Ton Mile | TON MILE | |
| 28 | Asphalt Haul by Vendor - Each Additional Ton Mile | TON MILE | |
| 29 | Laydown of Material Items #1-17, Each Site 0-100 Tons | TON | |
| 30 | Laydown of Material Items #1-17, Each Site 101 to 200 Tons | TON | |
| 31 | Laydown of Material Items #1-17, Each Site 201 to 500 Tons | TON | |
| 32 | Laydown of Material Items #1-17, Each Site 501 Tons or Greater | TON | |
| 33 | Daytime Paving Mobilization - Complete on ATT B | LUMP SUM | ----- |
| 34 | Nighttime Paving Mobilization - Complete on ATT B | LUMP SUM | ----- |
| 35 | Excavation for Shoulder Paving - 0 to 1000 Sq. Yards | SY | |

ATTACHMENT D

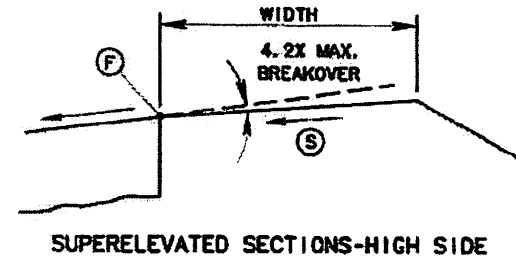
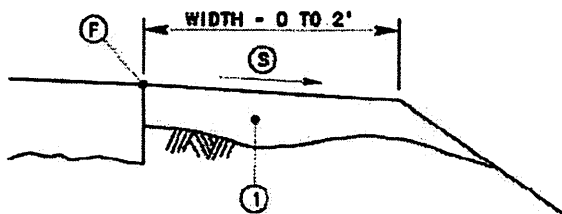
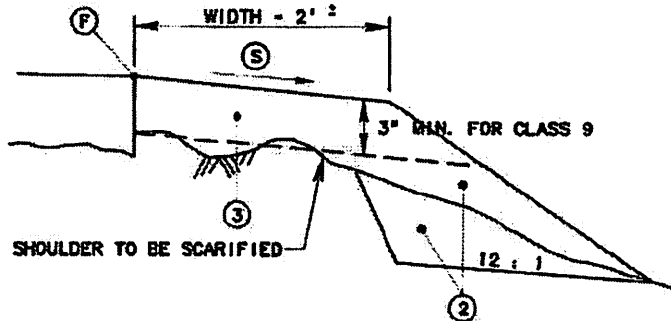
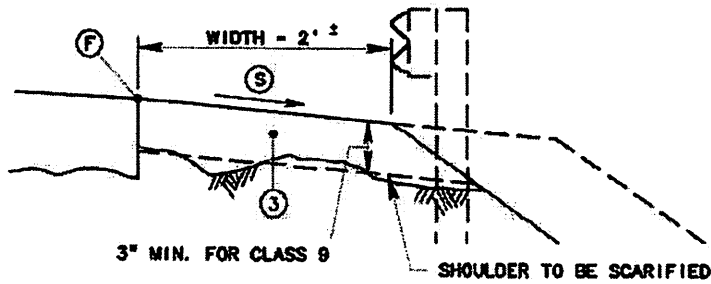

LEGEND

- ① ITEM 401001- , HOT-MIX ASHALT BASE COURSE, TYPE
- ② ITEM 211008-000, ROCK BORROW EXCAVATION
The intent of this item is to provide proper foundation for the shoulder while restoring the original shoulder width reduced by erosion. Additional material, as directed by the Engineer, may be required by recent erosion and will be paid for as 211008-000. Excavation of benches for placing, 211008-000 will be included in 211008-000.
- ③ ITEM 307005-001, AGGREGATE BASE COURSE, CLASS 10
This item includes any necessary removal of existing shoulder material to a minimum of 3" below the finished pavement elevation when Class 9 aggregate is specified. Material removed shall be reused within the project limits or wasted as directed by the Engineer. Scarifying shall be in accordance with Section 308.3.1 of the Specifications.
- (F) FINISHED PAVEMENT ELEVATION
- (S) SHOULDER SLOPE
Normal Sections : 6 %
Superelevated : Match rate of superelevation or reduce as shown above
Minimum slope to be 1/4" per foot, on low side of superelevation.
Paved Shoulders : 4 X or superelevated.

THE WEST VIRGINIA DEPARTMENT OF TRANSPORTATION DIVISION OF HIGHWAYS

SHOULDER RECONSTRUCTION

| Public Works Div. | State Dist. No. | State Project No. | Federal Project No. | County |
|-------------------|-----------------|-------------------|---------------------|--------|
| W. V. | | | | |

ATTACHMENT C

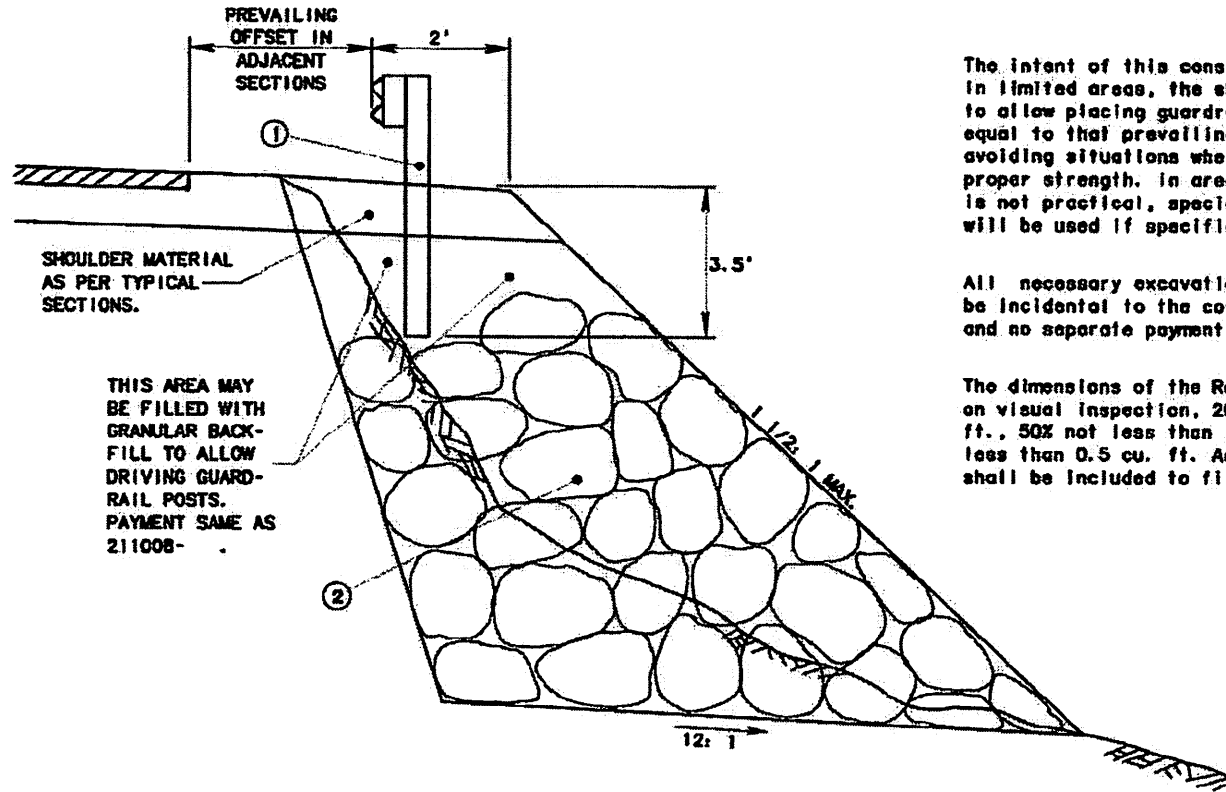

The intent of this construction is to restore, in limited areas, the shoulder width sufficiently to allow placing guardrail at an offset nearly equal to that prevailing in adjacent sections avoiding situations where posts would not provide proper strength. In areas where such construction is not practical, special designs such as piling will be used if specified in the plans.

All necessary excavation of the fill bench will be incidental to the cost of item 211008-000, and no separate payment will be made.

The dimensions of the Rock Borrow shall be, based on visual inspection, 20% not less than 1.5 cu. ft., 50% not less than 1.0 cu. ft. and 30% not less than 0.5 cu. ft. Adequate rock fragments shall be included to fill the rock voids.

THIS AREA MAY BE FILLED WITH GRANULAR BACK-FILL TO ALLOW DRIVING GUARD-RAIL POSTS. PAYMENT SAME AS 211008-

- ① ITEM 607001-001, TYPE I GUARDRAIL, CLASS (AS SHOWN ON PLANS)
- ② ITEM 211008-000, ROCK BORROW EXCAVATION

THE WEST VIRGINIA DEPARTMENT OF TRANSPORTATION DIVISION OF HIGHWAYS
RESTORING SHOULDERS FOR GUARDRAIL

| Public Works Div. | State Dist. No. | State Project No. | Federal Project No. | County |
|-------------------|-----------------|-------------------|---------------------|--------|
| W. V. | | | | |

ATTACHMENT E

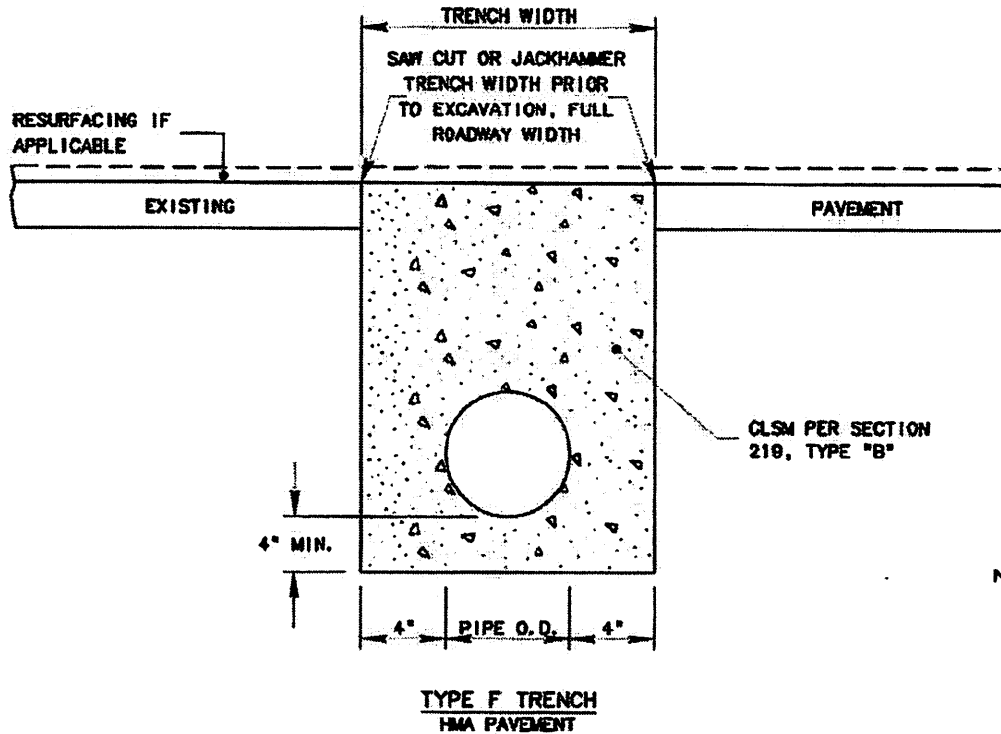

WHEN NO OVERLAY IS SPECIFIED THE CONTROLLED LOW-STRENGTH MATERIAL (CLSM) SHALL BE A MIN. OF 2000 psi FOR DGH PIPES ONLY. NOT TO BE USED FOR UTILITY PIPES.

NOTE: IF TYPE F TRENCH IS USED WHERE THERE IS NO EXISTING OR PROPOSED INLET, THE CLSM SHALL BE POURED FULL DEPTH 2' PAST EACH E.P. THE PIPE SHALL BE ENCASED IN 4" OF CLSM AN ADDITIONAL 10' MAX. BEYOND E.P. IF THERE IS AN EXISTING OR PROPOSED INLET THE CLSM SHALL BE POURED FULL DEPTH TO THE INLET.

THE WEST VIRGINIA DEPARTMENT OF TRANSPORTATION DIVISION OF HIGHWAYS

REPAVING PIPE TRENCHES IN PAVED SHOULDER

| Public Roads Div. | State Dist. No. | State Project No. | Federal Project No. | County |
|-------------------|-----------------|-------------------|---------------------|--------|
| W. V. | | | | |

FIGURE 2

TEMPORARY WEDGES AT HEEL-INS

THE CONTRACTOR MAY ELECT TO CUT THE REQUIRED HEEL-INS SUCH THAT TRAFFIC MUST BE MAINTAINED OVER THE HEEL-IN AREAS PRIOR TO THE PLACEMENT OF THE PERMANENT HMA MATERIAL. IF THE CONTRACTOR CHOOSES THIS METHOD AS AN ALTERNATE TO CUTTING THE HEEL-INS AND BACKFILLING WITH PERMANENT HMA PRIOR TO RESTORING TRAFFIC. IT SHALL BE THE CONTRACTORS RESPONSIBILITY TO PLACE TEMPORARY HMA WEDGES 10 FEET IN LENGTH FOR EACH 1 INCH OF EXISTING SURFACE REMOVED AT THE VERTICAL FACE. FOR EXAMPLE, IF 2 INCHES ARE REMOVED AT THE VERTICAL FACE, THE TEMPORARY HMA WEDGE SHALL BE 20 FEET IN LENGTH. THE WEDGES SHALL BE CONSTRUCTED OF ITEM 401001-011, TYPE 19, PLACED AND COMPACTED IN ACCORDANCE WITH SECTION 401.14. THESE TEMPORARY WEDGES SHALL BE REMOVED IMMEDIATELY PRIOR TO PLACING THE PERMANENT SURFACE. THE COST OF THIS WORK WILL BE INCLUDED IN VARIOUS PAVEMENT ITEMS.

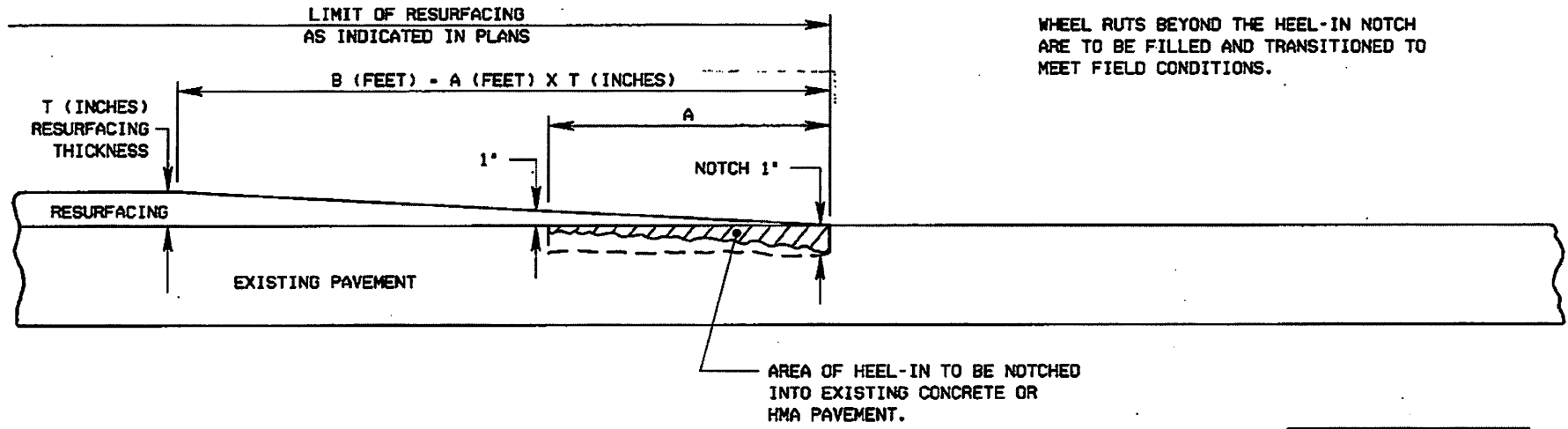

WHEEL RUTS BEYOND THE HEEL-IN NOTCH ARE TO BE FILLED AND TRANSITIONED TO MEET FIELD CONDITIONS.

AREA OF HEEL-IN TO BE NOTCHED INTO EXISTING CONCRETE OR HMA PAVEMENT.

| POSTED SPEED LIMIT | A |
|--------------------|-----|
| 25 MPH | 12' |
| 30 TO 35 MPH | 14' |
| 40 TO 45 MPH | 16' |
| 50 TO 55 MPH | 18' |
| 60 TO 70 MPH | 25' |

1. PAYMENT FOR HEEL-IN TO BE INCLUDED IN VARIOUS PAY ITEMS OF THIS PROJECT
2. THIS DETAIL TO BE USED AT TERMINI OF RESURFACING PROJECTS AND AT ALL TERMINI FOR SKIP RESURFACING PROJECTS.
3. THIS DETAIL TO BE USED AT LOCATIONS FOR HEEL-IN INTERSECTIONS OF THIS PROJECT.
4. THE FOLLOWING NUMBER(S) OF HEEL-INS FOR THE MAINLINE ON THIS PROJECT SHALL BE:
 PERPENDICULAR
 SKEWED AT

THE WEST VIRGINIA DEPARTMENT OF TRANSPORTATION DIVISION OF HIGHWAYS
RESURFACING HEEL-IN DETAIL

| PUBLIC ROADS DIV. | STATE DIST. NO. | STATE PROJECT NO. | FEDERAL PROJECT NO. | COUNTY |
|-------------------|-----------------|-------------------|---------------------|--------|
| W. V. | | | | |

ATTACHMENT G

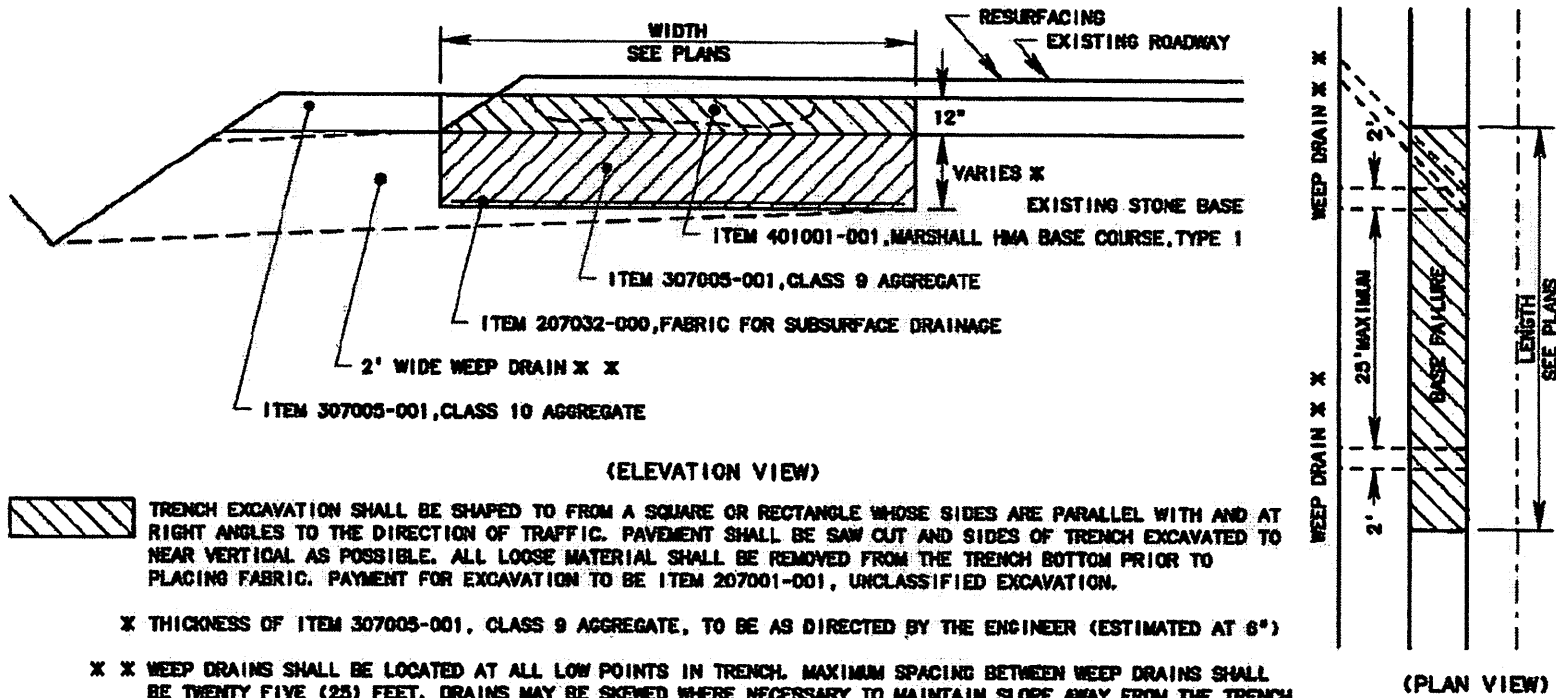

 TRENCH EXCAVATION SHALL BE SHAPED TO FROM A SQUARE OR RECTANGLE WHOSE SIDES ARE PARALLEL WITH AND AT RIGHT ANGLES TO THE DIRECTION OF TRAFFIC. PAVEMENT SHALL BE SAW CUT AND SIDES OF TRENCH EXCAVATED TO NEAR VERTICAL AS POSSIBLE. ALL LOOSE MATERIAL SHALL BE REMOVED FROM THE TRENCH BOTTOM PRIOR TO PLACING FABRIC. PAYMENT FOR EXCAVATION TO BE ITEM 207001-001, UNCLASSIFIED EXCAVATION.

* THICKNESS OF ITEM 307005-001, CLASS 9 AGGREGATE, TO BE AS DIRECTED BY THE ENGINEER (ESTIMATED AT 6")

* * WEEP DRAINS SHALL BE LOCATED AT ALL LOW POINTS IN TRENCH. MAXIMUM SPACING BETWEEN WEEP DRAINS SHALL BE TWENTY FIVE (25) FEET. DRAINS MAY BE SKEWED WHERE NECESSARY TO MAINTAIN SLOPE AWAY FROM THE TRENCH AREA. PAYMENT FOR WEEP DRAINS TO BE INCLUDED IN ITEM 307005-001, CLASS 9 AGGREGATE BASE COURSE.

THE WEST VIRGINIA DEPARTMENT OF TRANSPORTATION DIVISION OF HIGHWAYS

BASE FAILURE REPAIR DETAIL

| Public Road Dist. | State Dist. No. | State Project No. | Federal Project No. | County |
|-------------------------|-----------------------|-------------------------|---------------------------|--------|
| W. V. | | | | |

ATTACHMENT H

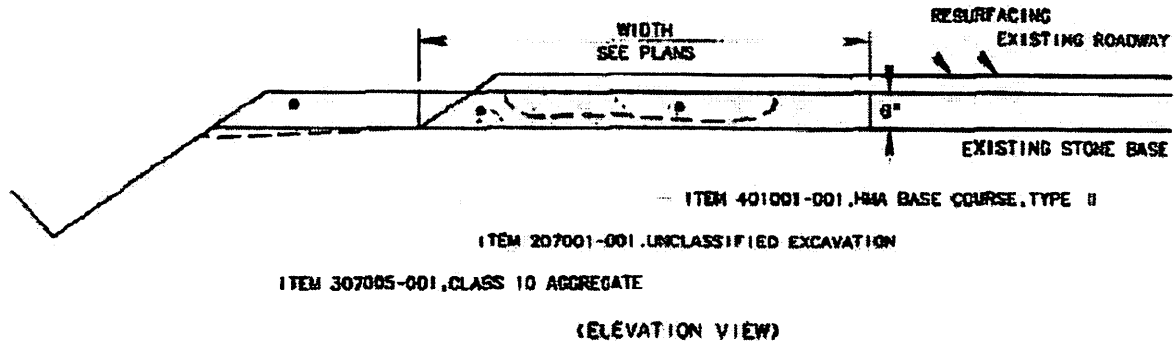

TRENCH EXCAVATION SHALL BE SHAPED TO FORM A SQUARE OR RECTANGLE WHOSE SIDES ARE PARALLEL WITH AND AT RIGHT ANGLES TO THE DIRECTION OF TRAFFIC. PAVEMENT SHALL BE SAW CUT AND SIDES OF TRENCH EXCAVATED TO NEAR VERTICAL AS POSSIBLE. ALL LOOSE MATERIAL SHALL BE REMOVED FROM THE TRENCH BOTTOM PRIOR TO PLACING HMA.

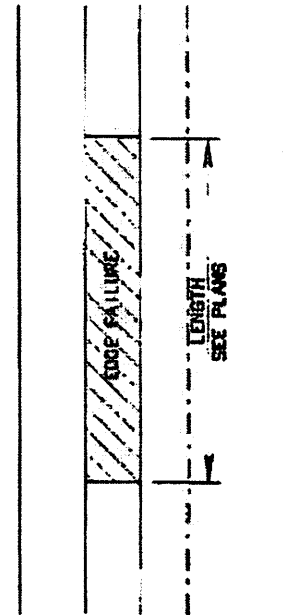

(PLAN VIEW)

THE WEST VIRGINIA DEPARTMENT OF TRANSPORTATION DIVISION OF HIGHWAYS

EDGE FAILURE REPAIR DETAIL

| Public Works Div. | State Dist. No. | State Project No. | Federal Project No. | County |
|-------------------|-----------------|-------------------|---------------------|--------|
| W. V. | | | | |

ATTACHMENT F

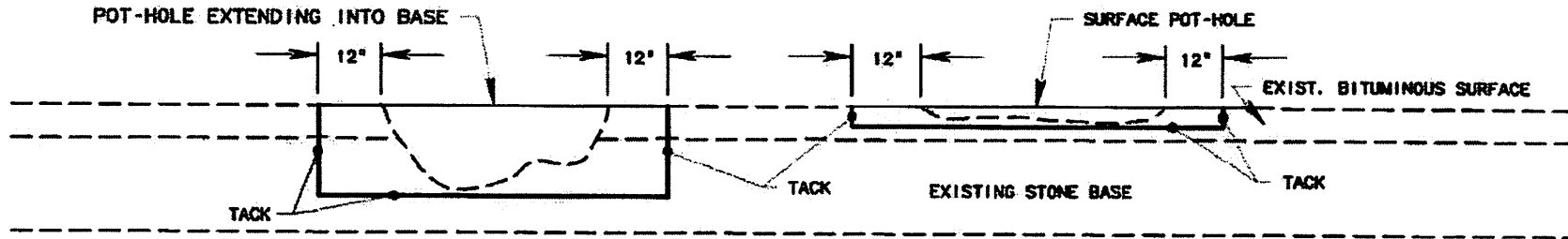

(ELEVATION VIEW)

THE SIDES AND BOTTOMS MUST BE CLEANED AFTER THE HOLE IS SHAPED TO FROM A SQUARE OR RECTANGLE WHOSE SIDES ARE PARALLEL OR AT RIGHT ANGLES TO THE DIRECTION OF TRAFFIC WITH THE EDGES NEAT AND AS NEARLY VERTICAL AS POSSIBLE.

THE EXISTING BASE WILL BE REPLACED WITH HOT-LAID ASPHALT.

THE REMAINING SURFACE POT-HOLE WILL BE FILLED WITH HOT-LAID ASPHALT BASE COURSE TYPE MEETING REQUIREMENTS OF SECTION 401 OF THE SPECS. ENOUGH MATERIAL MUST BE USED TO BRING THE SURFACE OF REPAIR ABOUT 1/8" ABOVE THE LEVEL OF THE ORIGINAL PAVEMENT TO ALLOW FOR FURTHER COMPACTION BY TRAFFIC AND/OR RESURFACING.

THE WEST VIRGINIA DEPARTMENT OF TRANSPORTATION DIVISION OF HIGHWAYS

POT - HOLE REPAIR DETAIL

| Public Roads Div. | State Dist. No. | State Project No. | Federal Project No. | County |
|-------------------------|-----------------------|-------------------------|------------------------|--------|
| W. V. | | | | |

FIGURE 1

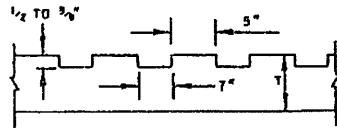

ALTERNATE SECTION B-B
(SAWED RUMBLE STRIP)

RUMBLE STRIP FOR HOT MIX ASPHALT SHOULDERS

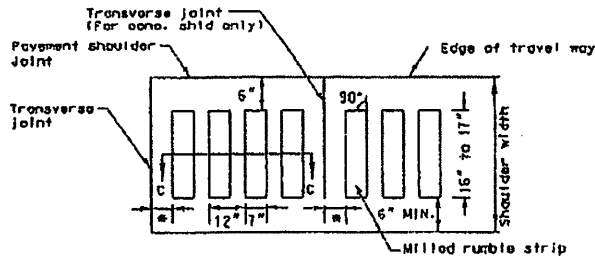

- * 7 1/2" For conc. shld.
- 2 1/2" For asphalt shld.

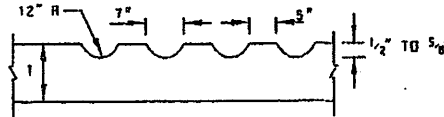

SECTION C-C
(MILLED RUMBLE STRIP)

MILLED RUMBLE STRIP FOR PORTLAND CEMENT AND HOT MIX ASPHALT SHOULDERS

NOTES:

RUMBLE STRIP PLACEMENT WILL BE CONTINUOUS ON HOT-MIX ASPHALT SHOULDERS, EXCEPT AS NOTED BELOW.

RUMBLE STRIPS SHALL NOT BE PLACED AT THE FOLLOWING AREAS FOR HOV-3 FREEWAY PROJECTS, ONLY:

ON SHOULDERS OF NARROW CLEARING LANES THAT ARE 9' OR LESS IN WIDTH, POINT OF TRAFFIC FLOW IN THE SHOULDER TRANSITION AREA, POINT OF TRAFFIC FLOW, BETWEEN A FULL PAVED SHOULDER WIDTH OF 10' AND NARROW BRIDGE WIDTH OF 4'.

RUMBLE STRIP WIDTH IS TO BE 2', EXCEPT MILLED RUMBLE STRIP WIDTH WILL BE 10"-17".

RUMBLE STRIPS MAY BE SAWED OR MILLED UNLESS OTHERWISE INDICATED. THE TOP OF THE RUMBLE STRIPS WILL BE NO HIGHER THAN THE TOP SURFACE OF THE PAVEMENT. ANY FAULTY OR IMPROPERLY INSTALLED RUMBLE STRIPS WILL BE CORRECTED BY THE CONTRACTOR AT HIS EXPENSE.

MILL/SAW SHOULDER RUMBLE STRIPS AS INDICATED BY USING A MACHINE CAPABLE OF PROVIDING A SMOOTH CUT WITHOUT TEARING OR SHAGGING, AND PROVIDING RUMBLE STRIPS AS INDICATED. EQUIP MACHINE WITH GUIDES TO PROVIDE UNIFORMITY AND CONSISTENCY IN ALIGNMENT OF EACH CUT WITH RESPECT TO ROADWAY. ALL SHOULDER RUMBLE STRIPS TO HAVE FRESH DIMENSIONS WITHIN TOLERANCES SPECIFIED. ALL SHOULDER RUMBLE STRIPS ON NEW CONCRETE SHOULDERS AFTER CURING, ALIGNMENT OF PATTERN EDGE WILL BE RANDOMLY VERIFIED AND CHECKED. UNDESIRABLE MILLING OPERATIONS IF SATISFACTORY RESULTS ARE NOT BEING OBTAINED AND SHIRT AN ALTERNATE CONSTRUCTION PLAN TO THE ENGINEER FOR APPROVAL. AT END OF EACH WORKING DAY, MOVE ALL EQUIPMENT TO A LOCATION AS DIRECTED WHERE IT PRESENTS NO HAZARD TO ROADWAY TRAFFIC. REMOVE AND DISPOSE OF MILLED MATERIAL IN COMPLIANCE WITH APPLICABLE STATE REGULATIONS. REMOVE DEBRIS FROM AREAS DISTURBED BY MILLING OPERATION BEFORE OPENING ROADWAY TO TRAFFIC.

RUMBLE STRIPS IN PAVED SHOULDERS:

RUMBLE STRIPS SHALL BE MILLED OR SAWED TYPE PLACED IN SHOULDERS UNDER THE FOLLOWING CONDITIONS, IN ACCORDANCE WITH THIS SPECIAL DETAIL SHEET:

- TYPICAL SHOULDER WIDTH IS 0' OR MORE;
- MEDIAN SHOULDERS ON DIVIDED FREEWAYS, IF SHOULDER WIDTH IS 3' OR GREATER;
- SHOULDERS ADJACENT TO ONE WAY RAMPS WHICH CONNECT TO ARTERIAL ROADWAYS, IF TYPICAL SHOULDER IS 3' OR GREATER.

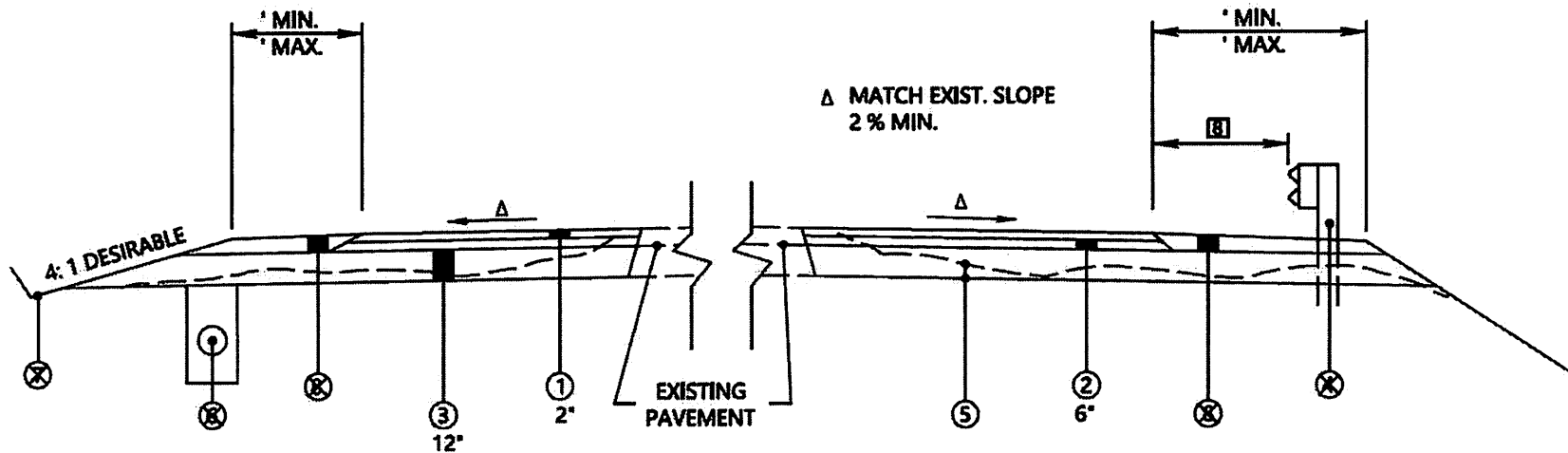

LEGEND

- ① ITEM 401002-020, MARSHALL ASPHALT WEARING COURSE, STONE OR GRAVEL, TYPE 1 OR
ITEM 401002-021, MARSHALL ASPHALT WEARING COURSE, SLAG, TYPE 1
- ② ITEM 401001-020, MARSHALL ASPHALT BASE COURSE, STONE OR GRAVEL, TYPE 1 OR
ITEM 401001-021, MARSHALL ASPHALT BASE COURSE, SLAG, TYPE 1
- ③ ITEM 307001-000, AGGREGATE BASE COURSE, CLASS 1
- ~~④ ITEM 607001-001, TYPE 1 GUARDRAIL, CLASS 1~~
- ⑤ ITEM 207001-001, UNCLASSIFIED EXCAVATION
- ~~⑥ ITEM 606025, 18 INCH UNDERDRAIN PIPE OR
ITEM 606020-001 FABRIC UNDERDRAIN, AS SPECIFIED IN PLANS~~
- ~~⑦ ITEM 229001-001, SHOULDERS AND DITCHES (SEE DETAIL PAGE 28)~~
- ~~⑧ ITEM 307005-001, AGGREGATE BASE COURSE, STONE OR GRAVEL, CLASS 10 OR
ITEM 307005-002, AGGREGATE BASE COURSE, SLAG, CLASS 10~~

NOTES:

The pavement design for this project shall be in accordance with _____ Traffic Design. The design ESAL value on this project shall be _____.

GUARDRAIL TO BE LOCATED AT THE PREVALING OFFSET IN ADJACENT SECTIONS.

THE WEST VIRGINIA DEPARTMENT OF TRANSPORTATION DIVISION OF HIGHWAYS

TYPICAL SECTION FOR BASE FAILURE-PARTIAL WIDTH

| Public Roads Div. | State Dist. No. | State Project No. | Federal Project No. | County |
|-------------------|-----------------|-------------------|---------------------|--------|
| W.V. | | | | |

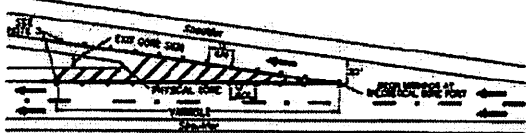

GORE AREA

NOTES:

1. MARKER PLACEMENT AT GORES ONLY WHEN SPECIFIED.
2. THE SPACING BETWEEN MARKERS IN THE GORE AREA SHOULD BE APPROXIMATELY 12' APART AND CENTERED BETWEEN THE STRIPES IF THEY ARE EXISTING.
3. END MARKERS APPROXIMATELY 20' BEYOND END GORE SIDE OR PHYSICAL CORE IF NO SIDE.
4. IF, IN ACCORDANCE WITH DETAIL NOTE 1, MONO-DIRECTIONAL LENSES ARE TO BE UTILIZED ALONG THE SECTION OF ROADWAY CONTAINING THE GORE AREA, BI-DIRECTIONAL WHITE/RED LENSES SHALL BE UTILIZED AROUND THE PERIPHERY OF THE GORE AREA. IN ADDITION, BI-DIRECTIONAL WHITE/RED LENSES SHALL BE UTILIZED FOR ALL LANE LINE LENSES BEGINNING 100' IN ADVANCE OF THE GORE SIDE AND ENDING AT THE GORE SIDE.

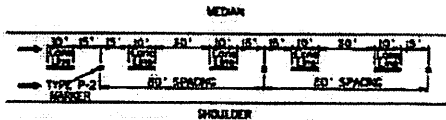

LANE LINE OF DIVIDED HIGHWAY

- NOTES:**
1. BI-DIRECTIONAL MARKERS SHOWN. MONO-DIRECTIONAL REFLECTORS MAY BE REQUIRED. SEE DETAIL NOTES.

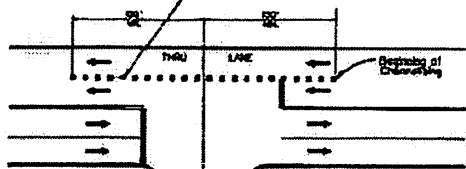
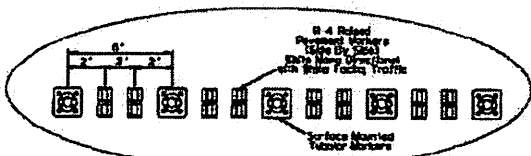

CONTINUOUS THRU LANE DELINEATION

- NOTES:**
1. LOCATION OF MARKERS ARE SHOWN ON THE PLANS.
 2. TYPE R-4 MARKERS ARE NOT TO BE APPLIED OVER PAINT STRIPES.
 3. ALL TYPE R-4 MARKERS SHALL BE INSTALLED IN ACCORDANCE WITH THE STANDARD SPECIFICATION.

DETAIL NOTES

PAVEMENT MARKERS ARE USED TO SUPPLEMENT EXISTING PAINTED MARKINGS. UNLESS OTHERWISE SPECIFIED, THE COLOR OF THE FACE OF THE REFLECTIVE MARKER LENS VIEWED BY TRAVELING MOVING IN THE CORRECT DIRECTION SHALL CONFORM TO THE COLOR OF THE MARKING WHICH THEY SUPPLEMENT UNDER BOTH DAY AND NIGHT CONDITIONS. THIS SHALL INCLUDE THE BODY OF THE MARKER FOR TYPE S-4 MARKERS. THE FOLLOWING GUIDELINES SHALL BE USED IN DETERMINING THE CORRECT ROW LENS COLOR TO BE USED FOR VARIOUS APPLICATIONS.

1. FOR THE PURPOSES OF THIS SHEET, MEDIAN WIDTH SHALL BE DEFINED AS THE WIDTH BETWEEN OPPOSING DIRECTIONS OF A DIVIDED MEDIAN, MEASURED FROM EDGE OF TRAVELED WAY TO EDGE OF TRAVELED WAY, EXCLUDING TURN LANES. MARKERS WHICH SUPPLEMENT WHITE PAVEMENT MARKINGS (LANE LINES AND CHANNELING LINES) INSTALLED ON DIVIDED HIGHWAYS HAVING A MEDIAN WIDTH OF THIRTY (30) FEET (9 METERS) OR GREATER OR MARKERS WHICH SUPPLEMENT WHITE PAVEMENT MARKINGS INSTALLED ON DIVIDED HIGHWAYS WITH A MEDIAN WIDTH LESS THAN THIRTY (30) FEET (9 METERS) AND HAVING A ROAD PHYSICAL MEDIAN BARRIER WHICH RESTRICTS VISIBILITY OF THE OPPOSING LANES, SUCH AS A CONCRETE BARRIER WALL OR A DOUBLE FACED CURBURAL BARRIER, SHALL BE REFLECTIVE IN BOTH DIRECTIONS (BI-DIRECTIONAL). IN THESE CASES, THE FRONT FACE OF THE LENS SHALL BE WHITE AND THE BACK FACE OF THE LENS SHALL BE RED. EXCEPT AS NOTED HEREIN FOR GORE AREAS AND LANE LINE MARKERS APPROACHING GORE AREAS, ALL MARKERS WHICH SUPPLEMENT WHITE PAVEMENT MARKINGS INSTALLED ON DIVIDED HIGHWAYS WITH MEDIAN WIDTHS FROM THIRTY (30) FEET (9 METERS) AND NOT HAVING A ROAD PHYSICAL MEDIAN BARRIER WHICH RESTRICTS VISIBILITY OF THE OPPOSING LANES SHALL BE REFLECTIVE IN ONE DIRECTION (MONO-DIRECTIONAL) ONLY. IN THESE CASES, THE FRONT FACE OF THE LENS SHALL BE WHITE. IF THE CHARACTERISTICS OF THE ROADWAY ARE SUCH THAT PORTIONS OF THE ROADWAY MEET THE CRITERIA ENCLOSED ABOVE FOR THE PLACEMENT OF BI-DIRECTIONAL REFLECTORS AND OTHER PORTIONS DO NOT, IT SHALL BE ACCEPTABLE TO INSTALL BI-DIRECTIONAL AND MONO-DIRECTIONAL REFLECTORS ALONG THEIR RESPECTIVE APPLICABLE PORTIONS OF THE ROADWAY. HOWEVER, IN SUCH CASES THE MINIMUM LENGTH OF EACH SECTION WITH BI-DIRECTIONAL REFLECTORS PLACED SHALL BE FIFTY (50) FEET (15.24 M) OTHERWISE, THE REFLECTORS PLACED ALONG SUCH SECTIONS SHALL BE MONO-DIRECTIONAL.
2. WHEN CALLED FOR IN THE PROJECT PLANS, ALL MARKERS INSTALLED TO SUPPLEMENT YELLOW EDGE LINE MARKERS SHALL BE REFLECTIVE IN ONE DIRECTION (MONO-DIRECTIONAL) ONLY. THE FRONT FACE OF THE LENS SHALL BE YELLOW.
3. ALL MARKERS INSTALLED TO SUPPLEMENT YELLOW CENTER LINE MARKINGS SHALL TYPICALLY BE REFLECTIVE IN BOTH DIRECTIONS (BI-DIRECTIONAL). BOTH LENS FACES SHALL BE YELLOW. NOTE THAT MARKER POSITIONING AND THE COMBINATION OF MONO-DIRECTIONAL AND BI-DIRECTIONAL YELLOW REFLECTORS TO SUPPLEMENT THE YELLOW MARKINGS OF A TWO BAY LEFT TURN LANE ARE A UNIQUE APPLICATION. THE CONTRACTOR IS ADVISED TO CLOSELY REVIEW THE REVISED DETAIL FOR GUIDANCE.

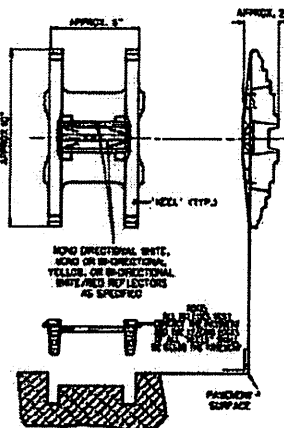

TYPICAL TYPE "P-2" MARKER
ITEM 84302-01

NOTE:
← THIS ARROW ONLY INDICATES DIRECTION OF TRAFFIC.

- LEGEND**
- BI-DIRECTIONAL (WHITE/RED) WITH WHITE REFLECTOR FACING TRAFFIC
 - MONO-DIRECTIONAL (WHITE)
 - ◆ BI-DIRECTIONAL (YELLOW)
 - ▷ MONO-DIRECTIONAL (YELLOW)

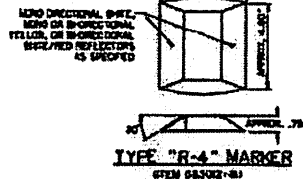

TYPICAL TYPE "R-4" MARKER
ITEM 84302-01

NOTES:
1. BI-DIRECTIONAL MARKERS SHOWN. MONO-DIRECTIONAL REFLECTORS MAY BE REQUIRED. (SEE DETAIL NOTES)

| MARKER TYPE | REFLECTOR TYPE | APPLICABLE TO | REMARKS |
|-------------|----------------|---------------|---------|
| P-2 | White | Day | |
| P-2 | White/Red | Night | |
| P-2 | Yellow | Day | |
| P-2 | Yellow | Night | |
| P-2 | White/Red | Day | |
| P-2 | White/Red | Night | |
| P-2 | Yellow | Day | |
| P-2 | Yellow | Night | |

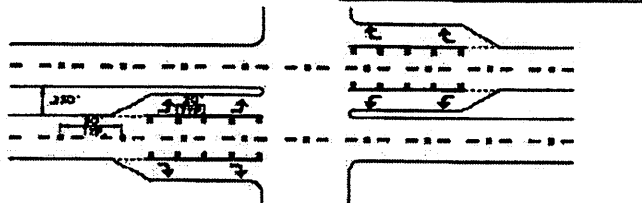

MULTI-LANE ROADWAY WITH AT-GRADE INTERSECTION

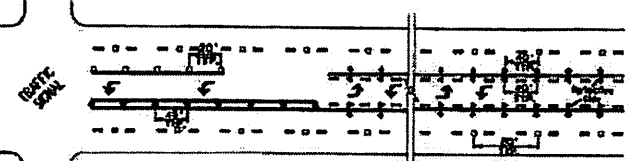

MULTI-LANE ROADWAY WITH TWO-BAY LEFT TURN LANE

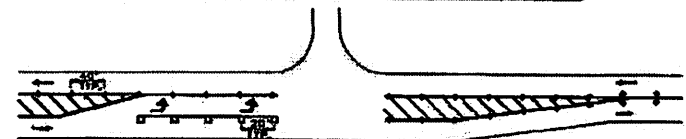

TWO LANE HIGHWAY WITH LEFT TURN BAY

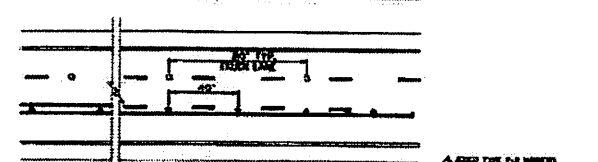

TWO LANE HIGHWAY WITH TRUCK CLIMBING LANE

- LEGEND:**
- ▲ GORE TYPE P-2 MARKER
 - △ RISED P-2 MARKER
 - ◆ RISED P-2, P-4, P-4, G-4 MARKER
 - ◇ RISED P-2, G-2, D-2
 - ▲ MARK ONLY

**WEST VIRGINIA DIVISION OF HIGHWAYS
REVISED STANDARD DETAIL
RAISED PAVEMENT MARKERS
TYPES "P" and "R"**

REQUIRED TYPICAL REGION

| MARKER TYPE | REFLECTOR TYPE | APPLICABLE TO | REMARKS |
|-------------|----------------|---------------|---------|
| P-2 | White | Day | |
| P-2 | White/Red | Night | |
| P-2 | Yellow | Day | |
| P-2 | Yellow | Night | |
| P-2 | White/Red | Day | |
| P-2 | White/Red | Night | |
| P-2 | Yellow | Day | |
| P-2 | Yellow | Night | |

STANDARD SHEET TEM-4

**WEST VIRGINIA DEPARTMENT OF TRANSPORTATION
DIVISION OF HIGHWAYS
DESIGN DIRECTIVE**

**DD-650
PAVEMENT SAFETY EDGE**
January 10, 2012

This Design Directive provides all designers with the West Virginia Department of Transportation (WVDOT), Division of Highways' (DOH) policy for providing a "safety edge" on all pavements meeting the required criteria.

10. General

Roadway Departure, in which a vehicle unintentionally departs its lane and either runs off the roadway, crosses the centerline or median, goes airborne, or hits a fixed object is the leading cause of fatalities on West Virginia roadways. Approximately 70% of all roadway fatalities are attributed to roadway departure in West Virginia.

Pavement edge drop-offs are a recurring problem between the pavement and the graded material that makes up the shoulder or roadside. Paved shoulders increase the chance of recovery but do not reduce the occurrence of drop offs from the shoulder to the roadside. Research has shown that even small drop-offs can create problems for drivers attempting to recover.

The Safety Edge is a simple, low cost technique that can make an edge drop-off significantly safer. The safety edge provides the driver with greater ease in returning the vehicle to the roadway, and reduction of the risk of over-steering and possible loss of control of the vehicle. With the safety edge in place, any interference in driving across any drop-off between the pavement edge and shoulder is mitigated by the slope of the safety edge, preventing tire “scrubbing” and thus providing errant drivers more opportunity to regain control of their vehicle and either avoid or lessen the severity of a crash.

20. Criteria for Use

The safety edge will be required on all NHS highway routes, and all routes designated “arterial” and “collector” in accordance with DD-601. It is to be used on both asphalt and concrete pavements unless the roadway or shoulder is curbed or is bounded by a barrier such as a single-slope barrier (usually in the median of 6-lane (or more) expressways and Interstate highways, but can be at the edge of the shoulder in certain applications). The Safety Edge is recommended for all other designated roadways in accordance with DD-601.

On overlay projects, Safety Edge is recommended if the total overlay thickness (scratch excluded) is 1.5” or greater. Safety Edge will not be placed if total overlay thickness is less than 1.5”. In addition, if overlay project involves milling and replacing in kind on mainline only (commonly referred to as “mill and fill” projects), then Safety Edge will not be utilized.

30. Design and Plan Requirements

The angle of the bevel from the slope of the pavement is critical for the safety edge to function properly. Measured from the cross slope of the pavement, the required angle ranges from 30 to 35 degrees.

For pavements with safety edge, shoulder aggregate shall be placed and maintained to the top of the pavement elevation.

In areas where the shoulder is soft and cannot be compacted, or for other reasons it cannot provide support for the safety edge, widening of the pavement shall be provided to support the edge. Field investigations should be made to check for any condition that will not support the safety edge. However if this condition exists at locations where the shoulder is non-existent and the edge of pavement is at the top of a roadside ditchline, the outside point of the safety edge (the toe) should be placed at the original edge of pavement, with the edge stripe at the safety edge's breakpoint. The designer must use sound engineering judgment when resurfacing existing roadways regarding the location of the new edge of pavement, placement of the safety edge, and any pavement widening.

When safety edge is required, it will be detailed on the typical sections. If there are any areas where the edge is not required or cannot be placed, limiting stations will also be given.

The following sketches are not to scale and represent a schematic detail for the purpose of showing configurations and dimensions only. Also, the free-draining base course trench may not be located as shown in these sketches.

A. Asphalt Pavement and Overlays

For projects bid in Tons (Megagrams) the asphalt quantity will be the actual quantity computed, including the safety edge. Note that the safety edge can be constructed on each lift of asphalt.

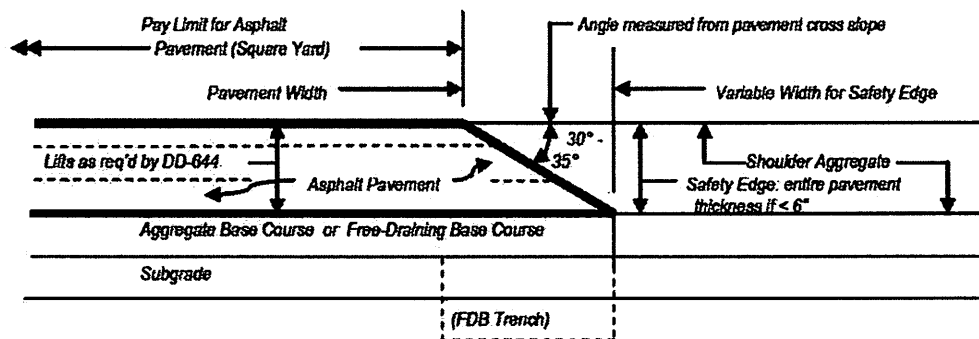

Safety Edge Dimensions for Asphalt Pavement (New Construction < 6" thickness)

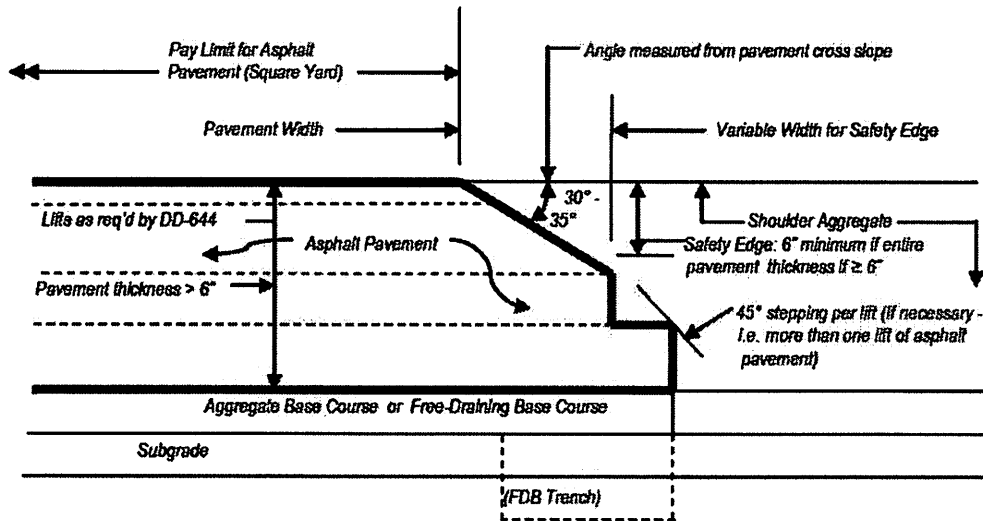

Safety Edge Dimensions for Asphalt Pavement (New Construction ≥ 6 \" thickness)

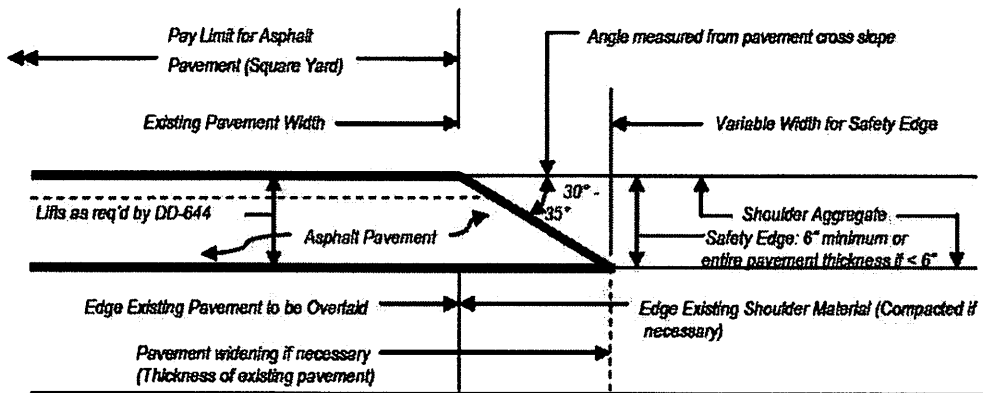

Safety Edge Dimensions for Asphalt Pavement (Overlay – for Roadways with Established Design Criteria, i.e. Interstate, APD, NHS and US Routes)

B. Concrete Pavement and Overlays

The sloped portion of the safety edge is to be 6\" minimum in vertical height. To allow proper finishing by a slip-form paver, a minimum 2\" vertical face is required at the bottom outside of the safety edge.

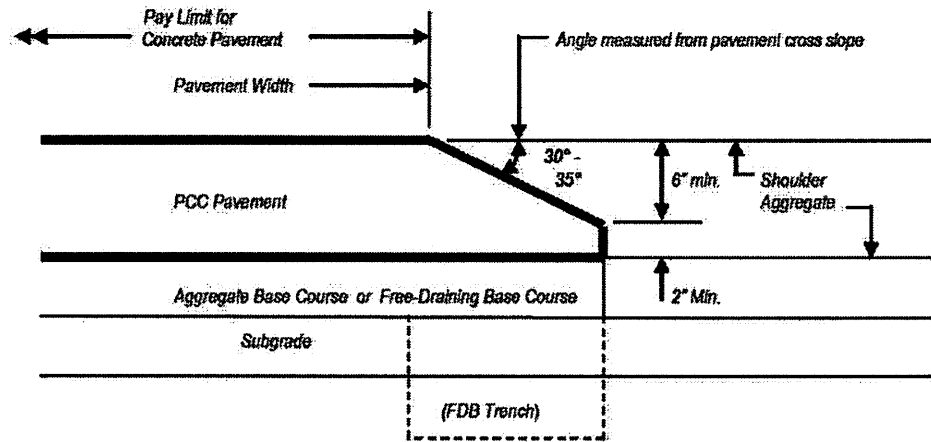

Safety Edge Dimensions for Concrete Pavement (New Construction)

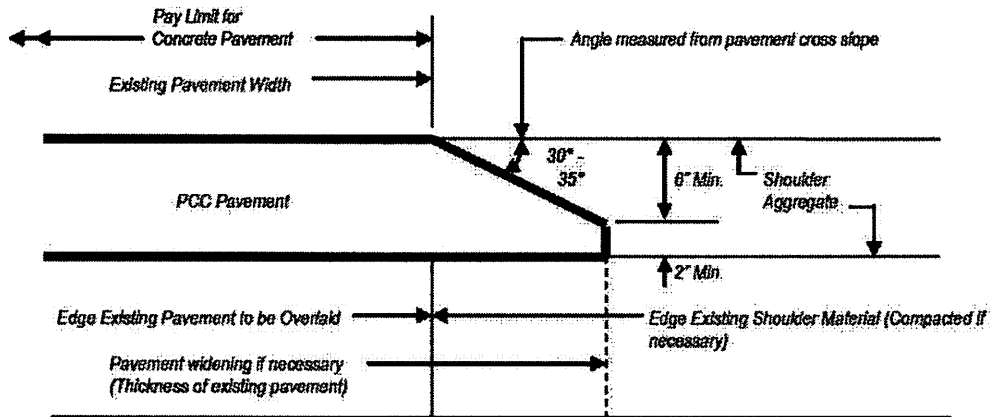

Safety Edge Dimensions for Concrete Pavement Overlay – for Roadways with Established Design Criteria, I.e. Interstate, APD, NHS and US Routes)

WEST VIRGINIA DEPARTMENT OF TRANSPORTATION

DIVISION OF HIGHWAYS

SPECIAL PROVISION

FOR

STATE PROJECT NUMBER: _____

FEDERAL PROJECT NUMBER: _____

SECTION 401

ASPHALT BASE, WEARING, AND PATCHING AND LEVELING COURSES

ADD THE FOLLOWING SUBSECTION TO THE SECTION:

401.4.3-Increase of Reclaimed Asphalt Pavement (RAP) in Asphalt Concrete Mixes: This Special Provision has been written to address the use of increased amounts of reclaimed asphalt pavement (RAP) used within mixes produced for projects in the WVDOH construction program.

The increased use of RAP can become an effective measure to help reduce overall construction costs and ultimately allow the WVDOH to treat more mileage within the established annual budgets. This will also allow the WVDOH to accomplish savings while at the same time, doing so in an environmentally responsible manner. However, it is important that any steps taken to use increased amounts of RAP be performed in a manner that will also not be detrimental to the quality of the asphalt concrete mixes produced.

The WVDOH will allow the increased use of RAP in Marshall Base 1 and Base 2, and Superpave 19 mm, 25 mm, and 37.5 mm mixes up to 25%. Initially, all mix designs shall be submitted in accordance to MP 401.02.24, with the exception that Section 5.0, Line 5.4 pertaining to RAP contents between 16% and 25% will be waived. The addition of up to 25% RAP will be allowed in Marshall Base 1, and Superpave 25 mm and 37.5 mm mixes for all applications provided that the processing of RAP is consistent with that discussed for State Funded projects below. For Marshall Base 2 and SP 19 mm, the following criteria shall be used for acceptance during production:

401.4.3.1-Interstates, APD Corridors, and Multilane Roadways:

- a) **Superpave 401 projects with PWL factors:** 25% RAP Base 2 or SP 19mm will be allowed.
- b) **All other projects will require one random loose roadway sample per 1000 ton placed.** Samples will be taken generally as per MP 401.07.21, by the Contractor along with WVDOH personnel. Each sample then will be tested by the Contractor in order to determine AC and gradation, and all such testing shall be witnessed by the WVDOH. The contractor must have an established ignition oven correction factor for both AC Content and gradation for each mixture. In addition this correction factor must be established prior to the project and will only be valid during the paving season it was established. All

sample results for AC and Gradation shall then be evaluated for additional pay factors as per Table 401.13.3.1 of the SP 401 Square Yard PWL, then applied in the formula shown below. The results for AC and gradation (minus #200) from QC samples at the plant will not be used for determination of pay adjustment. A lot will be 5,000 tons or portion thereof with a minimum of three samples. Portions less than 2,000 tons shall be incorporated into the previous lot. There will be no incentive for PWL from 96 to 100.

$$\text{Pay Deduction per Ton or SY (\%)} = \frac{100 - [(PF_{AC} + PF_G) / 2]}{2}$$

401.4.3.2-Other Federal Aid and NHS routes:

- a) WVDOH will monitor plant QC Samples for AC and gradation for the mix being produced. The contractor must have an established ignition oven correction factor for both AC Content and gradation for each mixture. In addition this correction factor must be established prior to the project and will only be valid during the paving season it was established. These results shall then be evaluated for additional pay factors as per Table 401.13.3.1 of SP 401 Square Yard PWL, and then applied in the formula shown below. A lot will be five samples or portion thereof with a minimum of three samples. Testing frequency shall be a minimum of 1 sample per 1,000 tons of daily production (maximum of 750 tons for adjusted sublots) and shall include gradation and AC content for each sample. There shall be at least one sample per day of production. Lots may cover more than one project, but no more than three. Any penalties calculated shall be applied to all the material represented by the testing of the evaluated lot. Portions less than two samples shall be incorporated into the previous lot. There will be no incentive for PWL from 96 to 100.

$$\text{Pay Deduction per Ton or SY (\%)} = \frac{100 - [(PF_{AC} + PF_G) / 2]}{2}$$

401.4.3.3-State Funded Projects (including Marshall Wearing IV or Superpave 19mm may be used as surface mix on routes with ADT below 3000):

- a) Process for addition of RAP shall include initial scalping to remove + 3/4" (19 mm) material and proper stockpile management in accordance with Best Practices for RAP Management as documented by NCHRP report 752, Appendix D, and as discussed in Publication No. FHWA-HRT-11-0-21. These documents can be accessed at the respective links below:

http://onlinepubs.trb.org/onlinepubs/nchrp/nchrp_rpt_752.pdf

<http://www.fhwa.dot.gov/publications/research/infrastructure/pavements/11021/11021.pdf>

The submission of mix designs shall be done in the same manner as described for Marshall Base 2/Superpave 19 mm above and production shall be monitored as described above for other Federal Aid or NHS Routes.

Vendor Name: J&M Paving & Sealing

Vendor Instructions: Vendor shall complete ATT B by entering a bid price for the Contract Items below, to correspond with the Contract items on ATT A. Vendor must complete TWO (2) Pricing Pages (ATT A and ATT B) as well as TWO (2) Plant Information Forms (ATT C and ATT D) with bid. **Bids submissions that do not include ATT A, ATT B, ATT C and ATT D WILL BE DISQUALIFIED.**

| | County | Unit of Measure | <u>Item 19,</u> Mobilization Shoulder Stone | <u>Item 33,</u> Mobilization DAYTIME Paving | <u>Item 34,</u> Mobilization NIGHTTIME Paving | <u>Item 62,</u> Mobilization Pavement Profiling | <u>Item 83,</u> Mobilization Milled Rumble Strips | <u>Item 94</u> <u>Mobilization</u> <u>RPM</u> <u>Installation</u> | <u>Item 96</u> Mobilization RPM Removal | <u>Item 102</u> Mobilization VRAM |
|-------------|----------|-----------------|--|--|--|--|--|--|--|---|
| District 10 | McDowell | LUMP SUM | No Bid | \$ 2,500.00 | \$ 15,000.00 | \$ 4,500.00 | \$ 4,900.00 | No Bid | No Bid | No Bid |
| | Mercer | LUMP SUM | No Bid | \$ 2,500.00 | \$ 15,000.00 | \$ 4,500.00 | \$ 4,900.00 | No Bid | No Bid | No Bid |
| | Raleigh | LUMP SUM | No Bid | \$ 2,500.00 | \$ 15,000.00 | \$ 4,500.00 | \$ 4,900.00 | No Bid | No Bid | No Bid |
| | Wyoming | LUMP SUM | No Bid | \$ 2,500.00 | \$ 15,000.00 | \$ 4,500.00 | \$ 4,900.00 | No Bid | No Bid | No Bid |

Asphalt Materials Delivery Labor by Vendor ATTACHMENT C - ASPHALT PLANT INFORMATION FORM (ATT C)

Vendor Instructions: Vendor shall enter below the source ASPHALT plant names and locations asphalt may be pulled from under this contract, and which are listed on Attachment A, including their 911 address. Vendor must list with each sourced plant name and location listed the counties that plant will be used to service for this contract. Reference Section 6.3 for additional information. If additional space is needed to list additional plant locations, Vendor shall submit multiple ATT C pages to ensure all plants are accounted for under this contract. **Bids submissions that do not include ATT A, ATT B, ATT C and ATT D WILL BE DISQUALIFIED.**

Vendor Name: J&M Paving & Sealing

| Vendor's ASPHALT Plant Location for use with LAYDOWN services: | | | | | | | | | |
|--|---------------------------------------|------------------------------------|-------------------------------------|------------------------------------|-----------------------------------|----------------------------------|-------------------------------------|-------------------------------------|--|
| Plant Name: | Southern West Virginia Asphalt | | | | | | | | |
| Plant Location: | 6941 Ingleside Dr, Princeton WV 24740 | | | | | | | | |
| Latitude & Longitude Coordinates: | 37.31492 -81.05545 | | | | | | | | |
| This plant may service the following counties under this contract: | | | | | | | | | |
| <i>District 1</i> | <i>District 2</i> | <i>District 3</i> | <i>District 4</i> | <i>District 5</i> | <i>District 6</i> | <i>District 7</i> | <i>District 8</i> | <i>District 9</i> | <i>District 10</i> |
| <input type="checkbox"/> Boone | <input type="checkbox"/> Cabell | <input type="checkbox"/> Calhoun | <input type="checkbox"/> Doddridge | <input type="checkbox"/> Berkeley | <input type="checkbox"/> Brooke | <input type="checkbox"/> Barbour | <input type="checkbox"/> Pendleton | <input type="checkbox"/> Fayette | <input checked="" type="checkbox"/> McDowell |
| <input type="checkbox"/> Clay | <input type="checkbox"/> Lincoln | <input type="checkbox"/> Jackson | <input type="checkbox"/> Harrison | <input type="checkbox"/> Grant | <input type="checkbox"/> Hancock | <input type="checkbox"/> Braxton | <input type="checkbox"/> Pocahontas | <input type="checkbox"/> Greenbrier | <input checked="" type="checkbox"/> Mercer |
| <input type="checkbox"/> Kanawha | <input type="checkbox"/> Logan | <input type="checkbox"/> Pleasants | <input type="checkbox"/> Marion | <input type="checkbox"/> Hampshire | <input type="checkbox"/> Marshall | <input type="checkbox"/> Gilmer | <input type="checkbox"/> Randolph | <input type="checkbox"/> Monroe | <input checked="" type="checkbox"/> Raleigh |
| <input type="checkbox"/> Mason | <input type="checkbox"/> Mingo | <input type="checkbox"/> Ritchie | <input type="checkbox"/> Monongalia | <input type="checkbox"/> Hardy | <input type="checkbox"/> Ohio | <input type="checkbox"/> Lewis | <input type="checkbox"/> Tucker | <input type="checkbox"/> Nicholas | <input checked="" type="checkbox"/> Wyoming |
| <input type="checkbox"/> Putnam | <input type="checkbox"/> Wayne | <input type="checkbox"/> Roane | <input type="checkbox"/> Preston | <input type="checkbox"/> Jefferson | <input type="checkbox"/> Tyler | <input type="checkbox"/> Upshur | | <input type="checkbox"/> Summers | |
| | | <input type="checkbox"/> Wirt | <input type="checkbox"/> Taylor | <input type="checkbox"/> Mineral | <input type="checkbox"/> Wetzel | <input type="checkbox"/> Webster | | | |
| | | <input type="checkbox"/> Wood | | <input type="checkbox"/> Morgan | | | | | |

Asphalt Materials Delivery Labor by Vendor ATTACHMENT A PRICING PAGE (ATT A)

Vendor Name: J&M PAVING & SEALING

Vendor's Sourced Asphalt Plant(s): SOUTHERN WEST VIRGINIA ASPHALT
6941 INGLESIDE DRIVE
PRINCETON WV 24740

Vendor Instructions: Vendor shall mark with an "X" the counties that correspond with the Asphalt Plant(s) bid prices on this page. If Vendor has varied pricing per county, Vendor shall complete a separate set of Pricing Pages (ATT A and ATT B if different) for each county pricing set. Vendor must complete TWO (2) Pricing Pages (ATT A and ATT B) as well as TWO (2) Plant Information Forms (ATT C and ATT D) with bid. **Bids submissions that do not include ATT A, ATT B, ATT C and ATT D WILL BE DISQUALIFIED.**

This is a multiple vendor award contract. All qualifying vendor meeting the contract specifications will be awarded with a contract. The low bid vendor per project will be determined at the time of need, as per Section 6.1 of the Contract Specifications. Estimated quantities are not available.

| | | | | | | | | | |
|----------------------------------|----------------------------------|------------------------------------|-------------------------------------|------------------------------------|-----------------------------------|----------------------------------|-------------------------------------|-------------------------------------|--|
| <input type="checkbox"/> Boone | <input type="checkbox"/> Cabell | <input type="checkbox"/> Calhoun | <input type="checkbox"/> Doddridge | <input type="checkbox"/> Berkeley | <input type="checkbox"/> Brooke | <input type="checkbox"/> Barbour | <input type="checkbox"/> Pendleton | <input type="checkbox"/> Fayette | <input checked="" type="checkbox"/> McDowell |
| <input type="checkbox"/> Clay | <input type="checkbox"/> Lincoln | <input type="checkbox"/> Jackson | <input type="checkbox"/> Harrison | <input type="checkbox"/> Grant | <input type="checkbox"/> Hancock | <input type="checkbox"/> Braxton | <input type="checkbox"/> Pocahontas | <input type="checkbox"/> Greenbrier | <input checked="" type="checkbox"/> Mercer |
| <input type="checkbox"/> Kanawha | <input type="checkbox"/> Logan | <input type="checkbox"/> Pleasants | <input type="checkbox"/> Marion | <input type="checkbox"/> Hampshire | <input type="checkbox"/> Marshall | <input type="checkbox"/> Gilmer | <input type="checkbox"/> Randolph | <input type="checkbox"/> Monroe | <input checked="" type="checkbox"/> Raleigh |
| <input type="checkbox"/> Mason | <input type="checkbox"/> Mingo | <input type="checkbox"/> Ritchie | <input type="checkbox"/> Monongalia | <input type="checkbox"/> Hardy | <input type="checkbox"/> Ohio | <input type="checkbox"/> Lewis | <input type="checkbox"/> Tucker | <input type="checkbox"/> Nicholas | <input checked="" type="checkbox"/> Wyoming |
| <input type="checkbox"/> Putnam | <input type="checkbox"/> Wayne | <input type="checkbox"/> Roane | <input type="checkbox"/> Preston | <input type="checkbox"/> Jefferson | <input type="checkbox"/> Tyler | <input type="checkbox"/> Upshur | | <input type="checkbox"/> Summers | |
| | | <input type="checkbox"/> Wirt | <input type="checkbox"/> Taylor | <input type="checkbox"/> Mineral | <input type="checkbox"/> Wetzel | <input type="checkbox"/> Webster | | | |
| | | <input type="checkbox"/> Wood | | <input type="checkbox"/> Morgan | | | | | |

| Contract Item # | Contract Item Description | Unit of Measure | List Price |
|-----------------|--|-----------------|------------|
| 1 | Asphalt Section 401 - Base I | TON | \$145.00 |
| 2 | Asphalt Section 401 - 25mm Superpave | TON | No Bid |
| 3 | Asphalt Section 401 - Base II | TON | \$145.00 |
| 4 | Asphalt Section 401 - Patch and Level | TON | \$155.00 |
| 5 | Asphalt Section 401 - Wearing IV | TON | No Bid |
| 6 | Asphalt Section 402 - Wearing IV | TON | No Bid |
| 7 | Asphalt Section 401 - 19mm Superpave | TON | No Bid |
| 8 | Asphalt Section 401 - Scratch Course | TON | \$155.00 |
| 9 | Asphalt Section 402 - 9.5mm Superpave | TON | No Bid |
| 10 | Asphalt Section 401 - Wearing 1 | TON | \$155.00 |
| 11 | Asphalt Section 402 - Wearing 1 | TON | \$165.00 |
| 12 | Asphalt Section 401 - 4.75mm Superpave | TON | No Bid |
| 13 | Asphalt Section 402 - 4.75mm Superpave | TON | No Bid |
| 14 | Asphalt Section 401 - Wearing III | TON | No Bid |
| 15 | Asphalt Section 402 - Wearing III | TON | No Bid |
| 16 | Asphalt Section 401 - 12.5mm Superpave | TON | No Bid |
| 17 | Asphalt Section 402 - 12.5mm Superpave | TON | No Bid |
| 18 | Shoulder Stone Placement for Asphalt Section 307 - Class 10 | TON | No Bid |
| 19 | Shoulder Stone Mobilization - Complete on ATT B | LUMP SUM | ----- |
| 20 | Haul by Vendor Shoulder Stone Placement - First Ton Mile | TON MILE | No Bid |
| 21 | Haul by Vendor Shoulder Stone Placement - Each Additional Ton Mile | TON MILE | No Bid |
| 22 | Surcharge for PG Binder 58-28S | TON | No Bid |
| 23 | Surcharge for PG Binder 64H minus 22 | TON | No Bid |
| 24 | Surcharge for PG Binder 64E minus 22 ordered in 400 Ton increments | TON | No Bid |
| 25 | ESAL Surcharge - 3 million to 20 million ESALS | TON | No Bid |
| 26 | ESAL Surcharge - Greater than 20 million ESALS | TON | No Bid |
| 27 | Asphalt Haul by Vendor - First Ton Mile | TON MILE | \$5.95 |
| 28 | Asphalt Haul by Vendor - Each Additional Ton Mile | TON MILE | \$2.95 |
| 29 | Laydown of Material Items #1-17, Each Site 0-100 Tons | TON | \$95.00 |
| 30 | Laydown of Material Items #1-17, Each Site 101 to 200 Tons | TON | \$85.00 |
| 31 | Laydown of Material Items #1-17, Each Site 201 to 500 Tons | TON | \$75.00 |
| 32 | Laydown of Material Items #1-17, Each Site 501 Tons or Greater | TON | \$70.00 |
| 33 | Daytime Paving Mobilization - Complete on ATT B | LUMP SUM | ----- |
| 34 | Nighttime Paving Mobilization - Complete on ATT B | LUMP SUM | ----- |
| 35 | Excavation for Shoulder Paving - 0 to 1000 Sq. Yards | SY | No Bid |
| 36 | Excavation for Shoulder Paving - 1001 to 2000 Sq. Yards | SY | No Bid |
| 37 | Excavation for Shoulder Paving - 2001 to 3000 Sq. Yards | SY | No Bid |
| 38 | Excavation for Shoulder Paving - 3001 Sq. Yards or Greater | SY | No Bid |
| 39 | Asphalt Base I Shoulder Paving Surcharge - 0 to 100 Tons | TON | No Bid |
| 40 | Asphalt Base I Shoulder Paving Surcharge - 101 to 200 Tons | TON | No Bid |
| 41 | Asphalt Base I Shoulder Paving Surcharge - 201 to 500 Tons | TON | No Bid |
| 42 | Asphalt Base I Shoulder Paving Surcharge - 501 Tons or Greater | TON | No Bid |
| 43 | Asphalt Base II Shoulder Paving Surcharge - 0 to 100 Tons | TON | No Bid |

Asphalt Materials Delivery Labor by Vendor ATTACHMENT A PRICING PAGE (ATT A)

| | | | |
|-----|--|-------------|------------|
| 44 | Asphalt Base II Shoulder Paving Surcharge - 101 to 200 Tons | TON | No Bid |
| 45 | Asphalt Base II Shoulder Paving Surcharge - 201 to 500 Tons | TON | No Bid |
| 46 | Asphalt Base II Shoulder Paving Surcharge - 501 Tons or Greater | TON | No Bid |
| 47 | Asphalt Material for Tack Coat | GAL | \$4.95 |
| 48 | Additional Heel-In Joints | LF | \$13.00 |
| 49 | Skip Paving Surcharge | TON | \$10.00 |
| 50 | Pavement Profiling/Milling-WVDOH Owns Millings 0 to 250 Sq. Yards | SY | \$25.00 |
| 51 | Pavement Profiling/Milling-WVDOH Owns Millings 251 to 500 Sq. Yards | SY | \$20.00 |
| 52 | Pavement Profiling/Milling-WVDOH Owns Millings 501 to 1000 Sq. Yards | SY | \$15.00 |
| 53 | Pavement Profiling/Milling-WVDOH Owns Millings 1001 to 2500 Sq. Yards | SY | \$12.00 |
| 54 | Pavement Profiling/Milling-WVDOH Owns Millings 2501 to 5000 Sq. Yards | SY | \$10.00 |
| 55 | Pavement Profiling/Milling-WVDOH Owns Millings 5001 Sq. Yards or Greater | SY | \$8.00 |
| 56 | Pavement Profiling/Milling-Vendor Owns Millings 0 to 250 Sq. Yards | SY | \$25.00 |
| 57 | Pavement Profiling/Milling-Vendor Owns Millings 251 to 500 Sq. Yards | SY | \$20.00 |
| 58 | Pavement Profiling/Milling-Vendor Owns Millings 501 to 1000 Sq. Yards | SY | \$15.00 |
| 59 | Pavement Profiling/Milling-Vendor Owns Millings 1001 to 2500 Sq. Yards | SY | \$12.00 |
| 60 | Pavement Profiling/Milling-Vendor Owns Millings 2501 to 5000 Sq. Yards | SY | \$10.00 |
| 61 | Pavement Profiling/Milling-Vendor Owns Millings 5001 Sq. Yards or Greater | SY | \$8.00 |
| 62 | Pavement Profiling/Milling Mobilization - Complete on ATT B | LUMP SUM | ----- |
| 63 | Haul of Profiled/Milled Cuttings or Fine Millings, First 10 Miles (Included with #50-61 and #70-81) | MILE | ----- |
| 64 | Haul of Profiled/Milled Cuttings or Fine Millings (each additional Ton Mile after 10 miles) | TON MILE | \$2.95 |
| 65 | Pavement Repair-Asphalt Base II | SY | \$600.00 |
| 66 | Asphalt HPTO - SP496 - PG 64E-22 (400 Ton increments) | TON | No Bid |
| 67 | Non-Tracking Tack | GAL | No Bid |
| 68 | Lay Down of Materials - to be used with #66 - 400 Ton or Greater | TON | No Bid |
| 69 | Ultra-Thin Asphalt Overlay - SP498 | TON | No Bid |
| 70 | Fine Milling -WVDOH Owns Millings 0 to 250 Sq. Yards | SY | No Bid |
| 71 | Fine Milling -WVDOH Owns Millings 251 to 500 Sq. Yards | SY | No Bid |
| 72 | Fine Milling -WVDOH Owns Millings 501 to 1000 Sq. Yards | SY | No Bid |
| 73 | Fine Milling -WVDOH Owns Millings 1001 to 2500 Sq. Yards | SY | No Bid |
| 74 | Fine Milling -WVDOH Owns Millings 2501 to 5000 Sq. Yards | SY | No Bid |
| 75 | Fine Milling -WVDOH Owns Millings 5001 SY or Greater | SY | No Bid |
| 76 | Fine Milling- Vendor Owns Millings 0 to 250 Sq. Yards | SY | No Bid |
| 77 | Fine Milling- Vendor Owns Millings 251 to 500 Sq. Yards | SY | No Bid |
| 78 | Fine Milling- Vendor Owns Millings 501 to 1000 Sq. Yards | SY | No Bid |
| 79 | Fine Milling- Vendor Owns Millings 1001 to 2500 Sq. Yards | SY | No Bid |
| 80 | Fine Milling- Vendor Owns Millings 2501 to 5000 Sq. Yards | SY | No Bid |
| 81 | Fine Milling- Vendor Owns Millings 5001 SY or Greater | SY | No Bid |
| 82 | Milled Rumble Strips | LF | \$0.75 |
| 83 | Milled Rumble Strip Mobilization - Complete on ATT B | LUMP SUM | ----- |
| 84 | Parking Lot and Facility Paving Surcharge - Items #1-17, #66, and #69 | TON | \$9.50 |
| 85 | Cleaning and Sweeping | SY | \$1.00 |
| 86 | Traffic Maintenance: Pilot Truck and Driver | DAY | \$1,200.00 |
| 87 | Traffic Maintenance: Traffic Control Devices | UNIT | \$2.00 |
| 88 | Traffic Maintenance: Flagger | HOUR | \$95.00 |
| 89 | Traffic Maintenance: Arrow Board | DAY | \$80.00 |
| 90 | Off-Season Plant Opening - First Day | DAY | No Bid |
| 91 | Off-Season Plant Opening - Each Additional Day | DAY | No Bid |
| 92 | Raised Pavement Marker (RPM), Type P-2 with Installation | EACH | No Bid |
| 93 | Raised Pavement Marker (RPM), Type R-4 with Installation | EACH | No Bid |
| 94 | RPM Installation Mobilization - Complete on ATT B | LUMP SUM | ----- |
| 95 | Raised Pavement Marker (RPM) Removal | EACH | No Bid |
| 96 | RPM Removal Mobilization - Complete on ATT B | LUMP SUM | ----- |
| 97 | VRAM (Void Reducing Asphalt Membrane) 0-1000 LF | LINEAR FOOT | No Bid |
| 98 | VRAM (Void Reducing Asphalt Membrane) 1001-2000 LF | LINEAR FOOT | No Bid |
| 99 | VRAM (Void Reducing Asphalt Membrane) 2001-5,000 LF | LINEAR FOOT | No Bid |
| 100 | VRAM (Void Reducing Asphalt Membrane) 5,001 LF or greater | LINEAR FOOT | No Bid |
| 101 | VRAM Preparation - Removal of Center Line | LINEAR FOOT | No Bid |
| 102 | VRAM Mobilization - Complete on ATT B | LUMP SUM | ----- |

STATE OF WEST VIRGINIA
Purchasing Division

PURCHASING AFFIDAVIT

CONSTRUCTION CONTRACTS: Under W. Va. Code § 5-22-1(i), the contracting public entity shall not award a construction contract to any bidder that is known to be in default on any monetary obligation owed to the state or a political subdivision of the state, including, but not limited to, obligations related to payroll taxes, property taxes, sales and use taxes, fire service fees, or other fines or fees.

ALL CONTRACTS: Under W. Va. Code §5A-3-10a, no contract or renewal of any contract may be awarded by the state or any of its political subdivisions to any vendor or prospective vendor when the vendor or prospective vendor or a related party to the vendor or prospective vendor is a debtor and: (1) the debt owed is an amount greater than one thousand dollars in the aggregate; or (2) the debtor is in employer default.

EXCEPTION: The prohibition listed above does not apply where a vendor has contested any tax administered pursuant to chapter eleven of the W. Va. Code, workers' compensation premium, permit fee or environmental fee or assessment and the matter has not become final or where the vendor has entered into a payment plan or agreement and the vendor is not in default of any of the provisions of such plan or agreement.

DEFINITIONS:

"Debt" means any assessment, premium, penalty, fine, tax or other amount of money owed to the state or any of its political subdivisions because of a judgment, fine, permit violation, license assessment, defaulted workers' compensation premium, penalty or other assessment presently delinquent or due and required to be paid to the state or any of its political subdivisions, including any interest or additional penalties accrued thereon.

"Employer default" means having an outstanding balance or liability to the old fund or to the uninsured employers' fund or being in policy default, as defined in W. Va. Code § 23-2c-2, failure to maintain mandatory workers' compensation coverage, or failure to fully meet its obligations as a workers' compensation self-insured employer. An employer is not in employer default if it has entered into a repayment agreement with the Insurance Commissioner and remains in compliance with the obligations under the repayment agreement.

"Related party" means a party, whether an individual, corporation, partnership, association, limited liability company or any other form or business association or other entity whatsoever, related to any vendor by blood, marriage, ownership or contract through which the party has a relationship of ownership or other interest with the vendor so that the party will actually or by effect receive or control a portion of the benefit, profit or other consideration from performance of a vendor contract with the party receiving an amount that meets or exceeds five percent of the total contract amount.

AFFIRMATION: By signing this form, the vendor's authorized signer affirms and acknowledges under penalty of law for false swearing (W. Va. Code §61-5-3) that: (1) for construction contracts, the vendor is not in default on any monetary obligation owed to the state or a political subdivision of the state, and (2) for all other contracts, that neither vendor nor any related party owe a debt as defined above and that neither vendor nor any related party are in employer default as defined above, unless the debt or employer default is permitted under the exception above.

WITNESS THE FOLLOWING SIGNATURE:

Vendor's Name: J&M Heating and Air Conditioning, Inc Db a J&M Paving & Sealing

Authorized Signature: *[Signature]* Date: 09/17/2024

State of West Virginia

County of Mercer, to-wit:

Taken, subscribed, and sworn to before me this 17 day of Sept., 2024

My Commission expires 10-31-26, 20 .

AFFIX SEAL HERE

NOTARY PUBLIC

