



Department of Administration
 Purchasing Division
 2019 Washington Street East
 Post Office Box 50130
 Charleston, WV 25305-0130

**State of West Virginia
 Solicitation Response**

Proc Folder: 1593441
Solicitation Description: Ditch, Pipe and Asphalt Repair and Maintenance by the Vendor
Proc Type: Agency Master Agreement

Solicitation Closes	Solicitation Response	Version
2025-01-23 10:30	SR 0803 ESR01222500000004457	1

VENDOR
 000000160630
 CAST & BAKER CORP

Solicitation Number: ARFQ 0803 DOT2500000026
Total Bid: 0
Response Date: 2025-01-22
Response Time: 15:43:51
Comments:

FOR INFORMATION CONTACT THE BUYER
 Jeromie F Lanham
 304-720-7383
 jeromie.f.lanham@wv.gov

Vendor Signature X **FEIN#** **DATE**

All offers subject to all terms and conditions contained in this solicitation

Line	Comm Ln Desc	Qty	Unit Issue	Unit Price	Ln Total Or Contract Amount
1	Pilot Truck and Driver	0.00000	DAY	1000.000000	0.00

Comm Code	Manufacturer	Specification	Model #
46161500			

Commodity Line Comments:

Extended Description:

See Attached Pricing Page- Attachment A, For Actual Cost.

Line	Comm Ln Desc	Qty	Unit Issue	Unit Price	Ln Total Or Contract Amount
2	Traffic Control Devices	0.00000	UNIT	5.250000	0.00

Comm Code	Manufacturer	Specification	Model #
46161500			

Commodity Line Comments:

Extended Description:

See Attached Pricing Page- Attachment A, For Actual Cost.

Line	Comm Ln Desc	Qty	Unit Issue	Unit Price	Ln Total Or Contract Amount
3	Traffic Flagger	0.00000	HOUR	150.000000	0.00

Comm Code	Manufacturer	Specification	Model #
46161500			

Commodity Line Comments:

Extended Description:

See Attached Pricing Page- Attachment A, For Actual Cost.

Line	Comm Ln Desc	Qty	Unit Issue	Unit Price	Ln Total Or Contract Amount
4	Arrow Board	0.00000	DAY	95.000000	0.00

Comm Code	Manufacturer	Specification	Model #
46161500			

Commodity Line Comments:

Extended Description:

See Attached Pricing Page- Attachment A, For Actual Cost.

Line	Comm Ln Desc	Qty	Unit Issue	Unit Price	Ln Total Or Contract Amount
5	Ditching (Shoulder Mile)	0.00000	MILE	20000.000000	0.00

Comm Code	Manufacturer	Specification	Model #
72141003			

Commodity Line Comments:

Extended Description:

See Attached Pricing Page- Attachment A, For Actual Cost.

Line	Comm Ln Desc	Qty	Unit Issue	Unit Price	Ln Total Or Contract Amount
6	Correcting Deep Ditches	0.00000	TON	380.000000	0.00

Comm Code	Manufacturer	Specification	Model #
72141003			

Commodity Line Comments:

Extended Description:

See Attached Pricing Page- Attachment A, For Actual Cost.

Line	Comm Ln Desc	Qty	Unit Issue	Unit Price	Ln Total Or Contract Amount
7	Restoring Shoulders and Shoulder Stone	0.00000	TON	460.000000	0.00

Comm Code	Manufacturer	Specification	Model #
72141003			

Commodity Line Comments:

Extended Description:

See Attached Pricing Page- Attachment A, For Actual Cost.

Line	Comm Ln Desc	Qty	Unit Issue	Unit Price	Ln Total Or Contract Amount
8	Shoulder Stone Placement	0.00000	TON	300.000000	0.00

Comm Code	Manufacturer	Specification	Model #
72141003			

Commodity Line Comments:

Extended Description:

See Attached Pricing Page- Attachment A, For Actual Cost.

Line	Comm Ln Desc	Qty	Unit Issue	Unit Price	Ln Total Or Contract Amount
9	Ditching Haul by Vendor for Items 6, 7 & 8 (Ton Mile)	0.00000	MILE	7.500000	0.00

Comm Code	Manufacturer	Specification	Model #
72141003			

Commodity Line Comments:

Extended Description:

See Attached Pricing Page- Attachment A, For Actual Cost.

Line	Comm Ln Desc	Qty	Unit Issue	Unit Price	Ln Total Or Contract Amount
10	Ditching Haul for Items 6, 7 & 8 Add'l Mile (Ton Mile)	0.00000	MILE	0.750000	0.00

Comm Code	Manufacturer	Specification	Model #
72141003			

Commodity Line Comments:

Extended Description:

See Attached Pricing Page- Attachment A, For Actual Cost.

Line	Comm Ln Desc	Qty	Unit Issue	Unit Price	Ln Total Or Contract Amount
11	Ditching Waste Haul by Vendor per Truck/ Driver	0.00000	HOUR	150.000000	0.00

Comm Code	Manufacturer	Specification	Model #
72153507			

Commodity Line Comments:

Extended Description:

See Attached Pricing Page- Attachment A, For Actual Cost.

Line	Comm Ln Desc	Qty	Unit Issue	Unit Price	Ln Total Or Contract Amount
12	Ditching Daytime Mobilization	0.00000	LS	2500.000000	0.00

Comm Code	Manufacturer	Specification	Model #
24000000			

Commodity Line Comments:

Extended Description:

See Attached Pricing Page- Attachment A, For Actual Cost.

Line	Comm Ln Desc	Qty	Unit Issue	Unit Price	Ln Total Or Contract Amount
13	Ditching Nighttime Mobilization.	0.00000	LS	5000.000000	0.00

Comm Code	Manufacturer	Specification	Model #
24000000			

Commodity Line Comments:

Extended Description:

See Attached Pricing Page- Attachment A, For Actual Cost.

Line	Comm Ln Desc	Qty	Unit Issue	Unit Price	Ln Total Or Contract Amount
14	Ditching On-Site Mobilization	0.00000	LS	1000.000000	0.00

Comm Code	Manufacturer	Specification	Model #
24000000			

Commodity Line Comments:

Extended Description:

See Attached Pricing Page- Attachment A, For Actual Cost.

Line	Comm Ln Desc	Qty	Unit Issue	Unit Price	Ln Total Or Contract Amount
15	15" Type F Trench	0.00000	LF	125.000000	0.00

Comm Code	Manufacturer	Specification	Model #
72141100			

Commodity Line Comments:

Extended Description:

See Attached Pricing Page- Attachment A, For Actual Cost.

Line	Comm Ln Desc	Qty	Unit Issue	Unit Price	Ln Total Or Contract Amount
16	18" Type F Trench	0.00000	LF	125.000000	0.00

Comm Code	Manufacturer	Specification	Model #
72141100			

Commodity Line Comments:

Extended Description:

See Attached Pricing Page- Attachment A, For Actual Cost.

Line	Comm Ln Desc	Qty	Unit Issue	Unit Price	Ln Total Or Contract Amount
17	24" Type F Trench	0.00000	LF	125.000000	0.00

Comm Code	Manufacturer	Specification	Model #
72141100			

Commodity Line Comments:

Extended Description:

See Attached Pricing Page- Attachment A, For Actual Cost.

Line	Comm Ln Desc	Qty	Unit Issue	Unit Price	Ln Total Or Contract Amount
18	30" Type F Trench	0.00000	LF	125.000000	0.00

Comm Code	Manufacturer	Specification	Model #
72141100			

Commodity Line Comments:

Extended Description:

See Attached Pricing Page- Attachment A, For Actual Cost.

Line	Comm Ln Desc	Qty	Unit Issue	Unit Price	Ln Total Or Contract Amount
19	36" Type F Trench	0.00000	LF	150.000000	0.00

Comm Code	Manufacturer	Specification	Model #
72141100			

Commodity Line Comments:

Extended Description:

See Attached Pricing Page- Attachment A, For Actual Cost.

Line	Comm Ln Desc	Qty	Unit Issue	Unit Price	Ln Total Or Contract Amount
20	42" Type F Trench	0.00000	LF	250.000000	0.00

Comm Code	Manufacturer	Specification	Model #
72141100			

Commodity Line Comments:

Extended Description:

See Attached Pricing Page- Attachment A, For Actual Cost.

Line	Comm Ln Desc	Qty	Unit Issue	Unit Price	Ln Total Or Contract Amount
21	48" Type F Trench	0.00000	LF	250.000000	0.00

Comm Code	Manufacturer	Specification	Model #
72141100			

Commodity Line Comments:

Extended Description:

See Attached Pricing Page- Attachment A, For Actual Cost.

Line	Comm Ln Desc	Qty	Unit Issue	Unit Price	Ln Total Or Contract Amount
22	54" Type F Trench	0.00000	LF	250.000000	0.00

Comm Code	Manufacturer	Specification	Model #
72141100			

Commodity Line Comments:

Extended Description:

See Attached Pricing Page- Attachment A, For Actual Cost.

Line	Comm Ln Desc	Qty	Unit Issue	Unit Price	Ln Total Or Contract Amount
23	60" Type f Trench	0.00000	LF	250.000000	0.00

Comm Code	Manufacturer	Specification	Model #
72141100			

Commodity Line Comments:

Extended Description:

See Attached Pricing Page- Attachment A, For Actual Cost.

Line	Comm Ln Desc	Qty	Unit Issue	Unit Price	Ln Total Or Contract Amount
24	Pipe Repair/Replacement backfill for F Trench (mat+first5mi)	0.00000	CY	475.000000	0.00

Comm Code	Manufacturer	Specification	Model #
72141100			

Commodity Line Comments:

Extended Description:

See Attached Pricing Page- Attachment A, For Actual Cost.

Line	Comm Ln Desc	Qty	Unit Issue	Unit Price	Ln Total Or Contract Amount
25	Additional Haul per truck load over 5mi, Backfill F Trench	0.00000	MILE	9.000000	0.00

Comm Code	Manufacturer	Specification	Model #
72141100			

Commodity Line Comments:

Extended Description:

See Attached Pricing Page- Attachment A, For Actual Cost.

Line	Comm Ln Desc	Qty	Unit Issue	Unit Price	Ln Total Or Contract Amount
26	Safe Access & Egress Surcharge depth of 5ft to 10ft	0.00000	LS	2750.000000	0.00

Comm Code	Manufacturer	Specification	Model #
72141100			

Commodity Line Comments:

Extended Description:

See Attached Pricing Page- Attachment A, For Actual Cost.

Line	Comm Ln Desc	Qty	Unit Issue	Unit Price	Ln Total Or Contract Amount
27	Safe Access & Egress Surcharge depth of 10ft to 15ft	0.00000	LS	5500.000000	0.00

Comm Code	Manufacturer	Specification	Model #
72141100			

Commodity Line Comments:

Extended Description:

See Attached Pricing Page- Attachment A, For Actual Cost.

Line	Comm Ln Desc	Qty	Unit Issue	Unit Price	Ln Total Or Contract Amount
28	Safe Access & Egress Surcharge depth 15ft to 20ft	0.00000	LS	6800.000000	0.00

Comm Code	Manufacturer	Specification	Model #
72141100			

Commodity Line Comments:

Extended Description:

See Attached Pricing Page- Attachment A, For Actual Cost.

Line	Comm Ln Desc	Qty	Unit Issue	Unit Price	Ln Total Or Contract Amount
29	Pipe Repair/Replacement Waste Haul by Vendor -truck/driver	0.00000	HOUR	150.000000	0.00

Comm Code	Manufacturer	Specification	Model #
72153507			

Commodity Line Comments:

Extended Description:

See Attached Pricing Page- Attachment A, For Actual Cost.

Line	Comm Ln Desc	Qty	Unit Issue	Unit Price	Ln Total Or Contract Amount
30	Pipe Repair/Replacement Daytime Mobilization	0.00000	LS	2500.000000	0.00

Comm Code	Manufacturer	Specification	Model #
24000000			

Commodity Line Comments:

Extended Description:

See Attached Pricing Page- Attachment A, For Actual Cost.

Line	Comm Ln Desc	Qty	Unit Issue	Unit Price	Ln Total Or Contract Amount
31	Pipe Repair/Replacement Nighttime Mobilization	0.00000	LS	5000.000000	0.00

Comm Code	Manufacturer	Specification	Model #
24000000			

Commodity Line Comments:

Extended Description:

See Attached Pricing Page- Attachment A, For Actual Cost.

Line	Comm Ln Desc	Qty	Unit Issue	Unit Price	Ln Total Or Contract Amount
32	Pipe Repair/Replacement On-Site Mobilization	0.00000	LS	750.000000	0.00

Comm Code	Manufacturer	Specification	Model #
24000000			

Commodity Line Comments:

Extended Description:

See Attached Pricing Page- Attachment A, For Actual Cost.

Line	Comm Ln Desc	Qty	Unit Issue	Unit Price	Ln Total Or Contract Amount
33	Pothole Repair (Per Project Size Range)	0.00000	MILE	11500.000000	0.00

Comm Code	Manufacturer	Specification	Model #
72141100			

Commodity Line Comments:

Extended Description:

See Attached Pricing Page- Attachment A, For Actual Cost.

Line	Comm Ln Desc	Qty	Unit Issue	Unit Price	Ln Total Or Contract Amount
34	Base Failure Repair, Asphalt (Per Project Size Range)	0.00000	MILE	12100.000000	0.00

Comm Code	Manufacturer	Specification	Model #
72141100			

Commodity Line Comments:

Extended Description:

See Attached Pricing Page- Attachment A, For Actual Cost.

Line	Comm Ln Desc	Qty	Unit Issue	Unit Price	Ln Total Or Contract Amount
35	Base Failure Repair, Stone (Per Project Size Range)	0.00000	MILE	19500.000000	0.00

Comm Code	Manufacturer	Specification	Model #
72141100			

Commodity Line Comments:

Extended Description:

See Attached Pricing Page- Attachment A, For Actual Cost.

Line	Comm Ln Desc	Qty	Unit Issue	Unit Price	Ln Total Or Contract Amount
36	Edge Failure Repair (Per Project Size Range)	0.00000	MILE	32500.000000	0.00

Comm Code	Manufacturer	Specification	Model #
72141100			

Commodity Line Comments:

Extended Description:

See Attached Pricing Page- Attachment A, For Actual Cost.

Line	Comm Ln Desc	Qty	Unit Issue	Unit Price	Ln Total Or Contract Amount
37	Haul by Vendor First Ton Mile	0.00000	MILE	22000.000000	0.00

Comm Code	Manufacturer	Specification	Model #
72141100			

Commodity Line Comments:

Extended Description:

See Attached Pricing Page- Attachment A, For Actual Cost.

Line	Comm Ln Desc	Qty	Unit Issue	Unit Price	Ln Total Or Contract Amount
38	Haul by Vendor Each Additional Mile (Ton Mile)	0.00000	MILE	23000.000000	0.00

Comm Code	Manufacturer	Specification	Model #
72141100			

Commodity Line Comments:

Extended Description:

See Attached Pricing Page- Attachment A, For Actual Cost.

Line	Comm Ln Desc	Qty	Unit Issue	Unit Price	Ln Total Or Contract Amount
39	Waste Haul by Vendor per truck/driver	0.00000	HOUR	43000.000000	0.00

Comm Code	Manufacturer	Specification	Model #
72153507			

Commodity Line Comments:

Extended Description:

See Attached Pricing Page- Attachment A, For Actual Cost.

Line	Comm Ln Desc	Qty	Unit Issue	Unit Price	Ln Total Or Contract Amount
40	Off-Season Plant Opening First Day	0.00000	DAY	67000.000000	0.00

Comm Code	Manufacturer	Specification	Model #
72141100			

Commodity Line Comments:

Extended Description:

See Attached Pricing Page- Attachment A, For Actual Cost.

Line	Comm Ln Desc	Qty	Unit Issue	Unit Price	Ln Total Or Contract Amount
41	Off-Season Plant Opening Each Additional Day	0.00000	DAY	21600.000000	0.00

Comm Code	Manufacturer	Specification	Model #
72141100			

Commodity Line Comments:

Extended Description:

See Attached Pricing Page- Attachment A, For Actual Cost.

Line	Comm Ln Desc	Qty	Unit Issue	Unit Price	Ln Total Or Contract Amount
42	Asphalt Pavement Repair Daytime Mobilization	0.00000	LS	25750.000000	0.00

Comm Code	Manufacturer	Specification	Model #
24000000			

Commodity Line Comments:

Extended Description:

See Attached Pricing Page- Attachment A, For Actual Cost.

Line	Comm Ln Desc	Qty	Unit Issue	Unit Price	Ln Total Or Contract Amount
43	Asphalt Pavement Repair Nighttime Mobilization	0.00000	LS	47100.000000	0.00

Comm Code	Manufacturer	Specification	Model #
24000000			

Commodity Line Comments:

Extended Description:

See Attached Pricing Page- Attachment A, For Actual Cost.

Line	Comm Ln Desc	Qty	Unit Issue	Unit Price	Ln Total Or Contract Amount
44	Asphalt Pavement Repair On-Site Mobilization	0.00000	LS	119000.000000	0.00

Comm Code	Manufacturer	Specification	Model #
24000000			

Commodity Line Comments:

Extended Description:

See Attached Pricing Page- Attachment A, For Actual Cost.



**State of West Virginia
Agency Request for Quote
Highways**

Proc Folder: 1593441			Reason for Modification:
Doc Description: Ditch, Pipe and Asphalt Repair and Maintenance by the Vendor			
Proc Type: Agency Master Agreement			
Date Issued	Solicitation Closes	Solicitation No	Version
2025-01-08	2025-01-23 10:30	ARFQ 0803 DOT2500000026	1

BID RECEIVING LOCATION

PROCUREMENT DIVISION
 DIVISION OF HIGHWAYS
 BLDG 6 RM 340A
 1900 KANAWHA BLVD E
 CHARLESTON WV 25305
 US

VENDOR

Vendor Customer Code: 000000160630
Vendor Name : Cast & Baker Corporation
Address : 2214 Washington Road
Street : 2214 Washingto Road
City : Canonsburg
State : Pennsylvania **Country :** USA **Zip :** 15317
Principal Contact : Michael J. Baker
Vendor Contact Phone: 724-745-6430 **Extension:**

FOR INFORMATION CONTACT THE BUYER
 Jeromie F Lanham
 304-720-7383
 jeromie.f.lanham@wv.gov

Vendor Signature X  **Michael J. Baker FEIN# 25-1428005** **DATE 1/20/25**

All offers subject to all terms and conditions contained in this solicitation

ADDITIONAL INFORMATION

THE WEST VIRGINIA DEPARTMENT OF TRANSPORTATION - PROCUREMENT DIVISION - OPEN-END CONTRACT FOR DITCH, PIPE AND ASPHALT REPAIR AND MAINTENANCE PER THE ATTACHED DOCUMENTS.

QUESTIONS REGARDING THE SOLICITATION MUST BE SUBMITTED IN WRITING TO DOTPROCUREMENTTECHQUES@WV.GOV PRIOR TO THE QUESTION PERIOD DEADLINE CONTAINED IN THE INSTRUCTIONS TO VENDORS SUBMITTING BIDS.

*****NOTICE*****

WE DO NOT ACCEPT EMAIL BIDS

MUST USE ONE THE FOLLOWING TO SUBMIT A BID:

- * UPLOAD TO OASIS
- * HAND DELIVERY
- * MAIL IN HARD COPY
- * FAX TO 304-558-0047

MAKE SURE YOU DOWNLOAD ALL INFORMATION - THE COMPLETE SOLICITATION - PRICING PAGES - SIGN THE PAGES THAT NEED SIGNED

PLEASE NOTE THAT TO BE AWARDED THIS CONTRACT YOU WILL NEED TO BE REGISTERED WITH WV STATE PURCHASING DIVISION, AND COMPLIANT WITH SEVERAL AGENCIES SUCH AS THE WVSOS, TAX DEPARTMENT, WORKER'S COMPENSATION, AND UNEMPLOYMENT INSURANCE.

INVOICE TO		SHIP TO	
VARIOUS AGENCY LOCATIONS AS INDICATED BY ORDER		VARIOUS AGENCY LOCATIONS AS INDICATED BY ORDER	
No City	WV	No City	WV
US		US	

Line	Comm Ln Desc	Qty	Unit Issue	Unit Price	Total Price
1	Pilot Truck and Driver	0.00000	DAY		

Comm Code	Manufacturer	Specification	Model #
46161500			

Extended Description:
See Attached Pricing Page- Attachment A, For Actual Cost.

INVOICE TO	SHIP TO
------------	---------

VARIOUS AGENCY
LOCATIONS
AS INDICATED BY ORDER

VARIOUS AGENCY
LOCATIONS
AS INDICATED BY ORDER

No City WV
US

No City WV
US

Line	Comm Ln Desc	Qty	Unit Issue	Unit Price	Total Price
2	Traffic Control Devices	0.00000	UNIT		

Comm Code	Manufacturer	Specification	Model #
46161500			

Extended Description:
See Attached Pricing Page- Attachment A, For Actual Cost.

INVOICE TO	SHIP TO
------------	---------

VARIOUS AGENCY
LOCATIONS
AS INDICATED BY ORDER

VARIOUS AGENCY
LOCATIONS
AS INDICATED BY ORDER

No City WV
US

No City WV
US

Line	Comm Ln Desc	Qty	Unit Issue	Unit Price	Total Price
3	Traffic Flagger	0.00000	HOUR		

Comm Code	Manufacturer	Specification	Model #
46161500			

Extended Description:
See Attached Pricing Page- Attachment A, For Actual Cost.

INVOICE TO		SHIP TO	
VARIOUS AGENCY LOCATIONS AS INDICATED BY ORDER		VARIOUS AGENCY LOCATIONS AS INDICATED BY ORDER	
No City	WV	No City	WV
US		US	

Line	Comm Ln Desc	Qty	Unit Issue	Unit Price	Total Price
4	Arrow Board	0.00000	DAY		

Comm Code	Manufacturer	Specification	Model #
46161500			

Extended Description:
See Attached Pricing Page- Attachment A, For Actual Cost.

INVOICE TO		SHIP TO	
VARIOUS AGENCY LOCATIONS AS INDICATED BY ORDER		VARIOUS AGENCY LOCATIONS AS INDICATED BY ORDER	
No City	WV	No City	WV
US		US	

Line	Comm Ln Desc	Qty	Unit Issue	Unit Price	Total Price
5	Ditching (Shoulder Mile)	0.00000	MILE		

Comm Code	Manufacturer	Specification	Model #
72141003			

Extended Description:
See Attached Pricing Page- Attachment A, For Actual Cost.

INVOICE TO		SHIP TO	
VARIOUS AGENCY LOCATIONS AS INDICATED BY ORDER		VARIOUS AGENCY LOCATIONS AS INDICATED BY ORDER	
No City	WV	No City	WV
US		US	

Line	Comm Ln Desc	Qty	Unit Issue	Unit Price	Total Price
6	Correcting Deep Ditches	0.00000	TON		

Comm Code	Manufacturer	Specification	Model #
72141003			

Extended Description:
See Attached Pricing Page- Attachment A, For Actual Cost.

INVOICE TO		SHIP TO	
VARIOUS AGENCY LOCATIONS AS INDICATED BY ORDER		VARIOUS AGENCY LOCATIONS AS INDICATED BY ORDER	
No City	WV	No City	WV
US		US	

Line	Comm Ln Desc	Qty	Unit Issue	Unit Price	Total Price
7	Restoring Shoulders and Shoulder Stone	0.00000	TON		

Comm Code	Manufacturer	Specification	Model #
72141003			

Extended Description:
See Attached Pricing Page- Attachment A, For Actual Cost.

INVOICE TO	SHIP TO
------------	---------

VARIOUS AGENCY
LOCATIONS
AS INDICATED BY ORDER

VARIOUS AGENCY
LOCATIONS
AS INDICATED BY ORDER

No City WV
US

No City WV
US

Line	Comm Ln Desc	Qty	Unit Issue	Unit Price	Total Price
8	Shoulder Stone Placement	0.00000	TON		

Comm Code	Manufacturer	Specification	Model #
72141003			

Extended Description:
See Attached Pricing Page- Attachment A, For Actual Cost.

INVOICE TO	SHIP TO
------------	---------

VARIOUS AGENCY
LOCATIONS
AS INDICATED BY ORDER

VARIOUS AGENCY
LOCATIONS
AS INDICATED BY ORDER

No City WV
US

No City WV
US

Line	Comm Ln Desc	Qty	Unit Issue	Unit Price	Total Price
9	Ditching Haul by Vendor for Items 6, 7 & 8 (Ton Mile)	0.00000	MILE		

Comm Code	Manufacturer	Specification	Model #
72141003			

Extended Description:
See Attached Pricing Page- Attachment A, For Actual Cost.

INVOICE TO	SHIP TO
------------	---------

VARIOUS AGENCY
LOCATIONS
AS INDICATED BY ORDER

VARIOUS AGENCY
LOCATIONS
AS INDICATED BY ORDER

No City WV
US

No City WV
US

Line	Comm Ln Desc	Qty	Unit Issue	Unit Price	Total Price
10	Ditching Haul for Items 6, 7 & 8 Addl' Mile (Ton Mile)	0.00000	MILE		

Comm Code	Manufacturer	Specification	Model #
72141003			

Extended Description:
See Attached Pricing Page- Attachment A, For Actual Cost.

INVOICE TO	SHIP TO
------------	---------

VARIOUS AGENCY
LOCATIONS
AS INDICATED BY ORDER

VARIOUS AGENCY
LOCATIONS
AS INDICATED BY ORDER

No City WV
US

No City WV
US

Line	Comm Ln Desc	Qty	Unit Issue	Unit Price	Total Price
11	Ditching Waste Haul by Vendor per Truck/ Driver	0.00000	HOUR		

Comm Code	Manufacturer	Specification	Model #
72153507			

Extended Description:
See Attached Pricing Page- Attachment A, For Actual Cost.

INVOICE TO		SHIP TO	
VARIOUS AGENCY LOCATIONS AS INDICATED BY ORDER		VARIOUS AGENCY LOCATIONS AS INDICATED BY ORDER	
No City	WV	No City	WV
US		US	

Line	Comm Ln Desc	Qty	Unit Issue	Unit Price	Total Price
12	Ditching Daytime Mobilization	0.00000	LS		

Comm Code	Manufacturer	Specification	Model #
24000000			

Extended Description:
See Attached Pricing Page- Attachment A, For Actual Cost.

INVOICE TO		SHIP TO	
VARIOUS AGENCY LOCATIONS AS INDICATED BY ORDER		VARIOUS AGENCY LOCATIONS AS INDICATED BY ORDER	
No City	WV	No City	WV
US		US	

Line	Comm Ln Desc	Qty	Unit Issue	Unit Price	Total Price
13	Ditching Nighttime Mobilization.	0.00000	LS		

Comm Code	Manufacturer	Specification	Model #
24000000			

Extended Description:
See Attached Pricing Page- Attachment A, For Actual Cost.

INVOICE TO	SHIP TO
------------	---------

VARIOUS AGENCY
LOCATIONS
AS INDICATED BY ORDER

VARIOUS AGENCY
LOCATIONS
AS INDICATED BY ORDER

No City WV
US

No City WV
US

Line	Comm Ln Desc	Qty	Unit Issue	Unit Price	Total Price
14	Ditching On-Site Mobilization	0.00000	LS		

Comm Code	Manufacturer	Specification	Model #
24000000			

Extended Description:

See Attached Pricing Page- Attachment A, For Actual Cost.

INVOICE TO	SHIP TO
------------	---------

VARIOUS AGENCY
LOCATIONS
AS INDICATED BY ORDER

VARIOUS AGENCY
LOCATIONS
AS INDICATED BY ORDER

No City WV
US

No City WV
US

Line	Comm Ln Desc	Qty	Unit Issue	Unit Price	Total Price
15	15" Type F Trench	0.00000	LF		

Comm Code	Manufacturer	Specification	Model #
72141100			

Extended Description:

See Attached Pricing Page- Attachment A, For Actual Cost.

INVOICE TO	SHIP TO
------------	---------

VARIOUS AGENCY
LOCATIONS
AS INDICATED BY ORDER

VARIOUS AGENCY
LOCATIONS
AS INDICATED BY ORDER

No City WV
US

No City WV
US

Line	Comm Ln Desc	Qty	Unit Issue	Unit Price	Total Price
16	18" Type F Trench	0.00000	LF		

Comm Code	Manufacturer	Specification	Model #
72141100			

Extended Description:
See Attached Pricing Page- Attachment A, For Actual Cost.

INVOICE TO	SHIP TO
------------	---------

VARIOUS AGENCY
LOCATIONS
AS INDICATED BY ORDER

VARIOUS AGENCY
LOCATIONS
AS INDICATED BY ORDER

No City WV
US

No City WV
US

Line	Comm Ln Desc	Qty	Unit Issue	Unit Price	Total Price
17	24" Type F Trench	0.00000	LF		

Comm Code	Manufacturer	Specification	Model #
72141100			

Extended Description:
See Attached Pricing Page- Attachment A, For Actual Cost.

INVOICE TO	SHIP TO
------------	---------

VARIOUS AGENCY
LOCATIONS
AS INDICATED BY ORDER

VARIOUS AGENCY
LOCATIONS
AS INDICATED BY ORDER

No City WV
US

No City WV
US

Line	Comm Ln Desc	Qty	Unit Issue	Unit Price	Total Price
18	30" Type F Trench	0.00000	LF		

Comm Code	Manufacturer	Specification	Model #
72141100			

Extended Description:
See Attached Pricing Page- Attachment A, For Actual Cost.

INVOICE TO	SHIP TO
------------	---------

VARIOUS AGENCY
LOCATIONS
AS INDICATED BY ORDER

VARIOUS AGENCY
LOCATIONS
AS INDICATED BY ORDER

No City WV
US

No City WV
US

Line	Comm Ln Desc	Qty	Unit Issue	Unit Price	Total Price
19	36" Type F Trench	0.00000	LF		

Comm Code	Manufacturer	Specification	Model #
72141100			

Extended Description:
See Attached Pricing Page- Attachment A, For Actual Cost.

INVOICE TO	SHIP TO
------------	---------

VARIOUS AGENCY
LOCATIONS
AS INDICATED BY ORDER

VARIOUS AGENCY
LOCATIONS
AS INDICATED BY ORDER

No City WV
US

No City WV
US

Line	Comm Ln Desc	Qty	Unit Issue	Unit Price	Total Price
20	42" Type F Trench	0.00000	LF		

Comm Code	Manufacturer	Specification	Model #
72141100			

Extended Description:
See Attached Pricing Page- Attachment A, For Actual Cost.

INVOICE TO	SHIP TO
------------	---------

VARIOUS AGENCY
LOCATIONS
AS INDICATED BY ORDER

VARIOUS AGENCY
LOCATIONS
AS INDICATED BY ORDER

No City WV
US

No City WV
US

Line	Comm Ln Desc	Qty	Unit Issue	Unit Price	Total Price
21	48" Type F Trench	0.00000	LF		

Comm Code	Manufacturer	Specification	Model #
72141100			

Extended Description:
See Attached Pricing Page- Attachment A, For Actual Cost.

INVOICE TO	SHIP TO
------------	---------

VARIOUS AGENCY
LOCATIONS
AS INDICATED BY ORDER

VARIOUS AGENCY
LOCATIONS
AS INDICATED BY ORDER

No City WV
US

No City WV
US

Line	Comm Ln Desc	Qty	Unit Issue	Unit Price	Total Price
22	54" Type F Trench	0.00000	LF		

Comm Code	Manufacturer	Specification	Model #
72141100			

Extended Description:
See Attached Pricing Page- Attachment A, For Actual Cost.

INVOICE TO	SHIP TO
------------	---------

VARIOUS AGENCY
LOCATIONS
AS INDICATED BY ORDER

VARIOUS AGENCY
LOCATIONS
AS INDICATED BY ORDER

No City WV
US

No City WV
US

Line	Comm Ln Desc	Qty	Unit Issue	Unit Price	Total Price
23	60" Type f Trench	0.00000	LF		

Comm Code	Manufacturer	Specification	Model #
72141100			

Extended Description:
See Attached Pricing Page- Attachment A, For Actual Cost.

INVOICE TO	SHIP TO
------------	---------

VARIOUS AGENCY
LOCATIONS
AS INDICATED BY ORDER

VARIOUS AGENCY
LOCATIONS
AS INDICATED BY ORDER

No City WV
US

No City WV
US

Line	Comm Ln Desc	Qty	Unit Issue	Unit Price	Total Price
24	Pipe Repair/Replacement backfill for F Trench (mat+first5mi)	0.00000	CY		

Comm Code	Manufacturer	Specification	Model #
72141100			

Extended Description:
See Attached Pricing Page- Attachment A, For Actual Cost.

INVOICE TO	SHIP TO
------------	---------

VARIOUS AGENCY
LOCATIONS
AS INDICATED BY ORDER

VARIOUS AGENCY
LOCATIONS
AS INDICATED BY ORDER

No City WV
US

No City WV
US

Line	Comm Ln Desc	Qty	Unit Issue	Unit Price	Total Price
25	Additional Haul per truck load over 5mi, Backfill F Trench	0.00000	MILE		

Comm Code	Manufacturer	Specification	Model #
72141100			

Extended Description:
See Attached Pricing Page- Attachment A, For Actual Cost.

INVOICE TO		SHIP TO	
VARIOUS AGENCY LOCATIONS AS INDICATED BY ORDER		VARIOUS AGENCY LOCATIONS AS INDICATED BY ORDER	
No City	WV	No City	WV
US		US	

Line	Comm Ln Desc	Qty	Unit Issue	Unit Price	Total Price
26	Safe Access & Egress Surcharge depth of 5ft to 10ft	0.00000	LS		

Comm Code	Manufacturer	Specification	Model #
72141100			

Extended Description:
See Attached Pricing Page- Attachment A, For Actual Cost.

INVOICE TO		SHIP TO	
VARIOUS AGENCY LOCATIONS AS INDICATED BY ORDER		VARIOUS AGENCY LOCATIONS AS INDICATED BY ORDER	
No City	WV	No City	WV
US		US	

Line	Comm Ln Desc	Qty	Unit Issue	Unit Price	Total Price
27	Safe Access & Egress Surcharge depth of 10ft to 15ft	0.00000	LS		

Comm Code	Manufacturer	Specification	Model #
72141100			

Extended Description:
See Attached Pricing Page- Attachment A, For Actual Cost.

INVOICE TO	SHIP TO
------------	---------

VARIOUS AGENCY
LOCATIONS
AS INDICATED BY ORDER

VARIOUS AGENCY
LOCATIONS
AS INDICATED BY ORDER

No City WV
US

No City WV
US

Line	Comm Ln Desc	Qty	Unit Issue	Unit Price	Total Price
28	Safe Access & Egress Surcharge depth 15ft to 20ft	0.00000	LS		

Comm Code	Manufacturer	Specification	Model #
72141100			

Extended Description:
See Attached Pricing Page- Attachment A, For Actual Cost.

INVOICE TO	SHIP TO
------------	---------

VARIOUS AGENCY
LOCATIONS
AS INDICATED BY ORDER

VARIOUS AGENCY
LOCATIONS
AS INDICATED BY ORDER

No City WV
US

No City WV
US

Line	Comm Ln Desc	Qty	Unit Issue	Unit Price	Total Price
29	Pipe Repair/Replacement Waste Haul by Vendor -truck/driver	0.00000	HOUR		

Comm Code	Manufacturer	Specification	Model #
72153507			

Extended Description:
See Attached Pricing Page- Attachment A, For Actual Cost.

INVOICE TO	SHIP TO
------------	---------

VARIOUS AGENCY
LOCATIONS
AS INDICATED BY ORDER

VARIOUS AGENCY
LOCATIONS
AS INDICATED BY ORDER

No City WV
US

No City WV
US

Line	Comm Ln Desc	Qty	Unit Issue	Unit Price	Total Price
30	Pipe Repair/Replacement Daytime Mobilization	0.00000	LS		

Comm Code	Manufacturer	Specification	Model #
24000000			

Extended Description:
See Attached Pricing Page- Attachment A, For Actual Cost.

INVOICE TO	SHIP TO
------------	---------

VARIOUS AGENCY
LOCATIONS
AS INDICATED BY ORDER

VARIOUS AGENCY
LOCATIONS
AS INDICATED BY ORDER

No City WV
US

No City WV
US

Line	Comm Ln Desc	Qty	Unit Issue	Unit Price	Total Price
31	Pipe Repair/Replacement Nighttime Mobilization	0.00000	LS		

Comm Code	Manufacturer	Specification	Model #
24000000			

Extended Description:
See Attached Pricing Page- Attachment A, For Actual Cost.

INVOICE TO	SHIP TO
------------	---------

VARIOUS AGENCY
LOCATIONS
AS INDICATED BY ORDER

VARIOUS AGENCY
LOCATIONS
AS INDICATED BY ORDER

No City WV
US

No City WV
US

Line	Comm Ln Desc	Qty	Unit Issue	Unit Price	Total Price
32	Pipe Repair/Replacement On-Site Mobilization	0.00000	LS		

Comm Code	Manufacturer	Specification	Model #
24000000			

Extended Description:
See Attached Pricing Page- Attachment A, For Actual Cost.

INVOICE TO	SHIP TO
------------	---------

VARIOUS AGENCY
LOCATIONS
AS INDICATED BY ORDER

VARIOUS AGENCY
LOCATIONS
AS INDICATED BY ORDER

No City WV
US

No City WV
US

Line	Comm Ln Desc	Qty	Unit Issue	Unit Price	Total Price
33	Pothole Repair (Per Project Size Range)	0.00000	MILE		

Comm Code	Manufacturer	Specification	Model #
72141100			

Extended Description:
See Attached Pricing Page- Attachment A, For Actual Cost.

INVOICE TO	SHIP TO
------------	---------

VARIOUS AGENCY
LOCATIONS
AS INDICATED BY ORDER

VARIOUS AGENCY
LOCATIONS
AS INDICATED BY ORDER

No City WV
US

No City WV
US

Line	Comm Ln Desc	Qty	Unit Issue	Unit Price	Total Price
34	Base Failure Repair, Asphalt (Per Project Size Range)	0.00000	MILE		

Comm Code	Manufacturer	Specification	Model #
72141100			

Extended Description:
See Attached Pricing Page- Attachment A, For Actual Cost.

INVOICE TO	SHIP TO
------------	---------

VARIOUS AGENCY
LOCATIONS
AS INDICATED BY ORDER

VARIOUS AGENCY
LOCATIONS
AS INDICATED BY ORDER

No City WV
US

No City WV
US

Line	Comm Ln Desc	Qty	Unit Issue	Unit Price	Total Price
35	Base Failure Repair, Stone (Per Project Size Range)	0.00000	MILE		

Comm Code	Manufacturer	Specification	Model #
72141100			

Extended Description:
See Attached Pricing Page- Attachment A, For Actual Cost.

INVOICE TO	SHIP TO
------------	---------

VARIOUS AGENCY
LOCATIONS
AS INDICATED BY ORDER

VARIOUS AGENCY
LOCATIONS
AS INDICATED BY ORDER

No City WV
US

No City WV
US

Line	Comm Ln Desc	Qty	Unit Issue	Unit Price	Total Price
36	Edge Failure Repair (Per Project Size Range)	0.00000	MILE		

Comm Code	Manufacturer	Specification	Model #
72141100			

Extended Description:
See Attached Pricing Page- Attachment A, For Actual Cost.

INVOICE TO	SHIP TO
------------	---------

VARIOUS AGENCY
LOCATIONS
AS INDICATED BY ORDER

VARIOUS AGENCY
LOCATIONS
AS INDICATED BY ORDER

No City WV
US

No City WV
US

Line	Comm Ln Desc	Qty	Unit Issue	Unit Price	Total Price
37	Haul by Vendor First Ton Mile	0.00000	MILE		

Comm Code	Manufacturer	Specification	Model #
72141100			

Extended Description:
See Attached Pricing Page- Attachment A, For Actual Cost.

INVOICE TO		SHIP TO	
VARIOUS AGENCY LOCATIONS AS INDICATED BY ORDER		VARIOUS AGENCY LOCATIONS AS INDICATED BY ORDER	
No City	WV	No City	WV
US		US	

Line	Comm Ln Desc	Qty	Unit Issue	Unit Price	Total Price
38	Haul by Vendor Each Additional Mile (Ton Mile)	0.00000	MILE		

Comm Code	Manufacturer	Specification	Model #
72141100			

Extended Description:
See Attached Pricing Page- Attachment A, For Actual Cost.

INVOICE TO		SHIP TO	
VARIOUS AGENCY LOCATIONS AS INDICATED BY ORDER		VARIOUS AGENCY LOCATIONS AS INDICATED BY ORDER	
No City	WV	No City	WV
US		US	

Line	Comm Ln Desc	Qty	Unit Issue	Unit Price	Total Price
39	Waste Haul by Vendor per truck/driver	0.00000	HOUR		

Comm Code	Manufacturer	Specification	Model #
72153507			

Extended Description:
See Attached Pricing Page- Attachment A, For Actual Cost.

INVOICE TO	SHIP TO
------------	---------

VARIOUS AGENCY
LOCATIONS
AS INDICATED BY ORDER

VARIOUS AGENCY
LOCATIONS
AS INDICATED BY ORDER

No City WV
US

No City WV
US

Line	Comm Ln Desc	Qty	Unit Issue	Unit Price	Total Price
40	Off-Season Plant Opening First Day	0.00000	DAY		

Comm Code	Manufacturer	Specification	Model #
72141100			

Extended Description:
See Attached Pricing Page- Attachment A, For Actual Cost.

INVOICE TO	SHIP TO
------------	---------

VARIOUS AGENCY
LOCATIONS
AS INDICATED BY ORDER

VARIOUS AGENCY
LOCATIONS
AS INDICATED BY ORDER

No City WV
US

No City WV
US

Line	Comm Ln Desc	Qty	Unit Issue	Unit Price	Total Price
41	Off-Season Plant Opening Each Additional Day	0.00000	DAY		

Comm Code	Manufacturer	Specification	Model #
72141100			

Extended Description:
See Attached Pricing Page- Attachment A, For Actual Cost.

INVOICE TO	SHIP TO
------------	---------

VARIOUS AGENCY
LOCATIONS
AS INDICATED BY ORDER

VARIOUS AGENCY
LOCATIONS
AS INDICATED BY ORDER

No City WV
US

No City WV
US

Line	Comm Ln Desc	Qty	Unit Issue	Unit Price	Total Price
42	Asphalt Pavement Repair Daytime Mobilization	0.00000	LS		

Comm Code	Manufacturer	Specification	Model #
24000000			

Extended Description:
See Attached Pricing Page- Attachment A, For Actual Cost.

INVOICE TO	SHIP TO
------------	---------

VARIOUS AGENCY
LOCATIONS
AS INDICATED BY ORDER

VARIOUS AGENCY
LOCATIONS
AS INDICATED BY ORDER

No City WV
US

No City WV
US

Line	Comm Ln Desc	Qty	Unit Issue	Unit Price	Total Price
43	Asphalt Pavement Repair Nighttime Mobilization	0.00000	LS		

Comm Code	Manufacturer	Specification	Model #
24000000			

Extended Description:
See Attached Pricing Page- Attachment A, For Actual Cost.

INVOICE TO	SHIP TO
------------	---------

VARIOUS AGENCY
LOCATIONS
AS INDICATED BY ORDER

VARIOUS AGENCY
LOCATIONS
AS INDICATED BY ORDER

No City WV
US

No City WV
US

Line	Comm Ln Desc	Qty	Unit Issue	Unit Price	Total Price
44	Asphalt Pavement Repair On-Site Mobilization	0.00000	LS		

Comm Code	Manufacturer	Specification	Model #
24000000			

Extended Description:
See Attached Pricing Page- Attachment A, For Actual Cost.

SCHEDULE OF EVENTS

<u>Line</u>	<u>Event</u>	<u>Event Date</u>
1	TECHNICAL QUESTIONS DUE BY 10:00 AM EST	2025-01-15

	Document Phase	Document Description	Page
DOT2500000026	Final	Ditch, Pipe and Asphalt Repair and Maintenance by the Vendor	25

ADDITIONAL TERMS AND CONDITIONS

See attached document(s) for additional Terms and Conditions



State of West Virginia
Agency Request for Quote
Highways

Proc Folder: 1593441			Reason for Modification:
Doc Description: Ditch, Pipe and Asphalt Repair and Maintenance by the Vendor			
Proc Type: Agency Master Agreement			
Date Issued	Solicitation Closes	Solicitation No	Version
2025-01-08	2025-01-23 10:30	ARFQ 0803 DOT2500000026	1

BID RECEIVING LOCATION

PROCUREMENT DIVISION
DIVISION OF HIGHWAYS
BLDG 6 RM 340A
1900 KANAWHA BLVD E
CHARLESTON WV 25305
US

VENDOR

Vendor Customer Code: 000000160630
Vendor Name : Cast & Baker Corporation
Address : 2214 Washington Road
Street : 2214 Washingto Road
City : Canonsburg
State : Pennsylvania **Country :** USA **Zip :** 15317
Principal Contact : Michael J. Baker
Vendor Contact Phone: 724-745-6430 **Extension:**

FOR INFORMATION CONTACT THE BUYER
Jeromie F Lanham
304-720-7383
jeromie.f.lanham@wv.gov

Vendor Signature X  **Michael J. Baker FEIN# 25-1428005** **DATE 1/20/25**

ADDITIONAL INFORMATION

THE WEST VIRGINIA DEPARTMENT OF TRANSPORTATION - PROCUREMENT DIVISION - OPEN-END CONTRACT FOR DITCH, PIPE AND ASPHALT REPAIR AND MAINTENANCE PER THE ATTACHED DOCUMENTS.

QUESTIONS REGARDING THE SOLICITATION MUST BE SUBMITTED IN WRITING TO DOTPROCUREMENTTECHQUES@WV.GOV PRIOR TO THE QUESTION PERIOD DEADLINE CONTAINED IN THE INSTRUCTIONS TO VENDORS SUBMITTING BIDS.

*****NOTICE*****

WE DO NOT ACCEPT EMAIL BIDS

MUST USE ONE THE FOLLOWING TO SUBMIT A BID:

- * UPLOAD TO OASIS
- * HAND DELIVERY
- * MAIL IN HARD COPY
- * FAX TO 304-558-0047

MAKE SURE YOU DOWNLOAD ALL INFORMATION - THE COMPLETE SOLICITATION - PRICING PAGES - SIGN THE PAGES THAT NEED SIGNED

PLEASE NOTE THAT TO BE AWARDED THIS CONTRACT YOU WILL NEED TO BE REGISTERED WITH WV STATE PURCHASING DIVISION, AND COMPLIANT WITH SEVERAL AGENCIES SUCH AS THE WVSOS, TAX DEPARTMENT, WORKER'S COMPENSATION, AND UNEMPLOYMENT INSURANCE.

INVOICE TO		SHIP TO	
VARIOUS AGENCY LOCATIONS AS INDICATED BY ORDER		VARIOUS AGENCY LOCATIONS AS INDICATED BY ORDER	
No City	WV	No City	WV
US		US	

Line	Comm Ln Desc	Qty	Unit Issue	Unit Price	Total Price
1	Pilot Truck and Driver	0.00000	DAY		

Comm Code	Manufacturer	Specification	Model #
46161500			

Extended Description:

See Attached Pricing Page- Attachment A, For Actual Cost.

INVOICE TO		SHIP TO	
VARIOUS AGENCY LOCATIONS AS INDICATED BY ORDER		VARIOUS AGENCY LOCATIONS AS INDICATED BY ORDER	
No City	WV	No City	WV
US		US	

Line	Comm Ln Desc	Qty	Unit Issue	Unit Price	Total Price
2	Traffic Control Devices	0.00000	UNIT		

Comm Code	Manufacturer	Specification	Model #
46161500			

Extended Description:
See Attached Pricing Page- Attachment A, For Actual Cost.

INVOICE TO		SHIP TO	
VARIOUS AGENCY LOCATIONS AS INDICATED BY ORDER		VARIOUS AGENCY LOCATIONS AS INDICATED BY ORDER	
No City	WV	No City	WV
US		US	

Line	Comm Ln Desc	Qty	Unit Issue	Unit Price	Total Price
3	Traffic Flagger	0.00000	HOUR		

Comm Code	Manufacturer	Specification	Model #
46161500			

Extended Description:
See Attached Pricing Page- Attachment A, For Actual Cost.

INVOICE TO	SHIP TO
------------	---------

VARIOUS AGENCY
LOCATIONS
AS INDICATED BY ORDER

VARIOUS AGENCY
LOCATIONS
AS INDICATED BY ORDER

No City WV
US

No City WV
US

Line	Comm Ln Desc	Qty	Unit Issue	Unit Price	Total Price
4	Arrow Board	0.00000	DAY		

Comm Code	Manufacturer	Specification	Model #
46161500			

Extended Description:
See Attached Pricing Page- Attachment A, For Actual Cost.

INVOICE TO	SHIP TO
------------	---------

VARIOUS AGENCY
LOCATIONS
AS INDICATED BY ORDER

VARIOUS AGENCY
LOCATIONS
AS INDICATED BY ORDER

No City WV
US

No City WV
US

Line	Comm Ln Desc	Qty	Unit Issue	Unit Price	Total Price
5	Ditching (Shoulder Mile)	0.00000	MILE		

Comm Code	Manufacturer	Specification	Model #
72141003			

Extended Description:
See Attached Pricing Page- Attachment A, For Actual Cost.

INVOICE TO		SHIP TO	
VARIOUS AGENCY LOCATIONS AS INDICATED BY ORDER		VARIOUS AGENCY LOCATIONS AS INDICATED BY ORDER	
No City	WV	No City	WV
US		US	

Line	Comm Ln Desc	Qty	Unit Issue	Unit Price	Total Price
6	Correcting Deep Ditches	0.00000	TON		

Comm Code	Manufacturer	Specification	Model #
72141003			

Extended Description:
See Attached Pricing Page- Attachment A, For Actual Cost.

INVOICE TO		SHIP TO	
VARIOUS AGENCY LOCATIONS AS INDICATED BY ORDER		VARIOUS AGENCY LOCATIONS AS INDICATED BY ORDER	
No City	WV	No City	WV
US		US	

Line	Comm Ln Desc	Qty	Unit Issue	Unit Price	Total Price
7	Restoring Shoulders and Shoulder Stone	0.00000	TON		

Comm Code	Manufacturer	Specification	Model #
72141003			

Extended Description:
See Attached Pricing Page- Attachment A, For Actual Cost.

INVOICE TO		SHIP TO	
VARIOUS AGENCY LOCATIONS AS INDICATED BY ORDER		VARIOUS AGENCY LOCATIONS AS INDICATED BY ORDER	
No City	WV	No City	WV
US		US	

Line	Comm Ln Desc	Qty	Unit Issue	Unit Price	Total Price
8	Shoulder Stone Placement	0.00000	TON		

Comm Code	Manufacturer	Specification	Model #
72141003			

Extended Description:
See Attached Pricing Page- Attachment A, For Actual Cost.

INVOICE TO		SHIP TO	
VARIOUS AGENCY LOCATIONS AS INDICATED BY ORDER		VARIOUS AGENCY LOCATIONS AS INDICATED BY ORDER	
No City	WV	No City	WV
US		US	

Line	Comm Ln Desc	Qty	Unit Issue	Unit Price	Total Price
9	Ditching Haul by Vendor for Items 6, 7 & 8 (Ton Mile)	0.00000	MILE		

Comm Code	Manufacturer	Specification	Model #
72141003			

Extended Description:
See Attached Pricing Page- Attachment A, For Actual Cost.

INVOICE TO		SHIP TO	
VARIOUS AGENCY LOCATIONS AS INDICATED BY ORDER		VARIOUS AGENCY LOCATIONS AS INDICATED BY ORDER	
No City	WV	No City	WV
US		US	

Line	Comm Ln Desc	Qty	Unit Issue	Unit Price	Total Price
10	Ditching Haul for Items 6, 7 & 8 Addl' Mile (Ton Mile)	0.00000	MILE		

Comm Code	Manufacturer	Specification	Model #
72141003			

Extended Description:
See Attached Pricing Page- Attachment A, For Actual Cost.

INVOICE TO		SHIP TO	
VARIOUS AGENCY LOCATIONS AS INDICATED BY ORDER		VARIOUS AGENCY LOCATIONS AS INDICATED BY ORDER	
No City	WV	No City	WV
US		US	

Line	Comm Ln Desc	Qty	Unit Issue	Unit Price	Total Price
11	Ditching Waste Haul by Vendor per Truck/ Driver	0.00000	HOUR		

Comm Code	Manufacturer	Specification	Model #
72153507			

Extended Description:
See Attached Pricing Page- Attachment A, For Actual Cost.

INVOICE TO		SHIP TO	
VARIOUS AGENCY LOCATIONS AS INDICATED BY ORDER		VARIOUS AGENCY LOCATIONS AS INDICATED BY ORDER	
No City	WV	No City	WV
US		US	

Line	Comm Ln Desc	Qty	Unit Issue	Unit Price	Total Price
12	Ditching Daytime Mobilization	0.00000	LS		

Comm Code	Manufacturer	Specification	Model #
24000000			

Extended Description:
See Attached Pricing Page- Attachment A, For Actual Cost.

INVOICE TO		SHIP TO	
VARIOUS AGENCY LOCATIONS AS INDICATED BY ORDER		VARIOUS AGENCY LOCATIONS AS INDICATED BY ORDER	
No City	WV	No City	WV
US		US	

Line	Comm Ln Desc	Qty	Unit Issue	Unit Price	Total Price
13	Ditching Nighttime Mobilization.	0.00000	LS		

Comm Code	Manufacturer	Specification	Model #
24000000			

Extended Description:
See Attached Pricing Page- Attachment A, For Actual Cost.

INVOICE TO		SHIP TO	
VARIOUS AGENCY LOCATIONS AS INDICATED BY ORDER		VARIOUS AGENCY LOCATIONS AS INDICATED BY ORDER	
No City	WV	No City	WV
US		US	

Line	Comm Ln Desc	Qty	Unit Issue	Unit Price	Total Price
14	Ditching On-Site Mobilization	0.00000	LS		

Comm Code	Manufacturer	Specification	Model #
24000000			

Extended Description:
See Attached Pricing Page- Attachment A, For Actual Cost.

INVOICE TO		SHIP TO	
VARIOUS AGENCY LOCATIONS AS INDICATED BY ORDER		VARIOUS AGENCY LOCATIONS AS INDICATED BY ORDER	
No City	WV	No City	WV
US		US	

Line	Comm Ln Desc	Qty	Unit Issue	Unit Price	Total Price
15	15" Type F Trench	0.00000	LF		

Comm Code	Manufacturer	Specification	Model #
72141100			

Extended Description:
See Attached Pricing Page- Attachment A, For Actual Cost.

INVOICE TO		SHIP TO	
VARIOUS AGENCY LOCATIONS AS INDICATED BY ORDER		VARIOUS AGENCY LOCATIONS AS INDICATED BY ORDER	
No City	WV	No City	WV
US		US	

Line	Comm Ln Desc	Qty	Unit Issue	Unit Price	Total Price
16	18" Type F Trench	0.00000	LF		

Comm Code	Manufacturer	Specification	Model #
72141100			

Extended Description:
See Attached Pricing Page- Attachment A, For Actual Cost.

INVOICE TO		SHIP TO	
VARIOUS AGENCY LOCATIONS AS INDICATED BY ORDER		VARIOUS AGENCY LOCATIONS AS INDICATED BY ORDER	
No City	WV	No City	WV
US		US	

Line	Comm Ln Desc	Qty	Unit Issue	Unit Price	Total Price
17	24" Type F Trench	0.00000	LF		

Comm Code	Manufacturer	Specification	Model #
72141100			

Extended Description:
See Attached Pricing Page- Attachment A, For Actual Cost.

INVOICE TO		SHIP TO	
VARIOUS AGENCY LOCATIONS AS INDICATED BY ORDER		VARIOUS AGENCY LOCATIONS AS INDICATED BY ORDER	
No City	WV	No City	WV
US		US	

Line	Comm Ln Desc	Qty	Unit Issue	Unit Price	Total Price
18	30" Type F Trench	0.00000	LF		

Comm Code	Manufacturer	Specification	Model #
72141100			

Extended Description:
See Attached Pricing Page- Attachment A, For Actual Cost.

INVOICE TO		SHIP TO	
VARIOUS AGENCY LOCATIONS AS INDICATED BY ORDER		VARIOUS AGENCY LOCATIONS AS INDICATED BY ORDER	
No City	WV	No City	WV
US		US	

Line	Comm Ln Desc	Qty	Unit Issue	Unit Price	Total Price
19	36" Type F Trench	0.00000	LF		

Comm Code	Manufacturer	Specification	Model #
72141100			

Extended Description:
See Attached Pricing Page- Attachment A, For Actual Cost.

INVOICE TO		SHIP TO	
VARIOUS AGENCY LOCATIONS AS INDICATED BY ORDER		VARIOUS AGENCY LOCATIONS AS INDICATED BY ORDER	
No City	WV	No City	WV
US		US	

Line	Comm Ln Desc	Qty	Unit Issue	Unit Price	Total Price
20	42" Type F Trench	0.00000	LF		

Comm Code	Manufacturer	Specification	Model #
72141100			

Extended Description:
See Attached Pricing Page- Attachment A, For Actual Cost.

INVOICE TO		SHIP TO	
VARIOUS AGENCY LOCATIONS AS INDICATED BY ORDER		VARIOUS AGENCY LOCATIONS AS INDICATED BY ORDER	
No City	WV	No City	WV
US		US	

Line	Comm Ln Desc	Qty	Unit Issue	Unit Price	Total Price
21	48" Type F Trench	0.00000	LF		

Comm Code	Manufacturer	Specification	Model #
72141100			

Extended Description:
See Attached Pricing Page- Attachment A, For Actual Cost.

INVOICE TO		SHIP TO	
VARIOUS AGENCY LOCATIONS AS INDICATED BY ORDER		VARIOUS AGENCY LOCATIONS AS INDICATED BY ORDER	
No City	WV	No City	WV
US		US	

Line	Comm Ln Desc	Qty	Unit Issue	Unit Price	Total Price
22	54" Type F Trench	0.00000	LF		

Comm Code	Manufacturer	Specification	Model #
72141100			

Extended Description:
See Attached Pricing Page- Attachment A, For Actual Cost.

INVOICE TO		SHIP TO	
VARIOUS AGENCY LOCATIONS AS INDICATED BY ORDER		VARIOUS AGENCY LOCATIONS AS INDICATED BY ORDER	
No City	WV	No City	WV
US		US	

Line	Comm Ln Desc	Qty	Unit Issue	Unit Price	Total Price
23	60" Type f Trench	0.00000	LF		

Comm Code	Manufacturer	Specification	Model #
72141100			

Extended Description:
See Attached Pricing Page- Attachment A, For Actual Cost.

INVOICE TO		SHIP TO	
VARIOUS AGENCY LOCATIONS AS INDICATED BY ORDER		VARIOUS AGENCY LOCATIONS AS INDICATED BY ORDER	
No City	WV	No City	WV
US		US	

Line	Comm Ln Desc	Qty	Unit Issue	Unit Price	Total Price
24	Pipe Repair/Replacement backfill for F Trench (mat+first5mi)	0.00000	CY		

Comm Code	Manufacturer	Specification	Model #
72141100			

Extended Description:
See Attached Pricing Page- Attachment A, For Actual Cost.

INVOICE TO		SHIP TO	
VARIOUS AGENCY LOCATIONS AS INDICATED BY ORDER		VARIOUS AGENCY LOCATIONS AS INDICATED BY ORDER	
No City	WV	No City	WV
US		US	

Line	Comm Ln Desc	Qty	Unit Issue	Unit Price	Total Price
25	Additional Haul per truck load over 5mi, Backfill F Trench	0.00000	MILE		

Comm Code	Manufacturer	Specification	Model #
72141100			

Extended Description:
See Attached Pricing Page- Attachment A, For Actual Cost.

INVOICE TO		SHIP TO	
VARIOUS AGENCY LOCATIONS AS INDICATED BY ORDER		VARIOUS AGENCY LOCATIONS AS INDICATED BY ORDER	
No City	WV	No City	WV
US		US	

Line	Comm Ln Desc	Qty	Unit Issue	Unit Price	Total Price
26	Safe Access & Egress Surcharge depth of 5ft to 10ft	0.00000	LS		

Comm Code	Manufacturer	Specification	Model #
72141100			

Extended Description:
See Attached Pricing Page- Attachment A, For Actual Cost.

INVOICE TO		SHIP TO	
VARIOUS AGENCY LOCATIONS AS INDICATED BY ORDER		VARIOUS AGENCY LOCATIONS AS INDICATED BY ORDER	
No City	WV	No City	WV
US		US	

Line	Comm Ln Desc	Qty	Unit Issue	Unit Price	Total Price
27	Safe Access & Egress Surcharge depth of 10ft to 15ft	0.00000	LS		

Comm Code	Manufacturer	Specification	Model #
72141100			

Extended Description:
See Attached Pricing Page- Attachment A, For Actual Cost.

INVOICE TO		SHIP TO	
VARIOUS AGENCY LOCATIONS AS INDICATED BY ORDER		VARIOUS AGENCY LOCATIONS AS INDICATED BY ORDER	
No City	WV	No City	WV
US		US	

Line	Comm Ln Desc	Qty	Unit Issue	Unit Price	Total Price
28	Safe Access & Egress Surcharge depth 15ft to 20ft	0.00000	LS		

Comm Code	Manufacturer	Specification	Model #
72141100			

Extended Description:
See Attached Pricing Page- Attachment A, For Actual Cost.

INVOICE TO		SHIP TO	
VARIOUS AGENCY LOCATIONS AS INDICATED BY ORDER		VARIOUS AGENCY LOCATIONS AS INDICATED BY ORDER	
No City	WV	No City	WV
US		US	

Line	Comm Ln Desc	Qty	Unit Issue	Unit Price	Total Price
29	Pipe Repair/Replacement Waste Haul by Vendor -truck/driver	0.00000	HOUR		

Comm Code	Manufacturer	Specification	Model #
72153507			

Extended Description:
See Attached Pricing Page- Attachment A, For Actual Cost.

INVOICE TO		SHIP TO	
VARIOUS AGENCY LOCATIONS AS INDICATED BY ORDER		VARIOUS AGENCY LOCATIONS AS INDICATED BY ORDER	
No City	WV	No City	WV
US		US	

Line	Comm Ln Desc	Qty	Unit Issue	Unit Price	Total Price
30	Pipe Repair/Replacement Daytime Mobilization	0.00000	LS		

Comm Code	Manufacturer	Specification	Model #
24000000			

Extended Description:
See Attached Pricing Page- Attachment A, For Actual Cost.

INVOICE TO		SHIP TO	
VARIOUS AGENCY LOCATIONS AS INDICATED BY ORDER		VARIOUS AGENCY LOCATIONS AS INDICATED BY ORDER	
No City	WV	No City	WV
US		US	

Line	Comm Ln Desc	Qty	Unit Issue	Unit Price	Total Price
31	Pipe Repair/Replacement Nighttime Mobilization	0.00000	LS		

Comm Code	Manufacturer	Specification	Model #
24000000			

Extended Description:
See Attached Pricing Page- Attachment A, For Actual Cost.

INVOICE TO		SHIP TO	
VARIOUS AGENCY LOCATIONS AS INDICATED BY ORDER		VARIOUS AGENCY LOCATIONS AS INDICATED BY ORDER	
No City	WV	No City	WV
US		US	

Line	Comm Ln Desc	Qty	Unit Issue	Unit Price	Total Price
32	Pipe Repair/Replacement On-Site Mobilization	0.00000	LS		

Comm Code	Manufacturer	Specification	Model #
24000000			

Extended Description:
See Attached Pricing Page- Attachment A, For Actual Cost.

INVOICE TO		SHIP TO	
VARIOUS AGENCY LOCATIONS AS INDICATED BY ORDER		VARIOUS AGENCY LOCATIONS AS INDICATED BY ORDER	
No City	WV	No City	WV
US		US	

Line	Comm Ln Desc	Qty	Unit Issue	Unit Price	Total Price
33	Pothole Repair (Per Project Size Range)	0.00000	MILE		

Comm Code	Manufacturer	Specification	Model #
72141100			

Extended Description:
See Attached Pricing Page- Attachment A, For Actual Cost.

INVOICE TO		SHIP TO	
VARIOUS AGENCY LOCATIONS AS INDICATED BY ORDER		VARIOUS AGENCY LOCATIONS AS INDICATED BY ORDER	
No City	WV	No City	WV
US		US	

Line	Comm Ln Desc	Qty	Unit Issue	Unit Price	Total Price
34	Base Failure Repair, Asphalt (Per Project Size Range)	0.00000	MILE		

Comm Code	Manufacturer	Specification	Model #
72141100			

Extended Description:
See Attached Pricing Page- Attachment A, For Actual Cost.

INVOICE TO		SHIP TO	
VARIOUS AGENCY LOCATIONS AS INDICATED BY ORDER		VARIOUS AGENCY LOCATIONS AS INDICATED BY ORDER	
No City	WV	No City	WV
US		US	

Line	Comm Ln Desc	Qty	Unit Issue	Unit Price	Total Price
35	Base Failure Repair, Stone (Per Project Size Range)	0.00000	MILE		

Comm Code	Manufacturer	Specification	Model #
72141100			

Extended Description:
See Attached Pricing Page- Attachment A, For Actual Cost.

INVOICE TO		SHIP TO	
VARIOUS AGENCY LOCATIONS AS INDICATED BY ORDER		VARIOUS AGENCY LOCATIONS AS INDICATED BY ORDER	
No City	WV	No City	WV
US		US	

Line	Comm Ln Desc	Qty	Unit Issue	Unit Price	Total Price
36	Edge Failure Repair (Per Project Size Range)	0.00000	MILE		

Comm Code	Manufacturer	Specification	Model #
72141100			

Extended Description:
See Attached Pricing Page- Attachment A, For Actual Cost.

INVOICE TO		SHIP TO	
VARIOUS AGENCY LOCATIONS AS INDICATED BY ORDER		VARIOUS AGENCY LOCATIONS AS INDICATED BY ORDER	
No City	WV	No City	WV
US		US	

Line	Comm Ln Desc	Qty	Unit Issue	Unit Price	Total Price
37	Haul by Vendor First Ton Mile	0.00000	MILE		

Comm Code	Manufacturer	Specification	Model #
72141100			

Extended Description:
See Attached Pricing Page- Attachment A, For Actual Cost.

INVOICE TO		SHIP TO	
VARIOUS AGENCY LOCATIONS AS INDICATED BY ORDER		VARIOUS AGENCY LOCATIONS AS INDICATED BY ORDER	
No City	WV	No City	WV
US		US	

Line	Comm Ln Desc	Qty	Unit Issue	Unit Price	Total Price
38	Haul by Vendor Each Additional Mile (Ton Mile)	0.00000	MILE		

Comm Code	Manufacturer	Specification	Model #
72141100			

Extended Description:
See Attached Pricing Page- Attachment A, For Actual Cost.

INVOICE TO		SHIP TO	
VARIOUS AGENCY LOCATIONS AS INDICATED BY ORDER		VARIOUS AGENCY LOCATIONS AS INDICATED BY ORDER	
No City	WV	No City	WV
US		US	

Line	Comm Ln Desc	Qty	Unit Issue	Unit Price	Total Price
39	Waste Haul by Vendor per truck/driver	0.00000	HOUR		

Comm Code	Manufacturer	Specification	Model #
72153507			

Extended Description:
See Attached Pricing Page- Attachment A, For Actual Cost.

INVOICE TO		SHIP TO	
VARIOUS AGENCY LOCATIONS AS INDICATED BY ORDER		VARIOUS AGENCY LOCATIONS AS INDICATED BY ORDER	
No City	WV	No City	WV
US		US	

Line	Comm Ln Desc	Qty	Unit Issue	Unit Price	Total Price
40	Off-Season Plant Opening First Day	0.00000	DAY		

Comm Code	Manufacturer	Specification	Model #
72141100			

Extended Description:
See Attached Pricing Page- Attachment A, For Actual Cost.

INVOICE TO		SHIP TO	
VARIOUS AGENCY LOCATIONS AS INDICATED BY ORDER		VARIOUS AGENCY LOCATIONS AS INDICATED BY ORDER	
No City	WV	No City	WV
US		US	

Line	Comm Ln Desc	Qty	Unit Issue	Unit Price	Total Price
41	Off-Season Plant Opening Each Additional Day	0.00000	DAY		

Comm Code	Manufacturer	Specification	Model #
72141100			

Extended Description:
See Attached Pricing Page- Attachment A, For Actual Cost.

INVOICE TO		SHIP TO	
VARIOUS AGENCY LOCATIONS AS INDICATED BY ORDER		VARIOUS AGENCY LOCATIONS AS INDICATED BY ORDER	
No City	WV	No City	WV
US		US	

Line	Comm Ln Desc	Qty	Unit Issue	Unit Price	Total Price
42	Asphalt Pavement Repair Daytime Mobilization	0.00000	LS		

Comm Code	Manufacturer	Specification	Model #
24000000			

Extended Description:
See Attached Pricing Page- Attachment A, For Actual Cost.

INVOICE TO		SHIP TO	
VARIOUS AGENCY LOCATIONS AS INDICATED BY ORDER		VARIOUS AGENCY LOCATIONS AS INDICATED BY ORDER	
No City	WV	No City	WV
US		US	

Line	Comm Ln Desc	Qty	Unit Issue	Unit Price	Total Price
43	Asphalt Pavement Repair Nighttime Mobilization	0.00000	LS		

Comm Code	Manufacturer	Specification	Model #
24000000			

Extended Description:
See Attached Pricing Page- Attachment A, For Actual Cost.

INVOICE TO	SHIP TO
------------	---------

VARIOUS AGENCY
LOCATIONS
AS INDICATED BY ORDER

VARIOUS AGENCY
LOCATIONS
AS INDICATED BY ORDER

No City WV
US

No City WV
US

Line	Comm Ln Desc	Qty	Unit Issue	Unit Price	Total Price
44	Asphalt Pavement Repair On-Site Mobilization	0.00000	LS		

Comm Code	Manufacturer	Specification	Model #
24000000			

Extended Description:
See Attached Pricing Page- Attachment A, For Actual Cost.

SCHEDULE OF EVENTS

<u>Line</u>	<u>Event</u>	<u>Event Date</u>
1	TECHNICAL QUESTIONS DUE BY 10:00 AM EST	2025-01-15

**INSTRUCTIONS TO VENDORS SUBMITTING BIDS
(Agency Delegated Procurements Only)**

1. REVIEW DOCUMENTS THOROUGHLY: The attached documents contain a solicitation for bids. Please read these instructions and all documents attached in their entirety. These instructions provide critical information about requirements that if overlooked could lead to disqualification of a Vendor's bid. All bids must be submitted in accordance with the provisions contained in these instructions and the Solicitation. Failure to do so may result in disqualification of Vendor's bid.

2. MANDATORY TERMS: The Solicitation may contain mandatory provisions identified by the use of the words "must," "will," and "shall." Failure to comply with a mandatory term in the Solicitation will result in bid disqualification.

2A. PREBID MEETING: The item identified below shall apply to this Solicitation.

A pre-bid meeting will not be held prior to bid opening

A MANDATORY PRE-BID meeting will be held at the following place and time:

All Vendors submitting a bid must attend the mandatory pre-bid meeting. Failure to attend the mandatory pre-bid meeting shall result in disqualification of the Vendor's bid. No one individual is permitted to represent more than one vendor at the pre-bid meeting. Any individual that does attempt to represent two or more vendors will be required to select one vendor to which the individual's attendance will be attributed. The vendors not selected will be deemed to have not attended the pre-bid meeting unless another individual attended on their behalf. The required attribution of attendance to a single vendor should be addressed during the pre-bid but may occur at any time deemed appropriate by the Purchasing Division.

An attendance sheet provided at the pre-bid meeting shall serve as the official document verifying attendance. Any person attending the pre-bid meeting on behalf of a Vendor must list on the attendance sheet his or her name and the name of the Vendor he or she is representing.

Additionally, the person attending the pre-bid meeting should include the Vendor's E-Mail address, phone number, and Fax number on the attendance sheet. It is the Vendor's responsibility to locate the attendance sheet and provide the required information. Failure to complete the attendance sheet as required may result in disqualification of Vendor's bid.

All Vendors should arrive prior to the starting time for the pre-bid. Vendors who arrive after the starting time but prior to the end of the pre-bid will be permitted to sign in, but are charged with knowing all matters discussed at the pre-bid.

Questions submitted at least five business days prior to a scheduled pre-bid will be discussed at the pre-bid meeting if possible. Any discussions or answers to questions at the pre-bid meeting are preliminary in nature and are non-binding. Official and binding answers to questions will be published in a written addendum to the Solicitation prior to bid opening.

3. VENDOR QUESTION DEADLINE: Vendors may submit questions relating to this Solicitation to the Agency Contact. Questions must be submitted in writing. All questions must be submitted on or before the date listed below and to the address listed below to be considered. A written response will be published in a Solicitation addendum if a response is possible and appropriate. Non-written discussions, conversations, or questions and answers regarding this Solicitation are preliminary in nature and are nonbinding.

Submitted emails should have the solicitation number in the subject line.

Question Submission Deadline: 01/15/2025 10:00 AM EST

Submit Questions to:

DOTPROCUREMENTTECHQUES@WV.GOV

Email: DOTPROCUREMENTTECHQUES@WV.GOV

4. BID SUBMISSION: All bids must be submitted electronically through wvOASIS or signed and delivered by the Vendor to the Agency on or before the date and time of the bid opening. Any bid received by the Agency staff is considered to be in the possession of the Agency and will not be returned for any reason.

4A. BID SUBMISSION

A bid that is not submitted electronically through wvOASIS should contain the information listed below on the face of the envelope or the bid may be rejected by the Agency.

SEALED BID: DITCH, PIPE AND ASPHALT REPAIR AND MAINTENANCE

BUYER: JEROMIE LANHAM

SOLICITATION NO.: ARFQ DOT2500000026

BID OPENING DATE: 01/23/2025

BID OPENING TIME: 10:30 AM

FAX NUMBER: 304-558-0047

5. ADDENDUM ACKNOWLEDGEMENT: Changes or revisions to this Solicitation will be made by an official addendum issued by the Agency. Vendor should acknowledge receipt of all addenda issued with this Solicitation by completing an Addendum Acknowledgment Form, a copy of which is included herewith. Failure to acknowledge addenda may result in bid disqualification. The addendum acknowledgement should be submitted with the bid to expedite document processing.

6. BID FORMATTING: Vendor should type or electronically enter the information onto its bid to prevent errors in the evaluation. Failure to type or electronically enter the information may result in bid disqualification.

7. ALTERNATE MODEL OR BRAND: Unless the box below is checked, any model, brand, or specification listed in this Solicitation establishes the acceptable level of quality only and is not intended to reflect a preference for, or in any way favor, a particular brand or vendor. Vendors may bid alternates to a listed model or brand provided that the alternate is at least equal to the model or brand and complies with the required specifications. The equality of any alternate being bid shall be determined by the State at its sole discretion. Any Vendor bidding an alternate model or brand should clearly identify the alternate items in its bid and should include manufacturer's specifications, industry literature, and/or any other relevant documentation demonstrating the equality of the alternate items. Failure to provide information for alternate items may be grounds for rejection of a Vendor's bid.

This Solicitation is based upon a standardized commodity established under West Virginia Code § 5A-3-61. Vendors are expected to bid the standardized commodity identified. Failure to bid the standardized commodity will result in your firm's bid being rejected.

8. EXCEPTIONS AND CLARIFICATIONS: The Solicitation contains the specifications that shall form the basis of a contractual agreement. Vendor shall clearly mark any exceptions, clarifications, or other proposed modifications in its bid. Exceptions to, clarifications of, or modifications of a requirement or term and condition of the Solicitation may result in bid disqualification.

9. REGISTRATION: Prior to Contract award, the apparent successful Vendor must be properly registered with the West Virginia Purchasing Division and must have paid the \$125 fee, if applicable.

10. UNIT PRICE: Unit prices shall prevail in cases of a discrepancy in the Vendor's bid.

11. PREFERENCE: Vendor Preference may be requested in purchases of motor vehicles or construction and maintenance equipment and machinery used in highway and other infrastructure projects. Any request for preference must be submitted in writing with the bid, must specifically identify the preference requested with reference to the applicable subsection of West Virginia Code § 5A-3-37, and must include with the bid any information necessary to evaluate and confirm the applicability of the requested preference. A request form to help facilitate the request can be found at: <http://www.state.wv.us/admin/purchase/vrc/Venpref.pdf>.

11A. RECIPROCAL PREFERENCE: The State of West Virginia applies a reciprocal preference to all solicitations for commodities and printing in accordance with W. Va. Code § 5A-3-37(b). In effect, if reciprocal preference is requested by a West Virginia resident vendor, non-resident vendors receiving a preference in their home states, will see that same preference granted to West Virginia resident vendors bidding against them in West Virginia. Any request for reciprocal preference must include with the bid any information necessary to evaluate and confirm the applicability of the preference. A request form to help facilitate the request can be found at: <http://www.state.wv.us/admin/purchase/vrc/Venpref.pdf>.

12. SMALL, WOMEN-OWNED, OR MINORITY-OWNED BUSINESSES: For any solicitations publicly advertised for bid, in accordance with West Virginia Code §5A-3-37 and W. Va. CSR § 148-22-9, any non-resident vendor certified as a small, women-owned, or minority-owned business under W. Va. CSR § 148-22-9 shall be provided the same preference made available to any resident vendor. Any non-resident small, women-owned, or minority-owned business must identify itself as such in writing, must submit that writing to the Purchasing Division with its bid, and must be properly certified under W. Va. CSR § 148-22-9 prior to contract award to receive the preferences made available to resident vendors. Preference for a non-resident small, women-owned, or minority owned business shall be applied in accordance with W. Va. CSR § 148-22-9.

13. ELECTRONIC FILE ACCESS RESTRICTIONS: Vendor must ensure that its submission in *vvOASIS* can be accessed and viewed by the Agency staff immediately upon bid opening. The Agency will consider any file that cannot be immediately accessed and viewed at the time of the bid opening (such as, encrypted files, password protected files, or incompatible files) to be blank or incomplete as context requires, and therefore unacceptable. A vendor will not be permitted to unencrypt files, remove password protections, or resubmit documents after bid opening to make a file viewable if those documents are required with the bid. A Vendor may be required to provide document passwords or removed access restrictions to allow the Agency to print or electronically save documents provided that those documents are viewable by the Agency prior to obtaining the password or removing the access restriction.

14. NON-RESPONSIBLE: The Purchasing Division Director reserves the right to reject the bid of any vendor as Non-Responsible in accordance with W. Va. Code of State Rules § 148-1-5.3, when the Director determines that the vendor submitting the bid does not have the capability to fully perform, or lacks the integrity and reliability to assure good-faith performance.”

15. ACCEPTANCE/REJECTION: The State may accept or reject any bid in whole, or in part in accordance with W. Va. Code of State Rules § 148-1-4.5. and § 148-1-6.4.b.”

16. YOUR SUBMISSION IS A PUBLIC DOCUMENT: Vendor’s entire response to the Solicitation and the resulting Contract are public documents. As public documents, they will be disclosed to the public following the bid/proposal opening or award of the contract, as required by the competitive bidding laws of West Virginia Code §§ 5A-3-1 et seq., 5-22-1 et seq., 5G-1-1 et seq. and the Freedom of Information Act in West Virginia Code §§ 29B-1-1 et seq.

DO NOT SUBMIT MATERIAL YOU CONSIDER TO BE CONFIDENTIAL, A TRADE SECRET, OR OTHERWISE NOT SUBJECT TO PUBLIC DISCLOSURE.

Submission of any bid, proposal, or other document to the Purchasing Division constitutes your explicit consent to the subsequent public disclosure of the bid, proposal, or document. The Purchasing Division will disclose any document labeled “confidential,” “proprietary,” “trade secret,” “private,” or labeled with any other claim against public disclosure of the documents, to include any “trade secrets” as defined by West Virginia Code § 47-22-1 et seq. All submissions are subject to public disclosure without notice.

**GENERAL TERMS AND CONDITIONS:
(Agency Delegated Procurements Only)**

1. CONTRACTUAL AGREEMENT: Issuance of an Award Document signed by the Agency and approved as to form by the Attorney General's office, if required, constitutes acceptance by the State of this Contract made by and between the State of West Virginia and the Vendor. Vendor's signature on its bid, or on the Contract if the Contract is not the result of a bid solicitation, signifies Vendor's agreement to be bound by and accept the terms and conditions contained in this Contract.

2. DEFINITIONS: As used in this Solicitation/Contract, the following terms shall have the meanings attributed to them below. Additional definitions may be found in the specifications included with this Solicitation/Contract.

2.1. "Agency" or "Agencies" means the agency, board, commission, or other entity of the State of West Virginia that is identified on the first page of the Solicitation or any other public entity seeking to procure goods or services under this Contract.

2.2. "Bid" or "Proposal" means the vendors submitted response to this solicitation.

2.3. "Contract" means the binding agreement that is entered into between the State and the Vendor to provide the goods or services requested in the Solicitation.

2.4. "Director" means the Director of the West Virginia Department of Administration, Purchasing Division.

2.5. "Purchasing Division" means the West Virginia Department of Administration, Purchasing Division.

2.6. "Award Document" means the document signed by the Agency that identifies the Vendor as the contract holder.

2.7. "Solicitation" means the official notice of an opportunity to supply the State with goods or services.

2.8. "State" means the State of West Virginia and/or any of its agencies, commissions, boards, etc. as context requires.

2.9. "Vendor" or "Vendors" means any entity submitting a bid in response to the Solicitation, the entity that has been selected as the lowest responsible bidder, or the entity that has been awarded the Contract as context requires.

Construction/Project Oversight: This Contract becomes effective on the effective start date listed on the first page of this Contract, identified as the State of West Virginia contract cover page containing the signatures of the State Agency (or another page identified as _____), and continues until the project for which the vendor is providing oversight is complete.

Other: See attached.

4. AUTHORITY TO PROCEED: Vendor is authorized to begin performance of this contract on the date of encumbrance listed on the front page of the Award Document unless either the box for "Fixed Period Contract" or "Fixed Period Contract with Renewals" has been checked in Section 3 above. If either "Fixed Period Contract" or "Fixed Period Contract with Renewals" has been checked, Vendor must not begin work until it receives a separate notice to proceed from the State. The notice to proceed will then be incorporated into the Contract via change order to memorialize the official date that work commenced.

5. QUANTITIES: The quantities required under this Contract shall be determined in accordance with the category that has been identified as applicable to this Contract below.

Open End Contract: Quantities listed in this Solicitation/Award Document are approximations only, based on estimates supplied by the Agency. It is understood and agreed that the Contract shall cover the quantities actually ordered for delivery during the term of the Contract, whether more or less than the quantities shown.

Service: The scope of the service to be provided will be more clearly defined in the specifications included herewith.

Combined Service and Goods: The scope of the service and deliverable goods to be provided will be more clearly defined in the specifications included herewith.

One Time Purchase: This Contract is for the purchase of a set quantity of goods that are identified in the specifications included herewith. Once those items have been delivered, no additional goods may be procured under this Contract without an appropriate change order approved by the Vendor, Agency, Purchasing Division, and Attorney General's office.

Construction: This Contract is for construction activity more fully defined in the specifications.

6. EMERGENCY PURCHASES: The Purchasing Division Director may authorize the Agency to purchase goods or services in the open market that Vendor would otherwise provide under this Contract if those goods or services are for immediate or expedited delivery in an emergency. Emergencies shall include, but are not limited to, delays in transportation or an unanticipated increase in the volume of work. An emergency purchase in the open market, approved by the Purchasing Division Director, shall not constitute a breach of this Contract and shall not entitle the Vendor to any form of compensation or damages. This provision does not excuse the State from fulfilling its obligations under a One Time Purchase contract.

7. REQUIRED DOCUMENTS: All of the items checked below must be provided to the Agency by the Vendor as specified below.

LICENSE(S) / CERTIFICATIONS / PERMITS: In addition to anything required under the Section of the General Terms and Conditions entitled Licensing, the apparent successful Vendor shall furnish proof of the following licenses, certifications, and/or permits upon request and in a form acceptable to the State. The request may be prior to or after contract award at the State's sole discretion.

WV CONTRACTOR'S LICENSE

The apparent successful Vendor shall also furnish proof of any additional licenses or certifications contained in the specifications regardless of whether or not that requirement is listed above.

8. INSURANCE: The apparent successful Vendor shall furnish proof of the insurance identified by a checkmark below on each policy prior to Contract award. The insurance coverages identified below must be maintained throughout the life of this contract. Thirty (30) days prior to the expiration of the insurance policies Vendor shall provide the Agency with proof that the insurance

mandated herein has been continued. Vendor must also provide Agency with immediate notice of any changes in its insurance policies, including but not limited to, policy cancelation, policy reduction, or change in insurers. The apparent successful Vendor shall also furnish proof of any additional insurance requirements contained in the specifications prior to Contract award regardless of whether or not that insurance requirement is listed in this section.

Vendor must maintain:

Commercial General Liability Insurance in at least an amount of:
2,000,000.00 per occurrence.

Automobile Liability Insurance in at least an amount of: 2,000,000.00 per occurrence.

Professional/Malpractice/Errors and Omission Insurance in at least an amount of: _____ per occurrence. Notwithstanding the forgoing, Vendor's are not required to list the State as an additional insured for this type of policy.

Commercial Crime and Third Party Fidelity Insurance in an amount of: _____ per occurrence.

Cyber Liability Insurance in an amount of: _____ per occurrence.

Builders Risk Insurance in an amount equal to 100% of the amount of the Contract.

Pollution Insurance in an amount of: _____ per occurrence.

Aircraft Liability in an amount of: _____ per occurrence.

9. WORKERS' COMPENSATION INSURANCE: Vendor shall comply with laws relating to workers compensation, shall maintain workers' compensation insurance when required, and shall furnish proof of workers' compensation insurance upon request.

10. LIQUIDATED DAMAGES: This clause shall in no way be considered exclusive and shall not limit the State or Agency's right to pursue any other available remedy. Vendor shall pay liquidated damages in the amount specified below or as described in the specifications:

_____ for _____

Liquidated Damages Contained in the Specifications.

Liquidated Damages Are Not Included in this Contract.

11. ACCEPTANCE: Vendor's signature on its bid, or on the certification and signature page, constitutes an offer to the State that cannot be unilaterally withdrawn, signifies that the product or service proposed by vendor meets the mandatory requirements contained in the Solicitation for that product or service, unless otherwise indicated, and signifies acceptance of the terms and conditions contained in the Solicitation unless otherwise indicated.

12. PRICING: The pricing set forth herein is firm for the life of the Contract, unless specified elsewhere within this Solicitation/Contract by the State. A Vendor's inclusion of price adjustment provisions in its bid, without an express authorization from the State in the Solicitation to do so, may result in bid disqualification. Notwithstanding the foregoing, Vendor must extend any publicly advertised sale price to the State and invoice at the lower of the contract price or the publicly advertised sale price.

13. PAYMENT IN ARREARS: Payments for goods/services will be made in arrears only upon receipt of a proper invoice, detailing the goods/services provided or receipt of the goods/services, whichever is later. Notwithstanding the foregoing, payments for software licenses, subscriptions, or maintenance may be paid annually in advance.

14. PAYMENT METHODS: Vendor must accept payment by electronic funds transfer or P-Card. (The State of West Virginia's Purchasing Card program, administered under contract by a banking institution, processes payment for goods and services through state designated credit cards.)

15. ADDITIONAL FEES: Vendor is not permitted to charge additional fees or assess additional charges that were not either expressly provided for in the solicitation published by the State of West Virginia, included in the Contract, or included in the unit price or lump sum bid amount that Vendor is required by the solicitation to provide. Including such fees or charges as notes to the solicitation may result in rejection of vendor's bid. Requesting such fees or charges be paid after the contract has been awarded may result in cancellation of the contract.

16. TAXES: The Vendor shall pay any applicable sales, use, personal property or any other taxes arising out of this Contract and the transactions contemplated thereby. The State of West Virginia is exempt from federal and state taxes and will not pay or reimburse such taxes.

17. FUNDING: This Contract shall continue for the term stated herein, contingent upon funds being appropriated by the Legislature or otherwise being made available. In the event funds are not appropriated or otherwise made available, this Contract becomes void and of no effect beginning on July 1 of the fiscal year for which funding has not been appropriated or otherwise made available. If that occurs, the State may notify the Vendor that an alternative source of funding has been obtained and thereby avoid the automatic termination. Non-appropriation or non-funding shall not be considered an event of default.

18. CANCELLATION: The State reserves the right to cancel this Contract immediately upon written notice to the vendor if the materials or workmanship supplied do not conform to the specifications contained in the Contract. The Agency may also cancel any purchase or Contract upon 30 days written notice to the Vendor in accordance with West Virginia Code of State Rules § 148-1-5.2.b.

19. TIME: Time is of the essence with regard to all matters of time and performance in this Contract.

20. APPLICABLE LAW: This Contract is governed by and interpreted under West Virginia law without giving effect to its choice of law principles. Any information provided in specification manuals, or any other source, verbal or written, which contradicts or violates the West Virginia Constitution, West Virginia Code or West Virginia Code of State Rules is void and of no effect.

20A. VENUE: All legal actions for damages brought by Vendor against the State shall be brought in the West Virginia Claims Commission. Other causes of action must be brought in the West Virginia court authorized by statute to exercise jurisdiction over it.

21. COMPLIANCE WITH LAWS: Vendor shall comply with all applicable federal, state, and local laws, regulations and ordinances. By submitting a bid, Vendor acknowledges that it has reviewed, understands, and will comply with all applicable laws, regulations, and ordinances. Vendor shall notify all subcontractors providing commodities or services related to this Contract that as subcontractors, they too are required to comply with all applicable laws, regulations, and ordinances.

22. ARBITRATION: Any references made to arbitration contained in this Contract, Vendor's bid, or in any American Institute of Architects documents pertaining to this Contract are hereby deleted, void, and of no effect.

23. MODIFICATIONS: This writing is the parties' final expression of intent. Notwithstanding anything contained in this Contract to the contrary, no modification of this Contract shall be binding without mutual written consent of the Agency, and the Vendor.

24. WAIVER: The failure of either party to insist upon a strict performance of any of the terms or provision of this Contract, or to exercise any option, right, or remedy herein contained, shall not be construed as a waiver or a relinquishment for the future of such term, provision, option, right, or remedy, but the same shall continue in full force and effect. Any waiver must be expressly stated in writing and signed by the waiving party.

25. SUBSEQUENT FORMS: The terms and conditions contained in this Contract shall supersede any and all subsequent terms and conditions which may appear on any form documents submitted by Vendor to the Agency or Purchasing Division such as price lists, order forms, invoices, sales agreements, or maintenance agreements, and includes internet websites or other electronic documents. Acceptance or use of Vendor's forms does not constitute acceptance of the terms and conditions contained thereon.

26. ASSIGNMENT: Neither this Contract nor any monies due, or to become due hereunder, may be assigned by the Vendor without the express written consent of the Agency and any other government agency or office that may be required to approve such assignments.

27. WARRANTY: The Vendor expressly warrants that the goods and/or services covered by this Contract will: (a) conform to the specifications, drawings, samples, or other description furnished or specified by the Agency; (b) be merchantable and fit for the purpose intended; and (c) be free from defect in material and workmanship.

28. STATE EMPLOYEES: State employees are not permitted to utilize this Contract for personal use and the Vendor is prohibited from permitting or facilitating the same.

29. PRIVACY, SECURITY, AND CONFIDENTIALITY: The Vendor agrees that it will not disclose to anyone, directly or indirectly, any such personally identifiable information or other confidential information gained from the Agency, unless the individual who is the subject of the information consents to the disclosure in writing or the disclosure is made pursuant to the Agency's policies, procedures, and rules. Vendor further agrees to comply with the Confidentiality Policies and Information Security Accountability Requirements, set forth in www.state.wv.us/admin/purchase/privacy.

30. YOUR SUBMISSION IS A PUBLIC DOCUMENT: Vendor's entire response to the Solicitation and the resulting Contract are public documents. As public documents, they will be disclosed to the public following the bid/proposal opening or award of the contract, as required by the competitive bidding laws of West Virginia Code §§ 5A-3-1 et seq., 5-22-1 et seq., and 5G-1-1 et seq. and the Freedom of Information Act West Virginia Code §§ 29B-1-1 et seq.

DO NOT SUBMIT MATERIAL YOU CONSIDER TO BE CONFIDENTIAL, A TRADE SECRET, OR OTHERWISE NOT SUBJECT TO PUBLIC DISCLOSURE.

Submission of any bid, proposal, or other document to the Purchasing Division constitutes your explicit consent to the subsequent public disclosure of the bid, proposal, or document. The Purchasing Division will disclose any document labeled "confidential," "proprietary," "trade secret," "private," or labeled with any other claim against public disclosure of the documents, to include any "trade secrets" as defined by West Virginia Code § 47-22-1 et seq. All submissions are subject to public disclosure without notice.

31. LICENSING: In accordance with West Virginia Code of State Rules § 148-1-6.1.e, Vendor must be licensed and in good standing in accordance with any and all state and local laws and requirements by any state or local agency of West Virginia, including, but not limited to, the West Virginia Secretary of State's Office, the West Virginia Tax Department, West Virginia Insurance Commission, or any other state agency or political subdivision. Obligations related to political subdivisions may include, but are not limited to, business licensing, business and occupation taxes, inspection compliance, permitting, etc. Upon request, the Vendor must provide all necessary releases to obtain information to enable the Purchasing Division Director or the Agency to verify that the Vendor is licensed and in good standing with the above entities. Vendor shall notify all subcontractors providing commodities or services related to this Contract that as subcontractors, they too are required to be licensed, in good standing, and up-to-date on all state and local obligations as described in this section.

32. ANTITRUST: In submitting a bid to, signing a contract with, or accepting an Award Document from any agency of the State of West Virginia, the Vendor agrees to convey, sell, assign, or transfer to the State of West Virginia all rights, title, and interest in and to all causes of action it may now or hereafter acquire under the antitrust laws of the United States and the State of West Virginia for price fixing and/or unreasonable restraints of trade relating to the particular commodities or services purchased or acquired by the State of West Virginia. Such assignment shall be made and become effective at the time the purchasing agency tenders the initial payment to Vendor.

33. VENDOR NON-CONFLICT: Neither Vendor nor its representatives are permitted to have any interest, nor shall they acquire any interest, direct or indirect, which would compromise the performance of its services hereunder. Any such interests shall be promptly presented in detail to the Agency.

34. VENDOR RELATIONSHIP: The relationship of the Vendor to the State shall be that of an independent contractor and no principal-agent relationship or employer-employee relationship is contemplated or created by this Contract. The Vendor as an independent contractor is solely liable for the acts and omissions of its employees and agents. Vendor shall be responsible for selecting, supervising, and compensating any and all individuals employed pursuant to the terms of this Solicitation and resulting contract. Neither the Vendor, nor any employees or subcontractors of the Vendor, shall be deemed to be employees of the State for any purpose whatsoever. Vendor shall be exclusively responsible for payment of employees and contractors for all wages and salaries, taxes, withholding payments, penalties, fees, fringe benefits, professional liability insurance premiums, contributions to insurance and pension, or other deferred compensation plans, including but not limited to, Workers' Compensation and Social Security obligations, licensing fees, etc. and the filing of all necessary documents, forms, and returns pertinent to all of the foregoing. Vendor shall hold harmless the State, and shall provide the State and Agency with a defense against any and all claims including, but not limited to, the foregoing payments, withholdings, contributions, taxes, Social Security taxes, and employer income tax returns.

35. INDEMNIFICATION: The Vendor agrees to indemnify, defend, and hold harmless the State and the Agency, their officers, and employees from and against: (1) Any claims or losses for services rendered by any subcontractor, person, or firm performing or supplying services, materials, or supplies in connection with the performance of the Contract; (2) Any claims or losses resulting to any person or entity injured or damaged by the Vendor, its officers, employees, or subcontractors by the publication, translation, reproduction, delivery, performance, use, or disposition of any data used under the Contract in a manner not authorized by the Contract, or by Federal or State statutes or regulations; and (3) Any failure of the Vendor, its officers, employees, or subcontractors to observe State and Federal laws including, but not limited to, labor and wage and hour laws.

36. NO DEBT CERTIFICATION: In accordance with West Virginia Code §§ 5A-3-10a and 5-22-1(i), the State is prohibited from awarding a contract to any bidder that owes a debt to the State or a political subdivision of the State. By submitting a bid, or entering into a contract with the State, Vendor is affirming that (1) for construction contracts, the vendor is not in default on any monetary obligation owed to the state or a political subdivision of the state, and (2) for all other contracts, that neither vendor nor any related party owe a debt as defined above and that neither Vendor nor any related party are in employer default as defined in the statute cited above unless the debt or employer default is permitted under the statute.

37. CONFLICT OF INTEREST: Vendor, its officers or members or employees, shall not presently have or acquire an interest, direct or indirect, which would conflict with or compromise the performance of its obligations hereunder. Vendor shall periodically inquire of its officers, members and employees to ensure that a conflict of interest does not arise. Any conflict of interest discovered shall be promptly presented in detail to the Agency.

38. REPORTS: Vendor shall provide the Agency and/or the Purchasing Division with the following reports identified by a checked box below:

Such reports as the Agency and/or the Purchasing Division may request. Requested reports may include, but are not limited to, quantities purchased, agencies utilizing the contract, total contract expenditures by agency, etc.

Quarterly reports detailing the total quantity of purchases in units and dollars, along with a listing of purchases by agency. Quarterly reports should be delivered to the Purchasing Division via email at purchasing.division@wv.gov.

39. BACKGROUND CHECK: In accordance with W. Va. Code § 15-2D-3, the State reserves the right to prohibit a service provider's employees from accessing sensitive or critical information or to be present at the Capitol complex based upon results addressed from a criminal background check. Service providers should contact the West Virginia Division of Protective Services by phone at (304) 558-9911 for more information.

40. PREFERENCE FOR USE OF DOMESTIC STEEL PRODUCTS: Except when authorized by the Director of the Purchasing Division pursuant to W. Va. Code § 5A-3-56, no contractor may use or supply steel products for a State Contract Project other than those steel products made in the United States. A contractor who uses steel products in violation of this section may be subject to civil penalties pursuant to W. Va. Code § 5A-3-56. As used in this section:

a. "State Contract Project" means any erection or construction of, or any addition to, alteration of or other improvement to any building or structure, including, but not limited to, roads or highways, or the installation of any heating or cooling or ventilating plants or other equipment, or the supply of and materials for such projects, pursuant to a contract with the State of West Virginia for which bids were solicited on or after June 6, 2001.

b. "Steel Products" means products rolled, formed, shaped, drawn, extruded, forged, cast, fabricated or otherwise similarly processed, or processed by a combination of two or more of such operations, from steel made by the open hearth, basic oxygen, electric furnace, Bessemer or other steel making process. The Purchasing Division Director may, in writing, authorize the use of foreign steel products if:

c. The cost for each contract item used does not exceed one tenth of one percent (.1%) of the total contract cost or two thousand five hundred dollars (\$2,500.00), whichever is greater. For the purposes of this section, the cost is the value of the steel product as delivered to the project; or

d. The Director of the Purchasing Division determines that specified steel materials are not produced in the United States in sufficient quantity or otherwise are not reasonably available to meet contract requirements.

41. PREFERENCE FOR USE OF DOMESTIC ALUMINUM, GLASS, AND STEEL: In Accordance with W. Va. Code § 5-19-1 et seq., and W. Va. CSR § 148-10-1 et seq., for every contract or subcontract, subject to the limitations contained herein, for the construction, reconstruction, alteration, repair, improvement or maintenance of public works or for the purchase of any item of machinery or equipment to be used at sites of public works, only domestic aluminum, glass or steel products shall be supplied unless the spending officer determines, in writing, after the receipt of offers or bids, (1) that the cost of domestic aluminum, glass or steel products is unreasonable or inconsistent with the public interest of the State of West Virginia, (2) that domestic aluminum, glass or steel products are not produced in sufficient quantities to meet the contract requirements, or (3) the available domestic aluminum, glass, or steel do not meet the contract specifications. This provision only applies to public works contracts awarded in an amount more than fifty thousand dollars (\$50,000) or public works contracts that require more than ten thousand pounds of steel products.

The cost of domestic aluminum, glass, or steel products may be unreasonable if the cost is more than twenty percent (20%) of the bid or offered price for foreign made aluminum, glass, or steel products. If the domestic aluminum, glass or steel products to be supplied or produced in a "substantial labor surplus area", as defined by the United States Department of Labor, the cost of domestic aluminum, glass, or steel products may be unreasonable if the cost is more than thirty percent (30%) of the bid or offered price for foreign made aluminum, glass, or steel products. This preference shall be applied to an item of machinery or equipment, as indicated above, when the

item is a single unit of equipment or machinery manufactured primarily of aluminum, glass or steel, is part of a public works contract and has the sole purpose or of being a permanent part of a single public works project. This provision does not apply to equipment or machinery purchased by a spending unit for use by that spending unit and not as part of a single public works project.

All bids and offers including domestic aluminum, glass or steel products that exceed bid or offer prices including foreign aluminum, glass or steel products after application of the preferences provided in this provision may be reduced to a price equal to or lower than the lowest bid or offer price for foreign aluminum, glass or steel products plus the applicable preference. If the reduced bid or offer prices are made in writing and supersede the prior bid or offer prices, all bids or offers, including the reduced bid or offer prices, will be reevaluated in accordance with this rule.

42. PROHIBITION AGAINST USED OR REFURBISHED: Unless expressly permitted in the solicitation published by the State, Vendor must provide new, unused commodities, and is prohibited from supplying used or refurbished commodities, in fulfilling its responsibilities under this Contract.

43. VOID CONTRACT CLAUSES – This Contract is subject to the provisions of West Virginia Code § 5A-3-62, which automatically voids certain contract clauses that violate State law.

DESIGNATED CONTACT: Vendor appoints the individual identified in this Section as the Contract Administrator and the initial point of contact for matters relating to this Contract.

Michael J. Baker President

(Printed Name and Title)
2214 Washington Road, Canonsburg, PA 15317

(Address)
(724-745-6430) / (724-745-7778)

(Phone Number) / (Fax Number)
mbaker@castandbaker.com

(E-mail address)

CERTIFICATION AND SIGNATURE: By signing below, or submitting documentation through *WV*OASIS, I certify that I have reviewed this Solicitation in its entirety; that I understand the requirements, terms and conditions, and other information contained herein; that this bid, offer or proposal constitutes an offer to the State that cannot be unilaterally withdrawn; that the product or service proposed meets the mandatory requirements contained in the Solicitation for that product or service, unless otherwise stated herein; that the Vendor accepts the terms and conditions contained in the Solicitation, unless otherwise stated herein; that I am submitting this bid, offer or proposal for review and consideration; ; that this bid or offer was made without prior understanding, agreement, or connection with any entity submitting a bid or offer for the same material, supplies, equipment or services; that this bid or offer is in all respects fair and without collusion or fraud; that this Contract is accepted or entered into without any prior understanding, agreement, or connection to any other entity that could be considered a violation of law; that I am authorized by the Vendor to execute and submit this bid, offer, or proposal, or any documents related thereto on Vendor's behalf; that I am authorized to bind the vendor in a contractual relationship; and that to the best of my knowledge, the Vendor has properly registered with any State agency that may require registration.

By signing below, I further certify that I understand this Contract is subject to the provisions of West Virginia Code § 5A-3-62, which automatically voids certain contract clauses that violate State law.

Cast & Baker Corporation

(Company)

(Signature of Authorized Representative)

Michael J. Baker, President

(Printed Name and Title of Authorized Representative)

1/20/25

(Date)

(724-745-6430) (724-745-7778)

(Phone Number) (Fax Number)

REQUEST FOR QUOTATION
Ditch, Pipe, and Asphalt Repair and Maintenance by the Vendor

SPECIFICATIONS

1. **PURPOSE AND SCOPE:** The West Virginia Division of Highways is soliciting bids to establish an open-end contract for roadway maintenance and repair projects at various project sites throughout the State of West Virginia, to include all materials, equipment, and labor by the Vendor to perform ditch maintenance and repair, pipe repair and replacement, and asphalt pavement patching and repair. This contract is intended to supplement the WVDOH work force for such maintenance work.

2. **DEFINITIONS:** The terms listed below shall have the following meanings assigned to them throughout and for the purpose of this Solicitation. Additional definitions can be found in Section 2 of the General Terms and Conditions.
 - 2.1 **“AASHTO”** - The American Association of State Highway and Transportation Officials is a standard setting body which publishes specifications, test protocols, and guidelines that are used in highway design and construction throughout the United States. Reference: www.transportation.org.

 - 2.2 **“ADO” and “Agency Delivery Order”** - A written order entered by WVDOH personnel in the wvOASIS financial system against a master agreement, authorizing quantities of commodities and/or services to be delivered in accordance with all terms, conditions, and prices stipulated in the original contract.

 - 2.3 **“Approved Source,” “Approved Plant,” “Approved Product,” or “Approved Vendor”** - terms referring to the Approved Product Lists (APL) of certified manufacturers and/or products that meet acceptable levels of quality as determined by WVDOH Materials Control, Soils and Testing Division (MCS&T). These lists are updated periodically, and it is the Vendors responsibility to refer to the MCS&T website to ensure compliance. Reference: https://transportation.wv.gov/highways/mcst/Pages/APL_By_Number.aspx.

 - 2.4 **“Asphalt,” “Hot Mix Asphalt” and “HMA”** - Terms used interchangeably for asphalt.

 - 2.5 **“Contract Item”** - The list of items available for Vendor to provide pricing as identified in Section 3.2 of this Solicitation and referenced throughout.

 - 2.6 **“Emergency Work”** – Work or orders required to be done without delay owing to circumstances for which the WVDOH could not have reasonably expected and has been designated as such by a representative of the WVDOH.

REQUEST FOR QUOTATION
Ditch, Pipe, and Asphalt Repair and Maintenance by the Vendor

- 2.7 **“EPA”** - Environmental Protection Agency and the WV Department of Environmental Protection and references the Federal, State, and Local levels of government. www.epa.gov and www.dep.wv.gov.
- 2.8 **“Exhibit 1” and “EXH 1”** – Standard Details relevant to work under this contract. Details are excerpts of the West Virginia Division of Highways Engineering Division Typical Sections and Related Details, 2019 edition.
- 2.9 **“FOB” or “Free on Board”** - Indicates that the price for goods includes delivery at the Vendor’s expense to a specified point, and that the Vendor retains liability for loss or damage until the goods are delivered.
- 2.10 **“Liquidated Damages”** - Monetary compensation due from the Vendor in the event the Vendor’s performance falls short of contractual stipulation or breaches the contract. Delays in the delivery of goods and/or services or quality failures or corrections by the Vendor may result in the Agency assessing charges for such deficiencies per these contract Specifications, the Standard Specs Section 108.7, as amended, and calculated from the table posted in Section 6.4.1 of these Specifications.
- 2.11 **“MCS&T”** - The WVDOH Materials Control, Soil and Testing Division, who perform all procedures necessary with sampling, testing, reporting and inspection of products and materials to maintain a reliable quality assurance system. Reference: <http://www.transportation.wv.gov/highways/mcst/Pages/default.aspx>.
- 2.12 **“MP”** - Material Procedures, as amended, issued by the WVDOH Materials Control, Soils and Testing Division. The MP numbers referenced throughout these Contract Specifications are available by MP number at: <https://transportation.wv.gov/highways/mcst/Pages/WVDOH-Materials-Procedures.aspx>
- 2.13 **“Pricing Pages,” “Attachment A,” and “ATT A”** - The schedule of prices attached hereto as Attachment A (ATT A) and used to evaluate Solicitation responses.
- 2.14 **“Solicitation”** - The official notice of an opportunity to supply the State with goods or services.
- 2.15 **“Standard Specs”** - Used throughout this solicitation means the West Virginia Department of Transportation, Division of Highways Standard Specifications, Roads and Bridges, most recent edition, as modified or amended by all subsequent Supplemental Specifications.

REQUEST FOR QUOTATION
Ditch, Pipe, and Asphalt Repair and Maintenance by the Vendor

- 2.16 “Vendor” or “Contractor”**- Interchangeably used throughout this Solicitation and in any cited Sections of the West Virginia Department of Transportation, Division of Highways Standard Specifications, Roads and Bridges, adopted latest Standard Specs edition, as amended, including any Supplementals and refers to any entity submitting a bid in response to the Solicitation, the entity that has been selected as the lowest responsible bidder, or the entity that has been awarded the Contract, as context requires.
- 2.17 “WVDOH” or “Agency”** - Interchangeable terms for the West Virginia Division of Highways.

3. GENERAL REQUIREMENTS:

- 3.1 Standard Specifications Roads and Bridges:** The following Standard Specs Sections shall apply, as applicable, to the administration of this contract: 101, 102, 103, 104, 105, 106, 107, 108, 109, and 110, as amended.

Materials, equipment, and performance of this contract shall conform to, but are not limited to, the requirements of Sections 207, 211, 219, 229, 240, 307, 401, 408, 507, 604 and 636, as amended.

Free electronic copies of the Standard Specs and Supplementals are available at: <https://transportation.wv.gov/highways/TechnicalSupport/specifications/Pages/default.aspx>. Hard copies of these publications may be purchased from the Technical Support Division by completing the Specification Order Form provided within the website.

- 3.2 Contract Items and Mandatory Requirements:** Vendor shall provide Agency with the Contract Items listed below on an open-end and continuing basis. Contract Items are listed on the Pricing Pages which hereafter shall be referred to as “ATT A.” Contract Items must meet or exceed the mandatory requirements as shown below.

The project start date and completion date should be noted on the ADO. Prior to the beginning of any work, the Vendor shall contact Miss Utility of WV via the WV811 app or by dialing 811 at least two business days prior to the ADO’s project start date to allow the utility to identify and mark their facilities. A reference number will be provided to the Vendor to serve as proof of the contact. The Vendor shall retain this reference number with the ADO for possible future need or justification.

Guardrails are the responsibility of WVDOH. WVDOH forces shall perform any guardrail removal, repair, or replacement work needed at project sites. Erosion Control will be the responsibility of WVDOH.

REQUEST FOR QUOTATION
Ditch, Pipe, and Asphalt Repair and Maintenance by the Vendor

3.2.1 Traffic Control, Contract Items 1 thru 4. While undergoing improvement, the project site shall be kept open to traffic in such condition that both local and through traffic will be adequately and safely accommodated. All improvement operations shall be scheduled by the Vendor to keep traffic delay to a minimum.

3.2.1.1 Vendor shall provide traffic control for all projects covered by this contract, unless otherwise instructed by the WVDOH Engineer. Traffic shall be maintained by the Vendor in accordance with Standard Specs Section 636. All traffic control devices shall be fabricated and installed according to the "Manual on Temporary Traffic Control for Streets and Highways", latest version, published by the Agency at <https://transportation.wv.gov/highways/traffic/Documents/TemporaryTrafficControlManual2006.pdf>. The type of construction operation being performed will dictate the traffic control case (scheme) to be used as outlined in this manual and as called for on the Plans. The Vendor shall submit their Traffic Control Plans to the WVDOH Engineer or their designee with their written Project Acceptance/ ADO Acknowledgement, as required in section 6.1 of these Contract Specifications. Vendors Traffic Control Plans are subject to WVDOH approval.

3.2.1.2 The cost for Bridging/Plating material used to maintain traffic at the end of a work shift shall be incidental to the project and shall be at no additional cost to the WVDOH.

3.2.1.3 The roadway shall be free of dirt, debris, and excessive dust and opened to the traveling public at the end of each shift with no additional cost to the WVDOH.

3.2.1.4 If the vendor performs a combination of services under this contract at the same project location, on the same day, they may only charge for traffic control services once.

3.2.2 Ditching Maintenance & Repair, Contract Items 5 thru 14, shall be used for trimming, sloping and cleaning to open all inlets and outlets identified on an ADO. Work shall be carried out in accordance with Standard Specs 207, 211, and 229.

Ditches shall be inspected for damage prior to the start of work. If damage is discovered, this shall be reported to the WVDOH District Engineer or designee for further instructions. Ditches shall be cleared of

REQUEST FOR QUOTATION
Ditch, Pipe, and Asphalt Repair and Maintenance by the Vendor

all obstructions, such as, but not limited to, trees, branches, and boulders, to allow the ditch flowline of water to be led to a suitable place of discharge.

All debris/obstacles removed from a ditch shall be disposed of by the Vendor in accordance with EPA waste disposal laws and regulations. Debris/obstacles that can be recycled/mulched/crushed may only be used to complete the project with the prior approval by the WVDOH District Engineer or designee.

All labor, equipment and material to complete ditching work shall be included in the unit bid prices. Any traffic control required shall be charged per Section 3.2.1 of these Contract Specifications. Acceptance Criteria shall be per Section 3.2.6.

3.2.2.1 Ditching, Contract Item 5, shall meet the depth and width requirements of the Standard Detail for Shoulder and Ditches, EXH 1, Page 1, as directed by the Delivery Order and the WVDOH District Engineer or designee and shall be bid per shoulder mile.

3.2.2.2 Correcting Deep Ditches, Contract Item 6, shall meet the Rock Borrow Excavation requirements of the Standard Detail for Correcting Deep Ditches, EXH 1, Page 2, or as directed by the Delivery Order and the WVDOH District Engineer or designee and shall be bid per ton.

3.2.2.3 Restoring Shoulders, Contract Item 7, shall meet the requirements of the Standard Detail for Restoring Shoulders for Guardrail & Sliver Fills, EXH 1, Page 3, or as directed by the Delivery Order and the WVDOH District Engineer or designee and shall be bid per ton.

3.2.2.4 Shoulder Stone Placement, Contract Item 8, shall meet the requirements of the Standard Detail for Shoulder Reconstruction, EXH 1, Page 4, or as directed by the Delivery Order and the WVDOH District Engineer or designee and shall be bid per ton.

3.2.2.5 Ditching Haul of Materials by Vendor, Contract Items 9 & 10, will only be requested in combination with other awarded ditching items. The WVDOH Engineer or their designee shall calculate mileage distance utilizing "Google Maps" or a similar source for routing from the Vendor's nearest Base of Operations location, as identified on ATT A, to the mid-point of the Agency's project site.

REQUEST FOR QUOTATION
Ditch, Pipe, and Asphalt Repair and Maintenance by the Vendor

The Agency, at its own discretion, will determine the route to be taken due to bridge and/or road restrictions which shall have acceptable load limits for both roads and bridges.

3.2.2.6 Waste Haul for Ditching, Contract Item 11, shall be used for the hauling of/disposal of debris and any material unsuitable for backfill from the project site to a WVDOH approved waste location. This location shall be within proximity to the project site and will be provided on the ADO. The Vendor shall bid an hourly rate per truck/driver.

3.2.3 Pipe Repair & Replacement, Contract Items 15 thru 32. Repair & replacement pipe shall be installed to match the existing inlet and outlet invert elevations unless otherwise directed by the WVDOH District Engineer or designee. The minimum and maximum depth of cover shall be as per the manufacturer's recommendation and shall be no less than 12 inches, unless specified otherwise by the WVDOH Engineer or their designee on the ADO. Work shall be carried out in accordance with Standard Specs 207, and 604. The vendor shall be responsible for the removal and proper disposal of old pipe at no additional charge.

Prior to the issuance of a Delivery Order for Pipe Repair/Replacement, the WVDOH District Engineer or designee shall have all required Environmental Permits in place. The WVDOH shall provide the pipe and pipe hardware required for project. The ADO will indicate whether the Vendor or the WVDOH is responsible for picking up pipe materials and transporting them to the project site. Pick Up of project materials from WVDOH shall be incidental to mobilization. Erosion Control will be the responsibility of the WVDOH. Any traffic control required shall be charged per Section 3.2.1 of these Contract Specifications. Acceptance Criteria shall be per Section 3.2.6.

3.2.3.1 Pipe Repair and Replacement, Contract Items 15 thru 23, shall include all labor, equipment, and materials, excluding pipe and pipe hardware and backfill material, excluding CLSM for F Trenches, in the unit bid price. Bid price shall be per linear foot.

Pipe Repair & Replacement shall meet the requirements of the Standard Detail for Repaving Pipe Trenches F, EXH 1, Page 5, or as identified by the Delivery Order or the WVDOH District Engineer or designee and shall be bid per linear foot.

3.2.3.2 Pipe Repair/Replacement Backfill for F Trench, Contract Item 24, for shall bid CLSM backfill by the cubic yard. The cost of

REQUEST FOR QUOTATION
Ditch, Pipe, and Asphalt Repair and Maintenance by the Vendor

materials per cubic yard shall include haul up to five (5) miles within the bid price.

When replacing gravel surfaces, Type F Trench backfill shall be no less than 12 inches below the surface.

3.2.3.3 Additional Haul of Backfill for F Trench, Contract Item 25: Additional Haul is to be charged for distances exceeding five (5) miles and is to only be used with Contract Item 24. Haul shall be one way and measured per loaded mile from Vendor's source plant to the WVDOH project site, for the portion of the haul which exceeds five (5) miles. Vendor shall use suitable routes selected by the Agency District Engineer. All such chosen routes shall have acceptable load limits for both roads and bridges.

3.2.3.4 Safe Access and Egress Surcharge, Contract Items 26-28. To meet OSHA standards required for trenching, sloping, shoring, use of shielding protections or other types of supports to prevent soil cave-ins, after a depth of 4-foot, the Vendor may add a surcharge to the project. If the WVDOH District Engineer or designee did not include this surcharge in their initial estimated cost for the project, the Vendor shall advise the WVDOH District Engineer or designee as soon as possible. The WVDOH District Engineer or designee may agree or disagree with the Vendor's request; the decision of the District Engineer shall be final.

3.2.3.5 Waste Haul for Pipe Repair/Replacement, Contract Item 29, shall be used for the hauling of/disposal of debris and any material unsuitable for backfill from the project site to a WVDOH approved waste location. This location shall be within proximity to the project site and will be provided on the Delivery Order. The Vendor shall bid an hourly rate per truck/driver.

3.2.4 Asphalt Pavement Repair, Contract Items 33 thru 56: Pothole Repair, Base Failure Repair, or Edge Failure Repair shall be requested to correct potholes, edge failures, upheavals, settlements, cracking, raveling and base failures to prevent further deterioration, eliminate safety hazards, improve riding quality and restore proper drainage as identified on an ADO.

Repairing an existing pavement shall consist of squaring up the repair area, removing damaged material to a depth, per the Standard Detail, directed by the WVDOH District Engineer or designee, cleaning, hauling and disposing of existing pavement, tacking of existing surfaces and placing and compacting Asphalt Base II in lifts not exceeding two (2")

REQUEST FOR QUOTATION
Ditch, Pipe, and Asphalt Repair and Maintenance by the Vendor

inches to the level of the existing pavement. Asphalt Base II is to be used for work under this contract, in accordance with Standard Spec 401, or as approved by the WVDOH Engineer. **Asphalt shall be sourced from an MCS&T Approved Asphalt Plant, and stone or crushed aggregate shall be sourced from an MCS&T Approved Material Source.** Tack Coat shall be carried out in accordance with Standard Specs 408 and Pothole Repair on concrete pavement shall be carried out in accordance with Standard Specs 507. Milling for Asphalt Repair Contract Items will be incidental to the work, and not charged for separately.

Any traffic control required shall be charged per Section 3.2.1 of the Contract Specifications. Acceptance Criteria shall be per Section 3.2.6.

Quality control at the plant and in-the-field shall be the responsibility of the Vendor and shall meet the requirements of MP 401.03.50. Compaction quality control shall be in accordance with Section 401 of the Standard Specs. Acceptance testing for compaction shall be the responsibility of the WVDOH. Quality control and Verification testing of the material shall be as set forth in MP 401.02.27 for Marshall Mix designs.

There will be no fuel, binder or other price adjustment to the asphalt used for Asphalt Pavement Repair.

3.2.4.1 Pothole Repair, Contract Items 33 thru 36, shall include all labor, equipment, and materials to complete Pothole Repair, according to EXH 1, Page 6, The Vendor shall bid per the four (4) quantity tiers (0-50, 51-250, 251-500, and 501+) units of square yard, per each mile, as shown on ATT A.

NOTE: To calculate for Asphalt Pothole Repair Pricing, Asphalt repair shall be a depth of two-inch (2") vertical increments. The span by width and length shall be measured by the total number of square yards, per mile. Each two-inch increment would be multiplied by the number of square yards and per mile. Unit quantities would increase for every two-inch (2") increment, and again, per tier.

3.2.4.2 Base Failure Repair, Asphalt, Contract Items 37 thru 40, shall use Asphalt Base II, and shall be bid per the four (4) quantity tiers (0-50, 51-250, 251-500, and 501+) units of square yards, per each mile, as shown on ATT A. Base Failure bids shall include all labor, equipment, and materials to complete Base Failure Repair, according to EXHIBIT 1, Page 7, or as specified by the WVDOH District Engineer or their designee.

REQUEST FOR QUOTATION
Ditch, Pipe, and Asphalt Repair and Maintenance by the Vendor

3.2.4.3 Base Failure Repair, Stone, Contract Items 41 thru 44, shall be bid per the four (4) quantity tier (0-50, 51-250, 251-500, and 501+) units of square yards, per each mile, as shown on ATT A. Base Failure bids shall include all labor, equipment, and materials to complete Base Failure Repair, according to EXHIBIT 1, Page 7, or as specified by the WVDOH District Engineer or their designee.

NOTE: Per EXHIBIT 1, Page 7, “Varies*” shall mean for every 3 inches of asphalt, there shall be 6 inches of stone, unless specified otherwise by the Engineer.

3.2.4.4 Edge Failure Repair, Contract Items 45 thru 48, shall include all labor, equipment, and materials to complete Edge Failure Repair according to EXHIBIT 1, Page 8. The Vendor shall bid per the four (4) quantity tier (0-50, 51-250, 251-500, and 501+) units of square yards, per each mile, as shown on ATT A.

3.2.4.5 Haul by Vendor for Asphalt Pavement Repair, Contract Items 49 & 50, will only be requested in combination with other awarded Asphalt Pavement Repair items. The WVDOH Engineer or their designee shall calculate mileage distance utilizing “Google Maps” or a similar source for routing from the Asphalt Plant location to the mid-point of the Agency’s project site. The Agency, at its own discretion, will determine the route to be taken due to bridge and/or road restrictions which shall have acceptable load limits for both roads and bridges.

3.2.4.6 Waste Haul for Asphalt Pavement Repair, Contract Item 51, shall be used for the hauling of/disposal of debris and any material unsuitable for backfill from the project site to a WVDOH approved waste location. This location shall be within proximity to the project site and will be provided on the ADO. The Vendor shall bid an hourly rate per truck/driver.

3.2.4.7 Off-Season Plant Opening, Contract Items 52 & 53: If the Vendor is required to open his plant in the off-season to service the needs of the WVDOH, an additional payment will be made. The Vendor will be paid an additional day charge for each additional consecutive day that the plant is open after the first day to service the needs of the WVDOH. If the plant produces no material for any use on any calendar day, either during the week or on the weekend, the WVDOH will pay the first day rate for off-season plant opening on the next day of the WVDOH usage.

REQUEST FOR QUOTATION
Ditch, Pipe, and Asphalt Repair and Maintenance by the Vendor

3.2.4.7.1 Payment for this item can only be authorized and made during the winter months, i.e., between December 15th and March 15th, and then only if the plant would not have otherwise been open. These dates may be revised by the WVDOH District Engineer or their designee, if necessary, to meet specific needs in the field. Any such revision of dates will be in writing and shall be attached to the Vendor's invoice at the time payment is requested.

3.2.4.7.2 Payment will always be made at the full contract awarded bid price for the first day of plant opening; however, the amount paid from each additional day of plant opening will be reduced as follows:

- A.** Payment for additional day charge will not be made if the plant has produced over 500 tons on that day. If between 300 and 500 tons have been produced, payment for additional day charge will be made equal to one-half of the contract awarded bid price for the additional day charge. The quantity produced to make this determination shall include all material produced that day, which includes tonnage bought by the WVDOH, other local governments and all private work.
- B.** The WVDOH will only pay its share of the amount determined to be due for additional day charge as described above. For example, if the plant produces 375 tons and the WVDOH takes 150 tons of the total, 40% of the plant's daily production, payment for additional day charge would be calculated as follows: Since the total daily production is between 300 and 500 tons, the Vendor is due 50% of the additional day charge. Because the WVDOH's share of this daily production is 40%, the WVDOH would pay 40% of one-half of the additional day charge, or in this case, 20% of the additional day charges.

3.2.4.7.3 A certified statement shall accompany the invoice stating the total quantity produced on the additional day. If payment does not qualify due to tonnage produced, the next consecutive day of plant operation, if any, will

REQUEST FOR QUOTATION
Ditch, Pipe, and Asphalt Repair and Maintenance by the Vendor

qualify for payment at the additional day rate rather than the first day rate for plant opening.

3.2.5 Mobilization, Contract Items 12-14, 30-32, and 54-56, includes all operations required to move personnel, equipment, supplies and incidentals to a project site. Only one mobilization for category of work (ditching, pipe repair, or asphalt pavement repair) per day of operation will be paid, unless moves of over five (5) miles between individual project locations are required. In cases where a Vendor is required to move from one roadway to the adjacent roadway of a divided highway, additional mobilization for Ditching will only be paid if the nearest interchange or crossing point that will accommodate the Vendor's equipment is over five (5) miles from the project locations.

NOTE: This provision may require roundtrip moves of up to ten (10) miles with no additional mobilization per project payment. An individual project location shall be defined as a project where no skips exceeding 1,000 feet are involved, except between the approach slabs of a bridge or parallel pair of bridges.

3.2.5.1 Daytime Mobilization is a daytime mobilization charge that will be charged per County within a WVDOH District. The Vendor may bid any or all Counties within a WVDOH District. The Vendor shall bid a lump sum cost for mobilization per County.

3.2.5.2 Nighttime Mobilization is a nighttime mobilization charge that will be charged per County within a WVDOH District. The Vendor may bid any or all Counties within a WVDOH District. The Vendor shall bid a lump sum cost for mobilization per County.

3.2.5.3 On-Site Mobilization shall be non-production moves within a project over 1,000 feet, as authorized by the WVDOH District Engineer or their designee. The Vendor shall bid a lump sum.

3.2.5.4 Multiple Mobilizations: If the vendor performs a combination of services under this contract at the same project location, on the same day, they may only charge one mobilization, using the higher mobilization rate bid for either service.

3.2.6 Project Acceptance Criteria: It is the expectation of the WVDOH that the Vendor completes each job in the best possible reasonable timeframe in a professional manner, by competent, trained, experienced, and qualified personnel, while meeting all requirements of the project, prior to the completion date provided by the WVDOH District Engineer or their designee. A daily visual inspection by the WVDOH District Engineer or

REQUEST FOR QUOTATION
Ditch, Pipe, and Asphalt Repair and Maintenance by the Vendor

designee shall be assessed of the project work. The WVDOH reserves the right to dictate the performance of this contract's work and may evaluate materials, methods, and shall have final decision to determine if work is acceptable or complete. Work found not in compliance with the requirements of this contract may be required to be reworked at the Vendor's expense until acceptable by the WVDOH District Engineer or designee. The WVDOH District Engineer or their designee will include a start date and a completion date on the ADO.

Upon completion of the project, the WVDOH District Engineer or designee shall approve the project as acceptable and complete.

- 3.2.7 Emergency Work:** Emergency work as ordered by WVDOH District Engineer, or their designee is work that shall be initiated within forty-eight (48) hours from when the request is received by the vendor. The determination of emergency work will be in accordance with Section 2.6 of this Solicitation and prominently noted on ADO. Designated emergency projects will be paid at 1.50 times the vendors bid price.

4. CONTRACT AWARD:

- 4.1.1 Contract Award:** The contract is intended to provide agencies with a purchase price on all Contract Items. All qualified responsible Vendors shall be awarded a contract for those Contract Items bid which meet all mandatory requirements of this Contract. Vendors do not have to bid all categories of work (Ditching Maintenance & Repair, Pipe Repair & Replacement, or Asphalt Pavement Repair) to be awarded a contract, however they must bid all Traffic Control Contract Items (Part I on ATT A) and all Contract Items within the category of work they are bidding. Vendors may bid any or all categories of work. **Failure to submit bid with Traffic Control and the category of work Contract Items bid in their entirety will result in the disqualification of the bid for the affected category of work.**
- 4.1.2 Determining Low Bid Per Project:** To determine the low bid vendor for individual projects, the WVDOH District Engineer or their designee will calculate the lowest overall total cost of the Contract Items required for individual projects. A written ADO will be issued to the Vendor with the lowest overall total cost.

WVDOH reserves the right to request any one or combination of Contract Items for which bids are awarded at the lowest overall total as set forth in this section.

REQUEST FOR QUOTATION
Ditch, Pipe, and Asphalt Repair and Maintenance by the Vendor

- 4.2 Pricing Pages, Attachment A (“ATT A”):** Vendor shall complete the Pricing Pages by providing a bid price for each Contract Item listed. Vendor shall factor into their bid prices all equipment, materials, delivery, and labor required to provide Contract Items. Vendors may bid on any or all Districts. Vendor shall complete the Pricing Pages for each Contract Item bid in their entirety as failure to do so may result in Vendor’s bids being disqualified. All bids or pricing submitted shall be held and honored by the Vendor for 90 days after the bid opening date.

Vendors may bid projects in any or all Counties. Counties bid with identical pricing can be submitted on one Pricing Page (ATT A) set. If prices vary from county/set of counties, vendor should submit ATT A for each pricing set.

- 4.2.1** The Pricing Pages contain a list of the Contract Items with no guarantee that any Contract Item will be purchased throughout the life of this contract. Estimated quantities are not available.
- 4.2.2** Vendors bidding Ditching Maintenance & Repair must bid Part I - Traffic Control on ATT A as well as all Contract Items listed in Part II - Ditching Maintenance & Repair on ATT A in their entirety.
- 4.2.3** Vendors bidding Pipe Repair & Replacement must bid Part I - Traffic Control on ATT A as well as all Contract Items listed in Part III - Pipe Repair & Replacement on ATT A in their entirety.
- 4.2.4** Vendors bidding Asphalt Pavement Repair must bid Part I - Traffic Control on ATT A as well as all Contract Items listed in Part IV - Asphalt Pavement Repair on ATT A in their entirety.
- 4.2.5** Failure to submit bid with Traffic Control and the category of work (Part II, III, or IV on ATT A) in its entirety will result in the disqualification of the bid, for the category of work bid.
- 4.2.6** Failure to provide Base of Operations information on ATT A will result in the disqualification of the entire bid.
- 4.2.7** Vendor should type or electronically enter the information into the Pricing Pages spreadsheet to prevent errors in the evaluation. In most cases, the Pricing Pages are available in wvOASIS within the solicitation attachments, however, Vendors may request an electronic copy of the Pricing Pages spreadsheet for bid purposes by sending an email request to the following address: DOTProcurement@wv.gov.
- 4.2.8** Changing a column or row description, Contract Item description, or unit of measure on the **Pricing Pages, Attachment A (ATT A)**, shall result in

REQUEST FOR QUOTATION
Ditch, Pipe, and Asphalt Repair and Maintenance by the Vendor

disqualification of the Contract Item bid on the altered line. In circumstances when all Contract Items must be bid for bid evaluation and contract award, the disqualification of any Contract Item will result in the disqualification of the entire bid.

Submitting Pricing Pages other than those provided with this solicitation, as described in Section 4.2 shall result in the disqualification Vendor's bid in its entirety.

Vendor entries of bid prices or other notations made in wvOASIS commodity line descriptions will not be considered for bid evaluation or award.

- 4.3 Contract Award Transition:** Upon award of this contract, the WVDOH Operations Division will announce the effective date of use of this contract to the Districts and the Vendors, whether it is by the effective date, the completed and encumbered date, or an established date by the WVDOH. Upon the announced effective date of use, any order issued prior to the award of the contract shall remain in effect and should not be cancelled until that order is filled; however, after 10 working days of the Districts and Vendors notice, any order that has not been completely filled by the Vendors shall NOT be completed and a cancellation notice will be sent to that Vendor from the issuing District for cancellation of the balance of that order only. No orders from prior contracts should be held open by the Districts or Vendors longer than 10 working days after the effective date of use is announced for the new contract.

5. ORDERING AND PAYMENT:

- 5.1 Ordering:** Vendor shall accept orders through regular mail, facsimile, email, or any other written forms of communication. Vendor shall maintain and keep current its phone numbers, fax number, email address, locations, and ordering/billing/payment addresses with WVDOH and in wvOASIS. Vendor may, but is not required to, accept online orders through a secure internet ordering portal/website. If Vendor can accept online orders, it shall include in its response a brief description of how Agencies may utilize the online ordering system. Vendor shall ensure that its online ordering system is properly secured prior to processing Agency orders online.
- 5.2 Agency Delivery Order ("ADO"):** District personnel must issue an ADO from wvOASIS for specific quantities of materials based on each project's requirements and detailing the need and location information of work to be completed per Contract Items, as well as the start and end dates, which will become the agreed upon official start and end dates. The ADO must be created in wvOASIS and approved to "Final", prior to placing the order with the Vendor. The District is

REQUEST FOR QUOTATION
Ditch, Pipe, and Asphalt Repair and Maintenance by the Vendor

responsible for creating the ADO in OASIS and is required to submit the approved order, in writing, directly to the vendor via mail, email or fax. **Verbal communication with the Vendor is not considered an official order.** In the event the Vendor denies an order or if there are changes to an ADO, the District must process a change order to the approved ADO issued from wvOASIS.

Emergencies shall be prominently noted on the ADO. Once complete, the ADO shall be sent to Vendor via fax, email, or mail.

5.2.1 Lead Time: The WVDOH should plan accordingly to allow the Contractor a minimum of 14 calendar days prior to the date of the agreed upon start date on the ADO to allow Vendor to mobilize and begin work.

5.3 Payment: Upon completion of the work indicated on the ADO, Vendor shall accept payment in accordance with the payment procedures of the State of West Virginia. The State of West Virginia currently utilizes a Purchasing Card program, administered under contract by a banking institution, as well as Electronic Funds Transfer as methods to process payment for goods and services. The Vendor shall accept the State of West Virginia's Purchasing Card and Electronic Funds Transfer for payment of orders under this Contract. Electronic Funds Transfer for payment is available through the WV State Auditor's Office. The Vendor may visit the WV State Auditor's website (wvsao.gov) for all necessary forms and instructions. Payment method may be dictated at WVDOH's discretion.

6. PROJECT ACCEPTANCE, DELIVERY AND RETURN:

6.1 Project Acceptance and Written Verification of Receipt: Upon receipt of a WVDOH ADO, the Vendor shall advise the WVDOH in writing within five (5) calendar days of their acceptance or refusal of the ADO. As verification of receipt, Vendor must provide written acknowledgement of any ADO and any Revisions/Modifications thereto sent by WVDOH. Failure to provide the WVDOH with written acknowledgement of any ADOs/Revisions within five (5) days of the Order being sent shall be considered refusal of the ADO. In the event of refusal, the WVDOH at its own discretion shall cancel the ADO and may seek to obtain the goods or services from the next low bid Vendor or proceed with an emergency purchase from the open market.

6.1.1 Negotiation of Dates: The WVDOH shall have the option to negotiate with the Vendor, the project's tentative start and end dates. **Project work shall be continuous to completion unless otherwise approved in writing by the WVDOH District Engineer or their designee.**

6.2 Delivery Time: In accordance with Section 6.1 and the terms of this contract, the

REQUEST FOR QUOTATION
Ditch, Pipe, and Asphalt Repair and Maintenance by the Vendor

work shall be scheduled by the WVDOH. The Vendor shall mobilize, commence, and complete work delivery in accordance with the WVDOH's written ADO, per project. Any changes must be communicated by the Vendor in writing to the WVDOH District Engineer or their designee. The Vendor shall work in an efficient manner in effort to keep traffic delay to a minimum and traffic must be adequately and safely accommodated. Vendor shall ship/provide all orders in accordance with the dates assigned to each project per the ADO and shall not hold orders until a minimum delivery quantity is met. **No Vendor is authorized to ship project related goods or begin work/services, nor is the WVDOH authorized to receive materials, prior to the issuance of an ADO.**

6.3 Adverse Weather Conditions: Unsuitable/adverse/inclement weather conditions may dictate the work schedule. It is preferred that operations be suspended immediately when an inclement weather event begins or if the WVDOH District Engineer or their designee determines that an inclement weather event is imminent. If working conditions are dangerous or unsuitable for the WVDOH, Vendor, or general public, work shall be suspended by the WVDOH Engineer/designee. If needed, revision to the project's start and end date may be negotiated by the Vendor and the WVDOH Engineer/designee. After a weather-related suspension of work, the WVDOH District Engineer or their designee shall determine and convey in writing, such ADO changes and when work shall commence/resume, followed by the Vendor's written acknowledgement, per Section 6.4 of this Contract Solicitation.

6.4 Late Delivery: The Agency placing the order under this Contract must be notified in writing if orders will be delayed for any reason. Any delay in delivery that could cause harm to an Agency will be grounds for cancellation of the delayed order, and/or obtaining the items ordered from another awarded vendor or proceed with an Emergency Purchase from the open market.

The Agency placing the ADO under this Contract must be notified **in writing by the Vendor no later than five (5) business days prior to the scheduled start date noted on the Agency's order.** Any failure to notify, acknowledge receipt of WVDOH's written ADOs/ Revisions resulting in delivery delay, or failure to start or complete the project per the WVDOH scheduled due dates may be determined by the WVDOH at its sole discretion as harmful to the Agency and as such, shall result in WVDOH's cancellation of the ADO and application of Liquidated Damages.

Any Agency seeking to obtain items from the open market under this provision must first obtain approval of the WVDOH Budget & Procurement Division.

6.4.1 Liquidated Damages: If the Vendor's work completion or corrections of deficient work exceeds the ADO completion due date or timeframe, the Vendor shall agree that no extension of contract time will be granted

REQUEST FOR QUOTATION
Ditch, Pipe, and Asphalt Repair and Maintenance by the Vendor

unless Liquidated Damages are applied by the WVDOH in the form of an off-set reduction to the total amount of the Vendor's final invoice. The WVDOH shall calculate Liquidated Damages per project beginning on day one (1) after the WVDOH's specified ADO due date and in accordance with this Section, the Contract's Terms and Conditions, Standard Specs Section 108.7, and the following Standard Specs Section Table 108.7.1 - Schedule of Liquidated Damages, as amended:

**Table 108.7.1
 Schedule of Liquidated Damages**

Original Contract Amount		Daily Charges Per Calendar Day
For More Than	To and Including	
\$0	\$500,000	\$350
\$500,000	\$2,000,000	\$650
\$2,000,000	\$10,000,000	\$1,600
\$10,000,000	\$25,000,000	\$3,100
\$25,000,000		\$4,200

6.4.2 Force Majeure: It shall be further noted that the Vendor is not responsible for and shall not be penalized for delays in its delivery of goods and/or services when caused by factors or events outside Vendor's control, including but not limited to acts or omissions of the Agency or third parties, acts of civil or military authority, civil disturbance, war, terrorism, pandemics, explosions, fire, floods, tornadoes, or other natural disasters or acts of God.

6.5 Delivery Payment/Risk of Loss: Standard order delivery shall be F.O.B. destination to the Agency's location. Vendor shall include the cost/discount of standard order delivery charges in its bid pricing and is not permitted to charge the Agency separately for such delivery. The Agency will pay delivery charges on all emergency orders provided that Vendor invoices those delivery costs as a separate charge with the original freight bill attached to the invoice.

Deliveries made by the vendor shall be comprised only of Contract Items intended for delivery at that location and specified in the pricing pages, contract specifications or ADO. At no time shall property belonging to the West Virginia Department of Transportation be utilized as a lay-down or storage facility by the vendor, or items left with the intention of being distributed to an alternate location.

6.6 Project Acceptance Criteria: The WVDOH District Engineer or their designee shall have final acceptance of the work done by the Vendor, per project. Any work found by the WVDOH District Engineer or their designee not performed in accordance with these contract specifications or the Standard Specs, as amended, and/or found deficient and unacceptable by visual inspection will be rejected and,

REQUEST FOR QUOTATION
Ditch, Pipe, and Asphalt Repair and Maintenance by the Vendor

at the Vendor's/Contractor's expense, will be removed and replaced by the Vendor with work being continual until the Vendor's deficient work corrections are completed and deemed acceptable and approved by the WVDOH District Engineer or their designee. Under no circumstance shall the Vendor's deficiency corrections exceed twenty (20) calendar days unless otherwise declared in writing by the WVDOH District Engineer or their designee and may be subject to Liquidated Damages as per Section 6.5.1 of these Contract Specifications.

- 6.7 Return of Unacceptable Items:** The decision of the WVDOH District Engineer or their designee regarding materials, workmanship, quality etc., shall be final per the Standard Specs Section 105.1, as amended. If the Agency deems the Contract Items to be unacceptable, the Contract Items shall be returned to Vendor at Vendor's expense and with no restocking charge. Vendor shall either arrange for the return within five (5) days of being notified that items are unacceptable or permit the Agency to arrange for the return and reimburse Agency for delivery expenses. If the original packaging cannot be utilized for the return, Vendor will supply the Agency with appropriate return packaging upon request. All returns of unacceptable items shall be F.O.B. the Agency's location. The returned product shall either be replaced, or the Agency shall receive a full credit or refund for the purchase price, at the Agency's discretion.
- 6.8 Return Due to Agency Error:** Items ordered in error by the Agency will be returned for credit within 30 days of receipt, F.O.B. Vendor's location. Vendor shall not charge a restocking fee if returned products are in a resalable condition. Items shall be deemed to be in a resalable condition if they are unused and in the original packaging. Any restocking fee for items not in a resalable condition shall be the lower of the Vendor's customary restocking fee or 5% of the total invoiced value of the returned items.

7. VENDOR DEFAULT:

- 7.1** The following shall be considered a vendor default under this Contract.
- 7.1.1** Failure to provide Contract Items in accordance with the requirements contained herein.
 - 7.1.2** Failure to comply with other specifications and requirements contained herein.
 - 7.1.3** Failure to comply with any laws, rules, and ordinances applicable to the Contract Services provided under this Contract.

REQUEST FOR QUOTATION
Ditch, Pipe, and Asphalt Repair and Maintenance by the Vendor

- 7.1.4 Failure to remedy deficient performance upon request.
- 7.2 The following remedies shall be available to Agency upon default.
 - 7.2.1 Immediate cancellation of the Contract.
 - 7.2.2 Immediate cancellation of one or more release orders issued under this Contract.
 - 7.2.3 Any other remedies available in law or equity.

8. MISCELLANEOUS:

- 8.1 **No Substitutions:** Vendor shall supply only Contract Items submitted in response to the Solicitation unless a contract modification is approved in accordance with the provisions contained in this Contract.
- 8.2 **Vendor Supply:** Vendor must carry sufficient inventory of the Contract Items being offered to fulfill its obligations under this Contract. By signing its bid, Vendor certifies that it can supply the Contract Items contained in its bid response.
- 8.3 **Reports:** Vendor shall provide the Agency with quarterly reports, annual summaries, and/or monthly reports as requested by the Agency and/or the West Virginia Purchasing Division showing quantities, total dollar value of the Contract Items purchased, ordered, shipped & invoiced with dates in spreadsheet format as defined by the Agency. Failure to supply such reports may be grounds for cancellation of this Contract.
- 8.4 **Contract Manager:** During its performance of this Contract, Vendor must designate and maintain a primary contract manager responsible for overseeing Vendor's responsibilities under this Contract. The Contract Manager must be available during normal business hours to address any customer service or other issues related to this Contract. Vendor should list its Contract Manager and his or her contact information below.

Contract Manager: David Lash
Telephone Number: 740-296-8009
Fax Number: 724-745-7778
Email Address: dslash@castandbaker.com

Vendor shall inform the Agency in writing of any changes to the information provided above within 10 calendar days of such changes. Failure to comply may be grounds for cancellation of this contract.

ATTACHMENT A PRICING PAGE (ATT A)

Vendor Instructions: Vendor shall provide their name and Base of Operations physical address applicable to ATT A in the spaces below. If the vendor has multiple Base of Operations location addresses, vendor may insert additional lines. Vendor shall then mark with an "X" the counties that correspond with the bid prices on this page. If Vendor has varied pricing per county, Vendor shall complete a separate set of Pricing Pages (ATT A) for each county pricing set. Vendor must bid all Traffic Control Contract Items in Part I below. Vendors may bid any or all categories of work in Part II, Part III, or Part IV below, but must bid all Contract Items within a category of work to be awarded a contract.

This is a multiple vendor award contract. All qualifying vendors meeting the contract specifications will be awarded with a contract. The low bid vendor per project will be determined at the time of need, as per Section 4.1 of the Contract Specifications. Estimated quantities are not available.

VENDOR'S NAME: Cast & Baker Corporation
Vendor's Base of Operations: 2214 Washington Road
 (Please provide physical address): Canonsburg, PA 15317

District 1	District 2	District 3	District 4	District 5	District 6	District 7	District 8	District 9	District 10
<input type="checkbox"/> Boone	<input type="checkbox"/> Cabell	<input type="checkbox"/> Calhoun	<input type="checkbox"/> Doddridge	<input type="checkbox"/> Berkeley	<input checked="" type="checkbox"/> Brooke	<input type="checkbox"/> Barbour	<input type="checkbox"/> Pendleton	<input type="checkbox"/> Fayette	<input type="checkbox"/> McDowell
<input type="checkbox"/> Clay	<input type="checkbox"/> Lincoln	<input type="checkbox"/> Jackson	<input type="checkbox"/> Harrison	<input type="checkbox"/> Grant	<input checked="" type="checkbox"/> Hancock	<input type="checkbox"/> Braxton	<input type="checkbox"/> Pocahontas	<input type="checkbox"/> Greenbrier	<input type="checkbox"/> Mercer
<input type="checkbox"/> Kanawha	<input type="checkbox"/> Logan	<input type="checkbox"/> Pleasants	<input type="checkbox"/> Marion	<input type="checkbox"/> Hampshire	<input checked="" type="checkbox"/> Marshall	<input type="checkbox"/> Gilmer	<input type="checkbox"/> Randolph	<input type="checkbox"/> Monroe	<input type="checkbox"/> Raleigh
<input type="checkbox"/> Mason	<input type="checkbox"/> Mingo	<input type="checkbox"/> Ritchie	<input type="checkbox"/> Monongalia	<input type="checkbox"/> Hardy	<input checked="" type="checkbox"/> Ohio	<input type="checkbox"/> Lewis	<input type="checkbox"/> Tucker	<input type="checkbox"/> Nicholas	<input type="checkbox"/> Wyoming
<input type="checkbox"/> Putnam	<input type="checkbox"/> Wayne	<input type="checkbox"/> Roane	<input type="checkbox"/> Preston	<input type="checkbox"/> Jefferson	<input checked="" type="checkbox"/> Tyler	<input type="checkbox"/> Upshur		<input type="checkbox"/> Summers	
		<input type="checkbox"/> Wirt	<input type="checkbox"/> Taylor	<input type="checkbox"/> Mineral	<input checked="" type="checkbox"/> Wetzel	<input type="checkbox"/> Webster			
		<input type="checkbox"/> Wood		<input type="checkbox"/> Morgan					

Part I - Traffic Control *required

Contract Item #	Contract Item Description	Unit of Measure	List Price
1	Pilot Truck and Driver	Day	\$1,000.00
2	Traffic Control Devices	Unit	\$5.25
3	Flagger	Hour	\$150.00
4	Arrow Board	Day	\$95.00

ATTACHMENT A PRICING PAGE (ATT A)

VENDOR'S NAME: Cast & Baker Corporation

Vendor's Base of Operations: 2214 Washington Road

(Please provide physical address): Canonsburg, PA 15317

District 1	District 2	District 3	District 4	District 5	District 6	District 7	District 8	District 9	District 10
Boone Clay Kanawha Mason Putnam	Cabell Lincoln Logan Mingo Wayne	Calhoun Jackson Pleasants Ritchie Roane Wirt Wood	Doddridge Harrison Marion Monongalia Preston Taylor	Berkeley Grant Hampshire Hardy Jefferson Mineral Morgan	Brooke Hancock Marshall Ohio Tyler Wetzel	Barbour Braxton Gilmer Lewis Upshur Webster	Pendleton Pocahontas Randolph Tucker	Fayette Greenbrier Monroe Nicholas Summers	McDowell Mercer Raleigh Wyoming

Part II - Ditching Maintenance & Repair

Contract Item #	Contract Item Description	Unit of Measure	List Price
5	Ditching	Shoulder Mile	\$20,000.00
6	Correcting Deep Ditches	Ton	\$380.00
7	Restoring Shoulders and Shoulder Stone	Ton	\$460.00
8	Shoulder Stone Placement	Ton	\$300.00
9	Ditching Haul by Vendor for Contract Items 6, 7 & 8, First Ton Mile	Ton Mile	\$7.50
10	Ditching Haul by Vendor for Contract Items 6, 7 & 8, Each Additional Mile	Ton Mile	\$0.75
11	Ditching Waste Haul by Vendor per truck/driver	Hour	\$150.00
12	Daytime Mobilization	Lump Sum	\$2,500.00
13	Nighttime Mobilization	Lump Sum	\$5,000.00
14	On-Site Mobilization	Lump Sum	\$1,000.00

Part III - Pipe Repair & Replacement

Contract Item #	Contract Item Description	Unit of Measure	List Price
15	15" Type F Trench	Linear Foot	\$125.00
16	18" Type F Trench	Linear Foot	\$125.00
17	24" Type F Trench	Linear Foot	\$125.00
18	30" Type F Trench	Linear Foot	\$125.00
19	36" Type F Trench	Linear Foot	\$150.00
20	42" Type F Trench	Linear Foot	\$250.00
21	48" Type F Trench	Linear Foot	\$250.00

VENDOR'S NAME: Cast & Baker Corporation

Vendor's Base of Operations: 2214 Washington Road

(Please provide physical address): Canonsburg, PA 15317

District 1	District 2	District 3	District 4	District 5	District 6	District 7	District 8	District 9	District 10
<input type="checkbox"/> Boone <input type="checkbox"/> Clay <input type="checkbox"/> Kanawha <input type="checkbox"/> Mason <input type="checkbox"/> Putnam	<input type="checkbox"/> Cabell <input type="checkbox"/> Lincoln <input type="checkbox"/> Logan <input type="checkbox"/> Mingo <input type="checkbox"/> Wayne	<input type="checkbox"/> Calhoun <input type="checkbox"/> Jackson <input type="checkbox"/> Pleasants <input type="checkbox"/> Ritchie <input type="checkbox"/> Roane <input type="checkbox"/> Wirt <input type="checkbox"/> Wood	<input type="checkbox"/> Doddridge <input type="checkbox"/> Harrison <input type="checkbox"/> Marion <input type="checkbox"/> Monongalia <input type="checkbox"/> Preston <input type="checkbox"/> Taylor	<input type="checkbox"/> Berkeley <input type="checkbox"/> Grant <input type="checkbox"/> Hampshire <input type="checkbox"/> Hardy <input type="checkbox"/> Jefferson <input type="checkbox"/> Mineral <input type="checkbox"/> Morgan	<input checked="" type="checkbox"/> Brooke <input checked="" type="checkbox"/> Hancock <input checked="" type="checkbox"/> Marshall <input checked="" type="checkbox"/> Ohio <input checked="" type="checkbox"/> Tyler <input checked="" type="checkbox"/> Wetzel	<input type="checkbox"/> Barbour <input type="checkbox"/> Braxton <input type="checkbox"/> Gilmer <input type="checkbox"/> Lewis <input type="checkbox"/> Upshur <input type="checkbox"/> Webster	<input type="checkbox"/> Pendleton <input type="checkbox"/> Pocahontas <input type="checkbox"/> Randolph <input type="checkbox"/> Tucker	<input type="checkbox"/> Fayette <input type="checkbox"/> Greenbrier <input type="checkbox"/> Monroe <input type="checkbox"/> Nicholas <input type="checkbox"/> Summers	<input type="checkbox"/> McDowell <input type="checkbox"/> Mercer <input type="checkbox"/> Raleigh <input type="checkbox"/> Wyoming

22	54" Type F Trench	Linear Foot	\$250.00
----	-------------------	-------------	----------

Contract Item #	Contract Item Description	Unit of Measure	List Price
23	60" Type F Trench	Linear Foot	\$250.00
24	Pipe Repair/Replacement backfill for F Trench (material + delivery first 5 miles)	Cubic Yard	\$475.00
25	Additional Haul per truck load over 5 miles, Backfill for F Trench	Mile	\$9.00
26	Safe Access and Egress Surcharge depth of 5-foot to 10-foot	Lump Sum	\$2,750.00
27	Safe Access and Egress Surcharge depth of 10-foot to 15-foot	Lump Sum	\$5,500.00
28	Safe Access and Egress Surcharge depth 15-foot to 20-foot	Lump Sum	\$6,800.00
29	Pipe Repair/Replacement Waste Haul by Vendor per truck/driver	Hour	\$150.00
30	Daytime Mobilization	Lump Sum	\$2,500.00
31	Nighttime Mobilization	Lump Sum	\$5,000.00
32	On-Site Mobilization	Lump Sum	\$750.00

Part IV - Asphalt Pavement Repair

Contract Item #	Contract Item Description	Size of Project, per Mile	Unit of Measure	List Price
33	Pothole Repair	0-50 SY	Mile	\$11,500.00
34		51-250 SY		\$12,100.00
35		251-500 SY		\$19,500.00
36		501 SY or greater		\$32,500.00

VENDOR'S NAME: Cast & Baker Corporation

Vendor's Base of Operations: 2214 Washington Road

(Please provide physical address): Canonsburg, PA 15317

District 1	District 2	District 3	District 4	District 5	District 6	District 7	District 8	District 9	District 10
<input type="checkbox"/> Boone <input type="checkbox"/> Clay <input type="checkbox"/> Kanawha <input type="checkbox"/> Mason <input type="checkbox"/> Putnam	<input type="checkbox"/> Cabell <input type="checkbox"/> Lincoln <input type="checkbox"/> Logan <input type="checkbox"/> Mingo <input type="checkbox"/> Wayne	<input type="checkbox"/> Calhoun <input type="checkbox"/> Jackson <input type="checkbox"/> Pleasants <input type="checkbox"/> Ritchie <input type="checkbox"/> Roane <input type="checkbox"/> Wirt <input type="checkbox"/> Wood	<input type="checkbox"/> Doddridge <input type="checkbox"/> Harrison <input type="checkbox"/> Marion <input type="checkbox"/> Monongalia <input type="checkbox"/> Preston <input type="checkbox"/> Taylor	<input type="checkbox"/> Berkeley <input type="checkbox"/> Grant <input type="checkbox"/> Hampshire <input type="checkbox"/> Hardy <input type="checkbox"/> Jefferson <input type="checkbox"/> Mineral <input type="checkbox"/> Morgan	<input checked="" type="checkbox"/> Brooke <input checked="" type="checkbox"/> Hancock <input checked="" type="checkbox"/> Marshall <input checked="" type="checkbox"/> Ohio <input checked="" type="checkbox"/> Tyler <input checked="" type="checkbox"/> Wetzel	<input type="checkbox"/> Barbour <input type="checkbox"/> Braxton <input type="checkbox"/> Gilmer <input type="checkbox"/> Lewis <input type="checkbox"/> Upshur <input type="checkbox"/> Webster	<input type="checkbox"/> Pendleton <input type="checkbox"/> Pocahontas <input type="checkbox"/> Randolph <input type="checkbox"/> Tucker	<input type="checkbox"/> Fayette <input type="checkbox"/> Greenbrier <input type="checkbox"/> Monroe <input type="checkbox"/> Nicholas <input type="checkbox"/> Summers	<input type="checkbox"/> McDowell <input type="checkbox"/> Mercer <input type="checkbox"/> Raleigh <input type="checkbox"/> Wyoming

Part IV - Asphalt Pavement Repair (continued)

Contract Item #	Contract Item Description	Size of Project, per Mile	Unit of Measure	List Price
37		0-50 SY		\$22,000.00
38	Base Failure Repair, Asphalt	51-250 SY	Mile	\$23,000.00
39		251-500 SY		\$43,000.00
40		501 SY or greater		\$67,000.00
41		0-50 SY		\$21,600.00
42		51-250 SY	Mile	\$25,750.00
43	Base Failure Repair, Stone	251-500 SY		\$47,100.00
44		501 SY or greater		\$119,000.00
45		0-50 SY		\$28,600.00
46		51-250 SY	Mile	\$26,250.00
47	Edge Failure Repair	251-500 SY		\$66,000.00
48		501 SY or greater		\$128,000.00
49	Haul by Vendor First Ton Mile	---	Ton Mile	\$7.50
50	Haul by Vendor Each Additional Mile	---	Ton Mile	\$0.75
51	Waste Haul by Vendor per truck/driver	---	Hour	\$150.00
52	Off-Season Plant Opening First Day	---	Day	\$9,000.00
53	Off-Season Plant Opening Each Additional Day	---	Day	\$3,500.00
54	Daytime Mobilization	---	Lump Sum	\$2,500.00
55	Nighttime Mobilization	---	Lump Sum	\$5,000.00

VENDOR'S NAME: Cast & Baker Corporation

Vendor's Base of Operations: 2214 Washington Road

(Please provide physical address): Canonsburg, PA 15317

District 1	District 2	District 3	District 4	District 5	District 6	District 7	District 8	District 9	District 10
<input type="checkbox"/> Boone	<input type="checkbox"/> Cabell	<input type="checkbox"/> Calhoun	<input type="checkbox"/> Doddridge	<input type="checkbox"/> Berkeley	<input checked="" type="checkbox"/> Brooke	<input type="checkbox"/> Barbour	<input type="checkbox"/> Pendleton	<input type="checkbox"/> Fayette	<input type="checkbox"/> McDowell
<input type="checkbox"/> Clay	<input type="checkbox"/> Lincoln	<input type="checkbox"/> Jackson	<input type="checkbox"/> Harrison	<input type="checkbox"/> Grant	<input checked="" type="checkbox"/> Hancock	<input type="checkbox"/> Braxton	<input type="checkbox"/> Pocahontas	<input type="checkbox"/> Greenbrier	<input type="checkbox"/> Mercer
<input type="checkbox"/> Kanawha	<input type="checkbox"/> Logan	<input type="checkbox"/> Pleasants	<input type="checkbox"/> Marion	<input type="checkbox"/> Hampshire	<input checked="" type="checkbox"/> Marshall	<input type="checkbox"/> Gilmer	<input type="checkbox"/> Randolph	<input type="checkbox"/> Monroe	<input type="checkbox"/> Raleigh
<input type="checkbox"/> Mason	<input type="checkbox"/> Mingo	<input type="checkbox"/> Ritchie	<input type="checkbox"/> Monongalia	<input type="checkbox"/> Hardy	<input checked="" type="checkbox"/> Ohio	<input type="checkbox"/> Lewis	<input type="checkbox"/> Tucker	<input type="checkbox"/> Nicholas	<input type="checkbox"/> Wyoming
<input type="checkbox"/> Putnam	<input type="checkbox"/> Wayne	<input type="checkbox"/> Roane	<input type="checkbox"/> Preston	<input type="checkbox"/> Jefferson	<input checked="" type="checkbox"/> Tyler	<input type="checkbox"/> Upshur		<input type="checkbox"/> Summers	
		<input type="checkbox"/> Wirt	<input type="checkbox"/> Taylor	<input type="checkbox"/> Mineral	<input checked="" type="checkbox"/> Wetzel	<input type="checkbox"/> Webster			
		<input type="checkbox"/> Wood		<input type="checkbox"/> Morgan					
56	On-Site Mobilization								
	Lump Sum								\$1,175.00

Ditch, Pipe, and Asphalt Repair and Maintenance by the Vendor
ATTACHMENT A PRICING PAGE (ATT A)

Vendor Instructions: Vendor shall provide their name and Base of Operations physical address applicable to ATT A in the spaces below. If the vendor has multiple Base of Operations location addresses, vendor may insert additional lines. Vendor shall then mark with an "X" the counties that correspond with the bid prices on this page. If Vendor has varied pricing per county, Vendor shall complete a separate set of Pricing Pages (ATT A) for each county pricing set. Vendor must bid all Traffic Control Contract Items in Part I below. Vendors may bid any or all categories of work in Part II, Part III, or Part IV below, but must bid all Contract Items within a category of work to be awarded a contract.

This is a multiple vendor award contract. All qualifying vendors meeting the contract specifications will be awarded with a contract. The low bid vendor per project will be determined at the time of need, as per Section 4.1 of the Contract Specifications. Estimated quantities are not available.

VENDOR'S NAME: _____

Vendor's Base of Operations: _____

(Please provide physical address): _____

<i>District 1</i>	<i>District 2</i>	<i>District 3</i>	<i>District 4</i>	<i>District 5</i>	<i>District 6</i>	<i>District 7</i>	<i>District 8</i>	<i>District 9</i>	<i>District 10</i>
<input type="checkbox"/> Boone	<input type="checkbox"/> Cabell	<input type="checkbox"/> Calhoun	<input type="checkbox"/> Doddridge	<input type="checkbox"/> Berkeley	<input type="checkbox"/> Brooke	<input type="checkbox"/> Barbour	<input type="checkbox"/> Pendleton	<input type="checkbox"/> Fayette	<input type="checkbox"/> McDowell
<input type="checkbox"/> Clay	<input type="checkbox"/> Lincoln	<input type="checkbox"/> Jackson	<input type="checkbox"/> Harrison	<input type="checkbox"/> Grant	<input type="checkbox"/> Hancock	<input type="checkbox"/> Braxton	<input type="checkbox"/> Pocahontas	<input type="checkbox"/> Greenbrier	<input type="checkbox"/> Mercer
<input type="checkbox"/> Kanawha	<input type="checkbox"/> Logan	<input type="checkbox"/> Pleasants	<input type="checkbox"/> Marion	<input type="checkbox"/> Hampshire	<input type="checkbox"/> Marshall	<input type="checkbox"/> Gilmer	<input type="checkbox"/> Randolph	<input type="checkbox"/> Monroe	<input type="checkbox"/> Raleigh
<input type="checkbox"/> Mason	<input type="checkbox"/> Mingo	<input type="checkbox"/> Ritchie	<input type="checkbox"/> Monongalia	<input type="checkbox"/> Hardy	<input type="checkbox"/> Ohio	<input type="checkbox"/> Lewis	<input type="checkbox"/> Tucker	<input type="checkbox"/> Nicholas	<input type="checkbox"/> Wyoming
<input type="checkbox"/> Putnam	<input type="checkbox"/> Wayne	<input type="checkbox"/> Roane	<input type="checkbox"/> Preston	<input type="checkbox"/> Jefferson	<input type="checkbox"/> Tyler	<input type="checkbox"/> Upshur		<input type="checkbox"/> Summers	
		<input type="checkbox"/> Wirt	<input type="checkbox"/> Taylor	<input type="checkbox"/> Mineral	<input type="checkbox"/> Wetzel	<input type="checkbox"/> Webster			
		<input type="checkbox"/> Wood		<input type="checkbox"/> Morgan					

Part I - Traffic Control *required

Contract Item #	Contract Item Description	Unit of Measure	List Price
1	Pilot Truck and Driver	Day	
2	Traffic Control Devices	Unit	
3	Flagger	Hour	
4	Arrow Board	Day	

Ditch, Pipe, and Asphalt Repair and Maintenance by the Vendor
ATTACHMENT A PRICING PAGE (ATT A)

VENDOR'S NAME: _____

Vendor's Base of Operations: _____

(Please provide physical address): _____

<i>District 1</i>	<i>District 2</i>	<i>District 3</i>	<i>District 4</i>	<i>District 5</i>	<i>District 6</i>	<i>District 7</i>	<i>District 8</i>	<i>District 9</i>	<i>District 10</i>
<input type="checkbox"/> Boone	<input type="checkbox"/> Cabell	<input type="checkbox"/> Calhoun	<input type="checkbox"/> Doddridge	<input type="checkbox"/> Berkeley	<input type="checkbox"/> Brooke	<input type="checkbox"/> Barbour	<input type="checkbox"/> Pendleton	<input type="checkbox"/> Fayette	<input type="checkbox"/> McDowell
<input type="checkbox"/> Clay	<input type="checkbox"/> Lincoln	<input type="checkbox"/> Jackson	<input type="checkbox"/> Harrison	<input type="checkbox"/> Grant	<input type="checkbox"/> Hancock	<input type="checkbox"/> Braxton	<input type="checkbox"/> Pocahontas	<input type="checkbox"/> Greenbrier	<input type="checkbox"/> Mercer
<input type="checkbox"/> Kanawha	<input type="checkbox"/> Logan	<input type="checkbox"/> Pleasants	<input type="checkbox"/> Marion	<input type="checkbox"/> Hampshire	<input type="checkbox"/> Marshall	<input type="checkbox"/> Gilmer	<input type="checkbox"/> Randolph	<input type="checkbox"/> Monroe	<input type="checkbox"/> Raleigh
<input type="checkbox"/> Mason	<input type="checkbox"/> Mingo	<input type="checkbox"/> Ritchie	<input type="checkbox"/> Monongalia	<input type="checkbox"/> Hardy	<input type="checkbox"/> Ohio	<input type="checkbox"/> Lewis	<input type="checkbox"/> Tucker	<input type="checkbox"/> Nicholas	<input type="checkbox"/> Wyoming
<input type="checkbox"/> Putnam	<input type="checkbox"/> Wayne	<input type="checkbox"/> Roane	<input type="checkbox"/> Preston	<input type="checkbox"/> Jefferson	<input type="checkbox"/> Tyler	<input type="checkbox"/> Upshur		<input type="checkbox"/> Summers	
		<input type="checkbox"/> Wirt	<input type="checkbox"/> Taylor	<input type="checkbox"/> Mineral	<input type="checkbox"/> Wetzel	<input type="checkbox"/> Webster			
		<input type="checkbox"/> Wood		<input type="checkbox"/> Morgan					

Part II - Ditching Maintenance & Repair

Contract Item #	Contract Item Description	Unit of Measure	List Price
5	Ditching	Shoulder Mile	
6	Correcting Deep Ditches	Ton	
7	Restoring Shoulders and Shoulder Stone	Ton	
8	Shoulder Stone Placement	Ton	
9	Ditching Haul by Vendor for Contract Items 6, 7 & 8, First Ton Mile	Ton Mile	
10	Ditching Haul by Vendor for Contract Items 6, 7 & 8, Each Additional Mile	Ton Mile	
11	Ditching Waste Haul by Vendor per truck/driver	Hour	
12	Daytime Mobilization	Lump Sum	
13	Nighttime Mobilization	Lump Sum	
14	On-Site Mobilization	Lump Sum	

Part III - Pipe Repair & Replacement

Contract Item #	Contract Item Description	Unit of Measure	List Price
15	15" Type F Trench	Linear Foot	
16	18" Type F Trench	Linear Foot	
17	24" Type F Trench	Linear Foot	
18	30" Type F Trench	Linear Foot	
19	36" Type F Trench	Linear Foot	
20	42" Type F Trench	Linear Foot	
21	48" Type F Trench	Linear Foot	
22	54" Type F Trench	Linear Foot	

Ditch, Pipe, and Asphalt Repair and Maintenance by the Vendor
ATTACHMENT A PRICING PAGE (ATT A)

VENDOR'S NAME: _____

Vendor's Base of Operations: _____

(Please provide physical address): _____

<i>District 1</i>	<i>District 2</i>	<i>District 3</i>	<i>District 4</i>	<i>District 5</i>	<i>District 6</i>	<i>District 7</i>	<i>District 8</i>	<i>District 9</i>	<i>District 10</i>
<input type="checkbox"/> Boone	<input type="checkbox"/> Cabell	<input type="checkbox"/> Calhoun	<input type="checkbox"/> Doddridge	<input type="checkbox"/> Berkeley	<input type="checkbox"/> Brooke	<input type="checkbox"/> Barbour	<input type="checkbox"/> Pendleton	<input type="checkbox"/> Fayette	<input type="checkbox"/> McDowell
<input type="checkbox"/> Clay	<input type="checkbox"/> Lincoln	<input type="checkbox"/> Jackson	<input type="checkbox"/> Harrison	<input type="checkbox"/> Grant	<input type="checkbox"/> Hancock	<input type="checkbox"/> Braxton	<input type="checkbox"/> Pocahontas	<input type="checkbox"/> Greenbrier	<input type="checkbox"/> Mercer
<input type="checkbox"/> Kanawha	<input type="checkbox"/> Logan	<input type="checkbox"/> Pleasants	<input type="checkbox"/> Marion	<input type="checkbox"/> Hampshire	<input type="checkbox"/> Marshall	<input type="checkbox"/> Gilmer	<input type="checkbox"/> Randolph	<input type="checkbox"/> Monroe	<input type="checkbox"/> Raleigh
<input type="checkbox"/> Mason	<input type="checkbox"/> Mingo	<input type="checkbox"/> Ritchie	<input type="checkbox"/> Monongalia	<input type="checkbox"/> Hardy	<input type="checkbox"/> Ohio	<input type="checkbox"/> Lewis	<input type="checkbox"/> Tucker	<input type="checkbox"/> Nicholas	<input type="checkbox"/> Wyoming
<input type="checkbox"/> Putnam	<input type="checkbox"/> Wayne	<input type="checkbox"/> Roane	<input type="checkbox"/> Preston	<input type="checkbox"/> Jefferson	<input type="checkbox"/> Tyler	<input type="checkbox"/> Upshur		<input type="checkbox"/> Summers	
		<input type="checkbox"/> Wirt	<input type="checkbox"/> Taylor	<input type="checkbox"/> Mineral	<input type="checkbox"/> Wetzel	<input type="checkbox"/> Webster			
		<input type="checkbox"/> Wood		<input type="checkbox"/> Morgan					

Part III - Pipe Repair & Replacement (continued)

Contract Item #	Contract Item Description	Unit of Measure	List Price
23	60" Type F Trench	Linear Foot	
24	Pipe Repair/Replacement backfill for F Trench (material + delivery first 5 miles)	Cubic Yard	
25	Additional Haul per truck load over 5 miles, Backfill for F Trench	Mile	
26	Safe Access and Egress Surcharge depth of 5-foot to 10-foot	Lump Sum	
27	Safe Access and Egress Surcharge depth of 10-foot to 15-foot	Lump Sum	
28	Safe Access and Egress Surcharge depth 15-foot to 20-foot	Lump Sum	
29	Pipe Repair/Replacement Waste Haul by Vendor per truck/driver	Hour	
30	Daytime Mobilization	Lump Sum	
31	Nighttime Mobilization	Lump Sum	
32	On-Site Mobilization	Lump Sum	

Part IV - Asphalt Pavement Repair

Contract Item #	Contract Item Description	Size of Project, per Mile	Unit of Measure	List Price
33	Pothole Repair	0-50 SY	Mile	
34		51-250 SY		
35		251-500 SY		
36		501 SY or greater		

Ditch, Pipe, and Asphalt Repair and Maintenance by the Vendor
ATTACHMENT A PRICING PAGE (ATT A)

VENDOR'S NAME: _____

Vendor's Base of Operations: _____

(Please provide physical address): _____

- | | | | | | | | | | |
|--|---|--|---|--|---|--|--|---|--|
| <input type="checkbox"/> District 1
Boone
Clay
Kanawha
Mason
Putnam | <input type="checkbox"/> District 2
Cabell
Lincoln
Logan
Mingo
Wayne | <input type="checkbox"/> District 3
Calhoun
Jackson
Pleasants
Ritchie
Roane
Wirt
Wood | <input type="checkbox"/> District 4
Doddridge
Harrison
Marion
Monongalia
Preston
Taylor | <input type="checkbox"/> District 5
Berkeley
Grant
Hampshire
Hardy
Jefferson
Mineral
Morgan | <input type="checkbox"/> District 6
Brooke
Hancock
Marshall
Ohio
Tyler
Wetzel | <input type="checkbox"/> District 7
Barbour
Braxton
Glimmer
Lewis
Upshur
Webster | <input type="checkbox"/> District 8
Pendleton
Pocahontas
Randolph
Tucker | <input type="checkbox"/> District 9
Fayette
Greenbrier
Monroe
Nicholas
Summers | <input type="checkbox"/> District 10
McDowell
Mercer
Raleigh
Wyoming |
|--|---|--|---|--|---|--|--|---|--|

Part IV - Asphalt Pavement Repair (continued)

Contract Item #	Contract Item Description	Size of Project, per Mile	Unit of Measure	List Price
37	Base Failure Repair, Asphalt	0-50 SY	Mile	
38		51-250 SY		
39		251-500 SY		
40		501 SY or greater		
41	Base Failure Repair, Stone	0-50 SY	Mile	
42		51-250 SY		
43		251-500 SY		
44		501 SY or greater		
45	Edge Failure Repair	0-50 SY	Mile	
46		51-250 SY		
47		251-500 SY		
48		501 SY or greater		
49	Haul by Vendor First Ton Mile	---	Ton Mile	
50	Haul by Vendor Each Additional Mile	---	Ton Mile	
51	Waste Haul by Vendor per truck/driver	---	Hour	
52	Off-Season Plant Opening First Day	---	Day	
53	Off-Season Plant Opening Each Additional Day	---	Day	
54	Daytime Mobilization	---	Lump Sum	
55	Nighttime Mobilization	---	Lump Sum	
56	On-Site Mobilization	---	Lump Sum	

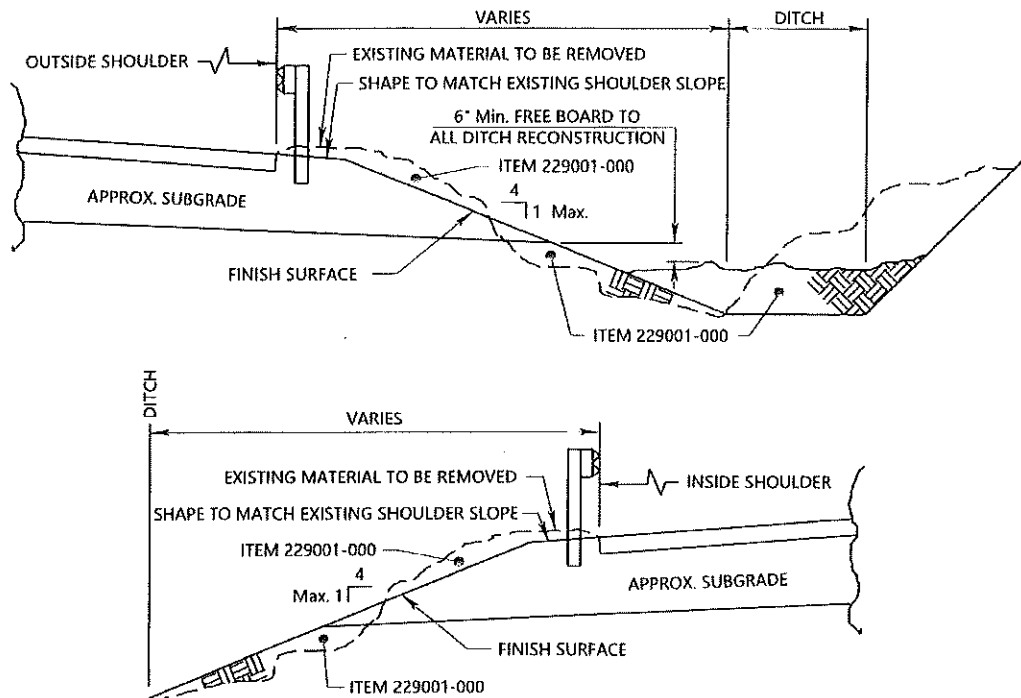

NOTES:

THIS DETAIL IS TO BE USED TO RE-ESTABLISH THE ORIGINAL CROSS SLOPE TO THE SHOULDER AND TO RE-ESTABLISH THE ORIGINAL DITCH DEPTH.

THE CONTRACTOR SHALL BE RESPONSIBLE FOR SHAPING THE SHOULDER CROSS SLOPE UNDER GUARDRAIL ON RESURFACING PROJECTS.

THE WEST VIRGINIA DEPARTMENT OF TRANSPORTATION DIVISION OF HIGHWAYS

SHOULDERS AND DITCHES

Public Road Dist.	State Dist. No.	State Project No.	Federal Project No.	County
W.V.				

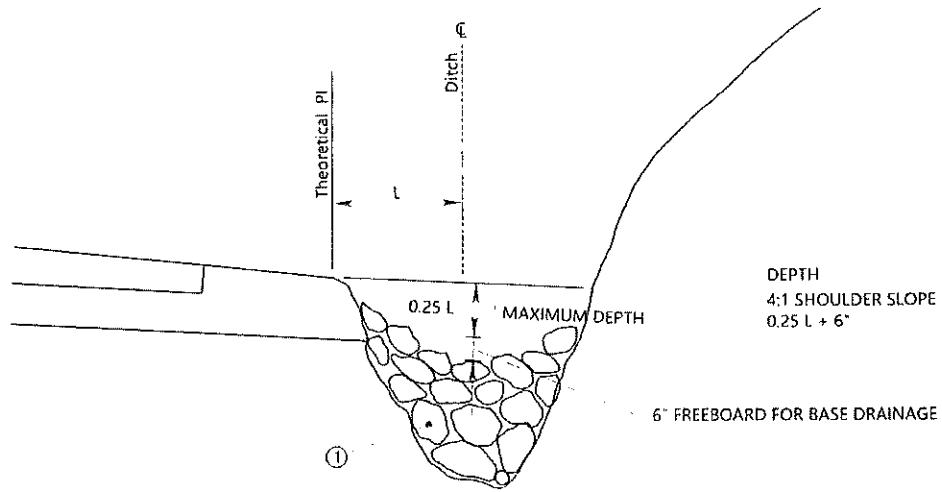

① Item 211008-000. ROCK BORROW EXCAVATION

The intent of this operation is to eliminate hazardous ditch areas where erosion, especially on steep grades, has deepened the ditches beyond the limits of safe vehicle operation. The maximum size of rock in the top layer should be 4"; however, larger rock will be permitted in lower layers as appropriate for the conditions.

THE WEST VIRGINIA DEPARTMENT OF TRANSPORTATION DIVISION OF HIGHWAYS
CORRECTING DEEP DITCHES

Public Roads Div	State Dist No	State Project No	Federal Project No	County
WV.				

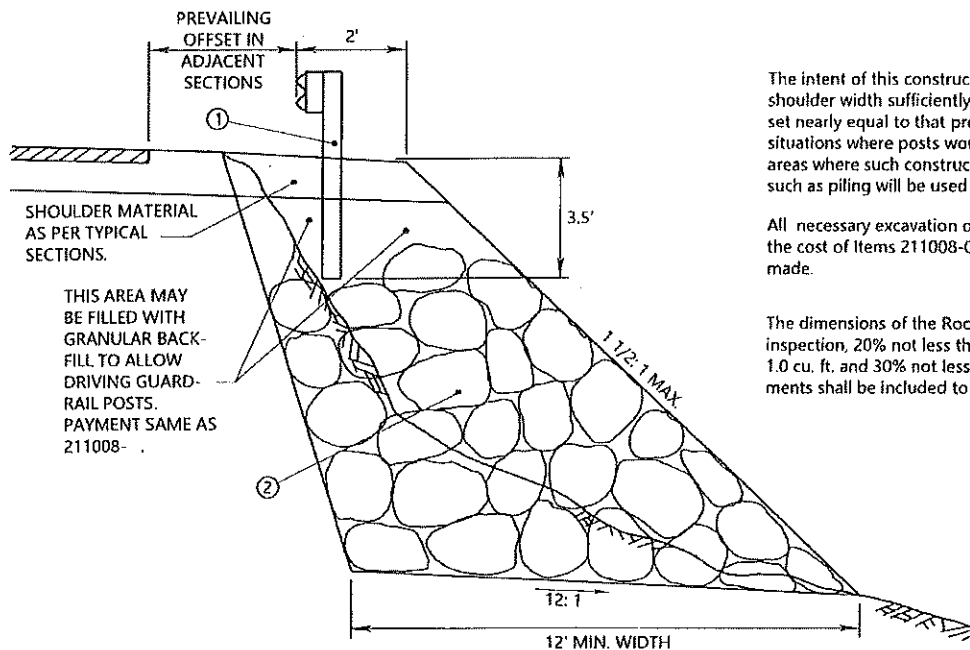

The intent of this construction is to restore, in limited areas, the shoulder width sufficiently to allow placing guardrail at an offset nearly equal to that prevailing in adjacent sections avoiding situations where posts would not provide proper strength, in areas where such construction is not practical, special designs such as piling will be used if specified in the plans.

All necessary excavation of the fill bench will be incidental to the cost of Items 211008-000, and no separate payment will be made.

The dimensions of the Rock Borrow shall be, based on visual inspection, 20% not less than 1.5 cu. ft., 50% not less than 1.0 cu. ft. and 30% not less than 0.5 cu. ft. Adequate rock fragments shall be included to fill the rock voids.

- ① ITEM 607001-001, TYPE I GUARDRAIL, CLASS (AS SHOWN ON PLANS)
- ② ITEM 21100*-000, ROCK BORROW EXCAVATION

* SEQUENCE NUMBER

THE WEST VIRGINIA DEPARTMENT OF TRANSPORTATION DIVISION OF HIGHWAYS

RESTORING SHOULDERS FOR GUARDRAIL & SLIVER FILLS

Public Roads Div.	State Dist. No.	State Project No.	Federal Project No.	County
W.V.				

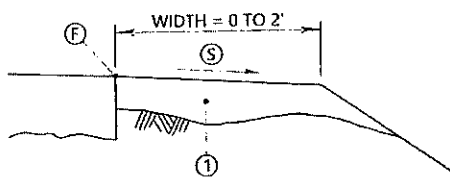
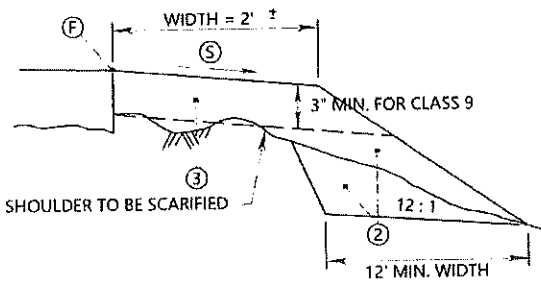
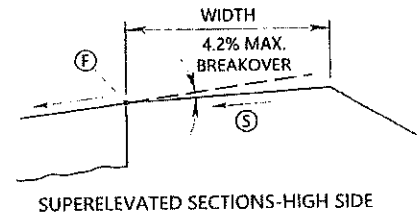
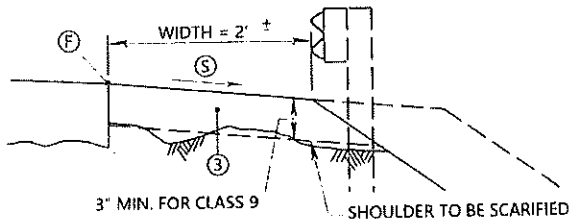

NORMAL SECTIONS

LEGEND

- ① ITEM 401001-*, ASHALT BASE COURSE, TYPE
- ② ITEM 211008-000, ROCK BORROW EXCAVATION
The intent of this item is to provide proper foundation for the shoulder while restoring the original shoulder width reduced by erosion. Additional material, as directed by the Engineer, may be required by recent erosion and will be paid for as 211008-000. Excavation of benches for placing, 211008-000 will be included in 211008-000.
- ③ ITEM 307005-001, AGGREGATE BASE COURSE, CLASS 10
This item includes any necessary removal of existing shoulder material to a minimum of 3" below the finished pavement elevation when Class 9 aggregate is specified. Material removed shall be reused within the project limits or wasted as directed by the Engineer. Scarifying shall be in accordance with Section 308.3.1 of the Specifications.
- ⓕ FINISHED PAVEMENT ELEVATION
- Ⓢ SHOULDER SLOPE
Normal Sections : 6 %.
Superelevated : Match rate of superelevation or reduce as shown above
Minimum slope to be 1/4" per foot, on low side of superelevation.
Paved Shoulders : 4 % or superelevated.

* SEQUENCE NUMBER

THE WEST VIRGINIA DEPARTMENT OF TRANSPORTATION DIVISION OF HIGHWAYS

SHOULDER RECONSTRUCTION

Public Roads Div.	State Dist. No.	State Project No.	Federal Project No.	County
W.V.				

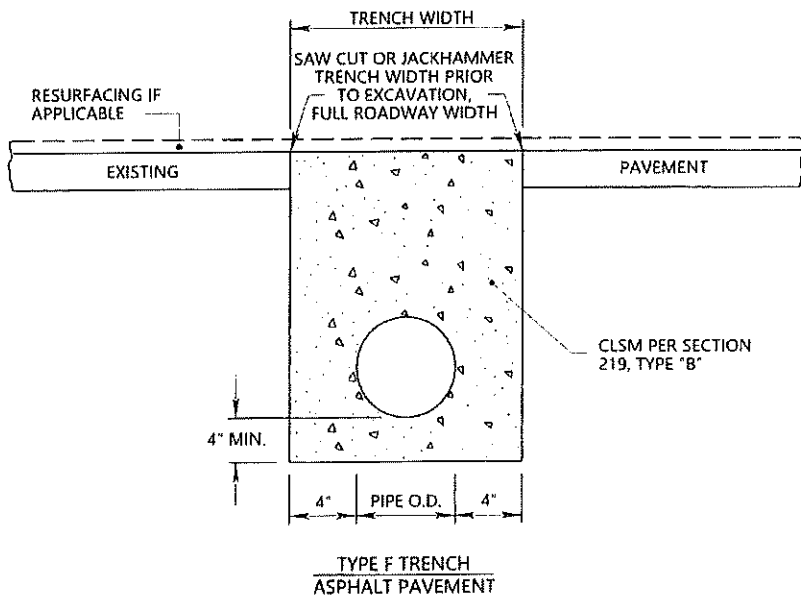

WHEN NO OVERLAY IS SPECIFIED THE CONTROLLED LOW-STRENGTH MATERIAL (CLSM) SHALL BE A MIN. OF 2000 psi FOR DOH PIPES ONLY. NOT TO BE USED FOR UTILITY PIPES.

NOTE: IF TYPE F TRENCH IS USED WHERE THERE IS NO EXISTING OR PROPOSED INLET, THE CLSM SHALL BE POURED FULL DEPTH 2" PAST EACH E.P. THE PIPE SHALL BE ENCASED IN 4" OF CLSM AN ADDITIONAL 10' MAX. BEYOND E.P. IF THERE IS AN EXISTING OR PROPOSED INLET THE CLSM SHALL BE POURED FULL DEPTH TO THE INLET.

THE WEST VIRGINIA DEPARTMENT OF TRANSPORTATION DIVISION OF HIGHWAYS

REPAVING PIPE TRENCHES IN PAVED SHOULDER

Public Roads Div.	State Dist. No.	State Project No.	Federal Project No.	County
W.V.				

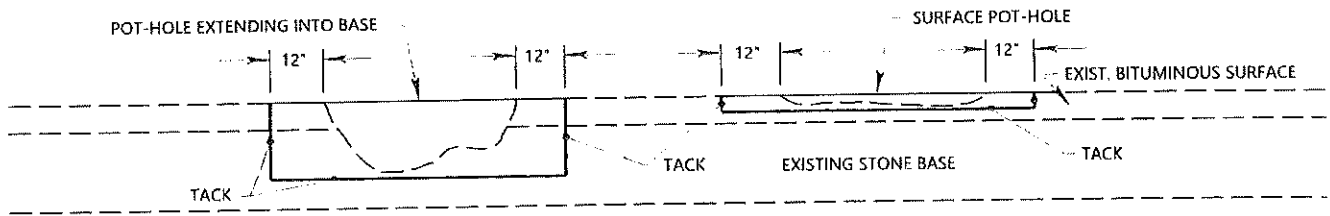

(ELEVATION VIEW)

THE SIDES AND BOTTOMS MUST BE CLEANED AFTER THE HOLE IS SHAPED TO FROM A SQUARE OR RECTANGLE WHOSE SIDES ARE PARALLEL OR AT RIGHT ANGLES TO THE DIRECTION OF TRAFFIC WITH THE EDGES NEAT AND AS NEARLY VERTICAL AS POSSIBLE.

THE EXISTING BASE WILL BE REPLACED WITH ASPHALT.

THE REMAINING SURFACE POT-HOLE WILL BE FILLED WITH ASPHALT BASE COURSE TYPE MEETING REQUIREMENTS OF SECTION 401 OF THE SPECS. ENOUGH MATERIAL MUST BE USED TO BRING THE SURFACE OF REPAIR ABOUT $\frac{1}{4}$ " ABOVE THE LEVEL OF THE ORIGINAL PAVEMENT TO ALLOW FOR FURTHER COMPACTION BY TRAFFIC AND/OR RESURFACING.

THE WEST VIRGINIA DEPARTMENT OF TRANSPORTATION DIVISION OF HIGHWAYS

POT-HOLE REPAIR DETAIL

Public Roads Div.	State Dist. No.	State Project No.	Federal Project No.	County
W.V.				

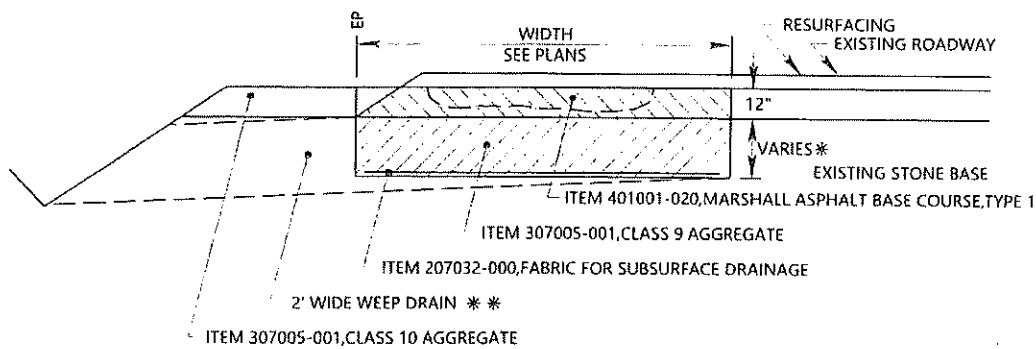

(ELEVATION VIEW)

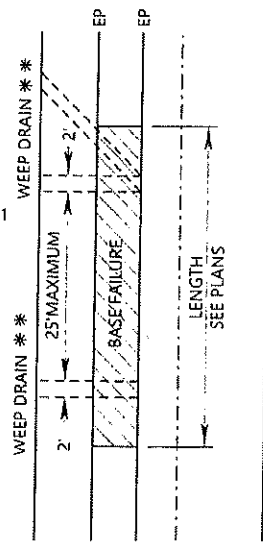

(PLAN VIEW)

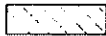
 TRENCH EXCAVATION SHALL BE SHAPED TO FROM A SQUARE OR RECTANGLE WHOSE SIDES ARE PARALLEL WITH AND AT RIGHT ANGLES TO THE DIRECTION OF TRAFFIC. PAVEMENT SHALL BE SAW CUT AND SIDES OF TRENCH EXCAVATED TO NEAR VERTICAL AS POSSIBLE. ALL LOOSE MATERIAL SHALL BE REMOVED FROM THE TRENCH BOTTOM PRIOR TO PLACING FABRIC. PAYMENT FOR EXCAVATION TO BE ITEM 207001-001, UNCLASSIFIED EXCAVATION.

* THICKNESS OF ITEM 307005-001, CLASS 9 AGGREGATE, TO BE AS DIRECTED BY THE ENGINEER (ESTIMATED AT 6")

** WEEP DRAINS SHALL BE LOCATED AT ALL LOW POINTS IN TRENCH. MAXIMUM SPACING BETWEEN WEEP DRAINS SHALL BE TWENTY FIVE (25) FEET. DRAINS MAY BE SKEWED WHERE NECESSARY TO MAINTAIN SLOPE AWAY FROM THE TRENCH AREA. PAYMENT FOR WEEP DRAINS TO BE INCLUDED IN ITEM 307005-001, CLASS 9 AGGREGATE BASE COURSE.

THE WEST VIRGINIA DEPARTMENT OF TRANSPORTATION DIVISION OF HIGHWAYS
BASE FAILURE REPAIR DETAIL

Public Roads Div.	State Dist. No.	State Project No.	Federal Project No.	County
W.V.				

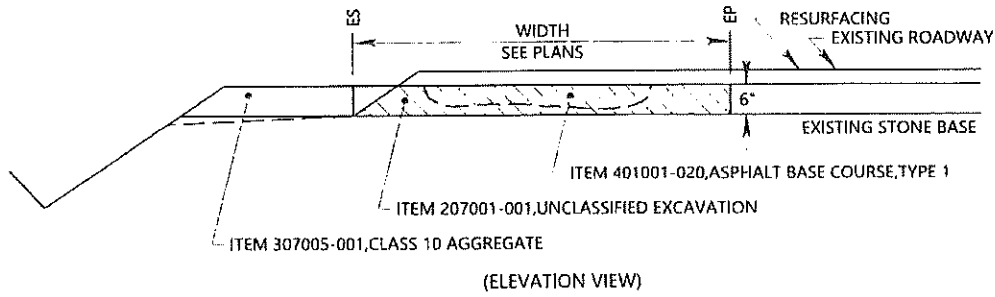

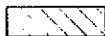
 TRENCH EXCAVATION SHALL BE SHAPED TO FROM A SQUARE OR RECTANGLE WHOSE SIDES ARE PARALLEL WITH AND AT RIGHT ANGLES TO THE DIRECTION OF TRAFFIC. PAVEMENT SHALL BE SAW CUT AND SIDES OF TRENCH EXCAVATED TO NEAR VERTICAL AS POSSIBLE. ALL LOOSE MATERIAL SHALL BE REMOVED FROM THE TRENCH BOTTOM PRIOR TO PLACING ASPHALT.

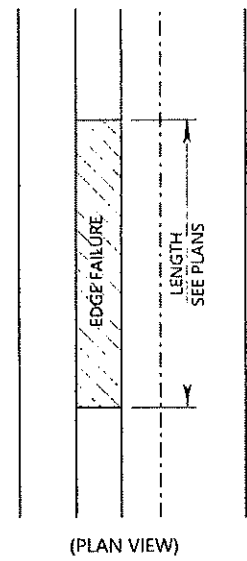

THE WEST VIRGINIA DEPARTMENT OF TRANSPORTATION DIVISION OF HIGHWAYS

EDGE FAILURE REPAIR DETAIL

Public Roads Div.	State Dist. No.	State Project No.	Federal Project No.	County
W.V.				



**State of West Virginia
Agency Request for Quote
Highways**

Proc Folder: 1593441			Reason for Modification: Addendum 01 To attach responses to questions from vendors and revised specifications.
Doc Description: Ditch, Pipe and Asphalt Repair and Maintenance by the Vendor			
Proc Type: Agency Master Agreement			
Date Issued	Solicitation Closes	Solicitation No	Version
2025-01-15	2025-01-23 10:30	ARFQ 0803 DOT2500000026	2

BID RECEIVING LOCATION

PROCUREMENT DIVISION
 DIVISION OF HIGHWAYS
 BLDG 6 RM 340A
 1900 KANAWHA BLVD E
 CHARLESTON WV 25305
 US

VENDOR

Vendor Customer Code: 000000160630
Vendor Name : Cast & Baker Corporation
Address : 2214 Washington Road
Street : 2214 Washington Road
City : Cannonsburg
State : Pennsylvania **Country :** USA **Zip :** 15317
Principal Contact :
Vendor Contact Phone: **Extension:**

FOR INFORMATION CONTACT THE BUYER
 Jeromie F Lanham
 304-720-7383
 jeromie.f.lanham@wv.gov

Vendor Signature X  **Michael J. Baker FEIN# 251428005** **DATE 1/20/25**

All offers subject to all terms and conditions contained in this solicitation

ADDITIONAL INFORMATION

ADDENDUM

ADDENDUM 1 IS ISSUED FOR THE FOLLOWING REASONS:

- 1. TO ATTACH RESPONSES TO QUESTIONS FROM VENDORS
- 2. TO ATTACH REVISED SPECIFICATIONS

NO OTHER CHANGES

INVOICE TO		SHIP TO	
VARIOUS AGENCY LOCATIONS AS INDICATED BY ORDER		VARIOUS AGENCY LOCATIONS AS INDICATED BY ORDER	
No City US	WV	No City US	WV

Line	Comm Ln Desc	Qty	Unit Issue	Unit Price	Total Price
1	Pilot Truck and Driver	0.00000	DAY		

Comm Code	Manufacturer	Specification	Model #
46161500			

Extended Description:
See Attached Pricing Page- Attachment A, For Actual Cost.

INVOICE TO		SHIP TO	
VARIOUS AGENCY LOCATIONS AS INDICATED BY ORDER		VARIOUS AGENCY LOCATIONS AS INDICATED BY ORDER	
No City US	WV	No City US	WV

Line	Comm Ln Desc	Qty	Unit Issue	Unit Price	Total Price
2	Traffic Control Devices	0.00000	UNIT		

Comm Code	Manufacturer	Specification	Model #
46161500			

Extended Description:
See Attached Pricing Page- Attachment A, For Actual Cost.

INVOICE TO	SHIP TO
------------	---------

VARIOUS AGENCY
LOCATIONS
AS INDICATED BY ORDER

VARIOUS AGENCY
LOCATIONS
AS INDICATED BY ORDER

No City WV
US

No City WV
US

Line	Comm Ln Desc	Qty	Unit Issue	Unit Price	Total Price
3	Traffic Flagger	0.00000	HOUR		

Comm Code	Manufacturer	Specification	Model #
46161500			

Extended Description:
See Attached Pricing Page- Attachment A, For Actual Cost.

INVOICE TO	SHIP TO
------------	---------

VARIOUS AGENCY
LOCATIONS
AS INDICATED BY ORDER

VARIOUS AGENCY
LOCATIONS
AS INDICATED BY ORDER

No City WV
US

No City WV
US

Line	Comm Ln Desc	Qty	Unit Issue	Unit Price	Total Price
4	Arrow Board	0.00000	DAY		

Comm Code	Manufacturer	Specification	Model #
46161500			

Extended Description:
See Attached Pricing Page- Attachment A, For Actual Cost.

INVOICE TO		SHIP TO	
VARIOUS AGENCY LOCATIONS AS INDICATED BY ORDER		VARIOUS AGENCY LOCATIONS AS INDICATED BY ORDER	
No City	WV	No City	WV
US		US	

Line	Comm Ln Desc	Qty	Unit Issue	Unit Price	Total Price
5	Ditching (Shoulder Mile)	0.00000	MILE		

Comm Code	Manufacturer	Specification	Model #
72141003			

Extended Description:
See Attached Pricing Page- Attachment A, For Actual Cost.

INVOICE TO		SHIP TO	
VARIOUS AGENCY LOCATIONS AS INDICATED BY ORDER		VARIOUS AGENCY LOCATIONS AS INDICATED BY ORDER	
No City	WV	No City	WV
US		US	

Line	Comm Ln Desc	Qty	Unit Issue	Unit Price	Total Price
6	Correcting Deep Ditches	0.00000	TON		

Comm Code	Manufacturer	Specification	Model #
72141003			

Extended Description:
See Attached Pricing Page- Attachment A, For Actual Cost.

INVOICE TO		SHIP TO	
VARIOUS AGENCY LOCATIONS AS INDICATED BY ORDER		VARIOUS AGENCY LOCATIONS AS INDICATED BY ORDER	
No City	WV	No City	WV
US		US	

Line	Comm Ln Desc	Qty	Unit Issue	Unit Price	Total Price
7	Restoring Shoulders and Shoulder Stone	0.00000	TON		

Comm Code	Manufacturer	Specification	Model #
72141003			

Extended Description:

See Attached Pricing Page- Attachment A, For Actual Cost.

INVOICE TO		SHIP TO	
VARIOUS AGENCY LOCATIONS AS INDICATED BY ORDER		VARIOUS AGENCY LOCATIONS AS INDICATED BY ORDER	
No City	WV	No City	WV
US		US	

Line	Comm Ln Desc	Qty	Unit Issue	Unit Price	Total Price
8	Shoulder Stone Placement	0.00000	TON		

Comm Code	Manufacturer	Specification	Model #
72141003			

Extended Description:

See Attached Pricing Page- Attachment A, For Actual Cost.

INVOICE TO	SHIP TO
------------	---------

VARIOUS AGENCY
LOCATIONS
AS INDICATED BY ORDER

VARIOUS AGENCY
LOCATIONS
AS INDICATED BY ORDER

No City WV
US

No City WV
US

Line	Comm Ln Desc	Qty	Unit Issue	Unit Price	Total Price
9	Ditching Haul by Vendor for Items 6, 7 & 8 (Ton Mile)	0.00000	MILE		

Comm Code	Manufacturer	Specification	Model #
72141003			

Extended Description:
See Attached Pricing Page- Attachment A, For Actual Cost.

INVOICE TO	SHIP TO
------------	---------

VARIOUS AGENCY
LOCATIONS
AS INDICATED BY ORDER

VARIOUS AGENCY
LOCATIONS
AS INDICATED BY ORDER

No City WV
US

No City WV
US

Line	Comm Ln Desc	Qty	Unit Issue	Unit Price	Total Price
10	Ditching Haul for Items 6, 7 & 8 Addl' Mile (Ton Mile)	0.00000	MILE		

Comm Code	Manufacturer	Specification	Model #
72141003			

Extended Description:
See Attached Pricing Page- Attachment A, For Actual Cost.

INVOICE TO	SHIP TO
------------	---------

VARIOUS AGENCY
LOCATIONS
AS INDICATED BY ORDER

VARIOUS AGENCY
LOCATIONS
AS INDICATED BY ORDER

No City WV
US

No City WV
US

Line	Comm Ln Desc	Qty	Unit Issue	Unit Price	Total Price
11	Ditching Waste Haul by Vendor per Truck/ Driver	0.00000	HOURL		

Comm Code	Manufacturer	Specification	Model #
72153507			

Extended Description:
See Attached Pricing Page- Attachment A, For Actual Cost.

INVOICE TO	SHIP TO
------------	---------

VARIOUS AGENCY
LOCATIONS
AS INDICATED BY ORDER

VARIOUS AGENCY
LOCATIONS
AS INDICATED BY ORDER

No City WV
US

No City WV
US

Line	Comm Ln Desc	Qty	Unit Issue	Unit Price	Total Price
12	Ditching Daytime Mobilization	0.00000	LS		

Comm Code	Manufacturer	Specification	Model #
24000000			

Extended Description:
See Attached Pricing Page- Attachment A, For Actual Cost.

INVOICE TO	SHIP TO
------------	---------

VARIOUS AGENCY
LOCATIONS
AS INDICATED BY ORDER

VARIOUS AGENCY
LOCATIONS
AS INDICATED BY ORDER

No City WV
US

No City WV
US

Line	Comm Ln Desc	Qty	Unit Issue	Unit Price	Total Price
13	Ditching Nighttime Mobilization.	0.00000	LS		

Comm Code	Manufacturer	Specification	Model #
24000000			

Extended Description:
See Attached Pricing Page- Attachment A, For Actual Cost.

INVOICE TO	SHIP TO
------------	---------

VARIOUS AGENCY
LOCATIONS
AS INDICATED BY ORDER

VARIOUS AGENCY
LOCATIONS
AS INDICATED BY ORDER

No City WV
US

No City WV
US

Line	Comm Ln Desc	Qty	Unit Issue	Unit Price	Total Price
14	Ditching On-Site Mobilization	0.00000	LS		

Comm Code	Manufacturer	Specification	Model #
24000000			

Extended Description:
See Attached Pricing Page- Attachment A, For Actual Cost.

INVOICE TO	SHIP TO
------------	---------

VARIOUS AGENCY
LOCATIONS
AS INDICATED BY ORDER

VARIOUS AGENCY
LOCATIONS
AS INDICATED BY ORDER

No City WV
US

No City WV
US

Line	Comm Ln Desc	Qty	Unit Issue	Unit Price	Total Price
15	15" Type F Trench	0.00000	LF		

Comm Code	Manufacturer	Specification	Model #
72141100			

Extended Description:
See Attached Pricing Page- Attachment A, For Actual Cost.

INVOICE TO	SHIP TO
------------	---------

VARIOUS AGENCY
LOCATIONS
AS INDICATED BY ORDER

VARIOUS AGENCY
LOCATIONS
AS INDICATED BY ORDER

No City WV
US

No City WV
US

Line	Comm Ln Desc	Qty	Unit Issue	Unit Price	Total Price
16	18" Type F Trench	0.00000	LF		

Comm Code	Manufacturer	Specification	Model #
72141100			

Extended Description:
See Attached Pricing Page- Attachment A, For Actual Cost.

INVOICE TO		SHIP TO	
VARIOUS AGENCY LOCATIONS AS INDICATED BY ORDER		VARIOUS AGENCY LOCATIONS AS INDICATED BY ORDER	
No City	WV	No City	WV
US		US	

Line	Comm Ln Desc	Qty	Unit Issue	Unit Price	Total Price
17	24" Type F Trench	0.00000	LF		

Comm Code	Manufacturer	Specification	Model #
72141100			

Extended Description:

See Attached Pricing Page- Attachment A, For Actual Cost.

INVOICE TO		SHIP TO	
VARIOUS AGENCY LOCATIONS AS INDICATED BY ORDER		VARIOUS AGENCY LOCATIONS AS INDICATED BY ORDER	
No City	WV	No City	WV
US		US	

Line	Comm Ln Desc	Qty	Unit Issue	Unit Price	Total Price
18	30" Type F Trench	0.00000	LF		

Comm Code	Manufacturer	Specification	Model #
72141100			

Extended Description:

See Attached Pricing Page- Attachment A, For Actual Cost.

INVOICE TO	SHIP TO
------------	---------

VARIOUS AGENCY
LOCATIONS
AS INDICATED BY ORDER

VARIOUS AGENCY
LOCATIONS
AS INDICATED BY ORDER

No City WV
US

No City WV
US

Line	Comm Ln Desc	Qty	Unit Issue	Unit Price	Total Price
19	36" Type F Trench	0.00000	LF		

Comm Code	Manufacturer	Specification	Model #
72141100			

Extended Description:
See Attached Pricing Page- Attachment A, For Actual Cost.

INVOICE TO	SHIP TO
------------	---------

VARIOUS AGENCY
LOCATIONS
AS INDICATED BY ORDER

VARIOUS AGENCY
LOCATIONS
AS INDICATED BY ORDER

No City WV
US

No City WV
US

Line	Comm Ln Desc	Qty	Unit Issue	Unit Price	Total Price
20	42" Type F Trench	0.00000	LF		

Comm Code	Manufacturer	Specification	Model #
72141100			

Extended Description:
See Attached Pricing Page- Attachment A, For Actual Cost.

INVOICE TO	SHIP TO
------------	---------

VARIOUS AGENCY
LOCATIONS
AS INDICATED BY ORDER

VARIOUS AGENCY
LOCATIONS
AS INDICATED BY ORDER

No City WV
US

No City WV
US

Line	Comm Ln Desc	Qty	Unit Issue	Unit Price	Total Price
21	48" Type F Trench	0.00000	LF		

Comm Code	Manufacturer	Specification	Model #
72141100			

Extended Description:
See Attached Pricing Page- Attachment A, For Actual Cost.

INVOICE TO	SHIP TO
------------	---------

VARIOUS AGENCY
LOCATIONS
AS INDICATED BY ORDER

VARIOUS AGENCY
LOCATIONS
AS INDICATED BY ORDER

No City WV
US

No City WV
US

Line	Comm Ln Desc	Qty	Unit Issue	Unit Price	Total Price
22	54" Type F Trench	0.00000	LF		

Comm Code	Manufacturer	Specification	Model #
72141100			

Extended Description:
See Attached Pricing Page- Attachment A, For Actual Cost.

INVOICE TO	SHIP TO
------------	---------

VARIOUS AGENCY
LOCATIONS
AS INDICATED BY ORDER

VARIOUS AGENCY
LOCATIONS
AS INDICATED BY ORDER

No City WV
US

No City WV
US

Line	Comm Ln Desc	Qty	Unit Issue	Unit Price	Total Price
23	60" Type f Trench	0.00000	LF		

Comm Code	Manufacturer	Specification	Model #
72141100			

Extended Description:
See Attached Pricing Page- Attachment A, For Actual Cost.

INVOICE TO	SHIP TO
------------	---------

VARIOUS AGENCY
LOCATIONS
AS INDICATED BY ORDER

VARIOUS AGENCY
LOCATIONS
AS INDICATED BY ORDER

No City WV
US

No City WV
US

Line	Comm Ln Desc	Qty	Unit Issue	Unit Price	Total Price
24	Pipe Repair/Replacement backfill for F Trench (mat+first5mi)	0.00000	CY		

Comm Code	Manufacturer	Specification	Model #
72141100			

Extended Description:
See Attached Pricing Page- Attachment A, For Actual Cost.

INVOICE TO	SHIP TO
------------	---------

VARIOUS AGENCY
LOCATIONS
AS INDICATED BY ORDER

VARIOUS AGENCY
LOCATIONS
AS INDICATED BY ORDER

No City WV
US

No City WV
US

Line	Comm Ln Desc	Qty	Unit Issue	Unit Price	Total Price
25	Additional Haul per truck load over 5mi, Backfill F Trench	0.00000	MILE		

Comm Code	Manufacturer	Specification	Model #
72141100			

Extended Description:
See Attached Pricing Page- Attachment A, For Actual Cost.

INVOICE TO	SHIP TO
------------	---------

VARIOUS AGENCY
LOCATIONS
AS INDICATED BY ORDER

VARIOUS AGENCY
LOCATIONS
AS INDICATED BY ORDER

No City WV
US

No City WV
US

Line	Comm Ln Desc	Qty	Unit Issue	Unit Price	Total Price
26	Safe Access & Egress Surcharge depth of 5ft to 10ft	0.00000	LS		

Comm Code	Manufacturer	Specification	Model #
72141100			

Extended Description:
See Attached Pricing Page- Attachment A, For Actual Cost.

INVOICE TO	SHIP TO
------------	---------

VARIOUS AGENCY
LOCATIONS
AS INDICATED BY ORDER

VARIOUS AGENCY
LOCATIONS
AS INDICATED BY ORDER

No City WV
US

No City WV
US

Line	Comm Ln Desc	Qty	Unit Issue	Unit Price	Total Price
27	Safe Access & Egress Surcharge depth of 10ft to 15ft	0.00000	LS		

Comm Code	Manufacturer	Specification	Model #
72141100			

Extended Description:
See Attached Pricing Page- Attachment A, For Actual Cost.

INVOICE TO	SHIP TO
------------	---------

VARIOUS AGENCY
LOCATIONS
AS INDICATED BY ORDER

VARIOUS AGENCY
LOCATIONS
AS INDICATED BY ORDER

No City WV
US

No City WV
US

Line	Comm Ln Desc	Qty	Unit Issue	Unit Price	Total Price
28	Safe Access & Egress Surcharge depth 15ft to 20ft	0.00000	LS		

Comm Code	Manufacturer	Specification	Model #
72141100			

Extended Description:
See Attached Pricing Page- Attachment A, For Actual Cost.

INVOICE TO	SHIP TO
------------	---------

VARIOUS AGENCY
LOCATIONS
AS INDICATED BY ORDER

VARIOUS AGENCY
LOCATIONS
AS INDICATED BY ORDER

No City WV
US

No City WV
US

Line	Comm Ln Desc	Qty	Unit Issue	Unit Price	Total Price
29	Pipe Repair/Replacement Waste Haul by Vendor -truck/driver	0.00000	HOOR		

Comm Code	Manufacturer	Specification	Model #
72153507			

Extended Description:
See Attached Pricing Page- Attachment A, For Actual Cost.

INVOICE TO	SHIP TO
------------	---------

VARIOUS AGENCY
LOCATIONS
AS INDICATED BY ORDER

VARIOUS AGENCY
LOCATIONS
AS INDICATED BY ORDER

No City WV
US

No City WV
US

Line	Comm Ln Desc	Qty	Unit Issue	Unit Price	Total Price
30	Pipe Repair/Replacement Daytime Mobilization	0.00000	LS		

Comm Code	Manufacturer	Specification	Model #
24000000			

Extended Description:
See Attached Pricing Page- Attachment A, For Actual Cost.

INVOICE TO	SHIP TO
------------	---------

VARIOUS AGENCY
LOCATIONS
AS INDICATED BY ORDER

VARIOUS AGENCY
LOCATIONS
AS INDICATED BY ORDER

No City WV
US

No City WV
US

Line	Comm Ln Desc	Qty	Unit Issue	Unit Price	Total Price
31	Pipe Repair/Replacement Nighttime Mobilization	0.00000	LS		

Comm Code	Manufacturer	Specification	Model #
24000000			

Extended Description:
See Attached Pricing Page- Attachment A, For Actual Cost.

INVOICE TO	SHIP TO
------------	---------

VARIOUS AGENCY
LOCATIONS
AS INDICATED BY ORDER

VARIOUS AGENCY
LOCATIONS
AS INDICATED BY ORDER

No City WV
US

No City WV
US

Line	Comm Ln Desc	Qty	Unit Issue	Unit Price	Total Price
32	Pipe Repair/Replacement On-Site Mobilization	0.00000	LS		

Comm Code	Manufacturer	Specification	Model #
24000000			

Extended Description:
See Attached Pricing Page- Attachment A, For Actual Cost.

INVOICE TO	SHIP TO
------------	---------

VARIOUS AGENCY
LOCATIONS
AS INDICATED BY ORDER

VARIOUS AGENCY
LOCATIONS
AS INDICATED BY ORDER

No City WV
US

No City WV
US

Line	Comm Ln Desc	Qty	Unit Issue	Unit Price	Total Price
33	Pothole Repair (Per Project Size Range)	0.00000	MILE		

Comm Code	Manufacturer	Specification	Model #
72141100			

Extended Description:
See Attached Pricing Page- Attachment A, For Actual Cost.

INVOICE TO	SHIP TO
------------	---------

VARIOUS AGENCY
LOCATIONS
AS INDICATED BY ORDER

VARIOUS AGENCY
LOCATIONS
AS INDICATED BY ORDER

No City WV
US

No City WV
US

Line	Comm Ln Desc	Qty	Unit Issue	Unit Price	Total Price
34	Base Failure Repair, Asphalt (Per Project Size Range)	0.00000	MILE		

Comm Code	Manufacturer	Specification	Model #
72141100			

Extended Description:
See Attached Pricing Page- Attachment A, For Actual Cost.

INVOICE TO	SHIP TO
------------	---------

VARIOUS AGENCY
LOCATIONS
AS INDICATED BY ORDER

VARIOUS AGENCY
LOCATIONS
AS INDICATED BY ORDER

No City WV
US

No City WV
US

Line	Comm Ln Desc	Qty	Unit Issue	Unit Price	Total Price
35	Base Failure Repair, Stone (Per Project Size Range)	0.00000	MILE		

Comm Code	Manufacturer	Specification	Model #
72141100			

Extended Description:
See Attached Pricing Page- Attachment A, For Actual Cost.

INVOICE TO	SHIP TO
------------	---------

VARIOUS AGENCY
LOCATIONS
AS INDICATED BY ORDER

VARIOUS AGENCY
LOCATIONS
AS INDICATED BY ORDER

No City WV
US

No City WV
US

Line	Comm Ln Desc	Qty	Unit Issue	Unit Price	Total Price
36	Edge Failure Repair (Per Project Size Range)	0.00000	MILE		

Comm Code	Manufacturer	Specification	Model #
72141100			

Extended Description:
See Attached Pricing Page- Attachment A, For Actual Cost.

INVOICE TO	SHIP TO
------------	---------

VARIOUS AGENCY
LOCATIONS
AS INDICATED BY ORDER

VARIOUS AGENCY
LOCATIONS
AS INDICATED BY ORDER

No City WV
US

No City WV
US

Line	Comm Ln Desc	Qty	Unit Issue	Unit Price	Total Price
37	Haul by Vendor First Ton Mile	0.00000	MILE		

Comm Code	Manufacturer	Specification	Model #
72141100			

Extended Description:
See Attached Pricing Page- Attachment A, For Actual Cost.

INVOICE TO	SHIP TO
------------	---------

VARIOUS AGENCY
LOCATIONS
AS INDICATED BY ORDER

VARIOUS AGENCY
LOCATIONS
AS INDICATED BY ORDER

No City WV
US

No City WV
US

Line	Comm Ln Desc	Qty	Unit Issue	Unit Price	Total Price
38	Haul by Vendor Each Additional Mile (Ton Mile)	0.00000	MILE		

Comm Code	Manufacturer	Specification	Model #
72141100			

Extended Description:
See Attached Pricing Page- Attachment A, For Actual Cost.

INVOICE TO	SHIP TO
------------	---------

VARIOUS AGENCY
LOCATIONS
AS INDICATED BY ORDER

VARIOUS AGENCY
LOCATIONS
AS INDICATED BY ORDER

No City WV
US

No City WV
US

Line	Comm Ln Desc	Qty	Unit Issue	Unit Price	Total Price
39	Waste Haul by Vendor per truck/driver	0.00000	HOUR		

Comm Code	Manufacturer	Specification	Model #
72153507			

Extended Description:
See Attached Pricing Page- Attachment A, For Actual Cost.

INVOICE TO	SHIP TO
------------	---------

VARIOUS AGENCY
LOCATIONS
AS INDICATED BY ORDER

VARIOUS AGENCY
LOCATIONS
AS INDICATED BY ORDER

No City WV
US

No City WV
US

Line	Comm Ln Desc	Qty	Unit Issue	Unit Price	Total Price
40	Off-Season Plant Opening First Day	0.00000	DAY		

Comm Code	Manufacturer	Specification	Model #
72141100			

Extended Description:
See Attached Pricing Page- Attachment A, For Actual Cost.

INVOICE TO	SHIP TO
------------	---------

VARIOUS AGENCY
LOCATIONS
AS INDICATED BY ORDER

VARIOUS AGENCY
LOCATIONS
AS INDICATED BY ORDER

No City WV
US

No City WV
US

Line	Comm Ln Desc	Qty	Unit Issue	Unit Price	Total Price
41	Off-Season Plant Opening Each Additional Day	0.00000	DAY		

Comm Code	Manufacturer	Specification	Model #
72141100			

Extended Description:
See Attached Pricing Page- Attachment A, For Actual Cost.

INVOICE TO	SHIP TO
------------	---------

VARIOUS AGENCY
LOCATIONS
AS INDICATED BY ORDER

VARIOUS AGENCY
LOCATIONS
AS INDICATED BY ORDER

No City WV
US

No City WV
US

Line	Comm Ln Desc	Qty	Unit Issue	Unit Price	Total Price
42	Asphalt Pavement Repair Daytime Mobilization	0.00000	LS		

Comm Code	Manufacturer	Specification	Model #
24000000			

Extended Description:
See Attached Pricing Page- Attachment A, For Actual Cost.

INVOICE TO	SHIP TO
------------	---------

VARIOUS AGENCY
LOCATIONS
AS INDICATED BY ORDER

VARIOUS AGENCY
LOCATIONS
AS INDICATED BY ORDER

No City WV
US

No City WV
US

Line	Comm Ln Desc	Qty	Unit Issue	Unit Price	Total Price
43	Asphalt Pavement Repair Nighttime Mobilization	0.00000	LS		

Comm Code	Manufacturer	Specification	Model #
24000000			

Extended Description:
See Attached Pricing Page- Attachment A, For Actual Cost.

INVOICE TO	SHIP TO
------------	---------

VARIOUS AGENCY
LOCATIONS
AS INDICATED BY ORDER

VARIOUS AGENCY
LOCATIONS
AS INDICATED BY ORDER

No City WV
US

No City WV
US

Line	Comm Ln Desc	Qty	Unit Issue	Unit Price	Total Price
44	Asphalt Pavement Repair On-Site Mobilization	0.00000	LS		

Comm Code	Manufacturer	Specification	Model #
24000000			

Extended Description:
See Attached Pricing Page- Attachment A, For Actual Cost.

SCHEDULE OF EVENTS

<u>Line</u>	<u>Event</u>	<u>Event Date</u>
1	TECHNICAL QUESTIONS DUE BY 10:00 AM EST	2025-01-15

	Document Phase	Document Description	Page 24
DOT2500000026	Final	Ditch, Pipe and Asphalt Repair and Maintenance by the Vendor	

ADDITIONAL TERMS AND CONDITIONS

See attached document(s) for additional Terms and Conditions



**State of West Virginia
Agency Request for Quote
Highways**

Proc Folder: 1593441		Reason for Modification:	
Doc Description: Ditch, Pipe and Asphalt Repair and Maintenance by the Vendor		Addendum 01	
Proc Type: Agency Master Agreement		To attach responses to questions from vendors and revised specifications.	
Date Issued	Solicitation Closes	Solicitation No	Version
2025-01-15	2025-01-23 10:30	ARFQ 0803 DOT2500000026	2

BID RECEIVING LOCATION

PROCUREMENT DIVISION
 DIVISION OF HIGHWAYS
 BLDG 6 RM 340A
 1900 KANAWHA BLVD E
 CHARLESTON WV 25305
 US

VENDOR

Vendor Customer Code: 000000160630
Vendor Name : Cast & Baker Corporation
Address : 2214 Washington Road
Street : 2214 Washington Road
City : Cannonsburg
State : Pennsylvania **Country :** USA **Zip :** 15317

Principal Contact :
Vendor Contact Phone: **Extension:**

FOR INFORMATION CONTACT THE BUYER
 Jeromie F Lanham
 304-720-7383
 jeromie.f.lanham@wv.gov

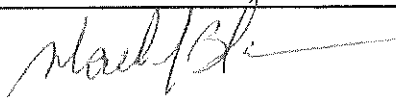
Vendor Signature X  **Michael J. Baker FEIN# 251428005** **DATE 1/20/25**

All offers subject to all terms and conditions contained in this solicitation

ADDITIONAL INFORMATION

ADDENDUM

ADDENDUM 1 IS ISSUED FOR THE FOLLOWING REASONS:

- 1. TO ATTACH RESPONSES TO QUESTIONS FROM VENDORS
- 2. TO ATTACH REVISED SPECIFICATIONS

NO OTHER CHANGES

INVOICE TO		SHIP TO	
VARIOUS AGENCY LOCATIONS AS INDICATED BY ORDER		VARIOUS AGENCY LOCATIONS AS INDICATED BY ORDER	
No City	WV	No City	WV
US		US	

Line	Comm Ln Desc	Qty	Unit Issue	Unit Price	Total Price
1	Pilot Truck and Driver	0.00000	DAY		

Comm Code	Manufacturer	Specification	Model #
46161500			

Extended Description:
See Attached Pricing Page- Attachment A, For Actual Cost.

INVOICE TO		SHIP TO	
VARIOUS AGENCY LOCATIONS AS INDICATED BY ORDER		VARIOUS AGENCY LOCATIONS AS INDICATED BY ORDER	
No City	WV	No City	WV
US		US	

Line	Comm Ln Desc	Qty	Unit Issue	Unit Price	Total Price
2	Traffic Control Devices	0.00000	UNIT		

Comm Code	Manufacturer	Specification	Model #
46161500			

Extended Description:
See Attached Pricing Page- Attachment A, For Actual Cost.

INVOICE TO		SHIP TO	
VARIOUS AGENCY LOCATIONS AS INDICATED BY ORDER		VARIOUS AGENCY LOCATIONS AS INDICATED BY ORDER	
No City	WV	No City	WV
US		US	

Line	Comm Ln Desc	Qty	Unit Issue	Unit Price	Total Price
3	Traffic Flagger	0.00000	HOUR		

Comm Code	Manufacturer	Specification	Model #
46161500			

Extended Description:
See Attached Pricing Page- Attachment A, For Actual Cost.

INVOICE TO		SHIP TO	
VARIOUS AGENCY LOCATIONS AS INDICATED BY ORDER		VARIOUS AGENCY LOCATIONS AS INDICATED BY ORDER	
No City	WV	No City	WV
US		US	

Line	Comm Ln Desc	Qty	Unit Issue	Unit Price	Total Price
4	Arrow Board	0.00000	DAY		

Comm Code	Manufacturer	Specification	Model #
46161500			

Extended Description:
See Attached Pricing Page- Attachment A, For Actual Cost.

INVOICE TO		SHIP TO	
VARIOUS AGENCY LOCATIONS AS INDICATED BY ORDER		VARIOUS AGENCY LOCATIONS AS INDICATED BY ORDER	
No City	WV	No City	WV
US		US	

Line	Comm Ln Desc	Qty	Unit Issue	Unit Price	Total Price
5	Ditching (Shoulder Mile)	0.00000	MILE		

Comm Code	Manufacturer	Specification	Model #
72141003			

Extended Description:
See Attached Pricing Page- Attachment A, For Actual Cost.

INVOICE TO		SHIP TO	
VARIOUS AGENCY LOCATIONS AS INDICATED BY ORDER		VARIOUS AGENCY LOCATIONS AS INDICATED BY ORDER	
No City	WV	No City	WV
US		US	

Line	Comm Ln Desc	Qty	Unit Issue	Unit Price	Total Price
6	Correcting Deep Ditches	0.00000	TON		

Comm Code	Manufacturer	Specification	Model #
72141003			

Extended Description:
See Attached Pricing Page- Attachment A, For Actual Cost.

INVOICE TO	SHIP TO
------------	---------

VARIOUS AGENCY
LOCATIONS
AS INDICATED BY ORDER

VARIOUS AGENCY
LOCATIONS
AS INDICATED BY ORDER

No City WV
US

No City WV
US

Line	Comm Ln Desc	Qty	Unit Issue	Unit Price	Total Price
7	Restoring Shoulders and Shoulder Stone	0.00000	TON		

Comm Code	Manufacturer	Specification	Model #
72141003			

Extended Description:
See Attached Pricing Page- Attachment A, For Actual Cost.

INVOICE TO	SHIP TO
------------	---------

VARIOUS AGENCY
LOCATIONS
AS INDICATED BY ORDER

VARIOUS AGENCY
LOCATIONS
AS INDICATED BY ORDER

No City WV
US

No City WV
US

Line	Comm Ln Desc	Qty	Unit Issue	Unit Price	Total Price
8	Shoulder Stone Placement	0.00000	TON		

Comm Code	Manufacturer	Specification	Model #
72141003			

Extended Description:
See Attached Pricing Page- Attachment A, For Actual Cost.

INVOICE TO	SHIP TO
------------	---------

VARIOUS AGENCY
LOCATIONS
AS INDICATED BY ORDER

VARIOUS AGENCY
LOCATIONS
AS INDICATED BY ORDER

No City WV
US

No City WV
US

Line	Comm Ln Desc	Qty	Unit Issue	Unit Price	Total Price
9	Ditching Haul by Vendor for Items 6, 7 & 8 (Ton Mile)	0.00000	MILE		

Comm Code	Manufacturer	Specification	Model #
72141003			

Extended Description:
See Attached Pricing Page- Attachment A, For Actual Cost.

INVOICE TO	SHIP TO
------------	---------

VARIOUS AGENCY
LOCATIONS
AS INDICATED BY ORDER

VARIOUS AGENCY
LOCATIONS
AS INDICATED BY ORDER

No City WV
US

No City WV
US

Line	Comm Ln Desc	Qty	Unit Issue	Unit Price	Total Price
10	Ditching Haul for Items 6, 7 & 8 Addl' Mile (Ton Mile)	0.00000	MILE		

Comm Code	Manufacturer	Specification	Model #
72141003			

Extended Description:
See Attached Pricing Page- Attachment A, For Actual Cost.

INVOICE TO		SHIP TO	
VARIOUS AGENCY LOCATIONS AS INDICATED BY ORDER		VARIOUS AGENCY LOCATIONS AS INDICATED BY ORDER	
No City	WV	No City	WV
US		US	

Line	Comm Ln Desc	Qty	Unit Issue	Unit Price	Total Price
11	Ditching Waste Haul by Vendor per Truck/ Driver	0.00000	HOUR		

Comm Code	Manufacturer	Specification	Model #
72153507			

Extended Description:
See Attached Pricing Page- Attachment A, For Actual Cost.

INVOICE TO		SHIP TO	
VARIOUS AGENCY LOCATIONS AS INDICATED BY ORDER		VARIOUS AGENCY LOCATIONS AS INDICATED BY ORDER	
No City	WV	No City	WV
US		US	

Line	Comm Ln Desc	Qty	Unit Issue	Unit Price	Total Price
12	Ditching Daytime Mobilization	0.00000	LS		

Comm Code	Manufacturer	Specification	Model #
24000000			

Extended Description:
See Attached Pricing Page- Attachment A, For Actual Cost.

INVOICE TO		SHIP TO	
VARIOUS AGENCY LOCATIONS AS INDICATED BY ORDER		VARIOUS AGENCY LOCATIONS AS INDICATED BY ORDER	
No City	WV	No City	WV
US		US	

Line	Comm Ln Desc	Qty	Unit Issue	Unit Price	Total Price
13	Ditching Nighttime Mobilization.	0.00000	LS		

Comm Code	Manufacturer	Specification	Model #
24000000			

Extended Description:
See Attached Pricing Page- Attachment A, For Actual Cost.

INVOICE TO		SHIP TO	
VARIOUS AGENCY LOCATIONS AS INDICATED BY ORDER		VARIOUS AGENCY LOCATIONS AS INDICATED BY ORDER	
No City	WV	No City	WV
US		US	

Line	Comm Ln Desc	Qty	Unit Issue	Unit Price	Total Price
14	Ditching On-Site Mobilization	0.00000	LS		

Comm Code	Manufacturer	Specification	Model #
24000000			

Extended Description:
See Attached Pricing Page- Attachment A, For Actual Cost.

INVOICE TO	SHIP TO
------------	---------

VARIOUS AGENCY
LOCATIONS
AS INDICATED BY ORDER

VARIOUS AGENCY
LOCATIONS
AS INDICATED BY ORDER

No City WV
US

No City WV
US

Line	Comm Ln Desc	Qty	Unit Issue	Unit Price	Total Price
15	15" Type F Trench	0.00000	LF		

Comm Code	Manufacturer	Specification	Model #
72141100			

Extended Description:
See Attached Pricing Page- Attachment A, For Actual Cost.

INVOICE TO	SHIP TO
------------	---------

VARIOUS AGENCY
LOCATIONS
AS INDICATED BY ORDER

VARIOUS AGENCY
LOCATIONS
AS INDICATED BY ORDER

No City WV
US

No City WV
US

Line	Comm Ln Desc	Qty	Unit Issue	Unit Price	Total Price
16	18" Type F Trench	0.00000	LF		

Comm Code	Manufacturer	Specification	Model #
72141100			

Extended Description:
See Attached Pricing Page- Attachment A, For Actual Cost.

INVOICE TO		SHIP TO	
VARIOUS AGENCY LOCATIONS AS INDICATED BY ORDER		VARIOUS AGENCY LOCATIONS AS INDICATED BY ORDER	
No City	WV	No City	WV
US		US	

Line	Comm Ln Desc	Qty	Unit Issue	Unit Price	Total Price
17	24" Type F Trench	0.00000	LF		

Comm Code	Manufacturer	Specification	Model #
72141100			

Extended Description:
See Attached Pricing Page- Attachment A, For Actual Cost.

INVOICE TO		SHIP TO	
VARIOUS AGENCY LOCATIONS AS INDICATED BY ORDER		VARIOUS AGENCY LOCATIONS AS INDICATED BY ORDER	
No City	WV	No City	WV
US		US	

Line	Comm Ln Desc	Qty	Unit Issue	Unit Price	Total Price
18	30" Type F Trench	0.00000	LF		

Comm Code	Manufacturer	Specification	Model #
72141100			

Extended Description:
See Attached Pricing Page- Attachment A, For Actual Cost.

INVOICE TO	SHIP TO
------------	---------

VARIOUS AGENCY
LOCATIONS
AS INDICATED BY ORDER

VARIOUS AGENCY
LOCATIONS
AS INDICATED BY ORDER

No City WV
US

No City WV
US

Line	Comm Ln Desc	Qty	Unit Issue	Unit Price	Total Price
19	36" Type F Trench	0.00000	LF		

Comm Code	Manufacturer	Specification	Model #
72141100			

Extended Description:
See Attached Pricing Page- Attachment A, For Actual Cost.

INVOICE TO	SHIP TO
------------	---------

VARIOUS AGENCY
LOCATIONS
AS INDICATED BY ORDER

VARIOUS AGENCY
LOCATIONS
AS INDICATED BY ORDER

No City WV
US

No City WV
US

Line	Comm Ln Desc	Qty	Unit Issue	Unit Price	Total Price
20	42" Type F Trench	0.00000	LF		

Comm Code	Manufacturer	Specification	Model #
72141100			

Extended Description:
See Attached Pricing Page- Attachment A, For Actual Cost.

INVOICE TO	SHIP TO
------------	---------

VARIOUS AGENCY
LOCATIONS
AS INDICATED BY ORDER

VARIOUS AGENCY
LOCATIONS
AS INDICATED BY ORDER

No City WV
US

No City WV
US

Line	Comm Ln Desc	Qty	Unit Issue	Unit Price	Total Price
21	48" Type F Trench	0.00000	LF		

Comm Code	Manufacturer	Specification	Model #
72141100			

Extended Description:
See Attached Pricing Page- Attachment A, For Actual Cost.

INVOICE TO	SHIP TO
------------	---------

VARIOUS AGENCY
LOCATIONS
AS INDICATED BY ORDER

VARIOUS AGENCY
LOCATIONS
AS INDICATED BY ORDER

No City WV
US

No City WV
US

Line	Comm Ln Desc	Qty	Unit Issue	Unit Price	Total Price
22	54" Type F Trench	0.00000	LF		

Comm Code	Manufacturer	Specification	Model #
72141100			

Extended Description:
See Attached Pricing Page- Attachment A, For Actual Cost.

INVOICE TO		SHIP TO	
VARIOUS AGENCY LOCATIONS AS INDICATED BY ORDER		VARIOUS AGENCY LOCATIONS AS INDICATED BY ORDER	
No City	WV	No City	WV
US		US	

Line	Comm Ln Desc	Qty	Unit Issue	Unit Price	Total Price
23	60" Type f Trench	0.00000	LF		

Comm Code	Manufacturer	Specification	Model #
72141100			

Extended Description:
See Attached Pricing Page- Attachment A, For Actual Cost.

INVOICE TO		SHIP TO	
VARIOUS AGENCY LOCATIONS AS INDICATED BY ORDER		VARIOUS AGENCY LOCATIONS AS INDICATED BY ORDER	
No City	WV	No City	WV
US		US	

Line	Comm Ln Desc	Qty	Unit Issue	Unit Price	Total Price
24	Pipe Repair/Replacement backfill for F Trench (mat+first5mi)	0.00000	CY		

Comm Code	Manufacturer	Specification	Model #
72141100			

Extended Description:
See Attached Pricing Page- Attachment A, For Actual Cost.

INVOICE TO		SHIP TO	
VARIOUS AGENCY LOCATIONS AS INDICATED BY ORDER		VARIOUS AGENCY LOCATIONS AS INDICATED BY ORDER	
No City	WV	No City	WV
US		US	

Line	Comm Ln Desc	Qty	Unit Issue	Unit Price	Total Price
25	Additional Haul per truck load over 5mi, Backfill F Trench	0.00000	MILE		

Comm Code	Manufacturer	Specification	Model #
72141100			

Extended Description:
See Attached Pricing Page- Attachment A, For Actual Cost.

INVOICE TO		SHIP TO	
VARIOUS AGENCY LOCATIONS AS INDICATED BY ORDER		VARIOUS AGENCY LOCATIONS AS INDICATED BY ORDER	
No City	WV	No City	WV
US		US	

Line	Comm Ln Desc	Qty	Unit Issue	Unit Price	Total Price
26	Safe Access & Egress Surcharge depth of 5ft to 10ft	0.00000	LS		

Comm Code	Manufacturer	Specification	Model #
72141100			

Extended Description:
See Attached Pricing Page- Attachment A, For Actual Cost.

INVOICE TO	SHIP TO
------------	---------

VARIOUS AGENCY
LOCATIONS
AS INDICATED BY ORDER

VARIOUS AGENCY
LOCATIONS
AS INDICATED BY ORDER

No City WV
US

No City WV
US

Line	Comm Ln Desc	Qty	Unit Issue	Unit Price	Total Price
27	Safe Access & Egress Surcharge depth of 10ft to 15ft	0.00000	LS		

Comm Code	Manufacturer	Specification	Model #
72141100			

Extended Description:
See Attached Pricing Page- Attachment A, For Actual Cost.

INVOICE TO	SHIP TO
------------	---------

VARIOUS AGENCY
LOCATIONS
AS INDICATED BY ORDER

VARIOUS AGENCY
LOCATIONS
AS INDICATED BY ORDER

No City WV
US

No City WV
US

Line	Comm Ln Desc	Qty	Unit Issue	Unit Price	Total Price
28	Safe Access & Egress Surcharge depth 15ft to 20ft	0.00000	LS		

Comm Code	Manufacturer	Specification	Model #
72141100			

Extended Description:
See Attached Pricing Page- Attachment A, For Actual Cost.

INVOICE TO		SHIP TO	
VARIOUS AGENCY LOCATIONS AS INDICATED BY ORDER		VARIOUS AGENCY LOCATIONS AS INDICATED BY ORDER	
No City	WV	No City	WV
US		US	

Line	Comm Ln Desc	Qty	Unit Issue	Unit Price	Total Price
29	Pipe Repair/Replacement Waste Haul by Vendor -truck/driver	0.00000	HOUR		

Comm Code	Manufacturer	Specification	Model #
72153507			

Extended Description:
See Attached Pricing Page- Attachment A, For Actual Cost.

INVOICE TO		SHIP TO	
VARIOUS AGENCY LOCATIONS AS INDICATED BY ORDER		VARIOUS AGENCY LOCATIONS AS INDICATED BY ORDER	
No City	WV	No City	WV
US		US	

Line	Comm Ln Desc	Qty	Unit Issue	Unit Price	Total Price
30	Pipe Repair/Replacement Daytime Mobilization	0.00000	LS		

Comm Code	Manufacturer	Specification	Model #
24000000			

Extended Description:
See Attached Pricing Page- Attachment A, For Actual Cost.

INVOICE TO		SHIP TO	
VARIOUS AGENCY LOCATIONS AS INDICATED BY ORDER		VARIOUS AGENCY LOCATIONS AS INDICATED BY ORDER	
No City	WV	No City	WV
US		US	

Line	Comm Ln Desc	Qty	Unit Issue	Unit Price	Total Price
31	Pipe Repair/Replacement Nighttime Mobilization	0.00000	LS		

Comm Code	Manufacturer	Specification	Model #
24000000			

Extended Description:
See Attached Pricing Page- Attachment A, For Actual Cost.

INVOICE TO		SHIP TO	
VARIOUS AGENCY LOCATIONS AS INDICATED BY ORDER		VARIOUS AGENCY LOCATIONS AS INDICATED BY ORDER	
No City	WV	No City	WV
US		US	

Line	Comm Ln Desc	Qty	Unit Issue	Unit Price	Total Price
32	Pipe Repair/Replacement On-Site Mobilization	0.00000	LS		

Comm Code	Manufacturer	Specification	Model #
24000000			

Extended Description:
See Attached Pricing Page- Attachment A, For Actual Cost.

INVOICE TO	SHIP TO
------------	---------

VARIOUS AGENCY
LOCATIONS
AS INDICATED BY ORDER

VARIOUS AGENCY
LOCATIONS
AS INDICATED BY ORDER

No City WV
US

No City WV
US

Line	Comm Ln Desc	Qty	Unit Issue	Unit Price	Total Price
33	Pothole Repair (Per Project Size Range)	0.00000	MILE		

Comm Code	Manufacturer	Specification	Model #
72141100			

Extended Description:
See Attached Pricing Page- Attachment A, For Actual Cost.

INVOICE TO	SHIP TO
------------	---------

VARIOUS AGENCY
LOCATIONS
AS INDICATED BY ORDER

VARIOUS AGENCY
LOCATIONS
AS INDICATED BY ORDER

No City WV
US

No City WV
US

Line	Comm Ln Desc	Qty	Unit Issue	Unit Price	Total Price
34	Base Failure Repair, Asphalt (Per Project Size Range)	0.00000	MILE		

Comm Code	Manufacturer	Specification	Model #
72141100			

Extended Description:
See Attached Pricing Page- Attachment A, For Actual Cost.

INVOICE TO	SHIP TO
------------	---------

VARIOUS AGENCY
LOCATIONS
AS INDICATED BY ORDER

VARIOUS AGENCY
LOCATIONS
AS INDICATED BY ORDER

No City WV
US

No City WV
US

Line	Comm Ln Desc	Qty	Unit Issue	Unit Price	Total Price
35	Base Failure Repair, Stone (Per Project Size Range)	0.00000	MILE		

Comm Code	Manufacturer	Specification	Model #
72141100			

Extended Description:
See Attached Pricing Page- Attachment A, For Actual Cost.

INVOICE TO	SHIP TO
------------	---------

VARIOUS AGENCY
LOCATIONS
AS INDICATED BY ORDER

VARIOUS AGENCY
LOCATIONS
AS INDICATED BY ORDER

No City WV
US

No City WV
US

Line	Comm Ln Desc	Qty	Unit Issue	Unit Price	Total Price
36	Edge Failure Repair (Per Project Size Range)	0.00000	MILE		

Comm Code	Manufacturer	Specification	Model #
72141100			

Extended Description:
See Attached Pricing Page- Attachment A, For Actual Cost.

INVOICE TO		SHIP TO	
VARIOUS AGENCY LOCATIONS AS INDICATED BY ORDER		VARIOUS AGENCY LOCATIONS AS INDICATED BY ORDER	
No City	WV	No City	WV
US		US	

Line	Comm Ln Desc	Qty	Unit Issue	Unit Price	Total Price
37	Haul by Vendor First Ton Mile	0.00000	MILE		

Comm Code	Manufacturer	Specification	Model #
72141100			

Extended Description:
See Attached Pricing Page- Attachment A, For Actual Cost.

INVOICE TO		SHIP TO	
VARIOUS AGENCY LOCATIONS AS INDICATED BY ORDER		VARIOUS AGENCY LOCATIONS AS INDICATED BY ORDER	
No City	WV	No City	WV
US		US	

Line	Comm Ln Desc	Qty	Unit Issue	Unit Price	Total Price
38	Haul by Vendor Each Additional Mile (Ton Mile)	0.00000	MILE		

Comm Code	Manufacturer	Specification	Model #
72141100			

Extended Description:
See Attached Pricing Page- Attachment A, For Actual Cost.

INVOICE TO	SHIP TO
------------	---------

VARIOUS AGENCY
LOCATIONS
AS INDICATED BY ORDER

VARIOUS AGENCY
LOCATIONS
AS INDICATED BY ORDER

No City WV
US

No City WV
US

Line	Comm Ln Desc	Qty	Unit Issue	Unit Price	Total Price
39	Waste Haul by Vendor per truck/driver	0.00000	HOUR		

Comm Code	Manufacturer	Specification	Model #
72153507			

Extended Description:
See Attached Pricing Page- Attachment A, For Actual Cost.

INVOICE TO	SHIP TO
------------	---------

VARIOUS AGENCY
LOCATIONS
AS INDICATED BY ORDER

VARIOUS AGENCY
LOCATIONS
AS INDICATED BY ORDER

No City WV
US

No City WV
US

Line	Comm Ln Desc	Qty	Unit Issue	Unit Price	Total Price
40	Off-Season Plant Opening First Day	0.00000	DAY		

Comm Code	Manufacturer	Specification	Model #
72141100			

Extended Description:
See Attached Pricing Page- Attachment A, For Actual Cost.

INVOICE TO	SHIP TO
------------	---------

VARIOUS AGENCY
LOCATIONS
AS INDICATED BY ORDER

VARIOUS AGENCY
LOCATIONS
AS INDICATED BY ORDER

No City WV
US

No City WV
US

Line	Comm Ln Desc	Qty	Unit Issue	Unit Price	Total Price
41	Off-Season Plant Opening Each Additional Day	0.00000	DAY		

Comm Code	Manufacturer	Specification	Model #
72141100			

Extended Description:
See Attached Pricing Page- Attachment A, For Actual Cost.

INVOICE TO	SHIP TO
------------	---------

VARIOUS AGENCY
LOCATIONS
AS INDICATED BY ORDER

VARIOUS AGENCY
LOCATIONS
AS INDICATED BY ORDER

No City WV
US

No City WV
US

Line	Comm Ln Desc	Qty	Unit Issue	Unit Price	Total Price
42	Asphalt Pavement Repair Daytime Mobilization	0.00000	LS		

Comm Code	Manufacturer	Specification	Model #
24000000			

Extended Description:
See Attached Pricing Page- Attachment A, For Actual Cost.

INVOICE TO		SHIP TO	
VARIOUS AGENCY LOCATIONS AS INDICATED BY ORDER		VARIOUS AGENCY LOCATIONS AS INDICATED BY ORDER	
No City	WV	No City	WV
US		US	

Line	Comm Ln Desc	Qty	Unit Issue	Unit Price	Total Price
43	Asphalt Pavement Repair Nighttime Mobilization	0.00000	LS		

Comm Code	Manufacturer	Specification	Model #
24000000			

Extended Description:
See Attached Pricing Page- Attachment A, For Actual Cost.

INVOICE TO		SHIP TO	
VARIOUS AGENCY LOCATIONS AS INDICATED BY ORDER		VARIOUS AGENCY LOCATIONS AS INDICATED BY ORDER	
No City	WV	No City	WV
US		US	

Line	Comm Ln Desc	Qty	Unit Issue	Unit Price	Total Price
44	Asphalt Pavement Repair On-Site Mobilization	0.00000	LS		

Comm Code	Manufacturer	Specification	Model #
24000000			

Extended Description:
See Attached Pricing Page- Attachment A, For Actual Cost.

SCHEDULE OF EVENTS		
Line	Event	Event Date
1	TECHNICAL QUESTIONS DUE BY 10:00 AM EST	2025-01-15

SOLICITATION NUMBER: ARFQ DOT2500000026

Addendum Number: 1

The purpose of this addendum is to modify the solicitation identified as (“Solicitation”) to reflect the change(s) identified and described below.

Applicable Addendum Category:

- Modify bid opening date and time
- Modify specifications of product or service being sought
- Attachment of vendor questions and responses
- Attachment of pre-bid sign-in sheet
- Correction of error
- Other

Description of Modification to Solicitation:

ADDENDUM 1 IS ISSUED FOR THE FOLLOWING REASONS:

1. TO ATTACH RESPONSES TO QUESTIONS FROM VENDORS
2. TO ATTACHED REVISED SPECIFICATIONS.

NO OTHER CHANGES

+

Additional Documentation: Documentation related to this Addendum (if any) has been included herewith as Attachment A and is specifically incorporated herein by reference.

Terms and Conditions:

1. All provisions of the Solicitation and other addenda not modified herein shall remain in full force and effect.
2. Vendor should acknowledge receipt of all addenda issued for this Solicitation by completing an Addendum Acknowledgment, a copy of which is included herewith. Failure to acknowledge addenda may result in bid disqualification. The addendum acknowledgement should be submitted with the bid to expedite document processing.

ATTACHMENT A

ARFQ DOT2500000026 Ditch, Pipe and Asphalt Repair and Maintenance by Vendor

Responses to Questions from Vendors

Question 1

How long will the Contractor have upon notice of the project award to mobilize?

Response 1

Once an Agency Delivery Order has been issued to the vendor on a specific project, as per Section 6.1, the vendor will have five (5) days to respond to either accept or reject the work. If accepted, section 6.1.1 allows the WVDOH to negotiate the dates.

Section 5.2.1 states "Lead Time: The WVDOH should plan accordingly to allow the Contractor a minimum of 14 calendar days prior to the date of the agreed upon start date on the ADO to allow Vendor to mobilize and begin work."

Question 2

What is the time allotment for materials procurement, specifically piping?

Response 2

The WVDOH is responsible for the procurement of pipe, not the vendor, though the vendor may be required to pick up the pipe from WVDOH and deliver it to the project site.

Section 3.2.3 states: "The WVDOH shall provide the pipe and pipe hardware required for project. The ADO will indicate whether the Vendor or the WVDOH is responsible for picking up pipe materials and transporting them to the project site. Pick Up of project materials from WVDOH shall be incidental to mobilization."

Section 3.2.3.1 states: "Pipe Repair and Replacement, Contract Items 15 thru 23, shall include all labor, equipment, and materials, excluding pipe and pipe hardware and backfill material, excluding CLSM for F Trenches, in the unit bid price."

Question 3

Can the Contractor assume the installation of all pipes shall be the open-cut method?

Response 3

While this contract does not dictate the means and methods, work shall be carried out in accordance with Standard Specs 207, and 604. Pipe Repair & Replacement shall meet the requirements of the Standard Detail for Repaving Pipe Trenches F, EXH 1, Page 5, or as identified by the Delivery Order or the WVDOH District Engineer.

Question 4

Items 33-48 show a Unit of Measure as Miles. Will the item be paid per mile for each "size of project per mile", not by the SY? In essence, the WVDOT will be paying the same price for 2 SY in a mile as they would pay for 50 SY in the same mile?

Response 4

For Contract Items 33-48, Vendor should provide their bid price per mile, for projects of various sizes. Yes, the WVDOT would be paying the same price for 2 SY in a mile as they would pay for 50 SY in the same mile in your example.

Question 5

Are items 41- 44 Base Failure Repair, Stone utilized in the performance of items 37-40 Base Failure Repair, Asphalt?

Response 5

Yes, Contract Items 41-44 Base Failure Repair would be utilized in the performance of Contract Items 37-40, but are incidental for Contract Items 37-40 and included within the bid price, as stated in Section 3.2.4.2: "Base Failure bids shall include all labor, equipment, and materials to complete Base Failure Repair..."

Question 6

3.2.4.3 has a NOTE that "Varies" shall mean for every 3 inches of asphalt, there shall be 6 inches of stone, unless specified otherwise by the Engineer. The Base Failure Repair Detail states that the aggregate is estimated at 6". What should we use in estimating to establish our pricing?

Response 6

Vendor should use the following when estimating: "For every 3 inches of asphalt, there shall be 6 inches of stone, unless specified otherwise by the Engineer." Additional language has been added to the NOTE for situations that significantly exceed the asphalt and/or stone requirements of these sections.

Question 7

Was there any work orders issued utilizing the 2023 "Ditch, Pipe and Asphalt Repair Maintenance by the Vendor" contracts?

Response 7

Yes, Districts 2, 4 and 6 placed orders under the current contract for Ditching Maintenance & Repair and Pipe Repair & Replacement, and related traffic control. To the best of our knowledge no orders were placed for Asphalt Pavement Repair under the current contract.

REQUEST FOR QUOTATION
Ditch, Pipe, and Asphalt Repair and Maintenance by the Vendor

SPECIFICATIONS

1. **PURPOSE AND SCOPE:** The West Virginia Division of Highways is soliciting bids to establish an open-end contract for roadway maintenance and repair projects at various project sites throughout the State of West Virginia, to include all materials, equipment, and labor by the Vendor to perform ditch maintenance and repair, pipe repair and replacement, and asphalt pavement patching and repair. This contract is intended to supplement the WVDOH work force for such maintenance work.

2. **DEFINITIONS:** The terms listed below shall have the following meanings assigned to them throughout and for the purpose of this Solicitation. Additional definitions can be found in Section 2 of the General Terms and Conditions.
 - 2.1 **“AASHTO”** - The American Association of State Highway and Transportation Officials is a standard setting body which publishes specifications, test protocols, and guidelines that are used in highway design and construction throughout the United States. Reference: www.transportation.org.

 - 2.2 **“ADO” and “Agency Delivery Order”** - A written order entered by WVDOH personnel in the wvOASIS financial system against a master agreement, authorizing quantities of commodities and/or services to be delivered in accordance with all terms, conditions, and prices stipulated in the original contract.

 - 2.3 **“Approved Source,” “Approved Plant,” “Approved Product,” or “Approved Vendor”** - terms referring to the Approved Product Lists (APL) of certified manufacturers and/or products that meet acceptable levels of quality as determined by WVDOH Materials Control, Soils and Testing Division (MCS&T). These lists are updated periodically, and it is the Vendors responsibility to refer to the MCS&T website to ensure compliance. Reference: https://transportation.wv.gov/highways/mcst/Pages/APL_By_Number.aspx.

 - 2.4 **“Asphalt,” “Hot Mix Asphalt” and “HMA”** - Terms used interchangeably for asphalt.

 - 2.5 **“Contract Item”** - The list of items available for Vendor to provide pricing as identified in Section 3.2 of this Solicitation and referenced throughout.

 - 2.6 **“Emergency Work”** – Work or orders required to be done without delay owing to circumstances for which the WVDOH could not have reasonably expected and has been designated as such by a representative of the WVDOH.

REQUEST FOR QUOTATION
Ditch, Pipe, and Asphalt Repair and Maintenance by the Vendor

- 2.7 **“EPA”** - Environmental Protection Agency and the WV Department of Environmental Protection and references the Federal, State, and Local levels of government. www.epa.gov and www.dep.wv.gov.
- 2.8 **“Exhibit 1” and “EXH 1”** – Standard Details relevant to work under this contract. Details are excerpts of the West Virginia Division of Highways Engineering Division Typical Sections and Related Details, 2019 edition.
- 2.9 **“FOB” or “Free on Board”** - Indicates that the price for goods includes delivery at the Vendor’s expense to a specified point, and that the Vendor retains liability for loss or damage until the goods are delivered.
- 2.10 **“Liquidated Damages”** - Monetary compensation due from the Vendor in the event the Vendor’s performance falls short of contractual stipulation or breaches the contract. Delays in the delivery of goods and/or services or quality failures or corrections by the Vendor may result in the Agency assessing charges for such deficiencies per these contract Specifications, the Standard Specs Section 108.7, as amended, and calculated from the table posted in Section 6.4.1 of these Specifications.
- 2.11 **“MCS&T”** - The WVDOH Materials Control, Soil and Testing Division, who perform all procedures necessary with sampling, testing, reporting and inspection of products and materials to maintain a reliable quality assurance system. Reference: <http://www.transportation.wv.gov/highways/mcst/Pages/default.aspx>.
- 2.12 **“MP”** - Material Procedures, as amended, issued by the WVDOH Materials Control, Soils and Testing Division. The MP numbers referenced throughout these Contract Specifications are available by MP number at: <https://transportation.wv.gov/highways/mcst/Pages/WVDOH-Materials-Procedures.aspx>
- 2.13 **“Pricing Pages,” “Attachment A,” and “ATT A”** - The schedule of prices attached hereto as Attachment A (ATT A) and used to evaluate Solicitation responses.
- 2.14 **“Solicitation”** - The official notice of an opportunity to supply the State with goods or services.
- 2.15 **“Standard Specs”** - Used throughout this solicitation means the West Virginia Department of Transportation, Division of Highways Standard Specifications, Roads and Bridges, most recent edition, as modified or amended by all subsequent Supplemental Specifications.

REQUEST FOR QUOTATION
Ditch, Pipe, and Asphalt Repair and Maintenance by the Vendor

- 2.16 **“Vendor” or “Contractor”**- Interchangeably used throughout this Solicitation and in any cited Sections of the West Virginia Department of Transportation, Division of Highways Standard Specifications, Roads and Bridges, adopted latest Standard Specs edition, as amended, including any Supplementals and refers to any entity submitting a bid in response to the Solicitation, the entity that has been selected as the lowest responsible bidder, or the entity that has been awarded the Contract, as context requires.
- 2.17 **“WVDOH” or “Agency”** - Interchangeable terms for the West Virginia Division of Highways.

3. GENERAL REQUIREMENTS:

- 3.1 **Standard Specifications Roads and Bridges:** The following Standard Specs Sections shall apply, as applicable, to the administration of this contract: 101, 102, 103, 104, 105, 106, 107, 108, 109, and 110, as amended.

Materials, equipment, and performance of this contract shall conform to, but are not limited to, the requirements of Sections 207, 211, 219, 229, 240, 307, 401, 408, 507, 604 and 636, as amended.

Free electronic copies of the Standard Specs and Supplementals are available at: <https://transportation.wv.gov/highways/TechnicalSupport/specifications/Pages/default.aspx>. Hard copies of these publications may be purchased from the Technical Support Division by completing the Specification Order Form provided within the website.

- 3.2 **Contract Items and Mandatory Requirements:** Vendor shall provide Agency with the Contract Items listed below on an open-end and continuing basis. Contract Items are listed on the Pricing Pages which hereafter shall be referred to as “ATT A.” Contract Items must meet or exceed the mandatory requirements as shown below.

The project start date and completion date should be noted on the ADO. Prior to the beginning of any work, the Vendor shall contact Miss Utility of WV via the WV811 app or by dialing 811 at least two business days prior to the ADO’s project start date to allow the utility to identify and mark their facilities. A reference number will be provided to the Vendor to serve as proof of the contact. The Vendor shall retain this reference number with the ADO for possible future need or justification.

Guardrails are the responsibility of WVDOH. WVDOH forces shall perform any guardrail removal, repair, or replacement work needed at project sites. Erosion Control will be the responsibility of WVDOH.

REQUEST FOR QUOTATION
Ditch, Pipe, and Asphalt Repair and Maintenance by the Vendor

3.2.1 Traffic Control, Contract Items 1 thru 4. While undergoing improvement, the project site shall be kept open to traffic in such condition that both local and through traffic will be adequately and safely accommodated. All improvement operations shall be scheduled by the Vendor to keep traffic delay to a minimum.

3.2.1.1 Vendor shall provide traffic control for all projects covered by this contract, unless otherwise instructed by the WVDOH Engineer. Traffic shall be maintained by the Vendor in accordance with Standard Specs Section 636. All traffic control devices shall be fabricated and installed according to the “Manual on Temporary Traffic Control for Streets and Highways”, latest version, published by the Agency at <https://transportation.wv.gov/highways/traffic/Documents/TemporaryTrafficControlManual2006.pdf>. The type of construction operation being performed will dictate the traffic control case (scheme) to be used as outlined in this manual and as called for on the Plans. The Vendor shall submit their Traffic Control Plans to the WVDOH Engineer or their designee with their written Project Acceptance/ ADO Acknowledgement, as required in section 6.1 of these Contract Specifications. Vendors Traffic Control Plans are subject to WVDOH approval.

3.2.1.2 The cost for Bridging/Plating material used to maintain traffic at the end of a work shift shall be incidental to the project and shall be at no additional cost to the WVDOH.

3.2.1.3 The roadway shall be free of dirt, debris, and excessive dust and opened to the traveling public at the end of each shift with no additional cost to the WVDOH.

3.2.1.4 If the vendor performs a combination of services under this contract at the same project location, on the same day, they may only charge for traffic control services once.

3.2.2 Ditching Maintenance & Repair, Contract Items 5 thru 14, shall be used for trimming, sloping and cleaning to open all inlets and outlets identified on an ADO. Work shall be carried out in accordance with Standard Specs 207, 211, and 229.

Ditches shall be inspected for damage prior to the start of work. If damage is discovered, this shall be reported to the WVDOH District Engineer or designee for further instructions. Ditches shall be cleared of

REQUEST FOR QUOTATION
Ditch, Pipe, and Asphalt Repair and Maintenance by the Vendor

all obstructions, such as, but not limited to, trees, branches, and boulders, to allow the ditch flowline of water to be led to a suitable place of discharge.

All debris/obstacles removed from a ditch shall be disposed of by the Vendor in accordance with EPA waste disposal laws and regulations. Debris/obstacles that can be recycled/mulched/crushed may only be used to complete the project with the prior approval by the WVDOH District Engineer or designee.

All labor, equipment and material to complete ditching work shall be included in the unit bid prices. Any traffic control required shall be charged per Section 3.2.1 of these Contract Specifications. Acceptance Criteria shall be per Section 3.2.6.

3.2.2.1 Ditching, Contract Item 5, shall meet the depth and width requirements of the Standard Detail for Shoulder and Ditches, EXH 1, Page 1, as directed by the Delivery Order and the WVDOH District Engineer or designee and shall be bid per shoulder mile.

3.2.2.2 Correcting Deep Ditches, Contract Item 6, shall meet the Rock Borrow Excavation requirements of the Standard Detail for Correcting Deep Ditches, EXH 1, Page 2, or as directed by the Delivery Order and the WVDOH District Engineer or designee and shall be bid per ton.

3.2.2.3 Restoring Shoulders, Contract Item 7, shall meet the requirements of the Standard Detail for Restoring Shoulders for Guardrail & Sliver Fills, EXH 1, Page 3, or as directed by the Delivery Order and the WVDOH District Engineer or designee and shall be bid per ton.

3.2.2.4 Shoulder Stone Placement, Contract Item 8, shall meet the requirements of the Standard Detail for Shoulder Reconstruction, EXH 1, Page 4, or as directed by the Delivery Order and the WVDOH District Engineer or designee and shall be bid per ton.

3.2.2.5 Ditching Haul of Materials by Vendor, Contract Items 9 & 10, will only be requested in combination with other awarded ditching items. The WVDOH Engineer or their designee shall calculate mileage distance utilizing "Google Maps" or a similar source for routing from the Vendor's nearest Base of Operations location, as identified on ATT A, to the mid-point of the Agency's project site.

REQUEST FOR QUOTATION
Ditch, Pipe, and Asphalt Repair and Maintenance by the Vendor

The Agency, at its own discretion, will determine the route to be taken due to bridge and/or road restrictions which shall have acceptable load limits for both roads and bridges.

3.2.2.6 Waste Haul for Ditching, Contract Item 11, shall be used for the hauling of/disposal of debris and any material unsuitable for backfill from the project site to a WVDOH approved waste location. This location shall be within proximity to the project site and will be provided on the ADO. The Vendor shall bid an hourly rate per truck/driver.

3.2.3 Pipe Repair & Replacement, Contract Items 15 thru 32. Repair & replacement pipe shall be installed to match the existing inlet and outlet invert elevations unless otherwise directed by the WVDOH District Engineer or designee. The minimum and maximum depth of cover shall be as per the manufacturer's recommendation and shall be no less than 12 inches, unless specified otherwise by the WVDOH Engineer or their designee on the ADO. Work shall be carried out in accordance with Standard Specs 207, and 604. The vendor shall be responsible for the removal and proper disposal of old pipe at no additional charge.

Prior to the issuance of a Delivery Order for Pipe Repair/Replacement, the WVDOH District Engineer or designee shall have all required Environmental Permits in place. The WVDOH shall provide the pipe and pipe hardware required for project. The ADO will indicate whether the Vendor or the WVDOH is responsible for picking up pipe materials and transporting them to the project site. Pick Up of project materials from WVDOH shall be incidental to mobilization. Erosion Control will be the responsibility of the WVDOH. Any traffic control required shall be charged per Section 3.2.1 of these Contract Specifications. Acceptance Criteria shall be per Section 3.2.6.

3.2.3.1 Pipe Repair and Replacement, Contract Items 15 thru 23, shall include all labor, equipment, and materials, excluding pipe and pipe hardware and backfill material, excluding CLSM for F Trenches, in the unit bid price. Bid price shall be per linear foot.

Pipe Repair & Replacement shall meet the requirements of the Standard Detail for Repaving Pipe Trenches F, EXH 1, Page 5, or as identified by the Delivery Order or the WVDOH District Engineer or designee and shall be bid per linear foot.

3.2.3.2 Pipe Repair/Replacement Backfill for F Trench, Contract Item 24, for shall bid CLSM backfill by the cubic yard. The cost of

REQUEST FOR QUOTATION
Ditch, Pipe, and Asphalt Repair and Maintenance by the Vendor

materials per cubic yard shall include haul up to five (5) miles within the bid price.

When replacing gravel surfaces, Type F Trench backfill shall be no less than 12 inches below the surface.

3.2.3.3 Additional Haul of Backfill for F Trench, Contract Item 25:

Additional Haul is to be charged for distances exceeding five (5) miles and is to only be used with Contract Item 24. Haul shall be one way and measured per loaded mile from Vendor's source plant to the WVDOH project site, for the portion of the haul which exceeds five (5) miles. Vendor shall use suitable routes selected by the Agency District Engineer. All such chosen routes shall have acceptable load limits for both roads and bridges.

3.2.3.4 Safe Access and Egress Surcharge, Contract Items 26-28.

To meet OSHA standards required for trenching, sloping, shoring, use of shielding protections or other types of supports to prevent soil cave-ins, after a depth of 4-foot, the Vendor may add a surcharge to the project. If the WVDOH District Engineer or designee did not include this surcharge in their initial estimated cost for the project, the Vendor shall advise the WVDOH District Engineer or designee as soon as possible. The WVDOH District Engineer or designee may agree or disagree with the Vendor's request; the decision of the District Engineer shall be final.

3.2.3.5 Waste Haul for Pipe Repair/Replacement, Contract Item 29,

shall be used for the hauling of/disposal of debris and any material unsuitable for backfill from the project site to a WVDOH approved waste location. This location shall be within proximity to the project site and will be provided on the Delivery Order. The Vendor shall bid an hourly rate per truck/driver.

3.2.4 Asphalt Pavement Repair, Contract Items 33 thru 56: Pothole Repair, Base Failure Repair, or Edge Failure Repair shall be requested to correct potholes, edge failures, upheavals, settlements, cracking, raveling and base failures to prevent further deterioration, eliminate safety hazards, improve riding quality and restore proper drainage as identified on an ADO.

Repairing an existing pavement shall consist of squaring up the repair area, removing damaged material to a depth, per the Standard Detail, directed by the WVDOH District Engineer or designee, cleaning, hauling and disposing of existing pavement, tacking of existing surfaces and placing and compacting Asphalt Base II in lifts not exceeding two (2")

REQUEST FOR QUOTATION
Ditch, Pipe, and Asphalt Repair and Maintenance by the Vendor

inches to the level of the existing pavement. Asphalt Base II is to be used for work under this contract, in accordance with Standard Spec 401, or as approved by the WVDOH Engineer. **Asphalt shall be sourced from an MCS&T Approved Asphalt Plant, and stone or crushed aggregate shall be sourced from an MCS&T Approved Material Source.** Tack Coat shall be carried out in accordance with Standard Specs 408 and Pothole Repair on concrete pavement shall be carried out in accordance with Standard Specs 507. Milling for Asphalt Repair Contract Items will be incidental to the work, and not charged for separately.

Any traffic control required shall be charged per Section 3.2.1 of the Contract Specifications. Acceptance Criteria shall be per Section 3.2.6.

Quality control at the plant and in-the-field shall be the responsibility of the Vendor and shall meet the requirements of MP 401.03.50. Compaction quality control shall be in accordance with Section 401 of the Standard Specs. Acceptance testing for compaction shall be the responsibility of the WVDOH. Quality control and Verification testing of the material shall be as set forth in MP 401.02.27 for Marshall Mix designs.

There will be no fuel, binder or other price adjustment to the asphalt used for Asphalt Pavement Repair.

3.2.4.1 Pothole Repair, Contract Items 33 thru 36, shall include all labor, equipment, and materials to complete Pothole Repair, according to EXH 1, Page 6, The Vendor shall bid per the four (4) quantity tiers (0-50, 51-250, 251-500, and 501+) units of square yard, per each mile, as shown on ATT A.

NOTE: To calculate for Asphalt Pothole Repair Pricing, Asphalt repair shall be a depth of two-inch (2") vertical increments. The span by width and length shall be measured by the total number of square yards, per mile. Each two-inch increment would be multiplied by the number of square yards and per mile. Unit quantities would increase for every two-inch (2") increment, and again, per tier.

3.2.4.2 Base Failure Repair, Asphalt, Contract Items 37 thru 40, shall use Asphalt Base II, and shall be bid per the four (4) quantity tiers (0-50, 51-250, 251-500, and 501+) units of square yards, per each mile, as shown on ATT A. Base Failure bids shall include all labor, equipment, and materials to complete Base Failure Repair, according to EXHIBIT 1, Page 7, or as specified by the WVDOH District Engineer or their designee.

REQUEST FOR QUOTATION
Ditch, Pipe, and Asphalt Repair and Maintenance by the Vendor

3.2.4.3 Base Failure Repair, Stone, Contract Items 41 thru 44, shall be bid per the four (4) quantity tier (0-50, 51-250, 251-500, and 501+) units of square yards, per each mile, as shown on ATT A. Base Failure bids shall include all labor, equipment, and materials to complete Base Failure Repair, according to EXHIBIT 1, Page 7, or as specified by the WVDOH District Engineer or their designee.

NOTE: Per EXHIBIT 1, Page 7, “Varies*” shall mean for every 3 inches of asphalt, there shall be 6 inches of stone, unless specified otherwise by the Engineer. When Base Failure Repair significantly exceeds these amounts, additional prorated SY may be paid at the discretion and pre-approval of the Engineer.

3.2.4.4 Edge Failure Repair, Contract Items 45 thru 48, shall include all labor, equipment, and materials to complete Edge Failure Repair according to EXHIBIT 1, Page 8. The Vendor shall bid per the four (4) quantity tier (0-50, 51-250, 251-500, and 501+) units of square yards, per each mile, as shown on ATT A.

3.2.4.5 Haul by Vendor for Asphalt Pavement Repair, Contract Items 49 & 50, will only be requested in combination with other awarded Asphalt Pavement Repair items. The WVDOH Engineer or their designee shall calculate mileage distance utilizing “Google Maps” or a similar source for routing from the Asphalt Plant location to the mid-point of the Agency’s project site. The Agency, at its own discretion, will determine the route to be taken due to bridge and/or road restrictions which shall have acceptable load limits for both roads and bridges.

3.2.4.6 Waste Haul for Asphalt Pavement Repair, Contract Item 51, shall be used for the hauling of/disposal of debris and any material unsuitable for backfill from the project site to a WVDOH approved waste location. This location shall be within proximity to the project site and will be provided on the ADO. The Vendor shall bid an hourly rate per truck/driver.

3.2.4.7 Off-Season Plant Opening, Contract Items 52 & 53: If the Vendor is required to open his plant in the off-season to service the needs of the WVDOH, an additional payment will be made. The Vendor will be paid an additional day charge for each additional consecutive day that the plant is open after the first day to service the needs of the WVDOH. If the plant produces no material for any use on any calendar day, either during the week or on the

REQUEST FOR QUOTATION
Ditch, Pipe, and Asphalt Repair and Maintenance by the Vendor

weekend, the WVDOH will pay the first day rate for off-season plant opening on the next day of the WVDOH usage.

3.2.4.7.1 Payment for this item can only be authorized and made during the winter months, i.e., between December 15th and March 15th, and then only if the plant would not have otherwise been open. These dates may be revised by the WVDOH District Engineer or their designee, if necessary, to meet specific needs in the field. Any such revision of dates will be in writing and shall be attached to the Vendor's invoice at the time payment is requested.

3.2.4.7.2 Payment will always be made at the full contract awarded bid price for the first day of plant opening; however, the amount paid from each additional day of plant opening will be reduced as follows:

- A.** Payment for additional day charge will not be made if the plant has produced over 500 tons on that day. If between 300 and 500 tons have been produced, payment for additional day charge will be made equal to one-half of the contract awarded bid price for the additional day charge. The quantity produced to make this determination shall include all material produced that day, which includes tonnage bought by the WVDOH, other local governments and all private work.
- B.** The WVDOH will only pay its share of the amount determined to be due for additional day charge as described above. For example, if the plant produces 375 tons and the WVDOH takes 150 tons of the total, 40% of the plant's daily production, payment for additional day charge would be calculated as follows: Since the total daily production is between 300 and 500 tons, the Vendor is due 50% of the additional day charge. Because the WVDOH's share of this daily production is 40%, the WVDOH would pay 40% of one-half of the additional day charge, or in this case, 20% of the additional day charges.

3.2.4.7.3 A certified statement shall accompany the invoice stating the total quantity produced on the additional day. If payment does not qualify due to tonnage produced, the

REQUEST FOR QUOTATION
Ditch, Pipe, and Asphalt Repair and Maintenance by the Vendor

next consecutive day of plant operation, if any, will qualify for payment at the additional day rate rather than the first day rate for plant opening.

3.2.5 Mobilization, Contract Items 12-14, 30-32, and 54-56, includes all operations required to move personnel, equipment, supplies and incidentals to a project site. Only one mobilization for category of work (ditching, pipe repair, or asphalt pavement repair) per day of operation will be paid, unless moves of over five (5) miles between individual project locations are required. In cases where a Vendor is required to move from one roadway to the adjacent roadway of a divided highway, additional mobilization for Ditching will only be paid if the nearest interchange or crossing point that will accommodate the Vendor's equipment is over five (5) miles from the project locations.

NOTE: This provision may require roundtrip moves of up to ten (10) miles with no additional mobilization per project payment. An individual project location shall be defined as a project where no skips exceeding 1,000 feet are involved, except between the approach slabs of a bridge or parallel pair of bridges.

3.2.5.1 Daytime Mobilization is a daytime mobilization charge that will be charged per County within a WVDOH District. The Vendor may bid any or all Counties within a WVDOH District. The Vendor shall bid a lump sum cost for mobilization per County.

3.2.5.2 Nighttime Mobilization is a nighttime mobilization charge that will be charged per County within a WVDOH District. The Vendor may bid any or all Counties within a WVDOH District. The Vendor shall bid a lump sum cost for mobilization per County.

3.2.5.3 On-Site Mobilization shall be non-production moves within a project over 1,000 feet, as authorized by the WVDOH District Engineer or their designee. The Vendor shall bid a lump sum.

3.2.5.4 Multiple Mobilizations: If the vendor performs a combination of services under this contract at the same project location, on the same day, they may only charge one mobilization, using the higher mobilization rate bid for either service.

3.2.6 Project Acceptance Criteria: It is the expectation of the WVDOH that the Vendor completes each job in the best possible reasonable timeframe in a professional manner, by competent, trained, experienced, and qualified personnel, while meeting all requirements of the project, prior to the completion date provided by the WVDOH District Engineer or their

REQUEST FOR QUOTATION
Ditch, Pipe, and Asphalt Repair and Maintenance by the Vendor

designee. A daily visual inspection by the WVDOH District Engineer or designee shall be assessed of the project work. The WVDOH reserves the right to dictate the performance of this contract's work and may evaluate materials, methods, and shall have final decision to determine if work is acceptable or complete. Work found not in compliance with the requirements of this contract may be required to be reworked at the Vendor's expense until acceptable by the WVDOH District Engineer or designee. The WVDOH District Engineer or their designee will include a start date and a completion date on the ADO.

Upon completion of the project, the WVDOH District Engineer or designee shall approve the project as acceptable and complete.

- 3.2.7 Emergency Work:** Emergency work as ordered by WVDOH District Engineer, or their designee is work that shall be initiated within forty-eight (48) hours from when the request is received by the vendor. The determination of emergency work will be in accordance with Section 2.6 of this Solicitation and prominently noted on ADO. Designated emergency projects will be paid at 1.50 times the vendors bid price.

4. CONTRACT AWARD:

- 4.1.1 Contract Award:** The contract is intended to provide agencies with a purchase price on all Contract Items. All qualified responsible Vendors shall be awarded a contract for those Contract Items bid which meet all mandatory requirements of this Contract. Vendors do not have to bid all categories of work (Ditching Maintenance & Repair, Pipe Repair & Replacement, or Asphalt Pavement Repair) to be awarded a contract, however they must bid all Traffic Control Contract Items (Part I on ATT A) and all Contract Items within the category of work they are bidding. Vendors may bid any or all categories of work. **Failure to submit bid with Traffic Control and the category of work Contract Items bid in their entirety will result in the disqualification of the bid for the affected category of work.**

- 4.1.2 Determining Low Bid Per Project:** To determine the low bid vendor for individual projects, the WVDOH District Engineer or their designee will calculate the lowest overall total cost of the Contract Items required for individual projects. A written ADO will be issued to the Vendor with the lowest overall total cost.

WVDOH reserves the right to request any one or combination of Contract Items for which bids are awarded at the lowest overall total as set forth in this section.

REQUEST FOR QUOTATION
Ditch, Pipe, and Asphalt Repair and Maintenance by the Vendor

- 4.2 Pricing Pages, Attachment A (“ATT A”):** Vendor shall complete the Pricing Pages by providing a bid price for each Contract Item listed. Vendor shall factor into their bid prices all equipment, materials, delivery, and labor required to provide Contract Items. Vendors may bid on any or all Districts. Vendor shall complete the Pricing Pages for each Contract Item bid in their entirety as failure to do so may result in Vendor’s bids being disqualified. All bids or pricing submitted shall be held and honored by the Vendor for 90 days after the bid opening date.

Vendors may bid projects in any or all Counties. Counties bid with identical pricing can be submitted on one Pricing Page (ATT A) set. If prices vary from county/set of counties, vendor should submit ATT A for each pricing set.

- 4.2.1** The Pricing Pages contain a list of the Contract Items with no guarantee that any Contract Item will be purchased throughout the life of this contract. Estimated quantities are not available.
- 4.2.2** Vendors bidding Ditching Maintenance & Repair must bid Part I - Traffic Control on ATT A as well as all Contract Items listed in Part II - Ditching Maintenance & Repair on ATT A in their entirety.
- 4.2.3** Vendors bidding Pipe Repair & Replacement must bid Part I - Traffic Control on ATT A as well as all Contract Items listed in Part III - Pipe Repair & Replacement on ATT A in their entirety.
- 4.2.4** Vendors bidding Asphalt Pavement Repair must bid Part I - Traffic Control on ATT A as well as all Contract Items listed in Part IV - Asphalt Pavement Repair on ATT A in their entirety.
- 4.2.5** Failure to submit bid with Traffic Control and the category of work (Part II, III, or IV on ATT A) in its entirety will result in the disqualification of the bid, for the category of work bid.
- 4.2.6** Failure to provide Base of Operations information on ATT A will result in the disqualification of the entire bid.
- 4.2.7** Vendor should type or electronically enter the information into the Pricing Pages spreadsheet to prevent errors in the evaluation. In most cases, the Pricing Pages are available in wvOASIS within the solicitation attachments, however, Vendors may request an electronic copy of the Pricing Pages spreadsheet for bid purposes by sending an email request to the following address: DOTProcurement@wv.gov.

REQUEST FOR QUOTATION
Ditch, Pipe, and Asphalt Repair and Maintenance by the Vendor

4.2.8 Changing a column or row description, Contract Item description, or unit of measure on the **Pricing Pages, Attachment A (ATT A)**, shall result in disqualification of the Contract Item bid on the altered line. In circumstances when all Contract Items must be bid for bid evaluation and contract award, the disqualification of any Contract Item will result in the disqualification of the entire bid.

Submitting Pricing Pages other than those provided with this solicitation, as described in Section 4.2 shall result in the disqualification Vendor's bid in its entirety.

Vendor entries of bid prices or other notations made in wvOASIS commodity line descriptions will not be considered for bid evaluation or award.

4.3 Contract Award Transition: Upon award of this contract, the WVDOH Operations Division will announce the effective date of use of this contract to the Districts and the Vendors, whether it is by the effective date, the completed and encumbered date, or an established date by the WVDOH. Upon the announced effective date of use, any order issued prior to the award of the contract shall remain in effect and should not be cancelled until that order is filled; however, after 10 working days of the Districts and Vendors notice, any order that has not been completely filled by the Vendors shall NOT be completed and a cancellation notice will be sent to that Vendor from the issuing District for cancellation of the balance of that order only. No orders from prior contracts should be held open by the Districts or Vendors longer than 10 working days after the effective date of use is announced for the new contract.

5. ORDERING AND PAYMENT:

5.1 Ordering: Vendor shall accept orders through regular mail, facsimile, email, or any other written forms of communication. Vendor shall maintain and keep current its phone numbers, fax number, email address, locations, and ordering/billing/payment addresses with WVDOH and in wvOASIS. Vendor may, but is not required to, accept online orders through a secure internet ordering portal/website. If Vendor can accept online orders, it shall include in its response a brief description of how Agencies may utilize the online ordering system. Vendor shall ensure that its online ordering system is properly secured prior to processing Agency orders online.

5.2 Agency Delivery Order ("ADO"): District personnel must issue an ADO from wvOASIS for specific quantities of materials based on each project's requirements and detailing the need and location information of work to be completed per Contract Items, as well as the start and end dates, which will become the agreed

REQUEST FOR QUOTATION
Ditch, Pipe, and Asphalt Repair and Maintenance by the Vendor

upon official start and end dates. The ADO must be created in wvOASIS and approved to "Final", prior to placing the order with the Vendor. The District is responsible for creating the ADO in OASIS and is required to submit the approved order, in writing, directly to the vendor via mail, email or fax. **Verbal communication with the Vendor is not considered an official order.** In the event the Vendor denies an order or if there are changes to an ADO, the District must process a change order to the approved ADO issued from wvOASIS.

Emergencies shall be prominently noted on the ADO. Once complete, the ADO shall be sent to Vendor via fax, email, or mail.

5.2.1 Lead Time: The WVDOH should plan accordingly to allow the Contractor a minimum of 14 calendar days prior to the date of the agreed upon start date on the ADO to allow Vendor to mobilize and begin work.

5.3 Payment: Upon completion of the work indicated on the ADO, Vendor shall accept payment in accordance with the payment procedures of the State of West Virginia. The State of West Virginia currently utilizes a Purchasing Card program, administered under contract by a banking institution, as well as Electronic Funds Transfer as methods to process payment for goods and services. The Vendor shall accept the State of West Virginia's Purchasing Card and Electronic Funds Transfer for payment of orders under this Contract. Electronic Funds Transfer for payment is available through the WV State Auditor's Office. The Vendor may visit the WV State Auditor's website (wvsao.gov) for all necessary forms and instructions. Payment method may be dictated at WVDOH's discretion.

6. PROJECT ACCEPTANCE, DELIVERY AND RETURN:

6.1 Project Acceptance and Written Verification of Receipt: Upon receipt of a WVDOH ADO, the Vendor shall advise the WVDOH in writing within five (5) calendar days of their acceptance or refusal of the ADO. As verification of receipt, Vendor must provide written acknowledgement of any ADO and any Revisions/Modifications thereto sent by WVDOH. Failure to provide the WVDOH with written acknowledgement of any ADOs/Revisions within five (5) days of the Order being sent shall be considered refusal of the ADO. In the event of refusal, the WVDOH at its own discretion shall cancel the ADO and may seek to obtain the goods or services from the next low bid Vendor or proceed with an emergency purchase from the open market.

6.1.1 Negotiation of Dates: The WVDOH shall have the option to negotiate with the Vendor, the project's tentative start and end dates. **Project work shall be continuous to completion unless otherwise approved in writing by the WVDOH District Engineer or their designee.**

REQUEST FOR QUOTATION
Ditch, Pipe, and Asphalt Repair and Maintenance by the Vendor

- 6.2 Delivery Time:** In accordance with Section 6.1 and the terms of this contract, the work shall be scheduled by the WVDOH. The Vendor shall mobilize, commence, and complete work delivery in accordance with the WVDOH's written ADO, per project. Any changes must be communicated by the Vendor in writing to the WVDOH District Engineer or their designee. The Vendor shall work in an efficient manner in effort to keep traffic delay to a minimum and traffic must be adequately and safely accommodated. Vendor shall ship/provide all orders in accordance with the dates assigned to each project per the ADO and shall not hold orders until a minimum delivery quantity is met. **No Vendor is authorized to ship project related goods or begin work/services, nor is the WVDOH authorized to receive materials, prior to the issuance of an ADO.**
- 6.3 Adverse Weather Conditions:** Unsuitable/adverse/inclement weather conditions may dictate the work schedule. It is preferred that operations be suspended immediately when an inclement weather event begins or if the WVDOH District Engineer or their designee determines that an inclement weather event is imminent. If working conditions are dangerous or unsuitable for the WVDOH, Vendor, or general public, work shall be suspended by the WVDOH Engineer/designee. If needed, revision to the project's start and end date may be negotiated by the Vendor and the WVDOH Engineer/designee. After a weather-related suspension of work, the WVDOH District Engineer or their designee shall determine and convey in writing, such ADO changes and when work shall commence/resume, followed by the Vendor's written acknowledgement, per Section 6.4 of this Contract Solicitation.
- 6.4 Late Delivery:** The Agency placing the order under this Contract must be notified in writing if orders will be delayed for any reason. Any delay in delivery that could cause harm to an Agency will be grounds for cancellation of the delayed order, and/or obtaining the items ordered from another awarded vendor or proceed with an Emergency Purchase from the open market.

The Agency placing the ADO under this Contract must be notified **in writing by the Vendor no later than five (5) business days prior to the scheduled start date noted on the Agency's order.** Any failure to notify, acknowledge receipt of WVDOH's written ADOs/ Revisions resulting in delivery delay, or failure to start or complete the project per the WVDOH scheduled due dates may be determined by the WVDOH at its sole discretion as harmful to the Agency and as such, shall result in WVDOH's cancellation of the ADO and application of Liquidated Damages.

Any Agency seeking to obtain items from the open market under this provision must first obtain approval of the WVDOH Budget & Procurement Division.

6.4.1 Liquidated Damages: If the Vendor's work completion or corrections of

REQUEST FOR QUOTATION
Ditch, Pipe, and Asphalt Repair and Maintenance by the Vendor

deficient work exceeds the ADO completion due date or timeframe, the Vendor shall agree that no extension of contract time will be granted unless Liquidated Damages are applied by the WVDOH in the form of an off-set reduction to the total amount of the Vendor's final invoice. The WVDOH shall calculate Liquidated Damages per project beginning on day one (1) after the WVDOH's specified ADO due date and in accordance with this Section, the Contract's Terms and Conditions, Standard Specs Section 108.7, and the following Standard Specs Section Table 108.7.1 - Schedule of Liquidated Damages, as amended:

**Table 108.7.1
 Schedule of Liquidated Damages**

Original Contract Amount		Daily Charges Per Calendar Day
For More Than	To and Including	
\$0	\$500,000	\$350
\$500,000	\$2,000,000	\$650
\$2,000,000	\$10,000,000	\$1,600
\$10,000,000	\$25,000,000	\$3,100
\$25,000,000		\$4,200

6.4.2 Force Majeure: It shall be further noted that the Vendor is not responsible for and shall not be penalized for delays in its delivery of goods and/or services when caused by factors or events outside Vendor's control, including but not limited to acts or omissions of the Agency or third parties, acts of civil or military authority, civil disturbance, war, terrorism, pandemics, explosions, fire, floods, tornadoes, or other natural disasters or acts of God.

6.5 Delivery Payment/Risk of Loss: Standard order delivery shall be F.O.B. destination to the Agency's location. Vendor shall include the cost/discount of standard order delivery charges in its bid pricing and is not permitted to charge the Agency separately for such delivery. The Agency will pay delivery charges on all emergency orders provided that Vendor invoices those delivery costs as a separate charge with the original freight bill attached to the invoice.

Deliveries made by the vendor shall be comprised only of Contract Items intended for delivery at that location and specified in the pricing pages, contract specifications or ADO. At no time shall property belonging to the West Virginia Department of Transportation be utilized as a lay-down or storage facility by the vendor, or items left with the intention of being distributed to an alternate location.

6.6 Project Acceptance Criteria: The WVDOH District Engineer or their designee shall have final acceptance of the work done by the Vendor, per project. Any work found by the WVDOH District Engineer or their designee not performed in

REQUEST FOR QUOTATION
Ditch, Pipe, and Asphalt Repair and Maintenance by the Vendor

accordance with these contract specifications or the Standard Specs, as amended, and/or found deficient and unacceptable by visual inspection will be rejected and, at the Vendor's/Contractor's expense, will be removed and replaced by the Vendor with work being continual until the Vendor's deficient work corrections are completed and deemed acceptable and approved by the WVDOH District Engineer or their designee. Under no circumstance shall the Vendor's deficiency corrections exceed twenty (20) calendar days unless otherwise declared in writing by the WVDOH District Engineer or their designee and may be subject to Liquidated Damages as per Section 6.5.1 of these Contract Specifications.

- 6.7 Return of Unacceptable Items:** The decision of the WVDOH District Engineer or their designee regarding materials, workmanship, quality etc., shall be final per the Standard Specs Section 105.1, as amended. If the Agency deems the Contract Items to be unacceptable, the Contract Items shall be returned to Vendor at Vendor's expense and with no restocking charge. Vendor shall either arrange for the return within five (5) days of being notified that items are unacceptable or permit the Agency to arrange for the return and reimburse Agency for delivery expenses. If the original packaging cannot be utilized for the return, Vendor will supply the Agency with appropriate return packaging upon request. All returns of unacceptable items shall be F.O.B. the Agency's location. The returned product shall either be replaced, or the Agency shall receive a full credit or refund for the purchase price, at the Agency's discretion.
- 6.8 Return Due to Agency Error:** Items ordered in error by the Agency will be returned for credit within 30 days of receipt, F.O.B. Vendor's location. Vendor shall not charge a restocking fee if returned products are in a resalable condition. Items shall be deemed to be in a resalable condition if they are unused and in the original packaging. Any restocking fee for items not in a resalable condition shall be the lower of the Vendor's customary restocking fee or 5% of the total invoiced value of the returned items.

7. VENDOR DEFAULT:

- 7.1** The following shall be considered a vendor default under this Contract.
- 7.1.1** Failure to provide Contract Items in accordance with the requirements contained herein.
- 7.1.2** Failure to comply with other specifications and requirements contained herein.

REQUEST FOR QUOTATION
Ditch, Pipe, and Asphalt Repair and Maintenance by the Vendor

- 7.1.3 Failure to comply with any laws, rules, and ordinances applicable to the Contract Services provided under this Contract.
- 7.1.4 Failure to remedy deficient performance upon request.
- 7.2 The following remedies shall be available to Agency upon default.
 - 7.2.1 Immediate cancellation of the Contract.
 - 7.2.2 Immediate cancellation of one or more release orders issued under this Contract.
 - 7.2.3 Any other remedies available in law or equity.

8. MISCELLANEOUS:

- 8.1 **No Substitutions:** Vendor shall supply only Contract Items submitted in response to the Solicitation unless a contract modification is approved in accordance with the provisions contained in this Contract.
- 8.2 **Vendor Supply:** Vendor must carry sufficient inventory of the Contract Items being offered to fulfill its obligations under this Contract. By signing its bid, Vendor certifies that it can supply the Contract Items contained in its bid response.
- 8.3 **Reports:** Vendor shall provide the Agency with quarterly reports, annual summaries, and/or monthly reports as requested by the Agency and/or the West Virginia Purchasing Division showing quantities, total dollar value of the Contract Items purchased, ordered, shipped & invoiced with dates in spreadsheet format as defined by the Agency. Failure to supply such reports may be grounds for cancellation of this Contract.
- 8.4 **Contract Manager:** During its performance of this Contract, Vendor must designate and maintain a primary contract manager responsible for overseeing Vendor's responsibilities under this Contract. The Contract Manager must be available during normal business hours to address any customer service or other issues related to this Contract. Vendor should list its Contract Manager and his or her contact information below.

Contract Manager: David Lash
Telephone Number: 740-296-8009
Fax Number: 724-745-7778
Email Address: dlash@castandbaker.com

REQUEST FOR QUOTATION
Ditch, Pipe, and Asphalt Repair and Maintenance by the Vendor

Vendor shall inform the Agency in writing of any changes to the information provided above within 10 calendar days of such changes. Failure to comply may be grounds for cancellation of this contract.

ADDENDUM ACKNOWLEDGEMENT FORM
SOLICITATION NO.: ARFQ DOT2500000026

Instructions: Please acknowledge receipt of all addenda issued with this solicitation by completing this addendum acknowledgment form. Check the box next to each addendum received and sign below. Failure to acknowledge addenda may result in bid disqualification.

Acknowledgment: I hereby acknowledge receipt of the following addenda and have made the necessary revisions to my proposal, plans and/or specification, etc.

Addendum Numbers Received:
(Check the box next to each addendum received)

- | | |
|--|--|
| <input checked="" type="checkbox"/> Addendum No. 1 | <input type="checkbox"/> Addendum No. 6 |
| <input type="checkbox"/> Addendum No. 2 | <input type="checkbox"/> Addendum No. 7 |
| <input type="checkbox"/> Addendum No. 3 | <input type="checkbox"/> Addendum No. 8 |
| <input type="checkbox"/> Addendum No. 4 | <input type="checkbox"/> Addendum No. 9 |
| <input type="checkbox"/> Addendum No. 5 | <input type="checkbox"/> Addendum No. 10 |

I understand that failure to confirm the receipt of addenda may be cause for rejection of this bid. I further understand that any verbal representation made or assumed to be made during any oral discussion held between Vendor's representatives and any state personnel is not binding. Only the information issued in writing and added to the specifications by an official addendum is binding.

Cast & Baker Corporation

Company

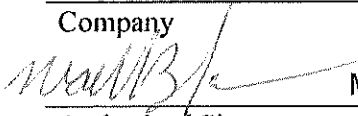

Michael J. Baker

Authorized Signature

1/20/25

Date

NOTE: This addendum acknowledgement should be submitted with the bid to expedite document processing.

REQUEST FOR QUOTATION
Ditch, Pipe, and Asphalt Repair and Maintenance by the Vendor

SPECIFICATIONS

1. **PURPOSE AND SCOPE:** The West Virginia Division of Highways is soliciting bids to establish an open-end contract for roadway maintenance and repair projects at various project sites throughout the State of West Virginia, to include all materials, equipment, and labor by the Vendor to perform ditch maintenance and repair, pipe repair and replacement, and asphalt pavement patching and repair. This contract is intended to supplement the WVDOH work force for such maintenance work.

2. **DEFINITIONS:** The terms listed below shall have the following meanings assigned to them throughout and for the purpose of this Solicitation. Additional definitions can be found in Section 2 of the General Terms and Conditions.
 - 2.1 **“AASHTO”** - The American Association of State Highway and Transportation Officials is a standard setting body which publishes specifications, test protocols, and guidelines that are used in highway design and construction throughout the United States. Reference: www.transportation.org.
 - 2.2 **“ADO” and “Agency Delivery Order”** - A written order entered by WVDOH personnel in the wvOASIS financial system against a master agreement, authorizing quantities of commodities and/or services to be delivered in accordance with all terms, conditions, and prices stipulated in the original contract.
 - 2.3 **“Approved Source,” “Approved Plant,” “Approved Product,” or “Approved Vendor”** - terms referring to the Approved Product Lists (APL) of certified manufacturers and/or products that meet acceptable levels of quality as determined by WVDOH Materials Control, Soils and Testing Division (MCS&T). These lists are updated periodically, and it is the Vendors responsibility to refer to the MCS&T website to ensure compliance. Reference: https://transportation.wv.gov/highways/mcst/Pages/APL_By_Number.aspx.
 - 2.4 **“Asphalt,” “Hot Mix Asphalt” and “HMA”** - Terms used interchangeably for asphalt.
 - 2.5 **“Contract Item”** - The list of items available for Vendor to provide pricing as identified in Section 3.2 of this Solicitation and referenced throughout.
 - 2.6 **“Emergency Work”** – Work or orders required to be done without delay owing to circumstances for which the WVDOH could not have reasonably expected and has been designated as such by a representative of the WVDOH.

REQUEST FOR QUOTATION
Ditch, Pipe, and Asphalt Repair and Maintenance by the Vendor

- 2.7 **“EPA”** - Environmental Protection Agency and the WV Department of Environmental Protection and references the Federal, State, and Local levels of government. www.epa.gov and www.dep.wv.gov.
- 2.8 **“Exhibit 1” and “EXH 1”** – Standard Details relevant to work under this contract. Details are excerpts of the West Virginia Division of Highways Engineering Division Typical Sections and Related Details, 2019 edition.
- 2.9 **“FOB” or “Free on Board”** - Indicates that the price for goods includes delivery at the Vendor’s expense to a specified point, and that the Vendor retains liability for loss or damage until the goods are delivered.
- 2.10 **“Liquidated Damages”** - Monetary compensation due from the Vendor in the event the Vendor’s performance falls short of contractual stipulation or breaches the contract. Delays in the delivery of goods and/or services or quality failures or corrections by the Vendor may result in the Agency assessing charges for such deficiencies per these contract Specifications, the Standard Specs Section 108.7, as amended, and calculated from the table posted in Section 6.4.1 of these Specifications.
- 2.11 **“MCS&T”** - The WVDOH Materials Control, Soil and Testing Division, who perform all procedures necessary with sampling, testing, reporting and inspection of products and materials to maintain a reliable quality assurance system. Reference: <http://www.transportation.wv.gov/highways/mcst/Pages/default.aspx>.
- 2.12 **“MP”** - Material Procedures, as amended, issued by the WVDOH Materials Control, Soils and Testing Division. The MP numbers referenced throughout these Contract Specifications are available by MP number at: <https://transportation.wv.gov/highways/mcst/Pages/WVDOH-Materials-Procedures.aspx>
- 2.13 **“Pricing Pages,” “Attachment A,” and “ATT A”** - The schedule of prices attached hereto as Attachment A (ATT A) and used to evaluate Solicitation responses.
- 2.14 **“Solicitation”** - The official notice of an opportunity to supply the State with goods or services.
- 2.15 **“Standard Specs”** - Used throughout this solicitation means the West Virginia Department of Transportation, Division of Highways Standard Specifications, Roads and Bridges, most recent edition, as modified or amended by all subsequent Supplemental Specifications.

REQUEST FOR QUOTATION
Ditch, Pipe, and Asphalt Repair and Maintenance by the Vendor

- 2.16 “Vendor” or “Contractor”**- Interchangeably used throughout this Solicitation and in any cited Sections of the West Virginia Department of Transportation, Division of Highways Standard Specifications, Roads and Bridges, adopted latest Standard Specs edition, as amended, including any Supplementals and refers to any entity submitting a bid in response to the Solicitation, the entity that has been selected as the lowest responsible bidder, or the entity that has been awarded the Contract, as context requires.
- 2.17 “WVDOH” or “Agency”** - Interchangeable terms for the West Virginia Division of Highways.

3. GENERAL REQUIREMENTS:

- 3.1 Standard Specifications Roads and Bridges:** The following Standard Specs Sections shall apply, as applicable, to the administration of this contract: 101, 102, 103, 104, 105, 106, 107, 108, 109, and 110, as amended.

Materials, equipment, and performance of this contract shall conform to, but are not limited to, the requirements of Sections 207, 211, 219, 229, 240, 307, 401, 408, 507, 604 and 636, as amended.

Free electronic copies of the Standard Specs and Supplementals are available at: <https://transportation.wv.gov/highways/TechnicalSupport/specifications/Pages/default.aspx>. Hard copies of these publications may be purchased from the Technical Support Division by completing the Specification Order Form provided within the website.

- 3.2 Contract Items and Mandatory Requirements:** Vendor shall provide Agency with the Contract Items listed below on an open-end and continuing basis. Contract Items are listed on the Pricing Pages which hereafter shall be referred to as “ATT A.” Contract Items must meet or exceed the mandatory requirements as shown below.

The project start date and completion date should be noted on the ADO. Prior to the beginning of any work, the Vendor shall contact Miss Utility of WV via the WV811 app or by dialing 811 at least two business days prior to the ADO’s project start date to allow the utility to identify and mark their facilities. A reference number will be provided to the Vendor to serve as proof of the contact. The Vendor shall retain this reference number with the ADO for possible future need or justification.

Guardrails are the responsibility of WVDOH. WVDOH forces shall perform any guardrail removal, repair, or replacement work needed at project sites. Erosion Control will be the responsibility of WVDOH.

REQUEST FOR QUOTATION
Ditch, Pipe, and Asphalt Repair and Maintenance by the Vendor

3.2.1 Traffic Control, Contract Items 1 thru 4. While undergoing improvement, the project site shall be kept open to traffic in such condition that both local and through traffic will be adequately and safely accommodated. All improvement operations shall be scheduled by the Vendor to keep traffic delay to a minimum.

3.2.1.1 Vendor shall provide traffic control for all projects covered by this contract, unless otherwise instructed by the WVDOH Engineer. Traffic shall be maintained by the Vendor in accordance with Standard Specs Section 636. All traffic control devices shall be fabricated and installed according to the “Manual on Temporary Traffic Control for Streets and Highways”, latest version, published by the Agency at <https://transportation.wv.gov/highways/traffic/Documents/TemporaryTrafficControlManual2006.pdf>. The type of construction operation being performed will dictate the traffic control case (scheme) to be used as outlined in this manual and as called for on the Plans. The Vendor shall submit their Traffic Control Plans to the WVDOH Engineer or their designee with their written Project Acceptance/ ADO Acknowledgement, as required in section 6.1 of these Contract Specifications. Vendors Traffic Control Plans are subject to WVDOH approval.

3.2.1.2 The cost for Bridging/Plating material used to maintain traffic at the end of a work shift shall be incidental to the project and shall be at no additional cost to the WVDOH.

3.2.1.3 The roadway shall be free of dirt, debris, and excessive dust and opened to the traveling public at the end of each shift with no additional cost to the WVDOH.

3.2.1.4 If the vendor performs a combination of services under this contract at the same project location, on the same day, they may only charge for traffic control services once.

3.2.2 Ditching Maintenance & Repair, Contract Items 5 thru 14, shall be used for trimming, sloping and cleaning to open all inlets and outlets identified on an ADO. Work shall be carried out in accordance with Standard Specs 207, 211, and 229.

Ditches shall be inspected for damage prior to the start of work. If damage is discovered, this shall be reported to the WVDOH District Engineer or designee for further instructions. Ditches shall be cleared of

REQUEST FOR QUOTATION
Ditch, Pipe, and Asphalt Repair and Maintenance by the Vendor

all obstructions, such as, but not limited to, trees, branches, and boulders, to allow the ditch flowline of water to be led to a suitable place of discharge.

All debris/obstacles removed from a ditch shall be disposed of by the Vendor in accordance with EPA waste disposal laws and regulations. Debris/obstacles that can be recycled/mulched/crushed may only be used to complete the project with the prior approval by the WVDOH District Engineer or designee.

All labor, equipment and material to complete ditching work shall be included in the unit bid prices. Any traffic control required shall be charged per Section 3.2.1 of these Contract Specifications. Acceptance Criteria shall be per Section 3.2.6.

3.2.2.1 Ditching, Contract Item 5, shall meet the depth and width requirements of the Standard Detail for Shoulder and Ditches, EXH 1, Page 1, as directed by the Delivery Order and the WVDOH District Engineer or designee and shall be bid per shoulder mile.

3.2.2.2 Correcting Deep Ditches, Contract Item 6, shall meet the Rock Borrow Excavation requirements of the Standard Detail for Correcting Deep Ditches, EXH 1, Page 2, or as directed by the Delivery Order and the WVDOH District Engineer or designee and shall be bid per ton.

3.2.2.3 Restoring Shoulders, Contract Item 7, shall meet the requirements of the Standard Detail for Restoring Shoulders for Guardrail & Sliver Fills, EXH 1, Page 3, or as directed by the Delivery Order and the WVDOH District Engineer or designee and shall be bid per ton.

3.2.2.4 Shoulder Stone Placement, Contract Item 8, shall meet the requirements of the Standard Detail for Shoulder Reconstruction, EXH 1, Page 4, or as directed by the Delivery Order and the WVDOH District Engineer or designee and shall be bid per ton.

3.2.2.5 Ditching Haul of Materials by Vendor, Contract Items 9 & 10, will only be requested in combination with other awarded ditching items. The WVDOH Engineer or their designee shall calculate mileage distance utilizing "Google Maps" or a similar source for routing from the Vendor's nearest Base of Operations location, as identified on ATT A, to the mid-point of the Agency's project site.

REQUEST FOR QUOTATION
Ditch, Pipe, and Asphalt Repair and Maintenance by the Vendor

The Agency, at its own discretion, will determine the route to be taken due to bridge and/or road restrictions which shall have acceptable load limits for both roads and bridges.

3.2.2.6 Waste Haul for Ditching, Contract Item 11, shall be used for the hauling of/disposal of debris and any material unsuitable for backfill from the project site to a WVDOH approved waste location. This location shall be within proximity to the project site and will be provided on the ADO. The Vendor shall bid an hourly rate per truck/driver.

3.2.3 Pipe Repair & Replacement, Contract Items 15 thru 32. Repair & replacement pipe shall be installed to match the existing inlet and outlet invert elevations unless otherwise directed by the WVDOH District Engineer or designee. The minimum and maximum depth of cover shall be as per the manufacturer's recommendation and shall be no less than 12 inches, unless specified otherwise by the WVDOH Engineer or their designee on the ADO. Work shall be carried out in accordance with Standard Specs 207, and 604. The vendor shall be responsible for the removal and proper disposal of old pipe at no additional charge.

Prior to the issuance of a Delivery Order for Pipe Repair/Replacement, the WVDOH District Engineer or designee shall have all required Environmental Permits in place. The WVDOH shall provide the pipe and pipe hardware required for project. The ADO will indicate whether the Vendor or the WVDOH is responsible for picking up pipe materials and transporting them to the project site. Pick Up of project materials from WVDOH shall be incidental to mobilization. Erosion Control will be the responsibility of the WVDOH. Any traffic control required shall be charged per Section 3.2.1 of these Contract Specifications. Acceptance Criteria shall be per Section 3.2.6.

3.2.3.1 Pipe Repair and Replacement, Contract Items 15 thru 23, shall include all labor, equipment, and materials, excluding pipe and pipe hardware and backfill material, excluding CLSM for F Trenches, in the unit bid price. Bid price shall be per linear foot.

Pipe Repair & Replacement shall meet the requirements of the Standard Detail for Repaving Pipe Trenches F, EXH 1, Page 5, or as identified by the Delivery Order or the WVDOH District Engineer or designee and shall be bid per linear foot.

3.2.3.2 Pipe Repair/Replacement Backfill for F Trench, Contract Item 24, for shall bid CLSM backfill by the cubic yard. The cost of

REQUEST FOR QUOTATION
Ditch, Pipe, and Asphalt Repair and Maintenance by the Vendor

materials per cubic yard shall include haul up to five (5) miles within the bid price.

When replacing gravel surfaces, Type F Trench backfill shall be no less than 12 inches below the surface.

3.2.3.3 Additional Haul of Backfill for F Trench, Contract Item 25:

Additional Haul is to be charged for distances exceeding five (5) miles and is to only be used with Contract Item 24. Haul shall be one way and measured per loaded mile from Vendor's source plant to the WVDOH project site, for the portion of the haul which exceeds five (5) miles. Vendor shall use suitable routes selected by the Agency District Engineer. All such chosen routes shall have acceptable load limits for both roads and bridges.

3.2.3.4 Safe Access and Egress Surcharge, Contract Items 26-28.

To meet OSHA standards required for trenching, sloping, shoring, use of shielding protections or other types of supports to prevent soil cave-ins, after a depth of 4-foot, the Vendor may add a surcharge to the project. If the WVDOH District Engineer or designee did not include this surcharge in their initial estimated cost for the project, the Vendor shall advise the WVDOH District Engineer or designee as soon as possible. The WVDOH District Engineer or designee may agree or disagree with the Vendor's request; the decision of the District Engineer shall be final.

3.2.3.5 Waste Haul for Pipe Repair/Replacement, Contract Item 29,

shall be used for the hauling of/disposal of debris and any material unsuitable for backfill from the project site to a WVDOH approved waste location. This location shall be within proximity to the project site and will be provided on the Delivery Order. The Vendor shall bid an hourly rate per truck/driver.

3.2.4 Asphalt Pavement Repair, Contract Items 33 thru 56: Pothole Repair, Base Failure Repair, or Edge Failure Repair shall be requested to correct potholes, edge failures, upheavals, settlements, cracking, raveling and base failures to prevent further deterioration, eliminate safety hazards, improve riding quality and restore proper drainage as identified on an ADO.

Repairing an existing pavement shall consist of squaring up the repair area, removing damaged material to a depth, per the Standard Detail, directed by the WVDOH District Engineer or designee, cleaning, hauling and disposing of existing pavement, tacking of existing surfaces and placing and compacting Asphalt Base II in lifts not exceeding two (2")

REQUEST FOR QUOTATION
Ditch, Pipe, and Asphalt Repair and Maintenance by the Vendor

inches to the level of the existing pavement. Asphalt Base II is to be used for work under this contract, in accordance with Standard Spec 401, or as approved by the WVDOH Engineer. **Asphalt shall be sourced from an MCS&T Approved Asphalt Plant, and stone or crushed aggregate shall be sourced from an MCS&T Approved Material Source.** Tack Coat shall be carried out in accordance with Standard Specs 408 and Pothole Repair on concrete pavement shall be carried out in accordance with Standard Specs 507. Milling for Asphalt Repair Contract Items will be incidental to the work, and not charged for separately.

Any traffic control required shall be charged per Section 3.2.1 of the Contract Specifications. Acceptance Criteria shall be per Section 3.2.6.

Quality control at the plant and in-the-field shall be the responsibility of the Vendor and shall meet the requirements of MP 401.03.50. Compaction quality control shall be in accordance with Section 401 of the Standard Specs. Acceptance testing for compaction shall be the responsibility of the WVDOH. Quality control and Verification testing of the material shall be as set forth in MP 401.02.27 for Marshall Mix designs.

There will be no fuel, binder or other price adjustment to the asphalt used for Asphalt Pavement Repair.

3.2.4.1 Pothole Repair, Contract Items 33 thru 36, shall include all labor, equipment, and materials to complete Pothole Repair, according to EXH 1, Page 6, The Vendor shall bid per the four (4) quantity tiers (0-50, 51-250, 251-500, and 501+) units of square yard, per each mile, as shown on ATT A.

NOTE: To calculate for Asphalt Pothole Repair Pricing, Asphalt repair shall be a depth of two-inch (2”) vertical increments. The span by width and length shall be measured by the total number of square yards, per mile. Each two-inch increment would be multiplied by the number of square yards and per mile. Unit quantities would increase for every two-inch (2”) increment, and again, per tier.

3.2.4.2 Base Failure Repair, Asphalt, Contract Items 37 thru 40, shall use Asphalt Base II, and shall be bid per the four (4) quantity tiers (0-50, 51-250, 251-500, and 501+) units of square yards, per each mile, as shown on ATT A. Base Failure bids shall include all labor, equipment, and materials to complete Base Failure Repair, according to EXHIBIT 1, Page 7, or as specified by the WVDOH District Engineer or their designee.

REQUEST FOR QUOTATION
Ditch, Pipe, and Asphalt Repair and Maintenance by the Vendor

3.2.4.3 Base Failure Repair, Stone, Contract Items 41 thru 44, shall be bid per the four (4) quantity tier (0-50, 51-250, 251-500, and 501+) units of square yards, per each mile, as shown on ATT A. Base Failure bids shall include all labor, equipment, and materials to complete Base Failure Repair, according to EXHIBIT 1, Page 7, or as specified by the WVDOH District Engineer or their designee.

NOTE: Per EXHIBIT 1, Page 7, “Varies*” shall mean for every 3 inches of asphalt, there shall be 6 inches of stone, unless specified otherwise by the Engineer. When Base Failure Repair significantly exceeds these amounts, additional prorated SY may be paid at the discretion and pre-approval of the Engineer.

3.2.4.4 Edge Failure Repair, Contract Items 45 thru 48, shall include all labor, equipment, and materials to complete Edge Failure Repair according to EXHIBIT 1, Page 8. The Vendor shall bid per the four (4) quantity tier (0-50, 51-250, 251-500, and 501+) units of square yards, per each mile, as shown on ATT A.

3.2.4.5 Haul by Vendor for Asphalt Pavement Repair, Contract Items 49 & 50, will only be requested in combination with other awarded Asphalt Pavement Repair items. The WVDOH Engineer or their designee shall calculate mileage distance utilizing “Google Maps” or a similar source for routing from the Asphalt Plant location to the mid-point of the Agency’s project site. The Agency, at its own discretion, will determine the route to be taken due to bridge and/or road restrictions which shall have acceptable load limits for both roads and bridges.

3.2.4.6 Waste Haul for Asphalt Pavement Repair, Contract Item 51, shall be used for the hauling of/disposal of debris and any material unsuitable for backfill from the project site to a WVDOH approved waste location. This location shall be within proximity to the project site and will be provided on the ADO. The Vendor shall bid an hourly rate per truck/driver.

3.2.4.7 Off-Season Plant Opening, Contract Items 52 & 53: If the Vendor is required to open his plant in the off-season to service the needs of the WVDOH, an additional payment will be made. The Vendor will be paid an additional day charge for each additional consecutive day that the plant is open after the first day to service the needs of the WVDOH. If the plant produces no material for any use on any calendar day, either during the week or on the

REQUEST FOR QUOTATION
Ditch, Pipe, and Asphalt Repair and Maintenance by the Vendor

weekend, the WVDOH will pay the first day rate for off-season plant opening on the next day of the WVDOH usage.

3.2.4.7.1 Payment for this item can only be authorized and made during the winter months, i.e., between December 15th and March 15th, and then only if the plant would not have otherwise been open. These dates may be revised by the WVDOH District Engineer or their designee, if necessary, to meet specific needs in the field. Any such revision of dates will be in writing and shall be attached to the Vendor's invoice at the time payment is requested.

3.2.4.7.2 Payment will always be made at the full contract awarded bid price for the first day of plant opening; however, the amount paid from each additional day of plant opening will be reduced as follows:

- A.** Payment for additional day charge will not be made if the plant has produced over 500 tons on that day. If between 300 and 500 tons have been produced, payment for additional day charge will be made equal to one-half of the contract awarded bid price for the additional day charge. The quantity produced to make this determination shall include all material produced that day, which includes tonnage bought by the WVDOH, other local governments and all private work.
- B.** The WVDOH will only pay its share of the amount determined to be due for additional day charge as described above. For example, if the plant produces 375 tons and the WVDOH takes 150 tons of the total, 40% of the plant's daily production, payment for additional day charge would be calculated as follows: Since the total daily production is between 300 and 500 tons, the Vendor is due 50% of the additional day charge. Because the WVDOH's share of this daily production is 40%, the WVDOH would pay 40% of one-half of the additional day charge, or in this case, 20% of the additional day charges.

3.2.4.7.3 A certified statement shall accompany the invoice stating the total quantity produced on the additional day. If payment does not qualify due to tonnage produced, the

REQUEST FOR QUOTATION
Ditch, Pipe, and Asphalt Repair and Maintenance by the Vendor

next consecutive day of plant operation, if any, will qualify for payment at the additional day rate rather than the first day rate for plant opening.

3.2.5 Mobilization, Contract Items 12-14, 30-32, and 54-56, includes all operations required to move personnel, equipment, supplies and incidentals to a project site. Only one mobilization for category of work (ditching, pipe repair, or asphalt pavement repair) per day of operation will be paid, unless moves of over five (5) miles between individual project locations are required. In cases where a Vendor is required to move from one roadway to the adjacent roadway of a divided highway, additional mobilization for Ditching will only be paid if the nearest interchange or crossing point that will accommodate the Vendor's equipment is over five (5) miles from the project locations.

NOTE: This provision may require roundtrip moves of up to ten (10) miles with no additional mobilization per project payment. An individual project location shall be defined as a project where no skips exceeding 1,000 feet are involved, except between the approach slabs of a bridge or parallel pair of bridges.

3.2.5.1 Daytime Mobilization is a daytime mobilization charge that will be charged per County within a WVDOH District. The Vendor may bid any or all Counties within a WVDOH District. The Vendor shall bid a lump sum cost for mobilization per County.

3.2.5.2 Nighttime Mobilization is a nighttime mobilization charge that will be charged per County within a WVDOH District. The Vendor may bid any or all Counties within a WVDOH District. The Vendor shall bid a lump sum cost for mobilization per County.

3.2.5.3 On-Site Mobilization shall be non-production moves within a project over 1,000 feet, as authorized by the WVDOH District Engineer or their designee. The Vendor shall bid a lump sum.

3.2.5.4 Multiple Mobilizations: If the vendor performs a combination of services under this contract at the same project location, on the same day, they may only charge one mobilization, using the higher mobilization rate bid for either service.

3.2.6 Project Acceptance Criteria: It is the expectation of the WVDOH that the Vendor completes each job in the best possible reasonable timeframe in a professional manner, by competent, trained, experienced, and qualified personnel, while meeting all requirements of the project, prior to the completion date provided by the WVDOH District Engineer or their

REQUEST FOR QUOTATION
Ditch, Pipe, and Asphalt Repair and Maintenance by the Vendor

designee. A daily visual inspection by the WVDOH District Engineer or designee shall be assessed of the project work. The WVDOH reserves the right to dictate the performance of this contract's work and may evaluate materials, methods, and shall have final decision to determine if work is acceptable or complete. Work found not in compliance with the requirements of this contract may be required to be reworked at the Vendor's expense until acceptable by the WVDOH District Engineer or designee. The WVDOH District Engineer or their designee will include a start date and a completion date on the ADO.

Upon completion of the project, the WVDOH District Engineer or designee shall approve the project as acceptable and complete.

- 3.2.7 Emergency Work:** Emergency work as ordered by WVDOH District Engineer, or their designee is work that shall be initiated within forty-eight (48) hours from when the request is received by the vendor. The determination of emergency work will be in accordance with Section 2.6 of this Solicitation and prominently noted on ADO. Designated emergency projects will be paid at 1.50 times the vendors bid price.

4. CONTRACT AWARD:

- 4.1.1 Contract Award:** The contract is intended to provide agencies with a purchase price on all Contract Items. All qualified responsible Vendors shall be awarded a contract for those Contract Items bid which meet all mandatory requirements of this Contract. Vendors do not have to bid all categories of work (Ditching Maintenance & Repair, Pipe Repair & Replacement, or Asphalt Pavement Repair) to be awarded a contract, however they must bid all Traffic Control Contract Items (Part I on ATT A) and all Contract Items within the category of work they are bidding. Vendors may bid any or all categories of work. **Failure to submit bid with Traffic Control and the category of work Contract Items bid in their entirety will result in the disqualification of the bid for the affected category of work.**
- 4.1.2 Determining Low Bid Per Project:** To determine the low bid vendor for individual projects, the WVDOH District Engineer or their designee will calculate the lowest overall total cost of the Contract Items required for individual projects. A written ADO will be issued to the Vendor with the lowest overall total cost.

WVDOH reserves the right to request any one or combination of Contract Items for which bids are awarded at the lowest overall total as set forth in this section.

REQUEST FOR QUOTATION
Ditch, Pipe, and Asphalt Repair and Maintenance by the Vendor

- 4.2 Pricing Pages, Attachment A (“ATT A”):** Vendor shall complete the Pricing Pages by providing a bid price for each Contract Item listed. Vendor shall factor into their bid prices all equipment, materials, delivery, and labor required to provide Contract Items. Vendors may bid on any or all Districts. Vendor shall complete the Pricing Pages for each Contract Item bid in their entirety as failure to do so may result in Vendor’s bids being disqualified. All bids or pricing submitted shall be held and honored by the Vendor for 90 days after the bid opening date.

Vendors may bid projects in any or all Counties. Counties bid with identical pricing can be submitted on one Pricing Page (ATT A) set. If prices vary from county/set of counties, vendor should submit ATT A for each pricing set.

- 4.2.1** The Pricing Pages contain a list of the Contract Items with no guarantee that any Contract Item will be purchased throughout the life of this contract. Estimated quantities are not available.
- 4.2.2** Vendors bidding Ditching Maintenance & Repair must bid Part I - Traffic Control on ATT A as well as all Contract Items listed in Part II - Ditching Maintenance & Repair on ATT A in their entirety.
- 4.2.3** Vendors bidding Pipe Repair & Replacement must bid Part I - Traffic Control on ATT A as well as all Contract Items listed in Part III - Pipe Repair & Replacement on ATT A in their entirety.
- 4.2.4** Vendors bidding Asphalt Pavement Repair must bid Part I - Traffic Control on ATT A as well as all Contract Items listed in Part IV - Asphalt Pavement Repair on ATT A in their entirety.
- 4.2.5** Failure to submit bid with Traffic Control and the category of work (Part II, III, or IV on ATT A) in its entirety will result in the disqualification of the bid, for the category of work bid.
- 4.2.6** Failure to provide Base of Operations information on ATT A will result in the disqualification of the entire bid.
- 4.2.7** Vendor should type or electronically enter the information into the Pricing Pages spreadsheet to prevent errors in the evaluation. In most cases, the Pricing Pages are available in wvOASIS within the solicitation attachments, however, Vendors may request an electronic copy of the Pricing Pages spreadsheet for bid purposes by sending an email request to the following address: DOTProcurement@wv.gov.

REQUEST FOR QUOTATION
Ditch, Pipe, and Asphalt Repair and Maintenance by the Vendor

4.2.8 Changing a column or row description, Contract Item description, or unit of measure on the **Pricing Pages, Attachment A (ATT A)**, shall result in disqualification of the Contract Item bid on the altered line. In circumstances when all Contract Items must be bid for bid evaluation and contract award, the disqualification of any Contract Item will result in the disqualification of the entire bid.

Submitting Pricing Pages other than those provided with this solicitation, as described in Section 4.2 shall result in the disqualification Vendor's bid in its entirety.

Vendor entries of bid prices or other notations made in wvOASIS commodity line descriptions will not be considered for bid evaluation or award.

4.3 Contract Award Transition: Upon award of this contract, the WVDOH Operations Division will announce the effective date of use of this contract to the Districts and the Vendors, whether it is by the effective date, the completed and encumbered date, or an established date by the WVDOH. Upon the announced effective date of use, any order issued prior to the award of the contract shall remain in effect and should not be cancelled until that order is filled; however, after 10 working days of the Districts and Vendors notice, any order that has not been completely filled by the Vendors shall NOT be completed and a cancellation notice will be sent to that Vendor from the issuing District for cancellation of the balance of that order only. No orders from prior contracts should be held open by the Districts or Vendors longer than 10 working days after the effective date of use is announced for the new contract.

5. ORDERING AND PAYMENT:

5.1 Ordering: Vendor shall accept orders through regular mail, facsimile, email, or any other written forms of communication. Vendor shall maintain and keep current its phone numbers, fax number, email address, locations, and ordering/billing/payment addresses with WVDOH and in wvOASIS. Vendor may, but is not required to, accept online orders through a secure internet ordering portal/website. If Vendor can accept online orders, it shall include in its response a brief description of how Agencies may utilize the online ordering system. Vendor shall ensure that its online ordering system is properly secured prior to processing Agency orders online.

5.2 Agency Delivery Order ("ADO"): District personnel must issue an ADO from wvOASIS for specific quantities of materials based on each project's requirements and detailing the need and location information of work to be completed per Contract Items, as well as the start and end dates, which will become the agreed

REQUEST FOR QUOTATION
Ditch, Pipe, and Asphalt Repair and Maintenance by the Vendor

upon official start and end dates. The ADO must be created in wvOASIS and approved to "Final", prior to placing the order with the Vendor. The District is responsible for creating the ADO in OASIS and is required to submit the approved order, in writing, directly to the vendor via mail, email or fax. **Verbal communication with the Vendor is not considered an official order.** In the event the Vendor denies an order or if there are changes to an ADO, the District must process a change order to the approved ADO issued from wvOASIS.

Emergencies shall be prominently noted on the ADO. Once complete, the ADO shall be sent to Vendor via fax, email, or mail.

5.2.1 Lead Time: The WVDOH should plan accordingly to allow the Contractor a minimum of 14 calendar days prior to the date of the agreed upon start date on the ADO to allow Vendor to mobilize and begin work.

5.3 Payment: Upon completion of the work indicated on the ADO, Vendor shall accept payment in accordance with the payment procedures of the State of West Virginia. The State of West Virginia currently utilizes a Purchasing Card program, administered under contract by a banking institution, as well as Electronic Funds Transfer as methods to process payment for goods and services. The Vendor shall accept the State of West Virginia's Purchasing Card and Electronic Funds Transfer for payment of orders under this Contract. Electronic Funds Transfer for payment is available through the WV State Auditor's Office. The Vendor may visit the WV State Auditor's website (wvsao.gov) for all necessary forms and instructions. Payment method may be dictated at WVDOH's discretion.

6. PROJECT ACCEPTANCE, DELIVERY AND RETURN:

6.1 Project Acceptance and Written Verification of Receipt: Upon receipt of a WVDOH ADO, the Vendor shall advise the WVDOH in writing within five (5) calendar days of their acceptance or refusal of the ADO. As verification of receipt, Vendor must provide written acknowledgement of any ADO and any Revisions/Modifications thereto sent by WVDOH. Failure to provide the WVDOH with written acknowledgement of any ADOs/Revisions within five (5) days of the Order being sent shall be considered refusal of the ADO. In the event of refusal, the WVDOH at its own discretion shall cancel the ADO and may seek to obtain the goods or services from the next low bid Vendor or proceed with an emergency purchase from the open market.

6.1.1 Negotiation of Dates: The WVDOH shall have the option to negotiate with the Vendor, the project's tentative start and end dates. **Project work shall be continuous to completion unless otherwise approved in writing by the WVDOH District Engineer or their designee.**

REQUEST FOR QUOTATION
Ditch, Pipe, and Asphalt Repair and Maintenance by the Vendor

- 6.2 Delivery Time:** In accordance with Section 6.1 and the terms of this contract, the work shall be scheduled by the WVDOH. The Vendor shall mobilize, commence, and complete work delivery in accordance with the WVDOH's written ADO, per project. Any changes must be communicated by the Vendor in writing to the WVDOH District Engineer or their designee. The Vendor shall work in an efficient manner in effort to keep traffic delay to a minimum and traffic must be adequately and safely accommodated. Vendor shall ship/provide all orders in accordance with the dates assigned to each project per the ADO and shall not hold orders until a minimum delivery quantity is met. **No Vendor is authorized to ship project related goods or begin work/services, nor is the WVDOH authorized to receive materials, prior to the issuance of an ADO.**
- 6.3 Adverse Weather Conditions:** Unsuitable/adverse/inclement weather conditions may dictate the work schedule. It is preferred that operations be suspended immediately when an inclement weather event begins or if the WVDOH District Engineer or their designee determines that an inclement weather event is imminent. If working conditions are dangerous or unsuitable for the WVDOH, Vendor, or general public, work shall be suspended by the WVDOH Engineer/designee. If needed, revision to the project's start and end date may be negotiated by the Vendor and the WVDOH Engineer/designee. After a weather-related suspension of work, the WVDOH District Engineer or their designee shall determine and convey in writing, such ADO changes and when work shall commence/resume, followed by the Vendor's written acknowledgement, per Section 6.4 of this Contract Solicitation.
- 6.4 Late Delivery:** The Agency placing the order under this Contract must be notified in writing if orders will be delayed for any reason. Any delay in delivery that could cause harm to an Agency will be grounds for cancellation of the delayed order, and/or obtaining the items ordered from another awarded vendor or proceed with an Emergency Purchase from the open market.

The Agency placing the ADO under this Contract must be notified **in writing by the Vendor no later than five (5) business days prior to the scheduled start date noted on the Agency's order.** Any failure to notify, acknowledge receipt of WVDOH's written ADOs/ Revisions resulting in delivery delay, or failure to start or complete the project per the WVDOH scheduled due dates may be determined by the WVDOH at its sole discretion as harmful to the Agency and as such, shall result in WVDOH's cancellation of the ADO and application of Liquidated Damages.

Any Agency seeking to obtain items from the open market under this provision must first obtain approval of the WVDOH Budget & Procurement Division.

6.4.1 Liquidated Damages: If the Vendor's work completion or corrections of

REQUEST FOR QUOTATION
Ditch, Pipe, and Asphalt Repair and Maintenance by the Vendor

deficient work exceeds the ADO completion due date or timeframe, the Vendor shall agree that no extension of contract time will be granted unless Liquidated Damages are applied by the WVDOH in the form of an off-set reduction to the total amount of the Vendor's final invoice. The WVDOH shall calculate Liquidated Damages per project beginning on day one (1) after the WVDOH's specified ADO due date and in accordance with this Section, the Contract's Terms and Conditions, Standard Specs Section 108.7, and the following Standard Specs Section Table 108.7.1 - Schedule of Liquidated Damages, as amended:

**Table 108.7.1
 Schedule of Liquidated Damages**

Original Contract Amount		Daily Charges Per Calendar Day
For More Than	To and Including	
\$0	\$500,000	\$350
\$500,000	\$2,000,000	\$650
\$2,000,000	\$10,000,000	\$1,600
\$10,000,000	\$25,000,000	\$3,100
\$25,000,000		\$4,200

6.4.2 Force Majeure: It shall be further noted that the Vendor is not responsible for and shall not be penalized for delays in its delivery of goods and/or services when caused by factors or events outside Vendor's control, including but not limited to acts or omissions of the Agency or third parties, acts of civil or military authority, civil disturbance, war, terrorism, pandemics, explosions, fire, floods, tornadoes, or other natural disasters or acts of God.

6.5 Delivery Payment/Risk of Loss: Standard order delivery shall be F.O.B. destination to the Agency's location. Vendor shall include the cost/discount of standard order delivery charges in its bid pricing and is not permitted to charge the Agency separately for such delivery. The Agency will pay delivery charges on all emergency orders provided that Vendor invoices those delivery costs as a separate charge with the original freight bill attached to the invoice.

Deliveries made by the vendor shall be comprised only of Contract Items intended for delivery at that location and specified in the pricing pages, contract specifications or ADO. At no time shall property belonging to the West Virginia Department of Transportation be utilized as a lay-down or storage facility by the vendor, or items left with the intention of being distributed to an alternate location.

6.6 Project Acceptance Criteria: The WVDOH District Engineer or their designee shall have final acceptance of the work done by the Vendor, per project. Any work found by the WVDOH District Engineer or their designee not performed in

REQUEST FOR QUOTATION
Ditch, Pipe, and Asphalt Repair and Maintenance by the Vendor

accordance with these contract specifications or the Standard Specs, as amended, and/or found deficient and unacceptable by visual inspection will be rejected and, at the Vendor's/Contractor's expense, will be removed and replaced by the Vendor with work being continual until the Vendor's deficient work corrections are completed and deemed acceptable and approved by the WVDOH District Engineer or their designee. Under no circumstance shall the Vendor's deficiency corrections exceed twenty (20) calendar days unless otherwise declared in writing by the WVDOH District Engineer or their designee and may be subject to Liquidated Damages as per Section 6.5.1 of these Contract Specifications.

- 6.7 Return of Unacceptable Items:** The decision of the WVDOH District Engineer or their designee regarding materials, workmanship, quality etc., shall be final per the Standard Specs Section 105.1, as amended. If the Agency deems the Contract Items to be unacceptable, the Contract Items shall be returned to Vendor at Vendor's expense and with no restocking charge. Vendor shall either arrange for the return within five (5) days of being notified that items are unacceptable or permit the Agency to arrange for the return and reimburse Agency for delivery expenses. If the original packaging cannot be utilized for the return, Vendor will supply the Agency with appropriate return packaging upon request. All returns of unacceptable items shall be F.O.B. the Agency's location. The returned product shall either be replaced, or the Agency shall receive a full credit or refund for the purchase price, at the Agency's discretion.
- 6.8 Return Due to Agency Error:** Items ordered in error by the Agency will be returned for credit within 30 days of receipt, F.O.B. Vendor's location. Vendor shall not charge a restocking fee if returned products are in a resalable condition. Items shall be deemed to be in a resalable condition if they are unused and in the original packaging. Any restocking fee for items not in a resalable condition shall be the lower of the Vendor's customary restocking fee or 5% of the total invoiced value of the returned items.

7. VENDOR DEFAULT:

- 7.1** The following shall be considered a vendor default under this Contract.
- 7.1.1** Failure to provide Contract Items in accordance with the requirements contained herein.
- 7.1.2** Failure to comply with other specifications and requirements contained herein.

REQUEST FOR QUOTATION
Ditch, Pipe, and Asphalt Repair and Maintenance by the Vendor

- 7.1.3 Failure to comply with any laws, rules, and ordinances applicable to the Contract Services provided under this Contract.
- 7.1.4 Failure to remedy deficient performance upon request.
- 7.2 The following remedies shall be available to Agency upon default.
 - 7.2.1 Immediate cancellation of the Contract.
 - 7.2.2 Immediate cancellation of one or more release orders issued under this Contract.
 - 7.2.3 Any other remedies available in law or equity.

8. MISCELLANEOUS:

- 8.1 **No Substitutions:** Vendor shall supply only Contract Items submitted in response to the Solicitation unless a contract modification is approved in accordance with the provisions contained in this Contract.
- 8.2 **Vendor Supply:** Vendor must carry sufficient inventory of the Contract Items being offered to fulfill its obligations under this Contract. By signing its bid, Vendor certifies that it can supply the Contract Items contained in its bid response.
- 8.3 **Reports:** Vendor shall provide the Agency with quarterly reports, annual summaries, and/or monthly reports as requested by the Agency and/or the West Virginia Purchasing Division showing quantities, total dollar value of the Contract Items purchased, ordered, shipped & invoiced with dates in spreadsheet format as defined by the Agency. Failure to supply such reports may be grounds for cancellation of this Contract.
- 8.4 **Contract Manager:** During its performance of this Contract, Vendor must designate and maintain a primary contract manager responsible for overseeing Vendor's responsibilities under this Contract. The Contract Manager must be available during normal business hours to address any customer service or other issues related to this Contract. Vendor should list its Contract Manager and his or her contact information below.

Contract Manager: David Lash
Telephone Number: 740-296-8009
Fax Number: 724-745-7778
Email Address: dlash@castandbaker.com

REQUEST FOR QUOTATION
Ditch, Pipe, and Asphalt Repair and Maintenance by the Vendor

Vendor shall inform the Agency in writing of any changes to the information provided above within 10 calendar days of such changes. Failure to comply may be grounds for cancellation of this contract.



CONTRACTOR LICENSE

AUTHORIZED BY THE
West Virginia Contractor
Licensing Board

NUMBER: WV004168

CLASSIFICATION:

GENERAL ENGINEERING
SPECIALTY
EXCAVATION

CAST & BAKER CORPORATION
2214 WASHINGTON RD
CANONSBURG, PA 15317-4914

DATE ISSUED

EXPIRATION DATE

SEPTEMBER 11, 2024

SEPTEMBER 11, 2025

Authorized Signature

Chair, West Virginia Contractor
Licensing Board



A copy of this license must be readily available for inspection by the Board on every job site where contracting work is being performed. This license number must appear in all advertisements, on all bid submissions, and on all fully executed and binding contracts. This license is non-transferable. This license is being issued under the provisions of West Virginia Code, Chapter 30, Article 42.

ATTACHMENT A PRICING PAGE (ATT A)

Vendor Instructions: Vendor shall provide their name and Base of Operations physical address applicable to ATT A in the spaces below. If the vendor has multiple Base of Operations location addresses, vendor may insert additional lines. Vendor shall then mark with an "X" the counties that correspond with the bid prices on this page. If Vendor has varied pricing per county, Vendor shall complete a separate set of Pricing Pages (ATT A) for each county pricing set. Vendor must bid all Traffic Control Contract Items in Part I below. Vendors may bid any or all categories of work in Part II, Part III, or Part IV below, but must bid all Contract Items within a category of work to be awarded a contract.

This is a multiple vendor award contract. All qualifying vendors meeting the contract specifications will be awarded with a contract. The low bid vendor per project will be determined at the time of need, as per Section 4.1 of the Contract Specifications. Estimated quantities are not available.

VENDOR'S NAME: Cast & Baker Corporation

Vendor's Base of Operations: 2214 Washington Road

(Please provide physical address): Canonsburg, PA 15317

<i>District 1</i>	<i>District 2</i>	<i>District 3</i>	<i>District 4</i>	<i>District 5</i>	<i>District 6</i>	<i>District 7</i>	<i>District 8</i>	<i>District 9</i>	<i>District 10</i>
<input type="checkbox"/> Boone	<input type="checkbox"/> Cabell	<input type="checkbox"/> Calhoun	<input type="checkbox"/> Doddridge	<input type="checkbox"/> Berkeley	<input checked="" type="checkbox"/> Brooke	<input type="checkbox"/> Barbour	<input type="checkbox"/> Pendleton	<input type="checkbox"/> Fayette	<input type="checkbox"/> McDowell
<input type="checkbox"/> Clay	<input type="checkbox"/> Lincoln	<input type="checkbox"/> Jackson	<input type="checkbox"/> Harrison	<input type="checkbox"/> Grant	<input checked="" type="checkbox"/> Hancock	<input type="checkbox"/> Braxton	<input type="checkbox"/> Pocahontas	<input type="checkbox"/> Greenbrier	<input type="checkbox"/> Mercer
<input type="checkbox"/> Kanawha	<input type="checkbox"/> Logan	<input type="checkbox"/> Pleasants	<input type="checkbox"/> Marion	<input type="checkbox"/> Hampshire	<input checked="" type="checkbox"/> Marshall	<input type="checkbox"/> Gilmer	<input type="checkbox"/> Randolph	<input type="checkbox"/> Monroe	<input type="checkbox"/> Raleigh
<input type="checkbox"/> Mason	<input type="checkbox"/> Mingo	<input type="checkbox"/> Ritchie	<input type="checkbox"/> Monongalia	<input type="checkbox"/> Hardy	<input checked="" type="checkbox"/> Ohio	<input type="checkbox"/> Lewis	<input type="checkbox"/> Tucker	<input type="checkbox"/> Nicholas	<input type="checkbox"/> Wyoming
<input type="checkbox"/> Putnam	<input type="checkbox"/> Wayne	<input type="checkbox"/> Roane	<input type="checkbox"/> Preston	<input type="checkbox"/> Jefferson	<input checked="" type="checkbox"/> Tyler	<input type="checkbox"/> Upshur		<input type="checkbox"/> Summers	
		<input type="checkbox"/> Wirt	<input type="checkbox"/> Taylor	<input type="checkbox"/> Mineral	<input checked="" type="checkbox"/> Wetzell	<input type="checkbox"/> Webster			
		<input type="checkbox"/> Wood		<input type="checkbox"/> Morgan					

Part I - Traffic Control *required

Contract Item #	Contract Item Description	Unit of Measure	List Price
1	Pilot Truck and Driver	Day	\$1,000.00
2	Traffic Control Devices	Unit	\$5.25
3	Flagger	Hour	\$150.00
4	Arrow Board	Day	\$95.00

ATTACHMENT A PRICING PAGE (ATT A)

VENDOR'S NAME: Cast & Baker Corporation

Vendor's Base of Operations: 2214 Washington Road

(Please provide physical address): Canonsburg, PA 15317

<i>District 1</i>	<i>District 2</i>	<i>District 3</i>	<i>District 4</i>	<i>District 5</i>	<i>District 6</i>	<i>District 7</i>	<i>District 8</i>	<i>District 9</i>	<i>District 10</i>
<input type="checkbox"/> Boone	<input type="checkbox"/> Cabell	<input type="checkbox"/> Calhoun	<input type="checkbox"/> Doddridge	<input type="checkbox"/> Berkeley	<input checked="" type="checkbox"/> Brooke	<input type="checkbox"/> Barbour	<input type="checkbox"/> Pendleton	<input type="checkbox"/> Fayette	<input type="checkbox"/> McDowell
<input type="checkbox"/> Clay	<input type="checkbox"/> Lincoln	<input type="checkbox"/> Jackson	<input type="checkbox"/> Harrison	<input type="checkbox"/> Grant	<input checked="" type="checkbox"/> Hancock	<input type="checkbox"/> Braxton	<input type="checkbox"/> Pocahontas	<input type="checkbox"/> Greenbrier	<input type="checkbox"/> Mercer
<input type="checkbox"/> Kanawha	<input type="checkbox"/> Logan	<input type="checkbox"/> Pleasants	<input type="checkbox"/> Marion	<input type="checkbox"/> Hampshire	<input checked="" type="checkbox"/> Marshall	<input type="checkbox"/> Gilmer	<input type="checkbox"/> Randolph	<input type="checkbox"/> Monroe	<input type="checkbox"/> Raleigh
<input type="checkbox"/> Mason	<input type="checkbox"/> Mingo	<input type="checkbox"/> Ritchie	<input type="checkbox"/> Monongalia	<input type="checkbox"/> Hardy	<input checked="" type="checkbox"/> Ohio	<input type="checkbox"/> Lewis	<input type="checkbox"/> Tucker	<input type="checkbox"/> Nicholas	<input type="checkbox"/> Wyoming
<input type="checkbox"/> Putnam	<input type="checkbox"/> Wayne	<input type="checkbox"/> Roane	<input type="checkbox"/> Preston	<input type="checkbox"/> Jefferson	<input checked="" type="checkbox"/> Tyler	<input type="checkbox"/> Upshur		<input type="checkbox"/> Summers	
		<input type="checkbox"/> Wirt	<input type="checkbox"/> Taylor	<input type="checkbox"/> Mineral	<input checked="" type="checkbox"/> Wetzel	<input type="checkbox"/> Webster			
		<input type="checkbox"/> Wood		<input type="checkbox"/> Morgan					

Part II - Ditching Maintenance & Repair

Contract Item #	Contract Item Description	Unit of Measure	List Price
5	Ditching	Shoulder Mile	\$20,000.00
6	Correcting Deep Ditches	Ton	\$380.00
7	Restoring Shoulders and Shoulder Stone	Ton	\$460.00
8	Shoulder Stone Placement	Ton	\$300.00
9	Ditching Haul by Vendor for Contract Items 6, 7 & 8, First Ton Mile	Ton Mile	\$7.50
10	Ditching Haul by Vendor for Contract Items 6, 7 & 8, Each Additional Mile	Ton Mile	\$0.75
11	Ditching Waste Haul by Vendor per truck/driver	Hour	\$150.00
12	Daytime Mobilization	Lump Sum	\$2,500.00
13	Nighttime Mobilization	Lump Sum	\$5,000.00
14	On-Site Mobilization	Lump Sum	\$1,000.00

Part III - Pipe Repair & Replacement

Contract Item #	Contract Item Description	Unit of Measure	List Price
15	15" Type F Trench	Linear Foot	\$125.00
16	18" Type F Trench	Linear Foot	\$125.00
17	24" Type F Trench	Linear Foot	\$125.00
18	30" Type F Trench	Linear Foot	\$125.00
19	36" Type F Trench	Linear Foot	\$150.00
20	42" Type F Trench	Linear Foot	\$250.00
21	48" Type F Trench	Linear Foot	\$250.00
22	54" Type F Trench	Linear Foot	\$250.00

ATTACHMENT A PRICING PAGE (ATT A)

VENDOR'S NAME: Cast & Baker Corporation

Vendor's Base of Operations: 2214 Washington Road

(Please provide physical address): Canonsburg, PA 15317

<i>District 1</i>	<i>District 2</i>	<i>District 3</i>	<i>District 4</i>	<i>District 5</i>	<i>District 6</i>	<i>District 7</i>	<i>District 8</i>	<i>District 9</i>	<i>District 10</i>
<input type="checkbox"/> Boone	<input type="checkbox"/> Cabell	<input type="checkbox"/> Calhoun	<input type="checkbox"/> Doddridge	<input type="checkbox"/> Berkeley	<input checked="" type="checkbox"/> Brooke	<input type="checkbox"/> Barbour	<input type="checkbox"/> Pendleton	<input type="checkbox"/> Fayette	<input type="checkbox"/> McDowell
<input type="checkbox"/> Clay	<input type="checkbox"/> Lincoln	<input type="checkbox"/> Jackson	<input type="checkbox"/> Harrison	<input type="checkbox"/> Grant	<input checked="" type="checkbox"/> Hancock	<input type="checkbox"/> Braxton	<input type="checkbox"/> Pocahontas	<input type="checkbox"/> Greenbrier	<input type="checkbox"/> Mercer
<input type="checkbox"/> Kanawha	<input type="checkbox"/> Logan	<input type="checkbox"/> Pleasants	<input type="checkbox"/> Marion	<input type="checkbox"/> Hampshire	<input checked="" type="checkbox"/> Marshall	<input type="checkbox"/> Gilmer	<input type="checkbox"/> Randolph	<input type="checkbox"/> Monroe	<input type="checkbox"/> Raleigh
<input type="checkbox"/> Mason	<input type="checkbox"/> Mingo	<input type="checkbox"/> Ritchie	<input type="checkbox"/> Monongalia	<input type="checkbox"/> Hardy	<input checked="" type="checkbox"/> Ohio	<input type="checkbox"/> Lewis	<input type="checkbox"/> Tucker	<input type="checkbox"/> Nicholas	<input type="checkbox"/> Wyoming
<input type="checkbox"/> Putnam	<input type="checkbox"/> Wayne	<input type="checkbox"/> Roane	<input type="checkbox"/> Preston	<input type="checkbox"/> Jefferson	<input checked="" type="checkbox"/> Tyler	<input type="checkbox"/> Upshur		<input type="checkbox"/> Summers	
		<input type="checkbox"/> Wirt	<input type="checkbox"/> Taylor	<input type="checkbox"/> Mineral	<input checked="" type="checkbox"/> Wetzell	<input type="checkbox"/> Webster			
		<input type="checkbox"/> Wood		<input type="checkbox"/> Morgan					

Contract Item #	Contract Item Description	Unit of Measure	List Price
23	60" Type F Trench	Linear Foot	\$250.00
24	Pipe Repair/Replacement backfill for F Trench (material + delivery first 5 miles)	Cubic Yard	\$475.00
25	Additional Haul per truck load over 5 miles, Backfill for F Trench	Mile	\$9.00
26	Safe Access and Egress Surcharge depth of 5-foot to 10-foot	Lump Sum	\$2,750.00
27	Safe Access and Egress Surcharge depth of 10-foot to 15-foot	Lump Sum	\$5,500.00
28	Safe Access and Egress Surcharge depth 15-foot to 20-foot	Lump Sum	\$6,800.00
29	Pipe Repair/Replacement Waste Haul by Vendor per truck/driver	Hour	\$150.00
30	Daytime Mobilization	Lump Sum	\$2,500.00
31	Nighttime Mobilization	Lump Sum	\$5,000.00
32	On-Site Mobilization	Lump Sum	\$750.00

Part IV - Asphalt Pavement Repair

Contract Item #	Contract Item Description	Size of Project, per Mile	Unit of Measure	List Price
33	Pothole Repair	0-50 SY	Mile	\$11,500.00
34		51-250 SY		\$12,100.00
35		251-500 SY		\$19,500.00
36		501 SY or greater		\$32,500.00

ATTACHMENT A PRICING PAGE (ATT A)

VENDOR'S NAME: Cast & Baker Corporation

Vendor's Base of Operations: 2214 Washington Road

(Please provide physical address): Canonsburg, PA 15317

<i>District 1</i>	<i>District 2</i>	<i>District 3</i>	<i>District 4</i>	<i>District 5</i>	<i>District 6</i>	<i>District 7</i>	<i>District 8</i>	<i>District 9</i>	<i>District 10</i>
<input type="checkbox"/> Boone	<input type="checkbox"/> Cabell	<input type="checkbox"/> Calhoun	<input type="checkbox"/> Doddridge	<input type="checkbox"/> Berkeley	<input checked="" type="checkbox"/> Brooke	<input type="checkbox"/> Barbour	<input type="checkbox"/> Pendleton	<input type="checkbox"/> Fayette	<input type="checkbox"/> McDowell
<input type="checkbox"/> Clay	<input type="checkbox"/> Lincoln	<input type="checkbox"/> Jackson	<input type="checkbox"/> Harrison	<input type="checkbox"/> Grant	<input checked="" type="checkbox"/> Hancock	<input type="checkbox"/> Braxton	<input type="checkbox"/> Pocahontas	<input type="checkbox"/> Greenbrier	<input type="checkbox"/> Mercer
<input type="checkbox"/> Kanawha	<input type="checkbox"/> Logan	<input type="checkbox"/> Pleasants	<input type="checkbox"/> Marion	<input type="checkbox"/> Hampshire	<input checked="" type="checkbox"/> Marshall	<input type="checkbox"/> Gilmer	<input type="checkbox"/> Randolph	<input type="checkbox"/> Monroe	<input type="checkbox"/> Raleigh
<input type="checkbox"/> Mason	<input type="checkbox"/> Mingo	<input type="checkbox"/> Ritchie	<input type="checkbox"/> Monongalia	<input type="checkbox"/> Hardy	<input checked="" type="checkbox"/> Ohio	<input type="checkbox"/> Lewis	<input type="checkbox"/> Tucker	<input type="checkbox"/> Nicholas	<input type="checkbox"/> Wyoming
<input type="checkbox"/> Putnam	<input type="checkbox"/> Wayne	<input type="checkbox"/> Roane	<input type="checkbox"/> Preston	<input type="checkbox"/> Jefferson	<input checked="" type="checkbox"/> Tyler	<input type="checkbox"/> Upshur		<input type="checkbox"/> Summers	
		<input type="checkbox"/> Wirt	<input type="checkbox"/> Taylor	<input type="checkbox"/> Mineral	<input checked="" type="checkbox"/> Wetzell	<input type="checkbox"/> Webster			
		<input type="checkbox"/> Wood		<input type="checkbox"/> Morgan					

Part IV - Asphalt Pavement Repair (continued)

Contract Item #	Contract Item Description	Size of Project, per Mile	Unit of Measure	List Price
37	Base Failure Repair, Asphalt	0-50 SY	Mile	\$22,000.00
38		51-250 SY		\$23,000.00
39		251-500 SY		\$43,000.00
40		501 SY or greater		\$67,000.00
41	Base Failure Repair, Stone	0-50 SY	Mile	\$21,600.00
42		51-250 SY		\$25,750.00
43		251-500 SY		\$47,100.00
44		501 SY or greater		\$119,000.00
45	Edge Failure Repair	0-50 SY	Mile	\$28,600.00
46		51-250 SY		\$26,250.00
47		251-500 SY		\$66,000.00
48		501 SY or greater		\$128,000.00
49	Haul by Vendor First Ton Mile	-----	Ton Mile	\$7.50
50	Haul by Vendor Each Additional Mile	-----	Ton Mile	\$0.75
51	Waste Haul by Vendor per truck/driver	-----	Hour	\$150.00
52	Off-Season Plant Opening First Day	-----	Day	\$9,000.00
53	Off-Season Plant Opening Each Additional Day	-----	Day	\$3,500.00
54	Daytime Mobilization	-----	Lump Sum	\$2,500.00
55	Nighttime Mobilization	-----	Lump Sum	\$5,000.00
56	On-Site Mobilization	-----	Lump Sum	\$1,175.00