

# **AGGREGATE TECHNICIAN INSTRUCTION MANUAL**

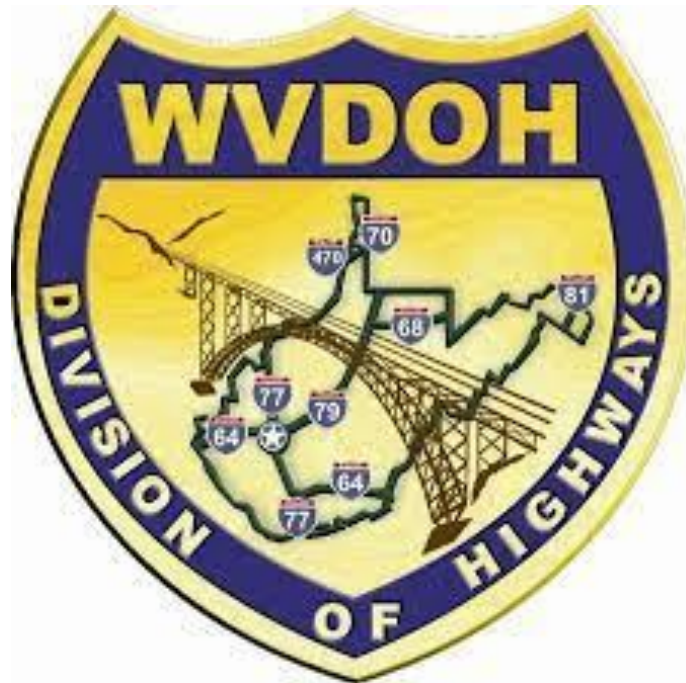



# AGGREGATE TECHNICIAN INSTRUCTION MANUAL

<u>TABLE OF CONTENTS</u>	<u>PAGE</u>
Table of Contents	I to V
Study Guide for Aggregate Technician Certification	VI
<u>Contents</u>	
1.00 <u>Introduction</u>	
1.01 Purpose	VI
1.02 Scope	VI
2.00 <u>Study Outline</u>	
2.01 Study Outline for Aggregate	VII
3.00 <u>Examination</u>	
3.01 General	VIII
3.02 Types of Questions	VIII
4.00 <u>Sample Questions</u>	
4.01 Aggregate Questions	IX
5.00 <u>References</u>	
5.01 Materials Letters	XIV
5.02 Materials Procedures	XIV
5.03 Specifications	XIV
5.04 Division of Highways Construction Manual	XIV
6.00 <u>Answers to Sample Questions</u>	
6.01 Part I Aggregates	XV
Practical Study Guide	XVI
Manual Instructions	XXII

TABLE OF CONTENTS (CONT'D):

PAGE

<b><u>Chapter 1:</u></b>	<b><u>GENERAL INFORMATION</u></b> .....	1-1 to 1-26
	Definitions.....	1-1
	Rock Cycle.....	1-3
	Properties and Characteristics.....	1-7
	Shape and Surface Texture.....	1-10
	Gradation Analysis.....	1-11
	Nominal Maximum Size.....	1-17
	Fineness Modulus.....	1-20
	Atterberg Limits.....	1-20
	Rounding Procedures .....	1-20
	Terminology for Balances and Scales.....	1-21
	Summary.....	1-22
	AASHTO M43.....	1-23
	Table 2 (704.6.2A).....	1-24
	Fine Aggregate Alternate Grading.....	1-25
	Characteristics of Aggregates.....	1-26
<b><u>Chapter 2:</u></b>	<b><u>SAMPLING METHODS AND EQUIPMENT</u></b> .....	2-1 to 2-24
	Introduction.....	2-1
	Sampling Procedures.....	2-1
	The Importance of Randomization.....	2-1
	MP700.00.06 - Aggregate Sampling Procedures.....	2-2
	Roadway Sampling.....	2-4
	Shoulder Sampling.....	2-6
	Conveyor Belt Sampling.....	2-7
	Stockpile Sampling.....	2-8
	Planning the Sampling Program.....	2-11
	Exercises.....	2-12
	Random Number Chart.....	2-23
<b><u>Chapter 3:</u></b>	<b><u>SIEVE ANALYSIS, <math>\bar{A}</math>, AND ACCEPTANCE PROCEDURES</u></b> .....	3-1 to 3-93
	<b>Part I - Introduction to Gradations</b> .....	3-1
	Blank T300.....	3-9
	Simple Gradation Exercise.....	3-10
	<b>Part II - Coarse Aggregate Gradations</b> .....	3-13
	T 11 Wash Test.....	3-18
	Thoroughness of Sieving.....	3-20
	Hand Sieving Worksheet.....	3-21
	Maximum Weights on Sieves.....	3-24
	Exercises.....	3-30
	<b>Part III - Fine Aggregate Gradations</b> .....	3-40



<u>TABLE OF CONTENTS (CONT'D):</u>		<u>PAGE</u>
T 11 Wash Test.....		3-41
Exercises.....		3-49
<b>Part IV - Sieve Analysis of Material Containing a Combination of Coarse And Fine Aggregate.</b>		3-58
Correction Factor.....		3-64
Exercises.....		3-70
<b>Part V - Development And Use of <math>\bar{A}</math> (A-bar) Factors</b>		3-79
Table of Common $\bar{A}$ Sieves.....		3-80
<b>Part VI - Materials Acceptance Procedures.....</b>		3-88
Standard and Metric Sieve Size Equivalents.....		3-91
<b><u>Chapter 4:</u> <u>SPECIFIC GRAVITY</u>.....</b>	4-1	to 4-36
<b>Part I - Introduction.....</b>		4-1
Saturated-Surface-Dry (SSD).....		4-5
Absorption.....		4-6
<b>Part II - Specific Gravity of Fine Aggregate.....</b>		4-8
Exercises.....		4-17
<b>Part III - Specific Gravity of Coarse Aggregate.....</b>		4-23
Exercises.....		4-29
<b><u>Chapter 5:</u> <u>UNIT WEIGHT</u>.....</b>	5-1	to 5-24
General Information.....		5-1
Measure Correction Factor.....		5-3
Water Temperature/Density Chart.....		5-4
Measure Selection Table.....		5-7
Procedure Selection.....		5-8
Rodding Procedure.....		5-8
Jigging Procedure.....		5-9
Shoveling Procedure.....		5-9
Exercises.....		5-12
<b><u>Chapter 6:</u> <u>LIQUID LIMIT, PLASTIC LIMIT, AND PLASTICITY INDEX</u>.....</b>	6-1	to 6-33
Definitions.....		6-1
The Three Point Method.....		6-4
The Flow Curve.....		6-11
Exercises.....		6-14
Liquid Limit One Point Method.....		6-23
Plastic Limit.....		6-27
Exercises.....		6-30
Plasticity Index.....		6-31

<u>TABLE OF CONTENTS (CONT'D):</u>		<u>PAGE</u>
<b><u>Chapter 7:</u></b>	<b><u>PERCENT CRUSHED PARTICLES</u></b> .....	7-1 to 7-17
	<b>Test Method: MP 703.00.21 (Appendix A-57)</b>	
	Definitions.....	7-1
	Calculations.....	7-5
	Test Portion Masses.....	7-8
	Exercises.....	7-10
<b><u>Chapter 8:</u></b>	<b><u>CONTROL CHARTS</u></b> .....	8-1 to 8-21
	<b>MP 300.00.51 (Appendix A-20)</b>	
	Introduction.....	8-1
	Exercises.....	8-6
<b><u>APPENDIX</u></b> .....		A1 to A-73
	Index.....	A-1
	Specification For Testing Aggregate.....	A-2
	Test To Be Performed.....	A-3
	Conversion Data.....	A-4
	Quality Control Plan Example.....	A-5 to A-6
ML-25	Procedure for Monitoring the Activities Related to Sieve Analysis of Fine and Coarse Aggregate.....	A-7 to A-11
MP 106.03.50	General Information Guide for Quality Assurance Testing.....	A-12 to A-19
MP 300.00.51	Procedural Guidelines For Maintaining Control Charts for Aggregate Gradation.....	A-20 to A-26
MP 307.00.50	Guide for Quality Control and Acceptance Plans for Subgrade, Base Course, and Aggregate Items.....	A-27 to A-32
MP 601.03.51	Standard Method for Determination of $\bar{A}$ of the Total Solids in Portland Cement Concrete.....	A-33 to A-37

MP 700.00.06	Aggregate Sampling Procedures.....	A-39 to A-48
MP 700.00.54	Procedure for Evaluating Quality Control Sample Test Results with Verification Sample Test Results.....	A-49 to A-56
MP 703.00.21	Standard Method of Test for Percent Crushed Particles.....	A-57 to A-60
T300	Sieve Analysis of Aggregate Worksheet	A-61
T301	$\bar{A}$ Calculation Worksheet	A-62
T302	Face Fracture Worksheet	A-63
T303	Calibration of Unit Weight Measure Worksheet	A-64
T304	Unit Weight of Aggregate Worksheet	A-65
T305	Specific Gravity of Fine Aggregate Worksheet	A-66
T306	Specific Gravity of Coarse Aggregate Worksheet	A-67
T307	Liquid Limit, Plastic Limit, and Plasticity Index Worksheet	A-68
T307	- Graph for Liquid Limit Determination	A-69
T100	- Test Sample Data Form	A-70
Table 700.3,	2002 Construction Manual	A-71 to A-73

# **EXAM STUDY GUIDE FOR AGGREGATE TECHNICIAN CERTIFICATION**

## 1.00 INTRODUCTION

### 1.01 Purpose

The purpose of this study guide is to serve as a review and reference for Contractor, Producer, and State personnel preparing to take the Aggregate Technician Certification examination.

The questions and problems contained in this study guide should be typical of those that will be given in the examination.

In addition to questions and problems, the study guide contains a course study outline and a list of pertinent references.

### 1.02 Scope

Specific areas required for certification are:

- (1) Aggregate Specifications and Procedures - Basic questions on required quality tests, specification requirements from the WV Standard Specifications and procedure questions on various tests from AASHTO, the Aggregate Manual and Materials Procedures.
- (2) Aggregate Fundamentals and Techniques - Basic questions on materials, tools of the trade, sampling, and testing.

## **WEST VIRGINIA DIVISION OF HIGHWAYS**

### **2.00 STUDY OUTLINE FOR AGGREGATE TECHNICIAN CERTIFICATION**

The following is a general study outline covering the specific area required for certification.

#### **2.01 Aggregate Specifications and Procedures**

Specifications and procedures references are listed on page 14 of this study guide.

#### **2.02 Aggregate Fundamentals and Techniques**

##### **A. Basic Concepts**

1. Definitions (Rock Types)
2. Conditions of Quality

##### **B. Characteristics of Aggregates**

1. Hardness
2. Particle Shape and Surface Texture
3. Grading (Coarse and Fine)
4. Unit Weight
5. Specific Gravity (Coarse and Fine)
6. Absorption and Surface Moisture
7. Deleterious
8. Liquid & Plastic Limit & Plasticity Index

##### **C. Effects of Physical Characteristics**

1. Resistance to Abrasion
2. Durability
3. Compaction Capabilities
4. Workability in Fresh Concrete

##### **D. Sampling Methods, Equipment and Storage of Aggregates**

1. Types and Sizes of Aggregates
1. Crushing
2. Stockpiling
3. Random Sampling
4. Records
5. Apparatus for Sampling From:
  - a. Roadway
  - b. Conveyor Belt
  - c. Shoulder

#### E. Control

1. Scales
  - a. Accuracy Tests
2. Charts
3. Evaluations
4. Monitoring

### 3.0 **EXAMINATION**

#### 3.01 General

The examination will be given in two parts. The first is a written examination and the second is a practical examination.

Only those people passing the written part will be eligible for the practical. A successful completion of both the written and practical examinations will result in the technician becoming certified. A minimum of 70% is required to successfully complete the written part of the program. A competent completion of all eight tests for the practical part of the program is required.

#### 3.02 Types of Questions Found in the Written Examination

All questions are multiple choice. The examination is an open book test. You may bring books and reference material and refer to them during the examination.

### 4.0 **SAMPLE QUESTIONS AND PROBLEMS**

The following questions and problems are typical of those that will be given on the examination. It is recommended that candidates work the following sample test prior to attending the examination as a practice exercise. Answers can be found at the back of the study guide.

#### 4.01 Aggregate Questions

1. In accordance with MP700.00.06, a "Sampling Unit" is defined as:
  - (a) A composite of five increments
  - (b) The quantity of material within the subplot from which increments are obtained to be combined into a field sample.
  - (c) The material split out of a field sample to be used in performing a specific test.
  - (d) None of the above
  
2. You are sampling an AASHTO Size No. 78 Aggregate. The minimum field sample mass required for this size is:
  - (a) 30 kg
  - (b) 25 kg
  - (c) 50 kg
  - (d) 15 kg
  
3. You are to conduct a specific gravity test on fine aggregate. The test portion removed from the saturated-surface-dry material must weigh:
  - (a)  $500 \pm 10$  g
  - (b) approximately 500 g
  - (c) approximately 1000 g
  - (d)  $1000 \pm 10$ g
  
4. Given the following information, calculate the unit weight:

Weight of aggregate and measure, g	32,000
Weight of measure, g	9,300
Weight of water at 62 °F to fill measure, g	14,300
Density of water at 62 °F, lb/ft <sup>3</sup>	62.354

- (a) 145 lb/ft<sup>3</sup>
- (b) 70 lb/ft<sup>3</sup>
- (c) 99 lb/ft<sup>3</sup>
- (d) 102 lb/ft<sup>3</sup>

5. The centerline of a roadway extends from Station 20+00 to 30+00. Using random number 0.250, locate a random station along the centerline.
- (a) 22+50
  - (b) 25+00
  - (c) 26+50
  - (d) 27+50
6. Given the following information from a specific gravity test on fine aggregate:
- |   |       |
|---|-------|
| SSD weight of sand, g                                 | 510.0 |
| Weight of pycnometer, sample, and water, g            | 975.5 |
| Weight of pycnometer and water to calibration mark, g | 655.0 |
| Weight of oven-dry sand, g                            | 490.0 |
- 6.1 Find the bulk specific gravity (oven-dry)
- (a) 4.08
  - (b) 2.59
  - (c) 2.69
  - (d) 3.51
- 6.2 Find the bulk specific gravity (SSD Basis).
- (a) 4.08
  - (b) 2.58
  - (c) 2.69
  - (d) 3.57
- 6.3 Find the percent absorption
- (a) 4.1
  - (b) 2.6
  - (c) 2.7
  - (d) 1.2
7. Of the following and according to the West Virginia Standard Specifications, which would have the most detrimental effect on a non-stabilized base course?
- (a) 5% minus No. 200 material
  - (b) 10% sodium sulfate soundness loss
  - (c) 1% shale
  - (d) 55% abrasion loss



8. Durability of an aggregate usually indicates its ability to resist:
- (a) Abrasion
  - (b) Freezing and Thawing
  - (c) Segregation
  - (d) Absorption
9. Fine aggregate is generally considered as being predominately:
- (a) Smaller than the No. 10 screen
  - (b) Minus No.200 material
  - (c) Minus No. 4 material
  - (d) Minus No. 40 material
10. Given the following information from a specific gravity test on coarse aggregate:
- |                      |      |
|----------------------|------|
| SSD weight in air, g | 5000 |
| Weight in water, g   | 2000 |
| Oven-dry weight, g   | 4900 |
- 10.1 Find the bulk specific gravity (SSD)
- (a) 1.67
  - (b) 2.60
  - (c) 2.04
  - (d) 2.71
- 10.2 Find the percent absorption
- (a) 1.7
  - (b) 2.6
  - (c) 0.9
  - (d) 2.0
11. Convert the following metric and/or standard units into the indicated units. (In all cases round to the nearest whole number).
- 11.1 529 oz to kg
- (a) 15 kg
  - (b) 192 kg
  - (c) 12 kg
  - (d) 19.2 kg

11.2 -13°F to °C

- (a) -4°C
- (b) -36°C
- (c) -25°C
- (d) +25°C

11.3 76 mm to inches

- (a) 4 inches
- (b) 3 inches
- (c) 5 inches
- (d) 7.6 inches

11.4 90 kg to lb

- (a) 41 lb
- (b) 198 lb
- (c) 141 lb
- (d) 19.8 lb

12. Which of the following sieves is not used in calculating the  $\bar{A}$  of the total solids in Portland Cement Concrete?

- (a) No. 30
- (b) No. 40
- (c) No. 50
- (d) No. 100

13. The mix design  $\bar{A}$  tolerance for a No. 8 limestone used in Class B structural concrete is:

- (a)  $\pm 0.35$
- (b)  $\pm 0.25$
- (c)  $\pm 0.15$
- (d) No  $\bar{A}$  required for this type of concrete

14. When conducting a face fracture test, what size sample should be used if the nominal maximum size of the crushed gravel is 3/4 in?

- (a) approximately 2000 g
- (b) exactly 1500 g
- (c) minimum of 1500 g
- (d) approximately 1500 g

15. The difference between AASHTO T 11 Method A and B is:
- (a) Method A uses a wetting agent
  - (b) Method B uses a wetting agent
  - (c) A wetting agent is strictly optional
  - (d) Method A if for fine aggregate, Method B for coarse aggregate
16. When developing a Quality Control Plan for a base course item, the Materials Procedure suggests that the gradation test results be completed in about \_\_\_\_ hours after the sample is taken.
- (a) 120 hours
  - (b) 72 hours
  - (c) 48 hours
  - (d) There is no set time frame

## 5.00 REFERENCES

A knowledge of the following directives and memoranda is essential to the proper performance of the Certified Aggregate Technician. These memoranda and others relating to the quality control of aggregates should be maintained in a current status and carefully reviewed at frequent intervals.

### 5.01 Materials Letters:

ML-25                      Monitoring the Activities Related to Sieve Analysis of Fine and Coarse Aggregate

### 5.02 Materials Procedures:

MP-300.00.51            Procedural Guidelines for Maintaining Control Charts for Aggregate Gradation

MP-307.00.50            Guide for Quality Control and Acceptance Plans for Base Course

MP-601.03.51            Standard Method for Determination of  $\bar{A}$  of the Total Solids in Portland Cement Concrete

MP-700.00.06            Aggregate Sampling Procedure

MP-703.00.21            Method of Test for Percent Crushed Particles

### 5.03 Specifications:

West Virginia Standard Specifications. The American Association of State Highway and Transportation Officials (AASHTO) Parts I and II. The American Society for Testing and Materials (ASTM) Volume 4.02.

### 5.04 Manuals:

Division of Highways Construction Manual.

## **6.0 ANSWERS TO SAMPLE QUESTIONS**

### 6.01 Part 1 - Aggregates

1. Answer - (b)
2. Answer - (d)
3. Answer - (a)
4. Answer - (c)
5. Answer - (a)
- 6.1 Answer - (b)
- 6.2 Answer - (c)
- 6.3 Answer - (a)
7. Answer - (d)
8. Answer - (b)
9. Answer - (c)
- 10.1 Answer - (a)
- 10.2 Answer - (d)
- 11.1 Answer - (a)
- 11.2 Answer - (c)
- 11.3 Answer - (b)
- 11.4 Answer - (b)
12. Answer - (b)
13. Answer - (c)
14. Answer - (d)
15. Answer - (b)
16. Answer - (b)

## 7.0 **PRACTICAL STUDY GUIDE**

This guide is only intended as an aid in explaining what will be expected on the practical. All tests are based on AASHTO, ASTM or WVDOH Material Procedures.

**This list is not a substitute for knowing the procedures.**

Steps are **generally** listed for each procedure.

### **Gradation Analysis- AASHTO T 27:**

You will have to perform a partial gradation analysis on a coarse aggregate AASHTO # 57 aggregate. It will be a sample at the post T 11 oven dried stage and ready to dry sieve. You will have to explain the preparation steps including:

- Specification Sieve Determination
- Test Portion Size Determination
- Splitting
- Oven Drying
- Cooling
- T 11 Testing (you will be given a pre T 11 weight to use in the calculations)
- Post T 11 Oven Drying
- Cooling

You will perform the test from this point onward including:

- Post T 11 weighing
- Nesting the sieves in the mechanical shaker
- Introducing the sample without loss
- Shaking the sample
- Weighing material on each sieve and the pan (the pan weight will be adjusted by the instructor to allow for material retained on the No. 200 sieve)

You will have to complete the calculations on the T300 and evaluate the sample for specification compliance including No. 200 specs

You will also have to answer questions pertaining to the procedure and explain how to perform a combination gradation.

### **Wash Test - AASHTO T 11:**

You will be given a sample of fine aggregate for concrete ready for T 11 testing. You will have to test the sample for compliance with the specification for -No.200 material. You will have to talk through the preparation steps including:

- Sample size determination
- Splitting
- Oven Drying
- Cooling

You will have to complete the test from this point on including:

- Weighing
- Selecting and nesting sieves in correct order
- Introducing the sample into the container
- Adding wetting agent
- Washing the sample
- Deciding when test is complete
- Cleaning sieves
- Returning all material into drying pan

You will have to talk through steps from this point including:

- Oven drying
- Cooling
- Weighing (you will be given this weight by the instructor)
- Complete the calculations and evaluate the sample against specifications

### **Coarse Specific Gravity - AASHTO T 85:**

You will be given an AASHTO # 57 aggregate to conduct a coarse specific gravity. The sample will be prepared to the end of the soaking period and you will have to talk through the sample prep including:

- Test portion size determination
- Sample splitting
- Washing
- Oven drying
- Cooling
- Soaking

You will have to complete the test from here including:

- Preparing the equipment setup
- Decanting the water
- Drying the sample to SSD
- Weighing in air
- Weighing in water

You will have to talk through the final steps including:

- Oven drying
- Cooling
- Weighing

You will have to complete the calculations.

#### **Fine Aggregate Specific Gravity - AASHTO T 84:**

You will be given a fine aggregate and must complete the test from the point of drying the sample to SSD condition. You will have to talk through sample prep steps including:

- Test portion size
- Sample splitting
- Oven drying
- Soaking – both options
- Calibrating pycnometer

You will have to complete the steps from this point including:

- Drying the sample
- Cone test
- Determining proper SSD condition
- Weighing in air
- Introducing sample into pycnometer
- Filling with water
- Eliminating air
- Adjusting temp (this can be talked through)
- Filling the pycnometer
- Weighing pycnometer, sample and water
- Removing material from the pycnometer



You will have to talk through the remaining steps including:

- Oven drying
- Cooling
- Weighing

You will have to complete the calculations.

**Liquid and Plastic Limits - AASHTO T 89 & AASHTO T 90:**

You will be given a prepared sample to complete the Liquid and Plastic Limits tests.

**Liquid Limit:**

You will have to talk through the sample preparation steps including:

- Drying
- Breaking clumps
- Sieving
- Test portion size determination
- Weighing

You will have to complete the test from this point including:

- Checking the liquid limit device (drop height and condition)
- Weighing tins
- Mixing water with sample
- Making soil cakes, grooving, and completing drops for all three points
- Taking material after 1st trial for Plastic Limit
- Weighing extracted material for all three points

You will have to talk through the remaining steps including:

- Oven drying
- Cooling
- Weighing (you will be given dry weights by the instructor)

You will have to complete the calculations including making a flow curve.

### **Plastic Limit:**

You will have to complete the test steps including:

- Removing proper amount of sample for test
- Rolling the soil mass down the proper size for determining plastic limit
- Determining when the sample is at the plastic limit
- Repeating the steps for the remainder of the sample
- Weighing the material

You will have to talk through the final steps including:

- Oven drying
- Cooling
- Weighing

You will have to complete the calculations for Liquid and Plastic Limits and for Plasticity Index.

### **Unit Weight - AASHTO T 19:**

You will be given a unit weight sample prepared for rodding to the point at which unit weight trials will begin. You will have to talk through the preparation steps including:

- Measure selection
- Procedure selection
- Sample size
- Oven drying
- Calibrating the unit weight measure

You will have to complete the steps from this point including:

- Mixing the material
- Filling, rodding, and striking the aggregate for one trial
- Weighing the material (you will be given the second trial weights)

You will have to complete the calculations for the unit weight.  
You will have to explain the jiggling and shoveling procedures.  
You will have to explain what constitutes valid results.

**Percent Crushed Particles – MP 703.00.21:**

You will be given a sample prepared to the point that the particles can be separated. You will have to talk through the preparation steps including:

- Test portion size determination
- Splitting
- Sieving
- Oven drying

You will have to complete the test steps including:

- Definitions of face fracture particles.
- Identification and separation of into different face fracture groups.
- Weighing each fraction (you will be given weights for the second technician)
- Determination of valid results.

You will have to complete the calculations for the percent crushed particles.

## **MANUAL INSTRUCTIONS**

This booklet has been prepared to assist you in learning the basic theory associated with the subjects leading to training as an Aggregate Technician. It is intended that each chapter or section be studied by you prior to the formal class period on that section. In certain instances, you will be required to complete portions during specific sections of the formal class sessions.

Each chapter has been prepared to correspond to the major subjects that will be covered. This material will be supplemented by power point presentations of test procedures, formal lecture and classroom exercises. Together, these components make up the initial phase of the training which you will receive. This phase will prepare you for the written examination, together with practical application. Further application in the field and laboratory will prepare you for the practical examination.





# Chapter 1

## General Information

This chapter contains general information, including definitions and descriptions, of aggregates used in West Virginia and the tests used to control quality. As you study the material, special instructions, in parentheses, will tell you when to turn to another section. To get the most out of the material, you should follow the instructions exactly. Do not try to second-guess by turning to the answers before you have carefully studied the questions. As you come to the special instructions, move to the new section indicated immediately. It would be helpful if you had copies of the AASHTO Specifications and Tests Manuals, and/or the ASTM Manuals, available for reference.

### **DEFINITIONS:**

Aggregates: Aggregates are composed of inert mineral matter, either crushed or uncrushed, which have been properly sized for the use intended. Sizes are divided into two general groups known as coarse aggregate and fine aggregate (sand). In West Virginia, material, which is retained on a No. 4 (4.75 mm) screen, is considered coarse aggregate and material passing the No. 4 (4.75 mm) screen is classified as fine aggregate. Coarse aggregates are further sub-divided into standard sizes in accordance with AASHTO Designation: M 43 (Table 1, page 1-23).

Crushed Stone: Crushed stone is composed of either crushed ledge rock, crushed boulders or crushed gravel and consists of angular fragments of hard durable stone.

Gravel: Gravel consists of hard, durable particles of rock larger than the No. 4 (4.75 mm) sieve and usually deposited by stream or glacial action.

Slag: Slag consists of clean, tough, durable pieces of air-cooled blast-furnace slag, reasonably uniform in density and quality and reasonably free from glassy pieces. Slags other than blast-furnace slag are sometimes used in special applications.

Natural Sand: Natural sand is the fine granular material resulting from the natural disintegration of rock and must consist of clean, hard, durable, uncoated particles. It is normally obtained by dredging riverbeds or quarrying pit deposits and may be properly sized without crushing.

Manufactured Sand: Manufactured sand is similar to natural sand except it has been reduced in particle size by crushing. The parent material may be limestone, slag, sandstone, or gravel.

Uses: Aggregates are used in Portland cement concrete, bituminous concrete, base courses, granular backfills, surface treatments, pipe bedding, and other applications. Different types of aggregates may be used for different specifications.



## THE ROCK CYCLE:

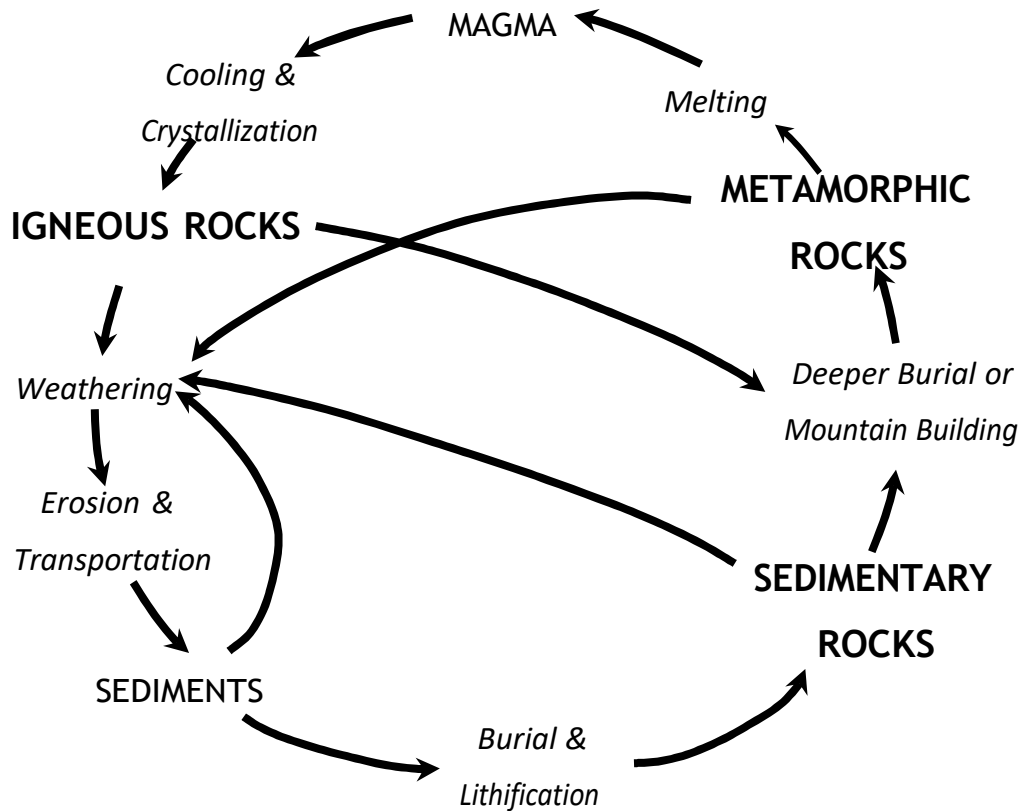

There are three main types of rocks which occur on the earth, igneous, sedimentary, and metamorphic. Due to the dynamic conditions which occur on and within the earth, there is a continuous cycle which the rocks go through from one rock type to another. The atoms and molecules which make up the minerals within each rock remain the same, just their arrangement changes which results in new minerals and changes in rock type.

The common starting place for the rock cycle is with molten rock or magma. When molten rock reaches the earth's surface as lava or near the earth's surface as magma, it cools into rocks of differing composition depending on the composition of the magma and cooling rate. Diabase and granite are examples of rocks which cooled to a solid state slowly from magma of differing compositions. Basalt would be an example of an igneous rock which cooled to a solid state rapidly from lava of a certain composition.

Once these rocks are cooled to a solid state and exposed at the earth's surface by erosion, some of the rocks are physically broken down into smaller particles or chemically dissolved by weathering. They are then transported by water or wind and deposited as sediment, or the dissolved minerals precipitate as sediment. River gravel and natural sand and to some extent soil are examples of sediment. This sediment can be further weathered, transported, and deposited or can be buried and lithified (solidified) into sedimentary rocks. Sandstone and orthoquartzite are examples of sedimentary rocks. Limestone is an example of a sedimentary rock which has been formed by the precipitation of dissolved minerals in water or by the accumulation of calcium carbonate skeletal material or shells of animals living in the water. The skeletons and shells of the animals are often preserved as fossils in the limestone. Sedimentary rocks can be exposed through erosion and be weathered, transported, and deposited again as sediment.

Both igneous and sedimentary rocks can be subjected to metamorphism which is simply chemical and/or physical alteration due to intense heat and/or pressure. This intense heat and pressure is often associated with deep burial, mountain building forces, or molten rock intrusion or volcanism in the surrounding rocks where complete melting does not occur. Metaquartzite, marble, and slate are examples of metamorphic rocks. Metamorphic rocks can be exposed to weathering by erosion and weathered into sedimentary rocks.

The rocks previously described can be subject to melting to form igneous rocks which would start the entire process again. Extremely deep burial, volcanism, or igneous rock intrusion where surrounding rock is incorporated in the magma could result in a change into igneous rock.

## **TYPES OF ROCK AND SOURCES:**

Limestone: Limestone is composed primarily of calcium and magnesium carbonates. It occurs in massive ledges which are quarried and mined in eastern West Virginia, Maryland, Pennsylvania, Ohio, western Virginia, southeastern Indiana, Kentucky, and southern Illinois.

River Gravel: Gravel is a naturally occurring material which is dredged from deposits in the riverbed or quarried from pits where material has been deposited by moving water. The Ohio River Basin in West Virginia and the Scioto River area in Ohio furnish commercial aggregates to West Virginia.

Blast Furnace Slag: Blast Furnace Slag is formed when iron ore or iron pellets, coke, and a flux (either limestone or dolomite) are melted together in a blast furnace. When the metallurgical smelting process is complete, the lime in the flux has been chemically combined with the aluminates and silicates of the ore and coke ash to form a non-metallic product called blast furnace slag. During cooling and hardening from its molten state, BF slag can be cooled in several ways to form any of several types of BF slag products.

Steel Furnace Slag: Steel Furnace Slag is produced in a (BOF) Basic Oxygen Furnace or an (EAF) Electric Arc Furnace. Lime is injected to act a fluxing agent. The lime combines with the silicates, aluminum oxides, magnesium oxides, manganese oxides and ferrites to form steel furnace slag, commonly called steel slag. After cooling from its molten state, all free metallics are removed by processing and it is sized into products.

Slag was once scorned as a useless byproduct, it is now accepted and, often, preferred as a valuable material with many and varied uses. Most slags used in West Virginia are produced by the blast-furnace steel mills of West Virginia, Pennsylvania, and eastern Kentucky. The blast-furnace slags currently in use are characterized by light weight

(Specific Gravity of 2.20 - 2.30) and an extremely porous surface. We are beginning to use metallurgical and basic-oxygen slags however, which are dense, heavy (specific gravity of 3.30 - 3.40) and have smooth surfaces.

Sandstone: Sandstone occurs widely throughout the State in many forms, from very hard quartzites to very soft conglomerates. This non-uniformity limits the durability of sandstone and in most cases, curtails its use in higher type construction. It is used mainly in base and sub-base construction.

Diabase: An intrusive igneous rock that cooled from magma below the earth's surface consisting of both light and dark crystals, medium to coarse grained in size of the minerals labradorite and augite.

Granite: An intrusive igneous rock that cooled from magma below the earth's surface containing the minerals quartz, plagioclase feldspar, orthoclase feldspar, and mica in medium to coarse grained crystals.

Basalt: An igneous rock which cooled from lava at the earth's surface containing black or dark green crystals of the mineral calcium plagioclase and pyroxene in very fine grained crystals, often too small to be seen with the naked eye.

Quartzite: Can be a metaquartzite which consists of mainly the mineral quartz which has been recrystallized by metamorphism or an orthoquartzite which is a sedimentary rock consisting mainly of quartz grains cemented together with silica cement.

## **PROPERTIES AND CHARACTERISTICS:**

The special qualities most commonly noted for road building aggregates are durability, resistance to wear or abrasion, hardness, and freedom from deleterious substances. Occasionally the absorption and specific gravity may become factors worthy of consideration. Aggregate that tends to break up or to chip on the edges because of handling or abrasion is said to be subject to degradation.

### **ABRASION RESISTANCE:**

Abrasion resistance of an aggregate is often used as a general index of aggregate quality. It is essential for aggregate to be used in construction to exhibit properties of abrasion resistance.

### **The Los Angeles Abrasion test is used to measure wear or abrasion resistance.**

The Los Angeles abrasion machine consists of a cylindrical drum charged with a standard weight of aggregate particles and mounted longitudinally on a horizontal shaft. A standard weight of steel balls is also placed in the drum as an abrasive charge and the drum rotated for 500 revolutions after which the material is removed and sieved. The percentage of material passing the No. 12 (1.70 mm) sieve is the percent wear. See AASHTO T 96.

See West Virginia Standard Specifications for Roads and Bridges, Section 700 for most aggregate specifications.

### **DURABILITY:**

Resistance to freezing and thawing is important when aggregates are used in exposed construction.

The freeze-thaw resistance of an aggregate is related to its porosity, absorption, pore structure, and strength of binder. If an aggregate particle absorbs so much water that

sufficient pore space is unavailable to accommodate water expansion that occurs during freezing, it may be fractured and break into smaller pieces. Aggregate fracture can result in fracture of the surrounding concrete which are called “pop outs” if located near an exposed surface.

Aggregates which are to be subjected to severe exposure conditions are often specified to conform to requirements of the soundness test. **The soundness test is an indication of the resistance to weathering of fine and coarse aggregate.** It measures the resistance of aggregate to disintegration by use of a saturated solution of sodium sulfate. The test is conducted by immersing containers of sized fractions of an aggregate sample in the solution. Samples are oven-dried after each immersion. The solution is absorbed by the aggregate and, during oven drying, evaporates to form salt crystals in the internal voids or pores in the aggregate. These crystals expand during formation and create a force that may break up an aggregate which is not durable. After the aggregate sample has completed five cycles of soaking and oven drying, the percent weight loss is determined by sieving. Refer to AASHTO T 104 and West Virginia Standards and Specifications for Roads and Bridges, Section 700.

### **ABSORPTION AND SURFACE MOISTURE:**

Absorption and surface moisture of aggregates may need to be determined (AASHTO Designations: T 84 and T 85), so that the water content can be controlled. The internal structure of an aggregate particle is made up of solid matter and voids that may or may not contain water.

Aggregate moisture conditions are defined as follows:

1. Oven-dry or fully absorbent, with no surface or internal moisture.
2. Air-dry, or dry at the particle surface but containing some interior moisture - thus, somewhat absorbent.

3. Saturated-surface-dry (SSD), an ideal condition in which the aggregate can neither absorb water nor contribute water. In this condition the interior has absorbed all the moisture it can hold, but there is no free moisture on the surface.
4. Damp or wet, the aggregate interior has absorbed all the moisture it can hold and there is an excess of moisture on the particle surface.

Batch masses of material must be adjusted for moisture conditions of the aggregates.

### **SPECIFIC GRAVITY:**

Specific gravity of an aggregate is the ratio of its weight to the weight of an equal volume of water. It is a value used in certain computations for asphalt and concrete mix design and control. It is not a measure of aggregate quality. For normal-weight aggregates, the specific gravity is generally between 2.4 and 2.9, except for slags, which may be either lighter or heavier.

The test methods for determining specific gravity for fine and coarse aggregates are described in AASHTO T 84 and T 85 respectively. In concrete calculations, the specific gravities of saturated surface-dry aggregates are generally used; that is, all the pores in each aggregate particle should be filled with moisture, but there should be no excess moisture on the particle surface.

### **DELETERIOUS MATERIAL:**

It is very important that the aggregate be kept clean and free from foreign substances which might cause problems within a base course, concrete pavement, asphalt pavement, or a structure. For this reason, specifications limit the number of deleterious substances that can be present within the final aggregate product. Thin or elongated pieces tend to decrease the stability of the mixture and tend to fracture. Shale is one of the worst deleterious substances in an aggregate due to its tendency to breakdown and disintegrate rapidly when exposed to weathering. Coal and other light-weight materials

are not desirable. Organic particles decay and breakdown rapidly and some lightweight materials have low freeze/thaw resistance. Friable particles are undesirable because they are non-cemented particles loosely held together which readily break apart under very little pressure. See AASHTO T 112, T 113 and ASTM C 295.

### **UNIT WEIGHT:**

Unit weight is a ratio of weight to volume. Unit weight is not a measure of quality but is useful in converting weights of material to volumes. Lightweight aggregates must not exceed a maximum unit weight for use in concrete mixtures. See AASHTO T 19.

### **SHAPE AND SURFACE TEXTURE:**

Particle shape of either coarse or fine aggregate may be angular, sub-angular, sub-rounded, or rounded.

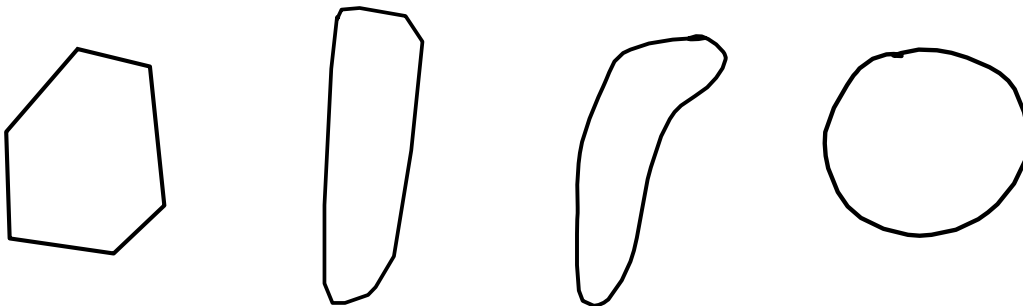

Angular

Sub-Angular

Sub-Rounded

Rounded

Aggregate particles should be chunky and free of excessive amounts of thin and elongated pieces as mentioned on page 1-14. Long, slivery aggregate pieces should be avoided.

Particle shape and surface texture have a definite bearing on the quality of the finished product. For example, in concrete, aggregate pieces with more angularity will require more mix water for a given consistency. Base courses, and asphalt mixtures, composed of angular particles will compact and key together to form a dense, tight product, while elongated and rounded particles will slide and roll without compacting. On the other hand, rounded particles tend to make plastic concrete more workable without a detrimental effect on the hardened concrete.



## **GRADATION:**

**Gradation is the particle size distribution of aggregates determined by using sieves with square openings.** As a well graded aggregate is moved or handled there is a tendency for the particle sizes to separate into layers with the larger pieces at the bottom and the finer pieces at the top. This separation is known as segregation. Limits are usually specified for the percentage of material passing each sieve. There are several reasons for specifying grading limits and maximum aggregate size. Variations in grading, for a given size or class of aggregate, may seriously affect the uniformity of finished work. In a concrete mix very fine sands are uneconomical and very coarse sands produce harsh, unworkable mixes. In general, aggregates that do not have a large deficiency or excess of any size and give a smooth grading curve produce the most satisfactory results.

## **UNIFORM OR WELL-GRADED:**

**Well-graded aggregates usually contain an equal amount of the various sizes.** This produces a dense mixture as each smaller size fills the voids in the next larger size. See Figure 1, a typical Grading Curve of a Well-Graded Aggregate and note the following pertinent features:

1. This is a Standard DOH Form No. MC-6.
2. Percent passing on the Y-axis.
3. Various sieve sizes on the X-axis.
4. Well-graded material gives a smooth curve with a uniform slope when a line is drawn through the plotted points for this gradation. See Figure 2.

Percentages Retained and Percentages Passing on same sieves used for the Grading Curve of a Well-Graded Aggregate and note the following:

1. This shows the percent retained on each sieve for the gradation plotted on Figure 1.
2. Retained percentages must add up to 100%.
3. Relationship between passing and retained.

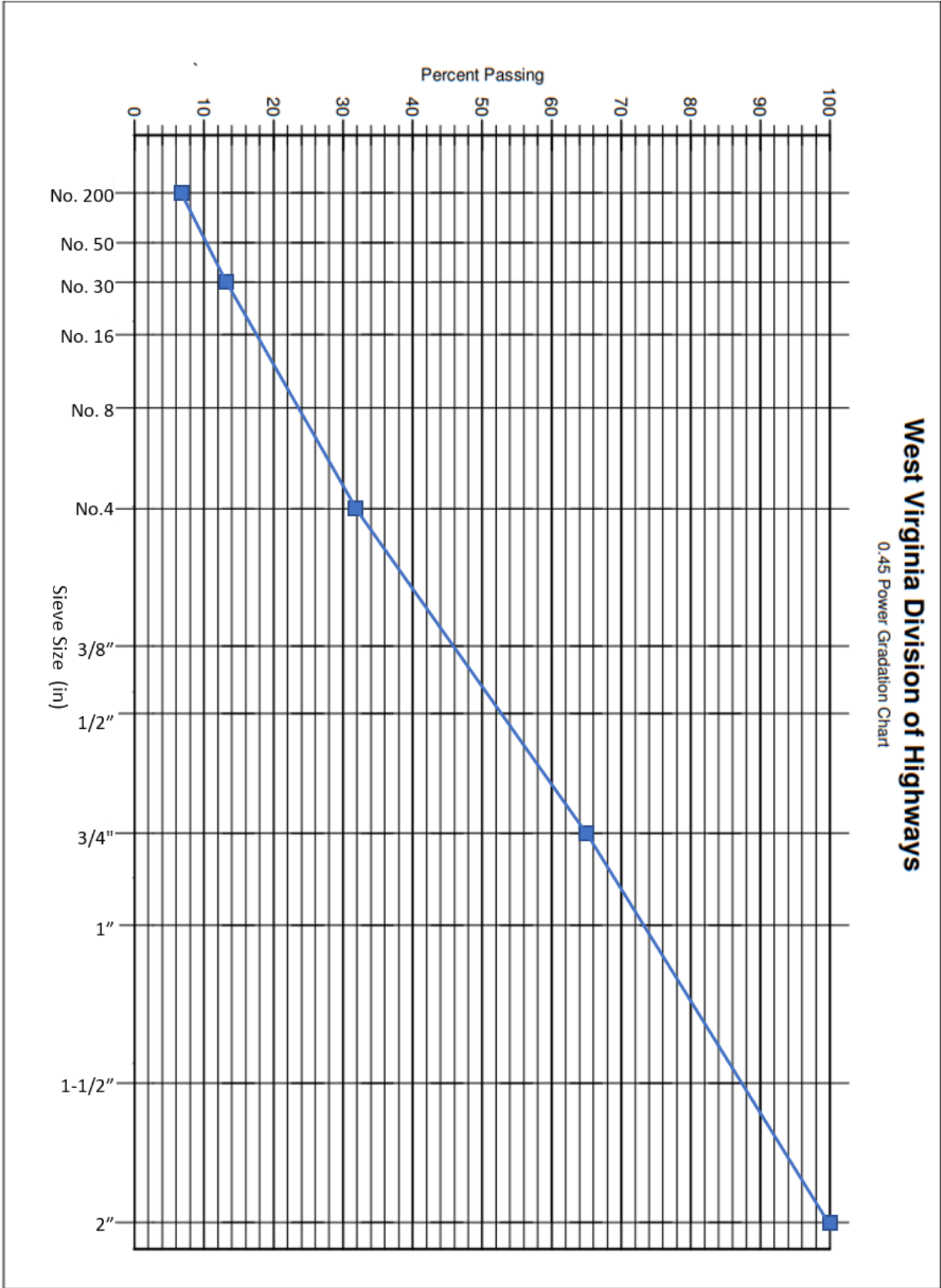

**Figure 2**

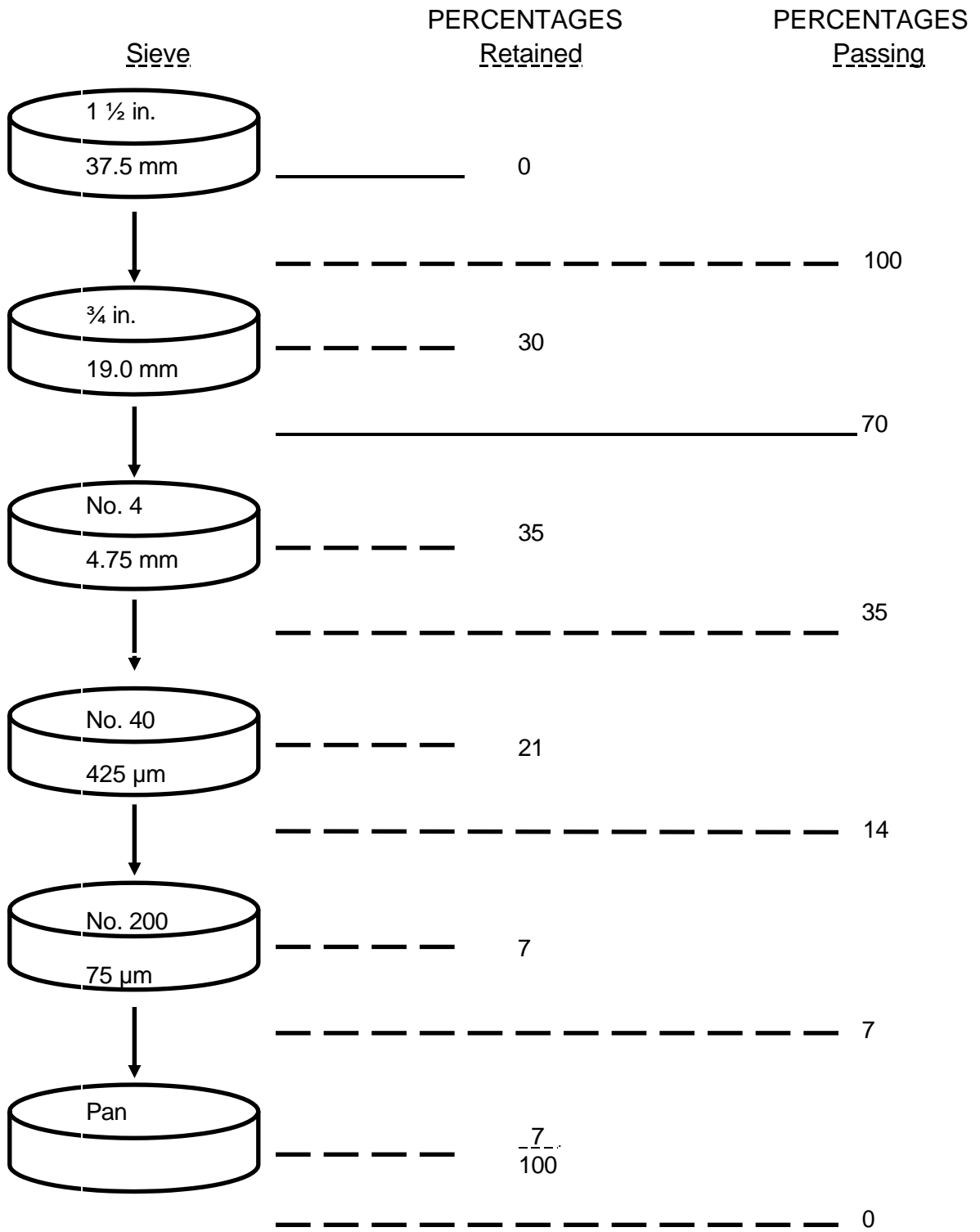

## **POORLY GRADED:**

**Poorly graded aggregates contain too great an amount of particles of nearly the same size.** This produces an open-type mixture with large void spaces. There are not enough of the smaller sizes to fill the voids between the larger sizes. See Figure 3 on Page 1-15 showing the plotted gradation of a Poorly Graded Material and note the following pertinent features:

1. Standard DOH Form MC-6.
2. Percent passing on the Y-axis.
3. Sieve sizes on the X-axis.
4. Poorly graded material, and in this case a predominantly sized material between the 1 in. (25.0 mm) and 1/2 in. (12.5 mm) sieve gives a much steeper curve between these sieves than a uniform graded material curve shown in Figure 1 on Page 1-12. See Figure 4 on page 1-16 of Retained and Passing Percentages on same sieves used for the grading curve.

Note the following:

1. Relationship between passing and retained.
2. Large percent retained on 1/2 in. (12.5 mm) sieve accounts for steep portion on gradation curve in Figure 3 on Page 1-15.

**West Virginia Division of Highways**  
0.45 Power Gradation Chart

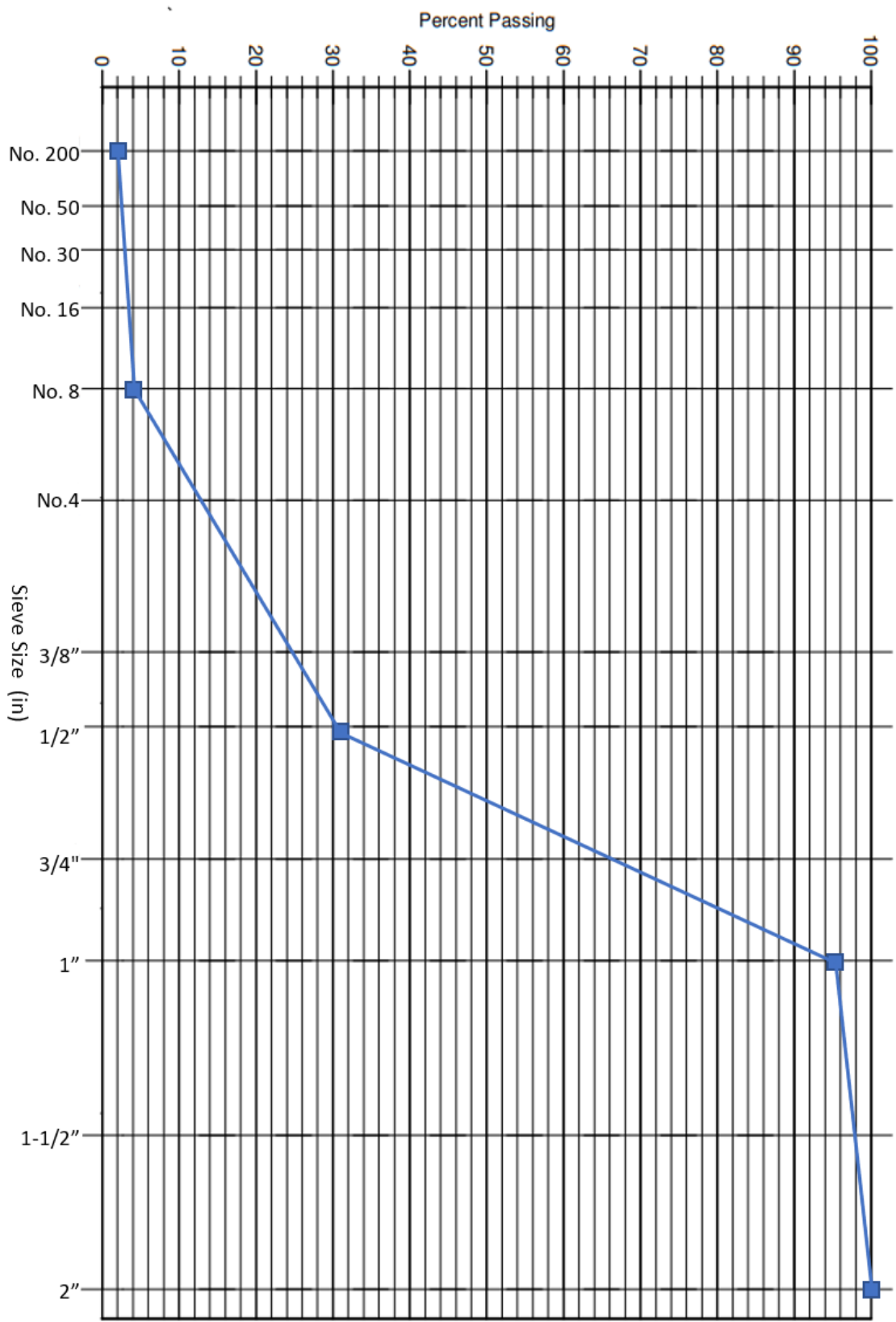
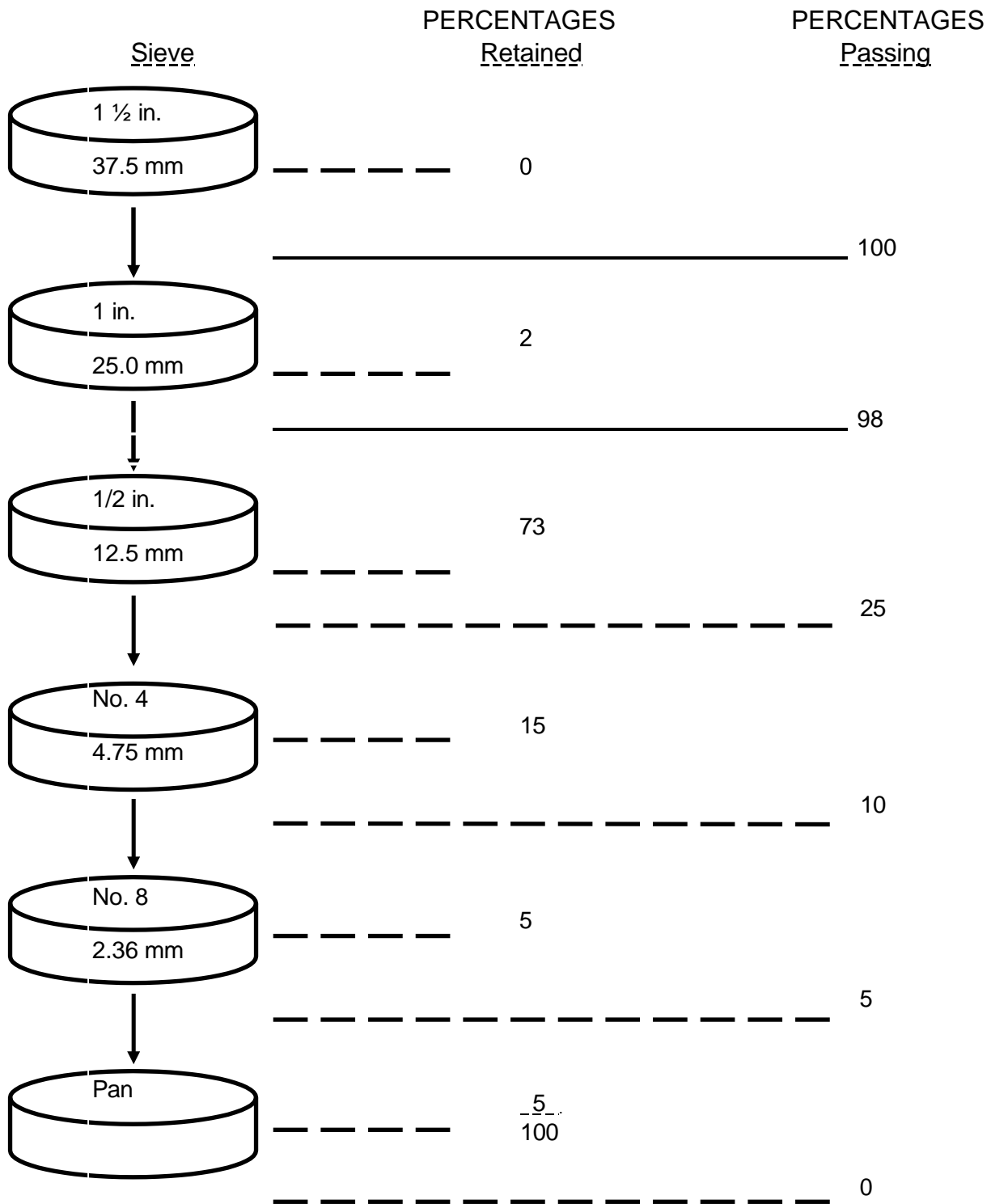

Figure 4



**Coarse-Graded:**

Coarse aggregates normally consist of one of the following materials:

- (1) Crushed Stone, (2) Gravel, (3) Air-Cooled Blast- Furnace Slag.

Coarse aggregates have certain specified gradations. In West Virginia these are the gradings with most of the particles larger than the No. 4 (4.75 mm) sieve. See Table 1 and Table 2 (pages 1-23 and 1-24).

**Fine-Graded:**

Fine aggregate consists of sand or other approved mineral material with similar characteristics, or a combination of these, having hard, durable and strong particles. In West Virginia, fine aggregates are particles that will pass the No. 4 (4.75 mm) sieve. See Table 3 (page 1-25).

**NOMINAL MAXIMUM SIZE:**

Maximum size, top size, largest size, nominal size, and other similar terminology has the same meaning as nominal maximum size and is defined as the largest standard sieve size listed in the applicable specifications upon which any material is **permitted** to be retained. Exception: If the specification tolerances are such that no sieve listed has a range of X% - 100% passing, then the next smallest standard sieve, as listed in Table 1, of MP700.00.06 (page A-45) below which 100% must pass will be considered the nominal maximum size. West Virginia Standard Specifications specify aggregate sizes for each type of construction. The numbered sizes for coarse aggregates are listed in Table 1 of AASHTO M 43 (reproduced as Table 1, Page 1-23 of this manual), both as a size number and nominal size. Note that the nominal maximum size is the first sieve listed in the nominal size column.

The first example below lists the specification sieves and specified percents passing for each of an AASHTO No. 57 aggregate. Note that the nominal maximum size for a No. 57 aggregate is 1 in. (25.0 mm). The second example below lists the specification sieves for a Class 2 aggregate and the specified percents passing (see Table 2 on page 1-24 for Class specs from Section 704.6.2). Note that the nominal maximum size for the Class 2 aggregate is 3/4 in. (19.0 mm).

**Nominal Maximum Size** is defined as follows:

**The largest standard sieve size listed in the applicable specification upon which any material is permitted to be retained when the aggregate is graded.**

EXAMPLE

(1) Example: AASHTO No. 57 Limestone

1 1/2 in.	1 in.	1/2 in.	No. 4	No. 8
100%	95-100%	25-60%	0-10%	0-5%

...in this case 1 in. (25.0 mm) would be the nominal maximum size.

(2) Example: WV Class 2 Base course

1 1/2 in.	3/4 in.	No. 4	No. 40	No. 200
100%	80-100%	35-75%	10-30%	0-10%

...in this case 3/4 in. (19.0 mm) would be the nominal maximum size.

**Exceptions to the above definition:**

Where the specifications range is such that no sieve has a range of X%-100% passing, then the next smallest standard sieve, as listed in Table 1 of MP700.00.06 and below that sieve which 100% must pass will be considered the nominal maximum size.



The nominal maximum sizes normally encountered in highway construction are those listed in MP700.00.06 Tables I and II. **When checking for nominal maximum size, be sure to note whether the specification skips the nominal maximum size sieve.** In example 3 below, Class 1 Base Course (Table 704.6.2, Table 2 on page 1-24) specifies 100 percent passing the 1 1/2 in. (37.5 mm) sieve and 50-90 percent passing the 3/4 in. (19.0 mm) sieve, etc. Notice in Table I from MP700.00.06, the next smaller sieve listed below the 1 1/2 in. (37.5 mm) sieve is the 1 in. (25.0 mm) sieve. When graded, a Class 1 Base Course may retain some material on the 1 in. (25.0 mm) sieve, even though it is not required by the specification. A Class 1 Base Course has a nominal maximum size of 1 in. (25.0 mm) not 3/4 in. (19.0 mm). The same situation can be seen in example 4 below.

(3) Example: Class 1 Base Course

1 1/2 in.	3/4 in.	No. 4	No. 40	No. 200
100%	50-90%	20-50%	5-20%	0-7%

...in this case 1 in. (25.0 mm) would be considered the nominal maximum size.

(4) Example: Class 5 Base course

2 in.	No. 4	No. 200
100%	30-90	0-25

...in this case 1 1/2 in. (37.5 mm) would be considered the nominal maximum size.

See Table 1, Table 2, and Table 3 for West Virginia Gradation Specifications for Coarse and Fine Aggregates.

Note that in Table 1 the “Nominal Size Openings” lists the sieves included that most of the specified particle sizes.

### **FINENESS MODULUS:**

Fineness modulus of either fine or coarse aggregate is defined as the sum of the cumulative percentages retained on the standard sieves divided by 100. It is an index to the fineness of an aggregate -- the higher the fineness modulus, the coarser the aggregate.

### **ATTERBERG LIMITS:**

Some important tests commonly conducted in conjunction with some gradation testing are the Atterberg Limits (consistency tests). The two limit tests conducted are the Liquid and Plastic Limits and also determined is the Plasticity Index. These tests are influenced by the amount of clay particles because of the cohesive properties of clay, which directly influence the drainage characteristics of the aggregate. When aggregates contain high amounts of clay particles, water passages between larger particles can become clogged. When aggregate is used as a shoulder material or as a base course, a lack of drainage would be considered detrimental.

### **ROUNDING PROCEDURES:**

Rounding procedures have been adopted from standard math rounding procedures and may be described as follows:

If the number following the last number to be retained is **less than 5, the last number to be retained is left unchanged** and the number(s) following the last number to be retained is/are discarded.

If the number following the last number to be retained is **5 or larger, increase the last number to be retained by 1** and discard the number(s) following the last number to be retained.

## **TERMINOLOGY FOR BALANCES AND SCALES:**

Balances shall conform to the requirements of AASHTO M 231 for the class of general purpose balance required for the principal sample weight of the sample being tested. The following is a list of terminology that may be useful when referring to scales and balances:

**Principal Sample Weight:** - the weight of the entire sample being tested, or the greatest weighing made in conducting the test.

**Readability:** - The smallest fraction of a division at which the index scale can be read with ease either by estimation or by use of a vernier on a direct reading balance.

**Sensitivity:** - Weight required to produce a discernible movement in the indicating system of the balance or scale.

**Accuracy:** - Maximum permissible deviation of indications of a balance or scale from the true value within applicable tolerances.

**Capacity:** – the maximum load recommended by the manufacturer.

## **SUMMARY: (Aggregates)**

For most purposes, aggregates must conform to certain requirements and should consist of clean, hard, strong, and durable particles free of chemicals, coatings of clay, or other fine materials that may affect construction.

Weak, friable, or laminated aggregate particles are undesirable. Aggregates containing natural shale or shale-like particles, soft and porous particles, and certain types of chert should be especially avoided since they have poor resistance to weathering. Visual inspection will often disclose weaknesses in coarse aggregates.

Normal-weight aggregate for most purposes should meet the requirements of the Standard Specifications. These specifications limit the permissible amounts of deleterious substances and cover requirements for gradation, abrasion, and soundness.

Table 4 (page 1-26) contains a summary of important characteristics of aggregate and applicable test procedure references.

**(Find the answers to the 10 questions on Page 1-27 and mark or highlight the answers for easy retrieval during the written part of the Aggregate Technician Exam.)**

TABLE 1

TABLE 703.4 STANDARD SIZES OF COARSE AGGREGATES AASHTO M 43																	
Size Number	Nominal Size Square Openings	Amounts finer than each laboratory Sieve [square openings], percentage by weight															
		100 mm 4 in.	90 mm 3-1/2 in.	75 mm 3 in.	63 mm 2-1/2 in.	50 mm 2 in.	37.5 mm 1-1/2 in.	25.0 mm 1 in.	19.0 mm 3/4 in.	12.5 mm 1/2 in.	9.5 mm 3/8 in.	4.75 mm No. 4	2.36 mm No. 8	1.18 mm No. 16	300 μm No. 50	150 μm No. 100	
1	90 mm — 37.5 mm 3-1/2 in. — 1-1/2 in.	100	90-100		25-60		0-15		0-5								
2	63 mm — 37.5 mm 2-1/2 in. — 1-1/2 in.			100	90-100		0-15		0-5								
24	63 mm — 19 mm 2-1/2 in. — 3/4 in.			100	90-100		25-60		0-10	0-5							
3	50 mm — 25.0 mm 2 in. — 1 in.				100	90-100	35-70	0-15		0-5							
357	50 mm — 4.75 mm 2 in. — No. 4				100	95-100		35-70	10-30						0-5		
4	37.5 mm — 19.0 mm 1-1/2 in.				100	90-100	20-55	0-15		0-5							
467	37.5 mm — 4.75 mm 1-1/2 in. — No. 4				100	95-100	35-70	10-30		0-5							
5	25.0 mm — 12.5 mm 1 in. — 1/2 in.				100	90-100	20-55	0-10	0-5								
56	25.0 mm — 9.5 mm 1 in. — 3/8 in.				100	90-100	40-80	10-40	0-15	0-5							
57	25.0 mm — 4.75 mm 1 in. —				100	95-100	25-60		0-10	0-5							
6	19.0 mm — 9.5 mm 3/4 in. — 3/8 in.				100	90-100	20-55	0-15	0-5								
67	19.0 mm — 4.75 mm 3/4 in. — No. 4				100	90-100	20-55	0-10	0-5								
68	19.0 mm — 2.36 mm 3/4 in. — No. 8				100	90-100	30-65	5-25	0-10	0-5							
7	12.5 mm — 4.75 mm 1/2 in. — No. 4				100	90-100	40-70	0-15	0-5								
78	12.5 mm — 2.36 mm 1/2 in. — No. 8			100	90-100		40-75	5-25	0-10	0-5							
8	9.5 mm — 2.36 mm 3/8 in. — No. 8			100	85-100		10-30	0-10	0-5								
89	9.5 mm — 1.18 mm 3/8 in. — No. 16			100	90-100		20-55	5-30	0-10	0-5							
9	4.75 mm — 1.18 mm No. 4 — No. 16			100	85-100		10-40	0-10	0-5								
10	4.75 mm — 0 mm No. 4 — 0			100	85-100												10-30

**TABLE 2**

**TABLE 704.6.2A – GRADATION REQUIREMENTS**

Gradation Amounts Finer Than Each Laboratory Sieve (Square Openings), % By Weight											
Aggr. Class	8" (200)	2½" (63)	2" (50)	1½" (37.5)	1" (25)	¾" (19)	#4 (4.75)	#40 (425 µm)	#100 (150 µm)	#200 (75 µm)	
1				100		50-90	20-50	5-20		0-7.0	
2				100		80-100	35-75	10-30		0-10.0	
3				100		50-90	20-50	5-20		4.0-12.0	
4				100		50-95	20-60	5-35			
5			100				30-90			0-25.0	
6				100		50-100	25-70	10-45	3-28		
7	90-100		0-5	with intermediate sizes between 6" (150 mm) and 4" (100 mm) represented							
8				100		80-100	35-75	10-40		4.0-14.0	
9		100		80-95		50-70	20-40			0-8.0	
10 *					100	70-100	30-75	8-40		4.0-20.0	

\* Crusher Run Material Only

**TABLE 704.6.2B - QUALITY REQUIREMENTS**

Aggr. Class	Los Angeles Abrasion, Percent, Max.	Sodium Sulfate Soundness, Percent Max.	Liquid Limit Max.	Plasticity Index, Max.	Deleterious Material Percent Max.
1	50	12	25	6	5
2	50	12	25	6	5
3	50	12	25	6	5
4	<b>Note 1</b>		25	6	5
5			25	6	5
6			25	6	5
7		30			10 (by visual observation)
8	50	12	25	6	5
9	50	12	25	6	5
10	50	12	25	6	5

**Note 1:** The Los Angeles Abrasion value of aggregate comprising the base course shall be treated in the manner hereinafter set forth to determine the specification requirement for the item:

<b>STABILIZATION REQUIREMENTS</b>		
<b>Los Angeles Abrasion Value Assigned to the Base Course Aggregate</b>	LA ≤ 50	None
	50 < LA ≤ 65	Top 4 inches (100 mm)
	65 < LA ≤ 80	Top 6 inches (150 mm)
	80 < LA	Top 8 inches (200 mm)

**TABLE 3**

**FINE AGGREGATE ALTERNATE GRADING**

Fine aggregate shall be well graded from coarse to fine, and when tested by means of laboratory sieves shall conform to the following requirements:

Passing 3/8 in. (9.5 mm) sieve	100% by weight
Passing No. 4 (4.75 mm) sieve	95-100% by weight
Passing No. 16 (1.18 mm) sieve	45-80% by weight
Passing No. 50 (300 $\mu$ m) sieve	10-30% by weight
Passing No. 100 (150 $\mu$ m) sieve	2-10% by weight

SOURCE: Standard Specifications for Roads and Bridges, Section 702.6.

**TABLE 4****CHARACTERISTICS OF AGGREGATES**

<b><u>Characteristic</u></b>	<b><u>Significance or Importance</u></b>	<b><u>Test Designation</u></b>
Resistance to abrasion	Index of aggregate quality. Warehouse floors, loading platforms, pavements.	AASHTO T 96 (Similar to ASTM C131 or C535)
Resistance to freezing and thawing	Structures subjected to weathering.	AASHTO T 104 (Similar to ASTM C88)
Compressive strength	Strong concrete	AASHTO T 71 (Similar to ASTM C87 for Fine aggregate)
Particle shape and surface texture	Workability of fresh Concrete. Compaction of base courses.	None
Grading	Workability of fresh Concrete. Economy.	AASHTO T 11 and T 27
Unit Weight	Classification	AASHTO T 19
Bulk specific gravity	Mix design calculations. Classification.	AASHTO T 84 (Fine aggregate) AASHTO T 85 (Coarse aggregate)
Absorption and surface moisture	Control of quantities used.	AASHTO T 84 or T 85, T 142 or T 217, and ASTM C70



## **CHAPTER 1 STUDY QUESTIONS**

1. What is the sieve number dividing the coarse and fine aggregates?
2. What is an aggregate?
3. What would a low percentage of material passing the No. 12 sieve mean in terms of abrasion resistance?
4. What aggregate property is a measure of the resistance of that aggregate to disintegration caused by weathering?
5. Which aggregate properties are not a measure of aggregate quality?
6. What are the five tests for Deleterious Materials?
7. What is the definition of a Gradation of an aggregate?
8. What is Nominal Maximum Size? What are the exceptions?
9. What is Saturated-Surface-Dry?
10. What is the Principal Sample Weight?

***(Do not forget to highlight the answers in the chapter for future reference.)***



## **CHAPTER 2** **SAMPLING METHODS AND EQUIPMENT**

### **INTRODUCTION:**

This chapter discusses the different sampling methods and equipment required. A copy of MP700.00.06 (pages A-39 to A-48) and excerpts from the Construction Manual (pages A-71 to A-73) contain important needed information and are in the appendices.

Obtaining a representative sample is a critical phase of the aggregate technician's duties. At this point, the money and time which will be expended on the remaining activities of testing and evaluating may be lost or rendered useless by improper sampling technique. If the sample taken is not representative of the total material, it is *impossible* to end up with a test result that is valid. At the completion of this phase of instruction, you should know how to obtain a proper sample. Without this knowledge, it is useless to proceed further into the areas of testing procedure.

### **SAMPLING PROCEDURES:**

Standard procedures that describe the best ways of sampling have been developed through experience. Since the procedure used in taking a sample may have an important effect on the tests results, all personnel involved in sampling are expected to follow the prescribed procedures. The recognized procedures are set forth by MP700.00.06 and will be referenced heavily throughout the remainder of the discussion. Methods of test result evaluation will be discussed later, and all of the evaluation theory is dependent upon MP700.00.06 being followed precisely.

### **THE IMPORTANCE OF RANDOMIZATION:**

Samples must be taken without bias. The place at which any sample is to be taken must not be chosen because of any reason or notion. If a sample is taken at a certain point because the material at that point looks good, bad, or even average, the sample will be

biased. Each sample should be taken at a random location point which depends entirely on chance. If a stone is tossed into the air blindly, and a sample is taken at the exact point at which the stone lands, the location is chosen without bias, and the sample will be a random sample.

When samples are to be taken from an area without bias, it is best to use a table of random numbers to determine where the samples are to be taken. This method is the fairest one and relieves the sampler of the responsibility of deciding where a random sample is most likely to be found. A table of typical pairs of random numbers is given in Attachment 1 of MP700.00.06. Observe the arrangement of the numbers in Attachment I (page A-48). Note that all the numbers are decimals; this allows any material, measured by length, area, weight, volume, time, etc., to be multiplied by the random number to locate a specific point.

Randomly select a number from the table by placing the table on a flat surface and carelessly toss a pencil on the numbers. The pencil point will indicate a random number, in this example it is the first number in the third column, 0.886. To locate a random point on the centerline of a section of pavement 200 ft. long, multiply 200 ft. by 0.886 and measure off 177 ft. along the centerline to establish point.

To establish a point for offset, in the lane adjacent to the centerline, multiply the lane width by the companion number to 0.886, which is 0.125. If the lane is 20 ft. wide, the random point is located by measuring along the centerline 177 ft. and then offsetting into the lane 3 ft.

#### **MP700.00.06. AGGREGATE SAMPLING PROCEDURES:**

Carefully read Sections I and 3 of MP700.00.06 (page A-39) and excerpts from the Construction Manual. *Study the sampling and testing frequencies for aggregates in Figure 700A, (page A-71 thru A-73 in Appendix). Note that quality checks (samples to be tested for Los Angeles abrasion, soundness, etc.) may be sampled from any place*

*between production and use.* The most common method used to **sample for quality** is stockpile sampling. Read Section 6.1.4 of MP700.00.06. This is allowable because the properties relating to quality are not subject to change by handling. This is not true of samples for gradation, since the material is subject to segregation each time it is handled. Gradation samples should be taken at the last practical point before incorporation into the work. Go back to MP700.00.06 and study Section 3.

In Section 4, pay special attention to the diagrams and note their relationship to each other. A lot of material is divided into sublots, (MP - Page 2, page A-40). A sampling unit is randomly selected within each subplot. Five increments are randomly located in each sampling unit. All material within each increment is physically removed from the sampling unit and the material removed from all five increments is mixed back together to make a field sample. When testing begins, the quantity of material needed for each test may be split from the field sample. Keep these relationships firmly in mind as we continue to study MP700.00.06, Section 4.

Section 5 means that the Contractor or producer is responsible for providing any special equipment, including any modifications necessary to the plant itself, needed to allow the samples to be taken in accordance with MP700.00.06.

Section 6 defines the acceptable procedures to be followed in securing a sample. Go back to Section 4 and review the definitions to be sure you have complete understanding of each term. No matter where the sample is taken from, the steps to follow are similar to: (a) what is the size (quantity) of the SUBLOT represented by the sample? (b) Where is the SAMPLING UNIT located in the subplot? (c) Where are the five INCREMENTS to be removed located within the sampling unit? (d) Were the increments all combined to form the FIELD SAMPLE? (e) Was the TEST PORTION used for a specific test accurately split out of the field sample?

Please note that the examples given for randomly locating the sampling units are not the only way it can be done. You should consult with the Materials Engineer/Supervisor to set up the best plan for the material you are sampling.

Section 6.1.3 lists sampling from a flowing stream of aggregate as a place where a sample may be obtained. Due to safety hazards this method is seldom used. Read this section to become familiar with the basics of the procedure in the event that a sample must be taken in this situation.

**ROADWAY SAMPLING:**

In the beginning of the chapter, a section of pavement 200 ft. long by 20 ft. wide was used as an example. This section of pavement is the subplot and if a base course sample is to be taken from it, what is the next step? Locate the sampling unit within the subplot by calculating the random point, which was located 177 ft. along the centerline and offset 3 ft.

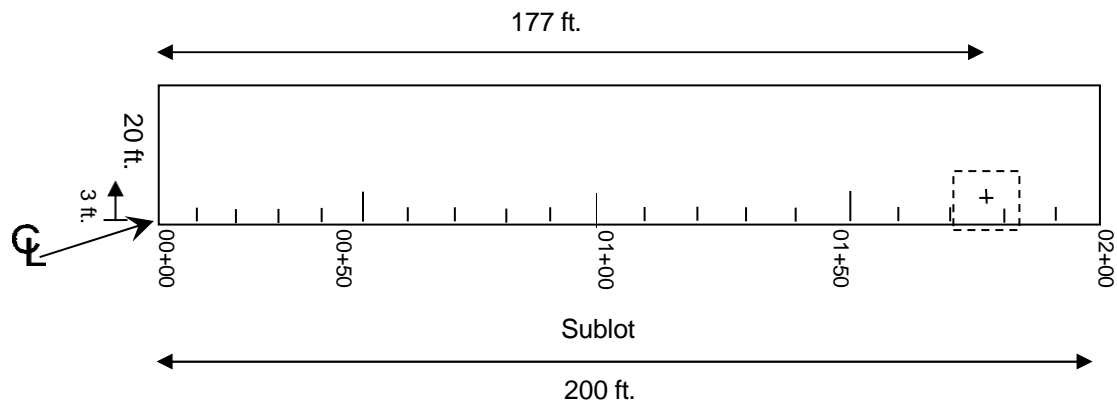

This random point is used to locate the sampling unit. Section 6.1.1 of MP700.00.06 states the sampling unit should have an area with dimensions of 12 ft. by 12 ft. Fit the 12 ft. by 12 ft. sampling unit to the random point. It will look like this:

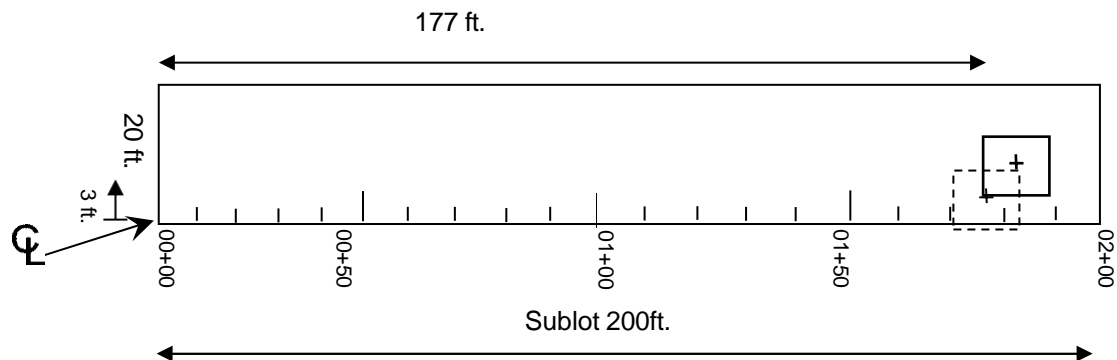

After locating a sampling unit, locate five increments in the sampling unit. Refer to the random numbers in Attachment 1 (page A-48). It is noted that 0.886 and its companion 0.125 were the numbers started with. To locate the five increments, take the next five pairs of random numbers and multiply each by the 12 ft. dimensions.

<u>Length</u>	<u>Offset</u>
0.242 x 12 ft. = 3 ft.	0.316 x 12 ft. = 4 ft.
0.835 x 12 ft. = 10 ft.	0.636 x 12 ft. = 8 ft.
0.139 x 12 ft. = 2 ft.	0.002 x 12 ft. = 0 ft.
*0.215 x 12 ft. = 3 ft.	0.358 x 12 ft. = 4 ft.
0.623 x 12 ft. = 7 ft.	0.855 x 12 ft. = 10 ft.
0.751 x 12 ft. = 9 ft.	0.308 x 12 ft. = 4 ft.

*\*This gives us a duplicate point, so we must use an additional set of random numbers.*

Sampling Unit (Not to Scale)  
12 ft. by 12 ft.

Applying these dimensions, the location of the increments in the sampling unit would look like this:

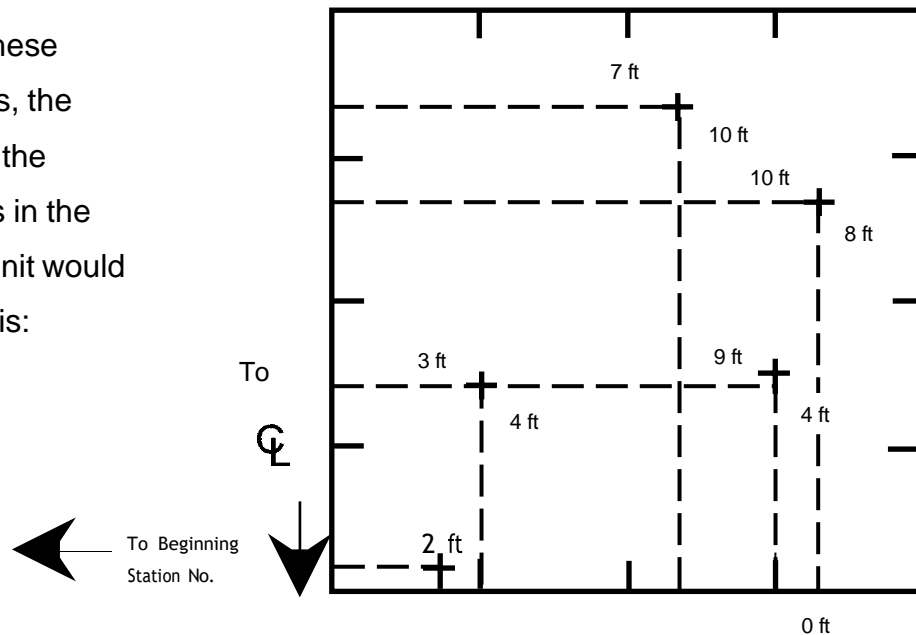

In sampling from the roadway, it is almost imperative that to use a 1 ft. x 1 ft. metal box about 8 to 10 in. high. This will allow the removal of the material for an increment without having the sides ravel into the hole and cause a segregation error. To obtain the sample, center the metal box over the increment locations and remove all the material inside down to the layer below. These five increments may then be combined to form the field sample. (See Figure 2, Page 2-21)

### **SHOULDER SAMPLING:**

Aggregate sampling from shoulder material introduces different situations causing some differences from roadway sampling. Ideally the same procedure of increment location and template sampling as that in roadway sampling should be used. Often this cannot be done due to the dimensions of the template box exceeding the width of the shoulder being placed. The specifications for gradations are for **in place material** prior to compaction. This means we must take the sample either in place or at the last practical place prior to placement. This can be accomplished by two methods depending on the situation at the sampling location.

#### **1). Spreader Box Sampling-**

Sampling from the spreader box is the preferred method. The spreader box is the piece of equipment into which aggregate from the truck is dumped. At the same time the spreader box places the material in a set width to grade adjacent to the pavement. Spreader box sampling is accomplished by:

- a. Allowing a portion of a truckload to be introduced into the spreader box and placed.
- b. Having the placement stopped and the truck pull away from the box.
- c. Taking the sample by obtaining several randomly located increments from the box.
- d. Having placement resume.



## 2). Mini-Stockpile Sampling:

Mini-stockpile sampling is conducted similarly to spreader box sampling with the exception that it is done from a mini-stockpile. These stockpiles can be created by either the spreader box, if it has the capability, or by having each truck pull away from the spreader box and dumping a small stockpile.

## CONVEYOR BELT SAMPLING:

Establishing sampling units and increment locations in conveyors or bin discharge is done in the same manner, except only one column is needed in the random numbers since we are usually working with a single dimension rather than an area. Suppose the same set of random numbers used in the above example is used to sample sand from a conveyor belt 50 ft. long. The work hours are from 8:00 AM until 12:00 PM.

Again, the first step is to locate a sampling unit. Notice the conveyor belt will be operating for 4 hours, or 240 minutes. Multiplying the random number, 0.886 by 240 minutes equals 213 minutes, or 3 hours and 33 minutes. Take the sample at 11:33. Increments would be located along the belt as follows:

$$0.242 \times 50 \text{ ft.} = 12 \text{ ft.}$$

$$0.835 \times 50 \text{ ft.} = 42 \text{ ft.}$$

$$0.139 \times 50 \text{ ft.} = 7 \text{ ft.}$$

$$0.215 \times 50 \text{ ft.} = 11 \text{ ft.}$$

$$0.623 \times 50 \text{ ft.} = 31 \text{ ft.}$$

To obtain the sample, stop the belt at 11:33, insert the templates at 7 ft., 11 ft., 12 ft., 31 ft., and 42 ft. along the belt, remove all material between the templates, and combine it into the field sample.

In belt sampling, the width of the templates should be spaced just far enough apart to yield an increment of the correct weight, or approximately one-fifth the weight of the field sample. If solid templates are used, this means a set is needed for each aggregate size sampled. However, it is easy to construct the templates with sliding cross-members which allows a single set to be adjusted for any size material.

**STOCKPILE SAMPLING:**

Stockpile sampling for **gradation** is done only as a **last** resort. It is very important to take great effort to obtain a random sample from the stockpile. Various methods are used to construct stockpiles including conveyor belts and haul trucks. Segregation in stockpiles will generally cause the larger particles to fall to the bottom and concentrate there while finer particles will not fall as far and remain in higher concentration near the top (Figure 1). This will cause the intended original grading of the aggregate to be different than that in various levels of the stockpile. Two samples, one taken from the bottom of the stockpile and one from the top, could have very different gradations

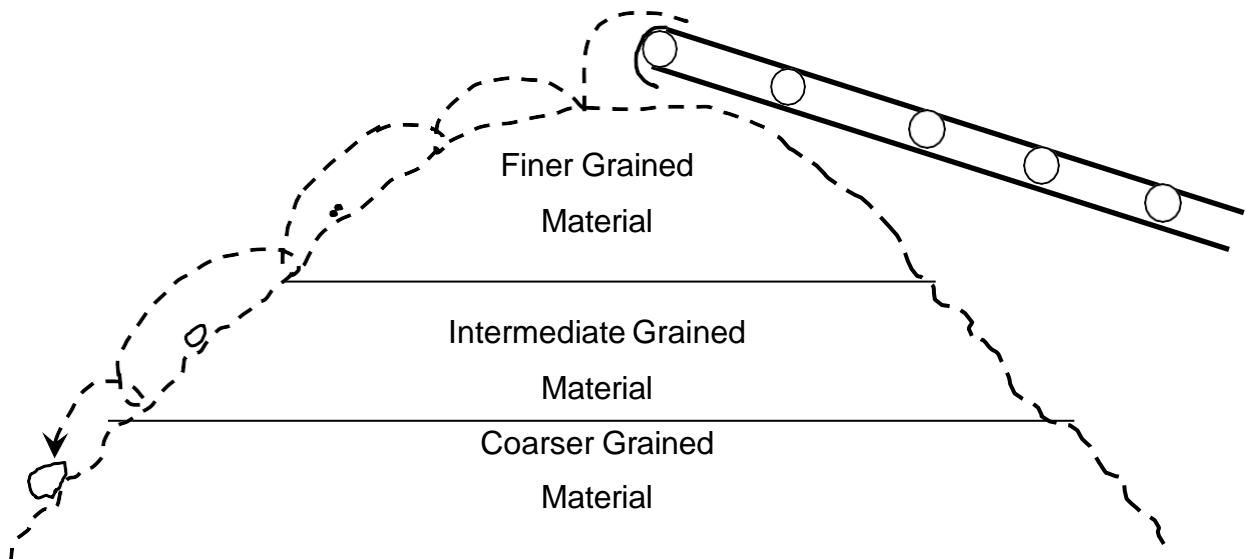

Figure 1: Coarser particles have more energy than fine particles when dropped off the conveyor belt and tend to roll farther down the pile.

yet have been produced with the same gradation. To obtain a truly representative sample of stockpiled material, all levels of the stockpile should be included in a field sample (Figure 2). Stockpile construction should be such that these effects are limited or some means of mixing should be performed prior to shipment and use or placement.

Material quality can also be affected by stockpile construction methods. Quality of production material can often vary daily depending on the type of material. Different methods of stockpile construction will result in material being placed in the various parts of the stockpile from different times of production. Segregation can also result in areas of differing quality within the same stockpile if particles of various size exhibit different quality characteristics. Due to the particle size differences and variations in quality in different areas of the stockpile, a representative sample must have portions or increments taken randomly throughout the stockpile. Samples should not be taken from one location or at different locations around only the base of the stockpile. When sampling from a stockpile, it is advisable to get a piece of power equipment to create a mini stockpile composed of material from different locations and levels of the stockpile mixed together. Another acceptable method is to sample diagonally around the stockpile from top to bottom (Figure 2).

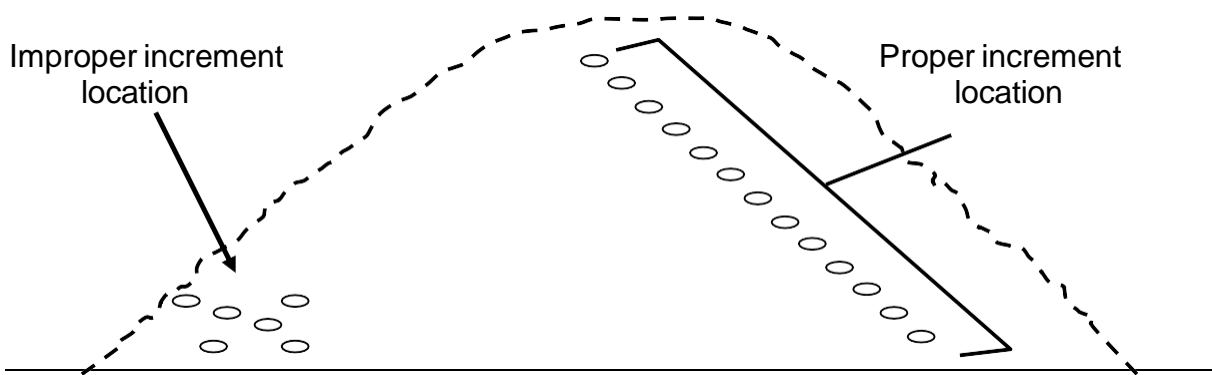

Figure 2: When obtaining quality or gradation samples, sampling may be done diagonally from top to bottom around the stockpile. Portions of the field sample should be taken around the stockpile in a pattern similar to that shown above.

If it becomes *necessary* to obtain a sample from a stockpile, consult the Materials Engineer/Supervisor to help you devise an adequate sampling plan.

Reread Section 6 of MP 700.00.06 to be sure you thoroughly understand it, and then go to Section 7. The main point to remember is that in no case should the weight of a field sample or gradation test portion be less than those listed.

Now study Section 8 of the MP.

Aggregate samples are of two general types:

- (1) those taken for Central Laboratory tests.
- (2) those taken for field tests.

Samples taken for testing in the Central Laboratory should be placed in the standard sacks furnished by the Department. If the sample contains an appreciable quantity of fine material, it may be desirable to use a polyethylene liner in the sacks to prevent loss of the fines. If the aggregate is hot, it should be allowed to cool prior to placing it in a polyethylene lined sack. Each sack of aggregate should be securely sealed with a tie to prevent loss of material in transit. Appropriate identification tags and Form T100 must accompany each sample. Proper identification is very important so that test results can be correlated with specific lots. The name of the source, field sample number and date sampled should be written on the outside of the bag.

Samples taken for testing in the field may be placed in any suitable clean container of appropriate size. The container should be large and secure enough to prevent loss of material in transferring the sample to the testing location.

Figures 1, 2, and 3 (pages 2-20, 2-21, and 2-22) further describe the methods you have just studied. If you have any questions concerning the content of MP700.00.06, consult the instructor for clarification.

## **PLANNING THE SAMPLING PROGRAM:**

Review what has been studied up until now and make a check list of points need to check before starting to sample, and also what should be done after taking the sample.

Sampling: Before sampling begins, ask these questions:

1. Is the plan for getting the sample complete?
2. Has the approved method of taking the samples been checked, and increment locations worked out?
3. Is the weight of the sample required known?
4. Are the proper tools available?
5. Are clean containers at hand for the sample?

Records: After the sample has been obtained, ask the following questions:

1. Does the sample really represent the material?
2. Should the sample be divided and part of it retained?
3. Is the sample completely identified?
4. Does the record show the nature of the material, its source, intended use, and exactly when, where, and how the sample was taken?

It should be clear at this point what sampling is about. It's not always easy to get an adequate sample, but it's very important to use as much care as possible. Always remember, if the sample is not representative, the test results aren't worth the paper they're written on.

**Exercises:**

Complete the following questions:

1. The quantity of material represented by an individual field sample is known as:
  - (a) A sampling unit
  - (b) A subplot
  - (c) An increment
  
2. In sampling from the roadway, the sampling unit should contain approximately:
  - (a) 144 ft.<sup>2</sup> (16 m<sup>2</sup>)
  - (b) 12 ft.<sup>2</sup> (4 m<sup>2</sup>)
  - (c) 5 minutes production
  
3. When sampling from the roadway or from a conveyor belt, a field sample should be made up of:
  - (a) 12 increments
  - (b) 1 increment
  - (c) 5 increments

4. Sample a base course material placed 30 ft. wide from Station 10+50 to 25+00. Working from the right side of the lane and starting with the first random number (0.355) in the next to last column of Table 1. Locate the sampling unit and the required increment positions.

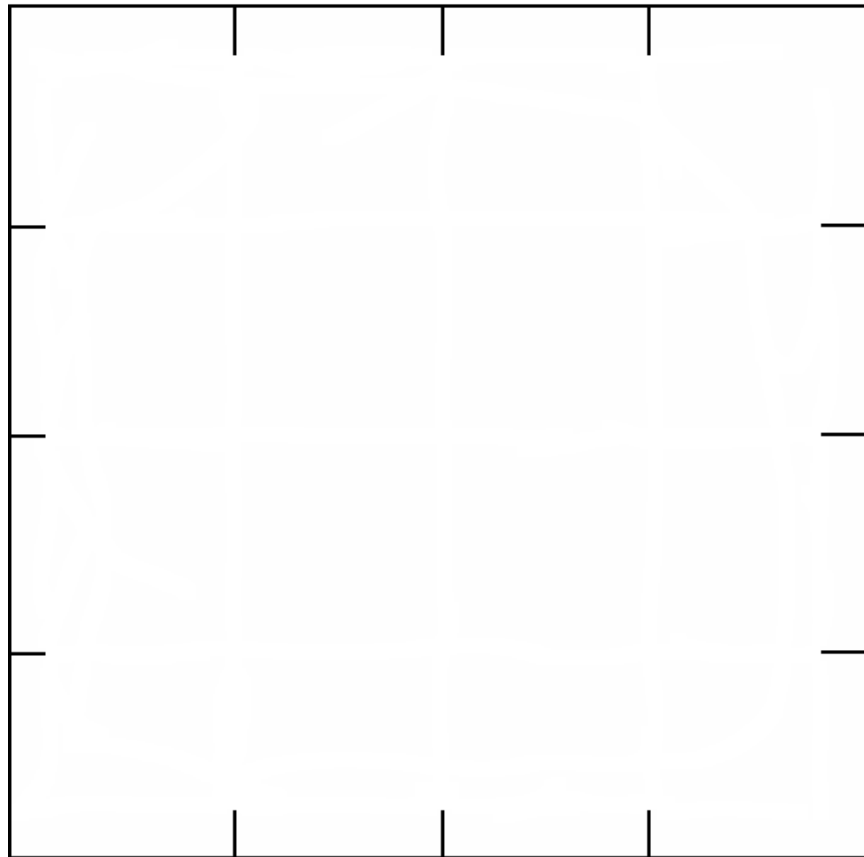
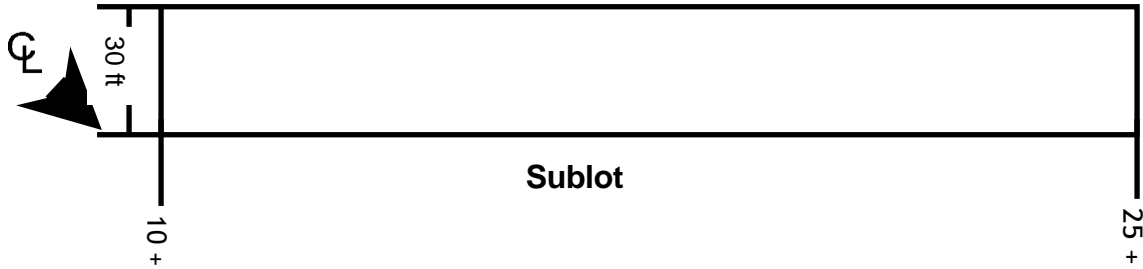

Sampling Unit (not to scale)  
12 ft. by 12 ft.

5. Sample a coarse aggregate being loaded by a 60 ft. long conveyor. The plant will operate from 7:00 A.M. until 4:30 P.M. Beginning with the same random number as Problem 4 (0.355), develop the sampling plan.



6. The weight of material required from the field sample to be used in an actual test is called:
- (a) A subplot
  - (b) An increment
  - (c) A test portion
7. Nominal maximum size is the largest standard sieve size listed which \_\_\_\_\_retain material when the aggregate is graded.
- (a) will not
  - (b) is permitted to
  - (c) will
8. To sample a No. 57 concrete aggregate for gradation, obtain at least:
- (a) 55 lbs
  - (b) 110 lb.
  - (c) 165 lb.
9. Sampling from a stockpile for gradation is done as a last resort because:
- (a) Climbing stockpile can be hazardous.
  - (b) Segregation is a common problem with stockpiles.
  - (c) Not true, sampling from a stockpile is the preferred method.
10. List the three general areas from which samples may be obtained in accordance with MP700.00.06.
- 1. \_\_\_\_\_
  - 2. \_\_\_\_\_
  - 3. \_\_\_\_\_

(Then turn to the next page and check the answers.)

1. (b) A field sample is taken from each subplot, and represents the material contained in that subplot.
2. (a) 144 ft.<sup>2</sup> (16 m<sup>2</sup>). See Note 1, Section 5, of MP700.00.06. If the roadway is wide enough, this area will be 12 ft. x 12 ft. If it's a shoulder 6 ft. wide, the sampling unit will be 6 ft. x 24 ft. etc.
3. (c) For roadway and conveyor belt sampling, 5 increments should be combined into a field sample.
4. Total length of lane is 2500 ft. minus 1050 ft. equals 1450 ft. So the area of the subplot is 1450 ft. x 30 ft. To find the sampling unit, we multiply the length by the random number.

$$1450 \text{ ft.} \times 0.355 = 515 \text{ ft.}$$

The mate to 0.355 in Attachment 1 (page A-48) is 0.698. So, the offset equals lane width times 0.698, or:

$$30 \text{ ft.} \times 0.698 = 21 \text{ ft.}$$

We have now located a random point at Station 10+50 plus 515 ft. which equals Station 15+65, offset left. 21 ft. The sampling unit could be located with either a corner or the center at the random point, and a picture would look something like this:

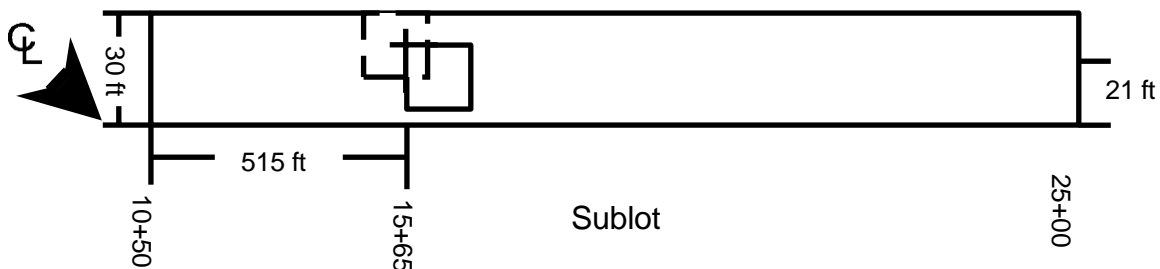

To locate the increments within the sampling unit, take the five pairs of random numbers following the numbers used above and multiply by the dimensions of the sampling unit.

$$0.331 \times 12 \text{ ft.} = 4 \text{ ft.}$$

$$0.066 \times 12 \text{ ft.} = 1 \text{ ft.}$$

$$0.979 \times 12 \text{ ft.} = 12 \text{ ft.}$$

$$0.627 \times 12 \text{ ft.} = 8 \text{ ft.}$$

$$0.458 \times 12 \text{ ft.} = 5 \text{ ft.}$$

$$0.179 \times 12 \text{ ft.} = 2 \text{ ft.}$$

$$0.170 \times 12 \text{ ft.} = 2 \text{ ft.}$$

$$0.399 \times 12 \text{ ft.} = 5 \text{ ft.}$$

$$0.595 \times 12 \text{ ft.} = 7 \text{ ft.}$$

$$0.137 \times 12 \text{ ft.} = 2 \text{ ft.}$$

Lay out the sampling unit like this:

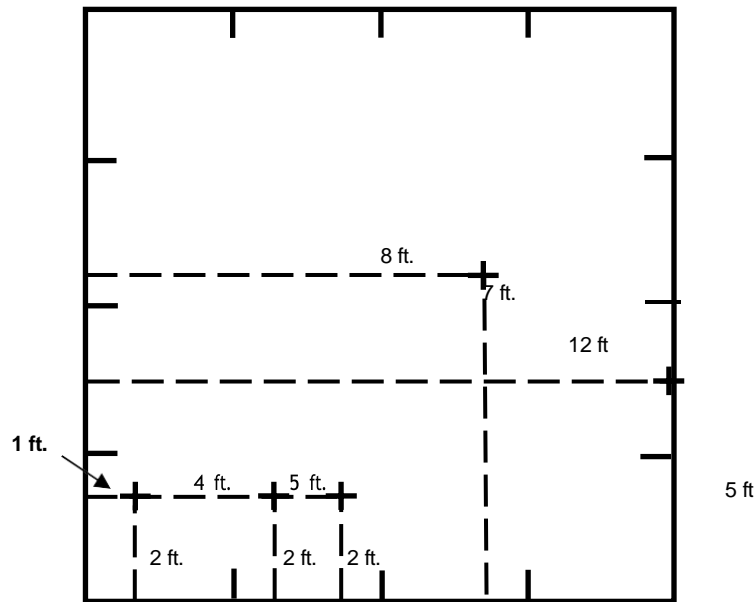

**Sampling Unit**  
12 ft. by 12 ft.  
(Not to Scale)

5. If the sampling frequency requires one sample per day, multiply the total operating time by the random number to locate the sampling unit. Thus, the plant would be operating 9 hours and 30 minutes, or a total of 570 minutes, and  $0.355 \times 570 = 202$  minutes. You should be prepared to get the sample at 10:22 A.M. The distances for locating the increments along the conveyor would be:

$$0.331 \times 60 \text{ ft.} = 20 \text{ ft.}$$

$$0.066 \times 60 \text{ ft.} = 4 \text{ ft.}$$

$$0.979 \times 60 \text{ ft.} = 59 \text{ ft.}$$

$$0.627 \times 60 \text{ ft.} = 38 \text{ ft.}$$

$$0.458 \times 60 \text{ ft.} = 27 \text{ ft.}$$

If you wanted to get an A.M. and P.M. sample, you could proceed as follows:

7:00 A.M. - Noon

Noon - 4:30 P.M.

#### Sampling Unit Location

$5 \text{ hr.} \times 60 \text{ min.} \times 0.355 = 107 \text{ min.}$	$4.5 \text{ hr.} \times 60 \text{ min.} \times 0.698 = 188 \text{ min.}$
(or 1 hr. 47 min.)	(or 3 hr. 8 min.)

$7:00 \text{ A.M.} + 1 \text{ hr.} 47 \text{ min.} = 8:47 \text{ A.M.}$	$12:00 \text{ P.M.} + 3 \text{ hr.} 8 \text{ min.} = 3:08 \text{ P.M.}$
---	---

#### Increment Location

A. M. Sample	P. M. Sample
$0.331 \times 60 \text{ ft.} = 20 \text{ ft.}$	$0.179 \times 60 \text{ ft.} = 11 \text{ ft.}$
$0.066 \times 60 \text{ ft.} = 4 \text{ ft.}$	$0.170 \times 60 \text{ ft.} = 10 \text{ ft.}$
$0.979 \times 60 \text{ ft.} = 59 \text{ ft.}$	$0.399 \times 60 \text{ ft.} = 24 \text{ ft.}$
$0.627 \times 60 \text{ ft.} = 38 \text{ ft.}$	$0.595 \times 60 \text{ ft.} = 36 \text{ ft.}$
$0.458 \times 60 \text{ ft.} = 27 \text{ ft.}$	$0.137 \times 60 \text{ ft.} = 8 \text{ ft.}$

In this case we would take the morning sample at 8:46 A.M. and the afternoon sample at 3:08 P.M., along the conveyor belt as indicated.

6. (c) The quantity of material actually used for a specific test is a test portion.
7. (is permitted to) You don't know when you sample whether material will be retained on the largest sieve allowed by the specifications.
8. (b) A field sample of No. 57 stone, which is 1-inch nominal maximum size, must weigh at least 110 lbs.
9. (b) Segregation is a common problem with stockpiles.
10.
  1. Roadway or Shoulder
  2. Conveyor belt
  3. Stockpile

**(This completes the chapter on sampling. Find the answers to the 10 questions on Page 2-24 and mark or highlight the answers for easy retrieval during the written part of the Aggregate Technician Exam.)**

**FIGURE 1**

**EXAMPLE OF APPARATUS FOR SAMPLING  
FROM A CHUTE DISCHARGE  
(SEE SECTION 6.1.3 OF MP 700.00.06 FOR DETAILS)**

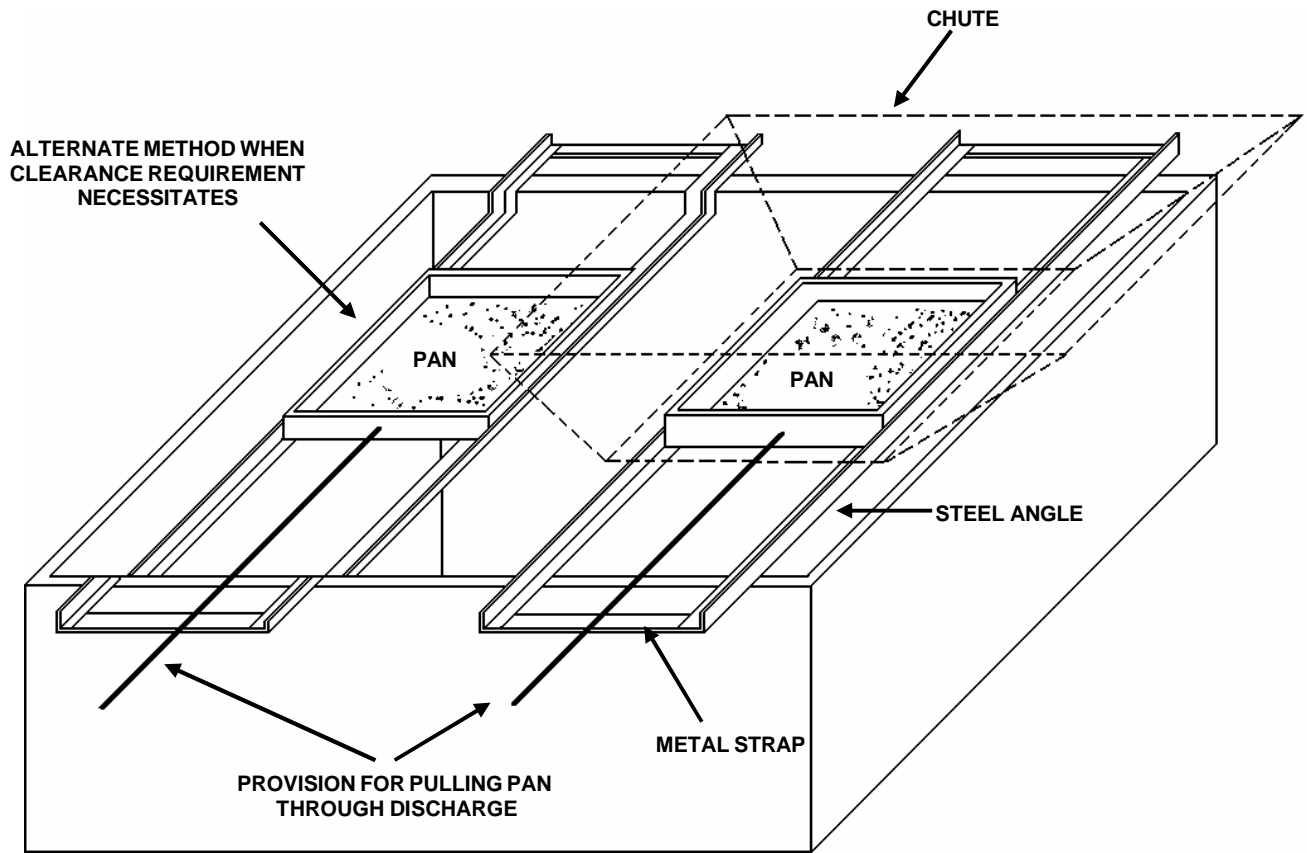

**FIGURE 2**

**METHOD OF SAMPLING FROM ROADWAY  
(SEE SECTION 6.1.1 OF MP 700.00.06 FOR DETAILS)**

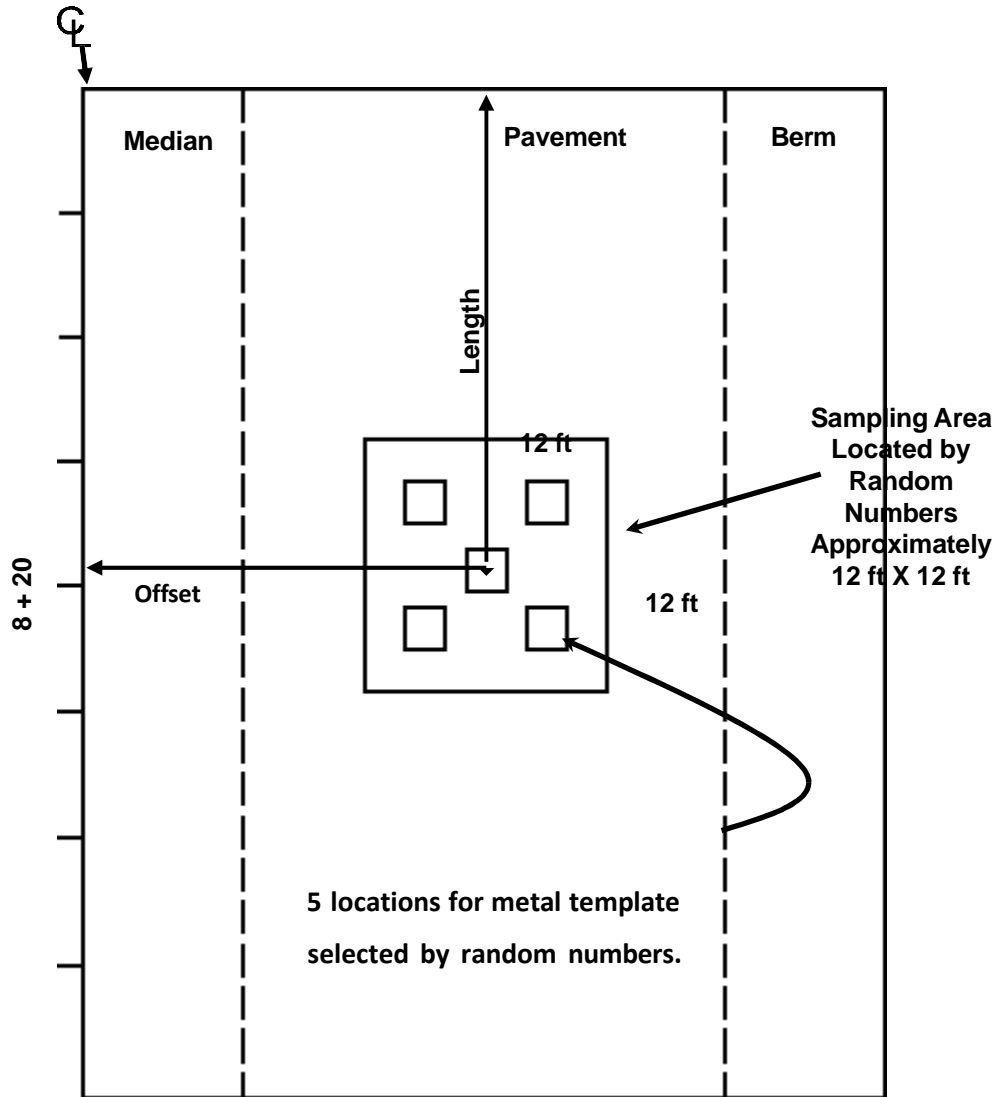

**FIGURE 3**

**EXAMPLE OF METHOD FOR SAMPLING  
FROM A CONVEYOR BELT**

**(SEE SECTION 6.1.2 OF MP 700.00.06 FOR DETAILS)**

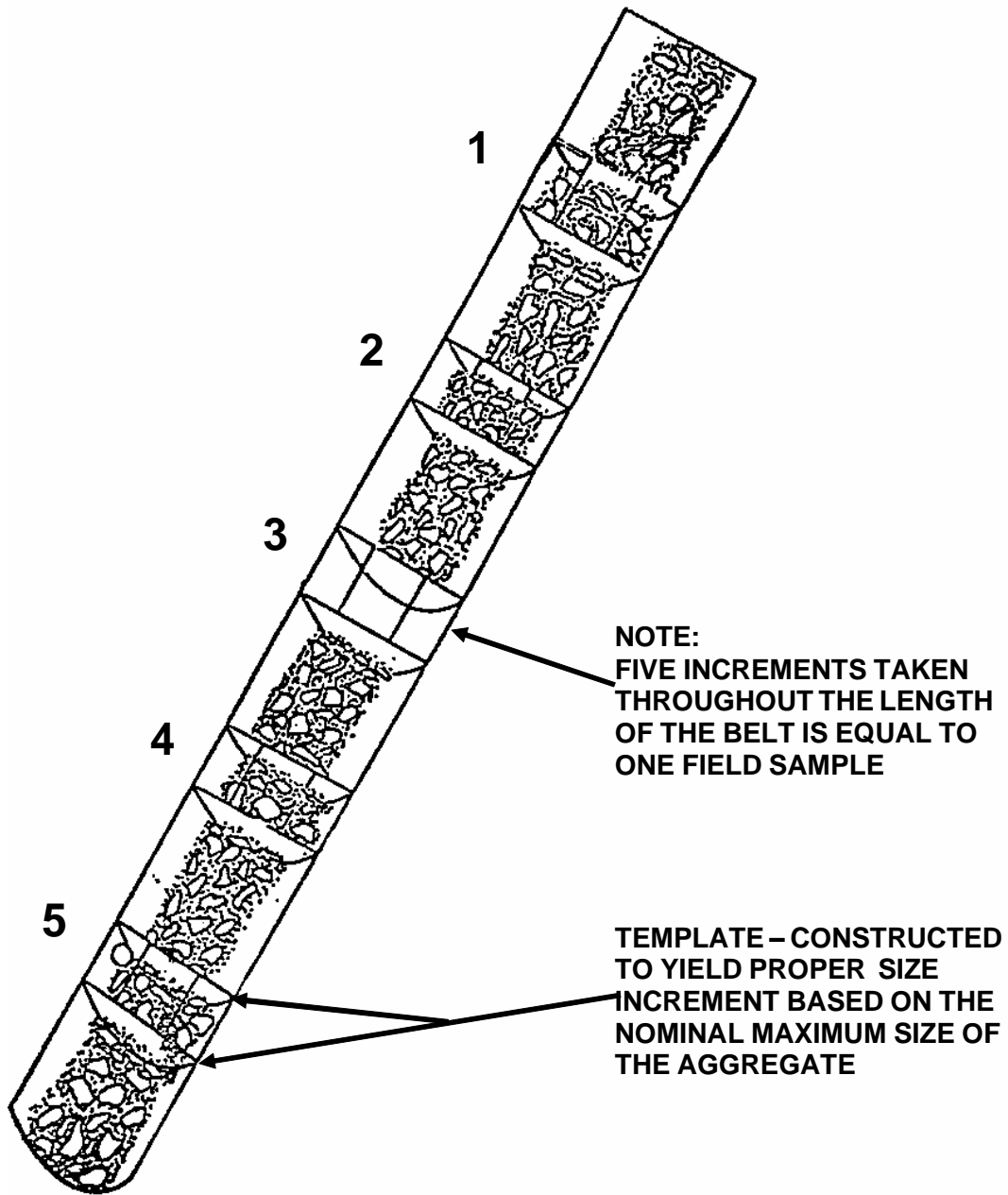



ATTACHMENT 1 From MP 700.00.06

TABLE OF RANDOM NUMBERS

1		2		3		4		5	
0.858	0.082	0.886	0.125	0.263	0.176	0.551	0.711	0.355	0.698
0.576	0.417	0.242	0.316	0.960	0.879	0.444	0.323	0.331	0.179
0.587	0.288	0.835	0.636	0.596	0.174	0.866	0.685	0.066	0.170
0.068	0.391	0.139	0.002	0.159	0.423	0.629	0.631	0.979	0.399
0.140	0.324	0.215	0.358	0.663	0.193	0.215	0.667	0.627	0.595
0.574	0.601	0.623	0.855	0.339	0.486	0.065	0.627	0.458	0.137
0.966	0.589	0.751	0.308	0.025	0.836	0.200	0.055	0.510	0.656
0.608	0.910	0.944	0.281	0.539	0.371	0.217	0.882	0.324	0.284
0.215	0.355	0.645	0.450	0.719	0.057	0.287	0.146	0.135	0.903
0.761	0.883	0.711	0.388	0.928	0.654	0.815	0.570	0.539	0.600
0.869	0.222	0.115	0.447	0.658	0.989	0.921	0.924	0.560	0.447
0.562	0.036	0.302	0.673	0.911	0.512	0.972	0.576	0.838	0.014
0.481	0.791	0.454	0.731	0.770	0.500	0.980	0.183	0.385	0.012
0.599	0.966	0.356	0.183	0.797	0.503	0.180	0.657	0.077	0.165
0.464	0.747	0.299	0.530	0.675	0.646	0.385	0.109	0.780	0.699
0.675	0.654	0.221	0.777	0.172	0.738	0.324	0.669	0.079	0.587
0.269	0.707	0.372	0.486	0.340	0.680	0.928	0.397	0.337	0.564
0.338	0.917	0.942	0.985	0.838	0.805	0.278	0.898	0.906	0.939
0.130	0.575	0.195	0.887	0.142	0.488	0.316	0.935	0.403	0.629
0.011	0.283	0.762	0.988	0.102	0.068	0.902	0.850	0.569	0.977
0.683	0.441	0.572	0.486	0.732	0.721	0.275	0.023	0.088	0.402
0.493	0.155	0.530	0.125	0.841	0.171	0.794	0.850	0.797	0.367
0.059	0.502	0.963	0.055	0.128	0.655	0.043	0.293	0.792	0.739
0.996	0.729	0.370	0.139	0.306	0.858	0.183	0.464	0.457	0.863
0.240	0.972	0.495	0.696	0.350	0.642	0.188	0.135	0.470	0.765

## **CHAPTER 2 STUDY QUESTIONS**

1. Where may aggregate used to check the quality of the sample be taken from?
2. Where is the best place for gradation samples to be taken?
3. What steps should be taken for collecting aggregate samples sent to the Central Laboratory?
4. What is the T # designation of the form required to be with each sample sent in to the lab?
5. Who is responsible for supplying any special equipment needed to take samples in accordance with Material Procedure 700.00.06?
6. What is the importance of using random numbers in sampling?
7. Which is more important: taking a representative sample or correctly running all tests for that sample?
8. Why is shoulder sampling different from roadway sampling?
9. What are the steps for planning a Sampling Program?
10. Name the Material Procedure for Aggregate Sampling.  
MP \_\_\_\_\_

**NOTES:**



## **CHAPTER 3**

### **SIEVE ANALYSIS, $\bar{A}$ (A-BAR), AND ACCEPTANCE PROCEDURES**

#### **PART I - INTRODUCTION TO GRADATIONS**

Aggregate sieve analysis procedures are governed by the Standard Specifications which in most cases require that the test methods to be followed are AASHTO T 11 Material Finer Than the 75- $\mu$ m (No. 200) Sieve in Mineral Aggregates by Washing and T 27 Sieve Analysis of Fine and Coarse Aggregates.

The general requirements which are common to any sieve analysis will be studied first and then individual situations will be approached such as sieve analysis of coarse aggregate, fine aggregate, and an aggregate containing a combination of both coarse and fine aggregate.

In 1996, the Division of Highways adopted the metric system. Sieves used were referred to in metric equivalent units, however, as of January 1, 1998, the Division of Highways has reverted to designing projects in English units. Although according to AASHTO M 92, the metric sieve sizes are the standard and the English sieve sizes are the alternate. This manual has been edited to abide by the Division of Highways preferred English format. Since there are still projects that have not been completed that were designed in metric units, the metric units will appear in parentheses ( ) after the English units. A table listing the small standard metric sieve sizes and their English equivalents can be seen on page 3-91.

**Sieve analysis is nothing more than the separation of a material based on particle size.** Separation is achieved by introducing material into a stacked series of successively smaller sized sieves, or screens, and shaking them until little or no material continues to pass through any of the sieves. Sieves are differentiated by the size of the square openings in a wire mesh (Fig. 3.1). For example, a sieve with mesh containing

square openings 1 in. (25.0 mm) X 1 in. (25.0 mm) would be called the 1 in. (25.0 mm) sieve. A numbered sieve, such as a No. 4 (4.75 mm) sieve, has that same number of openings

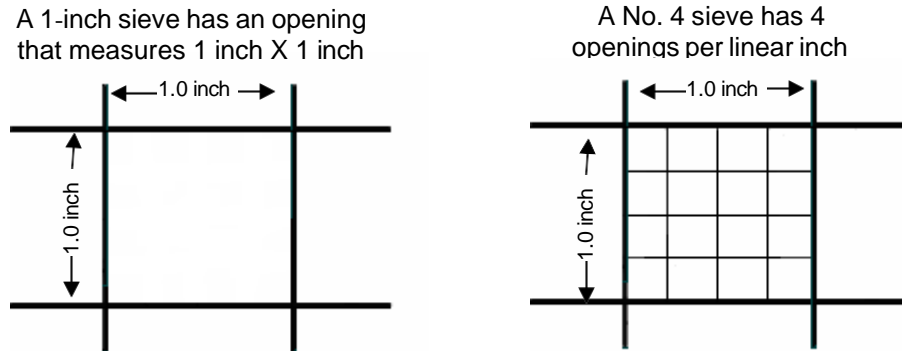

Figure 3-1

per linear inch. It would have 4 x 4 or 16 openings per square inch. Once sieving is completed there will be particles retained on each sieve which are smaller than the openings of the sieve above and larger than the openings of the sieve on which they are retained. For example, material which passes a 1 1/2 in. (37.5 mm) sieve and is retained on a 1 in. (25.0 mm) sieve would not contain any particle larger than 1 1/2 in. (37.5 mm) nor smaller than 1 in. (25.0 mm). If we picture a nest of sieves arranged in order of the size of the openings in the wire with the coarsest or largest opening at the top and the smallest at the bottom, then pass a sample through this group of sieves, it might look something like Figure 3.2.

We have effectively separated our sample into portions based on particle size. The next step in the operation is to weigh all the material which is retained on each sieve. For ease of understanding, let us say that the Initial Weight introduced into the sieves is 100 g. The weight retained on the 1 1/2 in. (37.5 mm) sieve on top is 0 g; the weight retained on the 1 in. (25.0 mm) sieve is 35 g, and so forth.

Next calculate the percent retained on each sieve. **Percentages in gradations are always calculated based on the initial weight and not the final weight.**

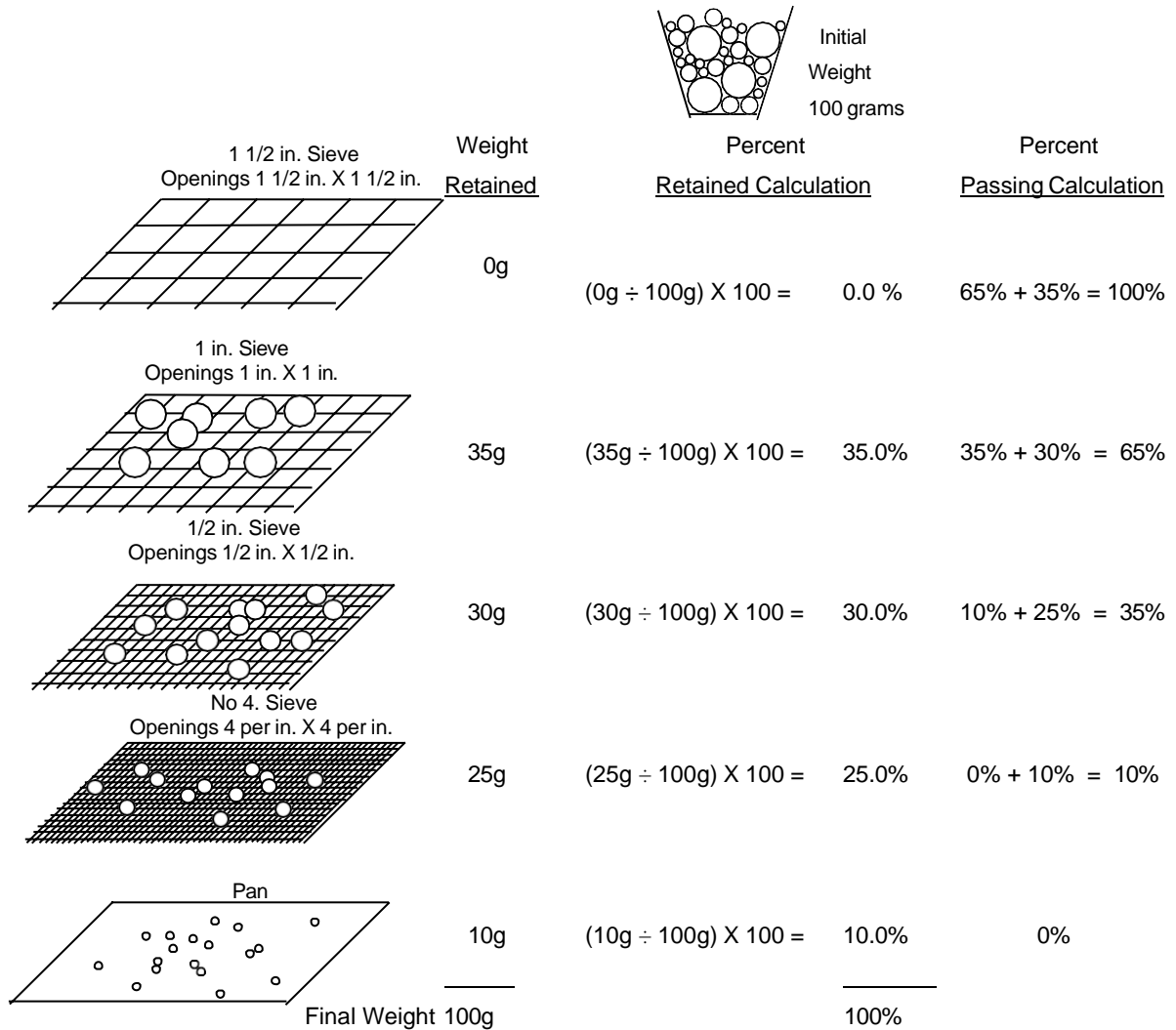

Figure 3.2

Since we are looking for the percent of the Initial Weight retained on each sieve, we may obtain this value for the 1 in. (25.0 mm) sieve by dividing the weight retained on that sieve (35 g) by the Initial Weight (100 g) and multiplying by 100.

Our formula may be restated as follows:

$$\% \text{ Retained on 1 inch sieve} = \frac{\text{weight retained on 1 inch sieve}}{\text{initial weight}} \times 100$$

To calculate percent retained on any sieve, divide the weight retained by the initial sample weight and multiply by 100.

West Virginia Specifications normally require a certain percent, or range of percent passing a given sieve, therefore, it is necessary to carry our calculation one step further. The percent passing the pan will be 0% because nothing can pass through it. Everything in the pan passed the first sieve above it. Therefore, the percent passing any sieve is equal to the sum ( $\Sigma$ ) of the percentages retained on all sieves below that sieve and the pan. This is expressed by the following formula:

$$\text{\% Passing any sieve} = \Sigma (\text{\% Ret. on all sieves below}) + \text{\% Ret. in Pan}$$

The material passing the 1/2 in. (12.5 mm) sieve would be all the material retained below that sieve which would include the material retained in the pan and on the No. 4 (4.75 mm) sieve. The percent passing the 1/2 in. (12.5 mm) sieve is as follows:

$$\text{\% Passing the 1/2 in. (12.5 mm) sieve} = \text{\% Ret. No. 4(4.75 mm) (25\%)} + \text{\% Ret. Pan (10\%)} = 35\%$$

A list of equipment and materials we will need to run AASHTO T 11 and T 27 includes:

T 11

- (a) Sieves
- (b) Container
- (c) Balance
- (d) Oven
- (e) Wetting Agent

T 27

- (a) Balance
- (b) Sieves
- (c) Oven
- (d) Mechanical Sieve Shaker



Why should a container be listed as part of the apparatus required for T 11 but was not included in T 27? Since containers are needed for the drying operation, one might think they should be listed for both tests, however after giving the matter further thought we know that the container which is referred to in T 11 is the one in which the washing operation is to take place. This requires a pan or vessel large enough to permit the sample to be covered with water and vigorously agitated without losing any of the sample. We would also want to select a container which would facilitate ease of pouring the water over the nested No. 16 (1.18 mm) and No. 200 (75  $\mu$ m) sieve. Some consideration should be given to getting the sample out of the container. We would not want to select a container which had a seam in the bottom which could retain material or a container which leaks.

After "container" on page 3-4, write the words "suitable for washing sample".

After the other items of equipment required for T 11 and T 27 listed on page 3-4, write similar descriptions.

After we have completed a short description for each item of equipment, our list may look something like this:

**T 11**

- (a) Sieves: No. 16 (1.18 mm) and No. 200 (75  $\mu$ m) conforming to AASHTO M 92
- (b) Containers suitable for washing sample
- (c) The balance shall conform to the requirements of AASHTO M 231 for the class of general-purpose balance required for the principal sample weight of the sample being tested.
- (d) Oven with constant temperature of  $230 \pm 9^{\circ}\text{F}$  ( $110 \pm 5^{\circ}\text{C}$ ).
- (e) Wetting agent - any dispersing agent such as dish washing detergent that will promote separation of fine aggregate particles.

## T 27

- (a) The balance shall conform to the requirements of AASHTO M 231 for the class of general-purpose balance required for the principal sample weight of the sample being tested.
- (b) Sieves as required meeting AASHTO M 92.
- (c) Oven with constant temperatures of  $230 \pm 9^{\circ}\text{F}$  ( $110 \pm 5^{\circ}\text{C}$ ).
- (d) Shaker that will cause the aggregate particles to bounce and turn so as to present different orientations to the sieving surface.

We have a temperature range of  $230 \pm 9^{\circ}\text{F}$  ( $110 \pm 5^{\circ}\text{C}$ ) in which to keep our oven. The drying operation is very important. If we do not dry the sample to the same degree of dryness each time, then we will be including varying amounts of moisture in the weight of material. This, in turn, will be reflected in the final result.

Some of the things which we can do to ensure a proper drying operation are:

1. ***Check oven temperature periodically to be sure that they are within the required range of  $230 \pm 9^{\circ}\text{F}$  ( $110 \pm 5^{\circ}\text{C}$ ).***
2. ***Weigh the sample periodically during its drying operation to make sure that it has been dried to a constant mass (less than 0.1% additional loss in mass).***

As previously stated on page 3-6, our balance shall conform to the requirements of AASHTO M 231 for the class of general-purpose balance required for the principal sample weight of the sample being tested. The following is a list of terminology that may be useful when referring to scales and balances:

**Principal Sample Weight:** - the weight of the entire sample being tested, or the greatest weighing made in conducting the test.

**Readability:** - The smallest fraction of a division at which the index scale can be read with ease either by estimation or by use of a vernier on a direct reading balance.

**Sensitivity:** - Weight required to produce a discernible movement in the indicating system of the balance or scale.

**Accuracy:** - Maximum permissible deviation of indications of a balance or scale from the true value within applicable tolerances.

**Capacity** – the maximum load recommended by the manufacturer.

Sieves must also meet certain requirements. Although we cannot always check all requirements for sieves as per AASHTO M 92, there are several things which we can and should check each time we use any sieve. Some conditions which would require the replacement of a sieve include: the sieve cloth is loose in the frame; the sieve wires are bent, loose, or broken; or the frame itself is split.

### **Gradation Worksheet: T300**

The form we will use for sieve analysis of coarse and fine aggregate will be the T300. A copy of this form can be seen on the next page.

There are basically 7 parts to this form. Take note of the areas listed below on the copy of the T300:

- 1) The top sample information area which includes general information about the sample and a PASS/FAIL sieve report area to the right.
- 2) Lines (A) - (I) for recording total sample weights before and after T 11 testing and as well as splitting weights for combination gradations.
- 3) Sieve Analysis for Coarse Aggregate section (center of the form) for performing calculations on coarse aggregate samples.
- 4) The C.F. section (right center) for calculating the Correction Factor in combination gradations (discussed later in this chapter).
- 5) Sieve Analysis for Fine Aggregate section (lower part of the form) for performing calculations on fine aggregate samples.
- 6) The Minus No. 200 Calculations area (lower right) for calculating the amount of material finer than the No. 200 (75  $\mu$ m) sieve.
- 7) Sample Loss or Gain area (lower center) for calculating the amount of material lost or gained during testing of the sample.

The T300 worksheet is designed to be used for all types of aggregate gradations, therefore, any sections not pertaining to the test being conducted are left blank. Use only that portion of the worksheet which is needed. ***Never erase information from the worksheet!*** Make corrections by drawing a neat line through the data to be corrected and inserting the new data above, below, or beside it. After replacing the data, initial and date the correction.

**WEST VIRGINIA DIVISION OF HIGHWAYS**  
SIEVE ANALYSIS OF FINE AND COARSE AGGREGATE (AASHTO T-27)  
MATERIALS FINER THAN NO. 200 SIEVE BY WASHING (AASHTO T-11)

Site Manager I.D.#:	Aggregate Size:	Spec Sieve Sizes	% Pass	Pass /Fail
Lab Reference Number:	Sieve Type Coarse:			
Technician:	Sieve Type Fine:			
Producer / Supplier Code:	Material Type:			
Producer / Supplier Name:	Contract #:			
Site Manager Material Code:	Project #:			
Date Sampled:	Auth #:			
Date Tested:	Item #:			
	Tons / CY			

- (A) Initial Oven Dry Mass of Total Sample..... (A) \_\_\_\_\_
- (B) Oven Dry mass of Total Sample After T-11..... (B) \_\_\_\_\_
- (C) Oven Dry Mass of Plus No. 4 Material..... (C) \_\_\_\_\_
- (D) Oven Dry Mass of Plus No. 4 Material After T-11..... (D) \_\_\_\_\_
- (E) Oven Dry Mass of Minus No. 4 Material Used in Split..... (E) \_\_\_\_\_
- (F) Combination Gradation Coarse Fraction Pan Material After Dry Sieving (K)..... (F) \_\_\_\_\_
- (G) Total Oven Dry Mass of Minus No. 4 Material (E+F)..... (G) \_\_\_\_\_
- (H) Initial Oven Dry Mass of Total Fine Sample or Mass of Minus No. 4 Material..... (H) \_\_\_\_\_
- (I) Oven Dry Mass of Total Fine Sample or Mass of Minus No. 4 Material After T-11..... (I) \_\_\_\_\_

**Sieve Analysis of Coarse Aggregate**

Sieve Size	Mass Retained $M_R$		Over Loading	% Retained $(M_R/A) \times 100$	Percent Passing	Reported Percent Passing	Material Specifications	
	Regular	Combination					Low	High
4 in. (100mm)								
1 in. (25mm)								
3/4 in. (19mm)								
1/2 in. (12.5mm)								
3/8 in. (9.5mm)								
No. 4 (4.75mm)								
(J) Pan .....								
(K) Combination Grad. Pan .....								
(L) Loss By T-11.....								
(M) Final Total ( $\Sigma M_R$ )								

C. F. = (G) + (P)  
C. F. = \_\_\_\_\_ + \_\_\_\_\_  
C. F. = \_\_\_\_\_

**Sieve Analysis of Fine Aggregate**

Sieve Size	Mass Retained $M_R$		Over Loading	% Retained $(M_R/(H+R)) \times 100$	Percent Passing	Reported Percent Passing	Material Specifications	
	Regular	Combination					Low	High
No. 8 (2.36mm)								
No. 16 (1.18mm)								
No. 20 (850 $\mu$ m)								
No. 40 (425 $\mu$ m)								
No. 100 (150 $\mu$ m)								
No. 200 (75 $\mu$ m)								
(N) Pan.....								
(O) Loss By T-11.....								
(P) Final Total Fine Sample ( $\Sigma M_R$ ).....								
(Q) Final Total - No. 4 ( $\Sigma M_R$ ).....								
(R) Combined Total (M+Q).....								
(S) Sample Loss or Gain	(A-M) or (M-A).....							
	(H-P) or (P-H).....							
	(A-R) or (R-A).....							
(T) Percentage of Initial OD Mass ( $(S/A) \times 100$ ) or ( $(S/H) \times 100$ )								

Name: \_\_\_\_\_

Signature: \_\_\_\_\_

Date: \_\_\_\_\_

Remarks:	<b>Pass/Fail</b>	Lab Info Only: <input type="checkbox"/>

### **General Weighing, Calculating, and Reporting Accuracies:**

To maintain consistency in performing and calculating gradation analyses, we would like to recommend some guidelines for accuracies. All weights should be recorded to the nearest 0.1 g for coarse and fine aggregate samples. If the balance used for coarse aggregate samples weighs to the nearest 1 g, this accuracy is acceptable but all fine samples must be weighed to the nearest 0.1 g. During testing, all weights should be determined using the same balance for coarse or fine aggregate. When figuring the “% Retained”, the percentages should be calculated to the nearest 0.1%. When figuring the “Percent Passing”, the percentages should be calculated to the nearest 0.1% for sieves above the No. 200 (75 μm) sieve. The No. 200 (75 μm) percent passing should be **truncated** (cut off) at the 0.01% place (this will be clearer in the first example). When determining the “Reported Percent Passing”, these percentages should be **rounded** to the nearest 1% except for the No. 200 (75 μm) sieve which should be rounded to the nearest 0.1%. These accuracies will become clearer in the following example.

**\*Note:** The percentages passing above the No. 200 sieve will be recorded to the 0.01 place since the minus No. 200 value will be added to the percent retained value for the next larger sieve. Example: 2.34 + 1.8 = 4.14

### **Simple Gradation Exercise**

1. The following gradation was completed on a #57 limestone.
2. Complete the calculations for the Percent Retained on each sieve as was done in Figure 3.2 using the formula:

$$\text{Percent Retained} = \frac{\text{Weight Retained}}{\text{Initial Oven Dry weight of Total Sample}} \times 100$$

3. Determine the Percent Passing each sieve as was done in Figure 3.2.
4. Round the results as discussed above.
5. Check your answers on page 3-12.

Line (A) Oven Dry Weight of Total Sample

10884.0

Sieve Size	Weight Retained	Percent Retained M.R. / (A) x 100	Percent Passing	Reported Percent Passing
1 1/2 in. (37.5 mm)	0.0			
1 in. (25.0 mm)	541.4			
3/4 in. (19.0 mm)	1425.7			
1/2 in. (12.5 mm)	5240.2			
3/8 in. (9.5 mm)	2047.4			
No. 4 (4.75 mm)	765.8			
No. 8 (2.36 mm)	647.3			
No. 200 (75 μm)	178.2			
Pan	15.7			
Final Weight				

Line (A) Oven Dry Weight of Total Sample

10884.0

Sieve Size	Weight Retained	Percent Retained M.R. / (A) x 100	Percent Passing	Reported Percent Passing
1 1/2 in. (37.5 mm)	0.0	0.0 %	99.64 %	100 %
1 in. (25.0 mm)	541.4	5.0 %	94.64 %	95 %
3/4 in. (19.0 mm)	1425.7	13.1 %	81.54 %	82 %
1/2 in. (12.5 mm)	5240.2	48.1 %	33.44 %	33 %
3/8 in. (9.5 mm)	2047.4	18.8 %	14.64 %	15 %
No. 4 (4.75 mm)	765.8	7.0 %	7.64 %	8 %
No. 8 (2.36 mm)	647.3	5.9 %	1.74 %	2 %
No. 200 (75 µm)	178.2	1.6 %	0.14 %	0.1 %
Pan	15.7	0.14424 %		
Final Weight	10861.7			



## PART II

### **COARSE AGGREGATE GRADATIONS**

We are now ready to prepare an actual sample for particle size distribution analysis, or gradation analysis. One of the best ways to demonstrate the proper technique in performing a gradation analysis is to illustrate the process step by step. Page 3-14 shows an example of a coarse gradation calculated on a T300 for an AASHTO No. 57 limestone coarse aggregate for Portland Cement Concrete. We will now illustrate the steps necessary to perform this gradation analysis.

#### **Step (ONE) - Sample Preparation:**

When AASHTO T 27 Section 7 on “Sampling” is read, you will note that first we shall inspect our field sample and confirm that it was obtained in accordance to procedures described in Chapter 2. Next, we will review the sample documentation which should accompany all samples taken for testing, a T100. (*A copy of the Sample Information sheet created when first entering a sample into SiteManager can be substituted for a T 100.*) A blank copy of this form can be found on page A-70. From this document, we can determine the type and size of material in the field sample and other pertinent information. The identification of the sample or laboratory number, the date the test was started and the name of the technician(s) conducting the test should be recorded on the T300.

We are now ready to choose the sieves necessary to determine the gradation of our sample. The required sieves are governed by our Standard Specifications for Roads and Bridges. These specifications include ranges for percent passing on the specified sieves. Specification sieves and their ranges have been developed to control the particle sizes for aggregates designated for different purposes. Percent passing specifications for AASHTO **sized** aggregates can be found in AASHTO M 43 and in Section 703 (Table 703.4) of the WV Standard Specifications. Recall that this chart has been reproduced as Table 1, Chapter 1 (page 1-23). We may wish to include some sieves not required by specifications to prevent overloading on any one sieve. For example, if we know that too large a percentage of a sample will be retained on the

T300E  
Rev 2021-06-14

**WEST VIRGINIA DIVISION OF HIGHWAYS**  
SIEVE ANALYSIS OF FINE AND COARSE AGGREGATE (AASHTO T-27)  
MATERIALS FINER THAN NO. 200 SIEVE BY WASHING (AASHTO T-11)

Site Manager I.D.#:	Aggregate Size: Straight User Input	Spec Sieve Sizes	% Pass	Pass /Fail
Lab Reference Number:	Sieve Type Coarse: Large Screen Sieve	1-1/2 in. (37.5mm)	100	Pass
Technician:	Sieve Type Fine: Large Screen Sieve	1 in. (25mm)	99	Pass
Producer / Supplier Code:	Material Type: Lime Stone	1/2 in. (12.5mm)	40	Pass
Producer / Supplier Name:	Contract #:	No. 4 (4.75mm)	3	Pass
Site Manager Material Code:	Project #:	No. 8 (2.36mm)	2	Pass
Date Sampled:	Auth #:	No. 200 (75µm)	1.5	Pass
Date Tested:	Item #:			
	Tons / CY			

- (A) Initial Oven Dry Mass of Total Sample..... (A) 10336.2
- (B) Oven Dry mass of Total Sample After T-11..... (B) 10219.5
- (C) Oven Dry Mass of Plus No. 4 Material..... (C) \_\_\_\_\_
- (D) Oven Dry Mass of Plus No. 4 Material After T-11..... (D) \_\_\_\_\_
- (E) Oven Dry Mass of Minus No. 4 Material Used in Split..... (E) \_\_\_\_\_
- (F) Combination Gradation Coarse Fraction Pan Material After Dry Sieving (K)..... (F) \_\_\_\_\_
- (G) Total Oven Dry Mass of Minus No. 4 Material (E+F)..... (G) \_\_\_\_\_
- (H) Initial Oven Dry Mass of Total Fine Sample or Mass of Minus No. 4 Material..... (H) \_\_\_\_\_
- (I) Oven Dry Mass of Total Fine Sample or Mass of Minus No. 4 Material After T-11..... (I) \_\_\_\_\_

**Sieve Analysis of Coarse Aggregate**

Sieve Size	Mass Retained M <sub>R</sub>		Over Loading	% Retained (M <sub>R</sub> /A)x100	Percent Passing	Reported Percent Passing	Material Specifications	
	Regular	Combination					Low	High
1-1/2 in. (37.5mm)	0.0		ok	0.0	99.99	100.00		100
1 in. (25mm)	61.4		ok	0.6	99.39	99.00	95	100
3/4 in. (19mm)	2104.7		ok	20.4	78.99	79.00		
1/2 in. (12.5mm)	4013.2		ok	38.8	40.19	40.00	25	60
3/8 in. (9.5mm)	2270.6		ok	22.0	18.19	18.00		
No. 4 (4.75mm)	1564.4		ok	15.1	3.09	3.00	0	10

- (J) Pan ..... \_\_\_\_\_
  - (K) Combination Grad. Pan ..... \_\_\_\_\_
  - (L) Loss By T-11 ..... 116.7
  - (M) Final Total (Σ M<sub>R</sub>) ..... 10,131.0
- C. F. = (G) + (P)
- C. F. = \_\_\_\_\_ + \_\_\_\_\_
- C. F. = \_\_\_\_\_

**Sieve Analysis of Fine Aggregate**

Sieve Size	Mass Retained M <sub>R</sub>		Over Loading	% Retained (M <sub>R</sub> /HorA) x100	Percent Passing	Reported Percent Passing	Material Specifications	
	Regular	Combination					Low	High
No. 8 (2.36mm)	64.5		ok	0.6	2.49	2.00	0	5
No. 200 (75µm)	101.9		ok	1.0	1.49	1.50	0	1.5

- (N) Pan ..... 37.9
  - (O) Loss By T-11 ..... \_\_\_\_\_
  - (P) Final Total Fine Sample (Σ M<sub>R</sub>) ..... \_\_\_\_\_
  - (Q) Final Total - No. 4 (Σ M<sub>R</sub>) ..... 204.3
  - (R) Combined Total (M+Q) ..... 10335.3
  - (S) Sample Loss or Gain  
(A-M) or (M-A) ..... \_\_\_\_\_  
(H-P) or (P-H) ..... \_\_\_\_\_  
(A-R) or (R-A) ..... 0.9
  - (T) Percentage of Initial OD Mass ((S/A)x100) or ((S/H)x100) ..... 0.0
- |            |
|------------|
| Name:      |
| Signature: |
| Date:      |

Remarks: <b>Pass</b>	Lab Info Only: <input type="checkbox"/>
----------------------	---

1/2 in. (12.5 mm) sieve, we would want to include a 3/4 in. (19.0 mm) sieve which is the next standard sieve above the 1/2 in. (12.5 mm) sieve, even though it may not be required by the governing specifications. Experience in conducting gradations on material from a particular source will be the best guide in determining which interceptor sieves are necessary. Specification and interceptor sieve sizes should be entered in the "Sieve Size" column and specification ranges should be entered on the lines adjacent to their respective sieve sizes in the "Material Spec's" column. Note where the sieves have been entered on the T300 on page 3-14. Assuming that our past experience has shown that we will require the 3/4 in. (19.0 mm) and 3/8 in. (9.5 mm) sieves as interceptors for samples from this particular source, note these on our T300. Also note the specified percent passing ranges listed on the lines for the specification sieves.

Field samples taken as specified in MP700.00.06 contain too much material to be tested in a single gradation analysis. Usually field samples contain about 4 to 5 times the amount needed for a test sample. Therefore, we must reduce the field sample to a workable **test portion** size. The first question is: "How much of the field sample is required for an adequate test portion?" MP700.00.06 (AASHTO T 2) contains a chart which sets forth the minimum weight of the test portion based on the nominal maximum size of the aggregate to be tested. MP 700.00.06 also states that **nominal maximum size** is *the largest standard sieve size listed in the applicable specifications upon which any material is permitted to be retained*. For example, if we have a sample for which specifications require 100% to pass the 2 in. (50 mm) sieve and 95-100% passing the 1 1/2 in. (37.5 mm) sieve, then the first standard sieve size upon which material may be retained is the 1 1/2 in. (37.5 mm) sieve and the nominal maximum size is 1 1/2 in. (37.5 mm).

Now look at MP700.00.06 (Table II) and determine the proper weight for a test portion for our example AASHTO No. 57 aggregate.

When we look at Table 1 in Chapter 1 (**page 1-23**) of this manual, we see that the nominal maximum size for a No. 57 aggregate is 1 in. (25.0 mm). Next note that in Table II of MP700.00.06 (**page A-47**), the proper test portion weight for a 1 in. (25.0 mm) nominal maximum size is at least 10 kg, or 10,000 g.

After having determined the proper test portion size, the next question is how do we reduce the size of the field sample. We must reduce the sample in such a way that we do not introduce any bias into the sample in order to keep it truly representative of the material sampled in the field. The splitting operation is described in AASHTO R76 or ASTM C702. Two common methods are; (1) the use of a mechanical splitter or (2) quartering of the sample. In either case, the splitting operation shall be conducted so that the sample is halved. One half is either stored or discarded and the other half is introduced into the splitter and the operation continued until the desired test portion size is obtained. The sample can be moist to help prevent segregation and loss of fines during the splitting operation but not wet enough to clog the splitter with clumped material. When using a mechanical splitter, the openings must be set at least 50% greater than the nominal maximum size of the aggregate.

After we have obtained close to the correct test portion size from the field sample, what would our next step be? Would we:

- (a) Weigh the sample?
- (b) Wash the sample?
- (c) Oven dry the sample?

The correct answer is to dry the sample since all weights must be determined while the sample is in a dry condition. We will now place our sample in the oven which is maintained at a constant temperature of  $230 \pm 9^{\circ}\text{F}$  ( $110 \pm 5^{\circ}\text{C}$ ), and dry the sample until it reaches a constant weight. **The minimum test portion weights listed in Table II of MP700.00.06 are oven dry weights.**

This requires the weight after splitting be slightly higher than the minimum weight for a given nominal maximum sized aggregate. You should allow for some weight loss during oven drying due to various amounts of moisture in different samples. The sample is weighed after it is removed from the oven and allowed to cool to room temperature. This weight must conform to the minimum weight in Table II of MP700.00.06.

For our No. 57 example, let us assume that the Oven Dry Weight was 10,336.2 g. This is to be recorded on Line (A), the "Initial Oven Dry Mass of Total Sample", of the T300 to an accuracy of 0.1 g, as recommended in Part I of this chapter. Note where this has been recorded on our T300 (page 3-14).

**Step (TWO) - T 11 Wash Test (If Required):**

Now that we have prepared our sample, dried it to a constant weight, weighed it and entered the weight on our worksheet (Form T300) we are ready to conduct AASHTO T 11 Method B (*WV uses only **Method B** which requires a wetting agent*) to determine the amount of material finer than the No. 200 (75  $\mu\text{m}$ ) sieve by washing.

The following is a brief summary of the remaining steps necessary to conduct T 11;

- (a) Place sample in suitable container, cover with water and add wetting agent.
- (b) Agitate vigorously.
- (c) Immediately pour over the nested No. 16 (1.18 mm) and No. 200 (75  $\mu\text{m}$ ) sieves leaving as few particles as possible.
- (d) Continue washing until the wash water is clear indicating all minus No. 200 (75  $\mu\text{m}$ ) material has been removed.
- (e) All material retained on the sieves is returned to the washed sample.
- (f) The washed sample is dried to a constant weight.
- (g) Cool to room temperature and weigh.

The sample should be placed in a suitable container, covered with water containing a sufficient amount of wetting agent and stirred with a large spoon or other mechanical device which will remove the fine particles and suspend them in the water. Water pressure may also be used to agitate the sample, but care must be taken not to use excess pressure causing loss of material. Residue from stirring devices should be rinsed into the container. It is necessary to remove the wash water quickly after agitating because some of these fine particles will settle out rapidly. The wash water must be poured slowly and carefully through the nested No. 16 (1.18 mm) and No. 200 (75  $\mu\text{m}$ ) sieves, leaving as much of the sample in the container as possible while making sure all the wash water passes through the nested sieves without overflowing.

Continue the washing operation until the wash water is clear, indicating all of the minus No. 200 (75  $\mu\text{m}$ ) material has been removed. Then any material retained on the nested sieves [No. 16 (1.18 mm) and No. 200 (75  $\mu\text{m}$ )] is returned to the washed sample. The entire washed sample is placed in a drying pan, taking care to rinse all portions of the sample from the wash container. If the drying pan is in danger of overflowing, the excess water may be decanted, but this must be done over the No. 200 (75 $\mu\text{m}$ ) sieve.

All material on the sieve must then be rinsed into the drying pan again. The sample is then placed in an oven maintained at a constant temperature of  $230 \pm 9^{\circ}\text{F}$  ( $110 \pm 5^{\circ}\text{C}$ ) and dried to a constant weight. After the sample is cooled to room temperature it is weighed and this reading is placed on our worksheet (T300) on Line B "Oven Dry Mass of Total Sample After T 11". Note that the mass after T 11 for our No. 57 limestone is 10219.5 g. Check where this mass has been recorded on page 3-14.

The weight loss by the T 11 wash test can now be determined. This is done by subtracting the Oven Dry Mass of Total Sample after T 11 from the Initial Oven Dry Mass of Total Sample (Line A minus Line B on our worksheet). This difference is recorded on Line (L) of the T300 and in the "Coarse -No. 200 Wet" space of the "Minus No. 200 Calculations" area. Note how and where this weight was calculated on page 3-14.

### **Step (THREE) - Dry Sieving:**

Whether we have subjected our test sample to a T 11 wash test or not, we are now ready to dry sieve our test sample. We must first consider the equipment necessary to dry sieve the material. Specification and interceptor sieves must meet the requirements of ASTM E11. All equipment should be kept clean and in satisfactory working order. Always check each sieve prior to use for loose, bent or broken wires. A clean work area will aid in preventing errors and increases efficiency. With this in mind, we are ready to dry sieve our test sample.

Typically, coarse aggregate samples are sieved using a large mechanical shaker, having large rectangular sieves with frames roughly 17 in. (0.4 m) x 25 in. (0.6 m) in size. The No. 16 (1.18 mm) sieve is usually the smallest sieve used in the large mechanical shaker. Below the No. 16 size sieve, a small shaker is used having round sieves either 8 in. (203.2 mm) or 12 in. (305.4 mm) in diameter. Some coarse aggregates have specifications for sieves below the No. 16 (1.18 mm) sieve. In this case, the material retained in the pan from the large shaker is then introduced into a nested group of the smaller diameter sieves and placed into the smaller shaker.

## **THOROUGHNESS OF SIEVING**

Sieving operation shall be continued until *not more than* **0.5%** by weight of the initial total sample passes any sieve during one minute of hand sieving. At this point the sample has been sufficiently sieved. The mechanical sieving device should be periodically checked for **thoroughness of sieving** by using the hand sieving method. A suggested hand sieving check worksheet can be seen on page 3-21. An 8" diameter sieve of the same mesh opening size with both a snug fitting lid and pan are needed. A single layer of material is placed on the sieve. The material is hand sieved for one minute in the following manner: Hold the sieve in a slightly inclined position in one hand. Strike the side of the sieve sharply with the heel of the other hand and with an upward motion 25 times. Rotate the sieve about one-sixth of a turn and continue in the same manner for a total of six intervals. This should be about 150 strikes per minute in total. Remove the material from sieve and repeat this process until the entire amount retained on the original, larger sieve being checked has been hand sieved. Weigh all material in the pan. Divide this weight by the **initial** weight of the sample. The percentage must be **0.5%** or less to be thoroughly sieved. If not, equipment should be checked to determine the problem. *Thoroughness of sieving checks should be conducted at least once per month during the construction season, on **each set of sieves** for each shaker used.* The size or class of aggregate used in the check should vary each time.



WORKSHEET CM-23      12-5-95  
 WEST VIRGINIA DIVISION OF HIGHWAYS  
 MATERIALS CONTROL, SOILS, AND TESTING LABORATORY  
 WORKSHEET FOR CHECKING THOROUGHNESS OF MECHANICAL SHAKERS

ID Number:			Laboratory:			
Manufacturer:			Model:			
Date:			Technician:			
Date Last Checked:			Next Due Date:			
		1st Trial Sieving Time: Sample Weight:		2nd Trial Sieving Time: Sample Weight:		
Sieve Size	Weight Passing Sieve After One Minute Hand Sieving	% of Total Sample Weight (0.5 % Max.)	Pass or Fail	Weight Passing Sieve After One Minute Hand Sieving	% of Total Sample Weight (0.5 % Max.)	Pass or Fail
2 1/2 in. (63 mm)						
2 in. (50 mm)						
1 1/2 in. (37.5 mm)						
1 1/4 in. (31.5 mm)						
1 in. (25.0 mm)						
3/4 in. (19.0 mm)						
5/8 in. (16.0 mm)						
1/2 in. (12.0 mm)						
3/8 in. (9.5 mm)						
5/16 in. (8.0 mm)						
No. 4 (4.75 mm)						
No. 5 (4.00 mm)						
No. 8 (2.36 mm)						
No.10 (2.00 mm)						
No. 16 (1.18 mm)						
No. 20 (850 μm)						
No. 30 (600 μm)						
No. 40 (425 μm)						
No. 50 (300 μm)						
No.100 (150 μm)						
No. 200 (75 μm)						

If 1st trial meets specification requirements, then thoroughness was achieved. If not, then continue with a second trial. If after the second trial sieving requirements are not met then continue with additional trials until complete and attach all worksheets.

After sieving is complete, the material retained on each sieve (in both shakers if applicable) is weighed to the nearest 0.1 g as suggested in Part I of this chapter. This mass should be entered in the “Mass Retained  $M_R$ ” column under “Regular” for each sieve used on page 3-14. If the mass retained in the pan is material passing the No. 200 (75  $\mu\text{m}$ ) sieve, it should also be recorded in the “Coarse -No. 200 Dry” section of the “Minus No. 200 Calculations” area. Note where all these values have been entered on the T300 on page 3-14.

#### **Step (FOUR) - Sample Loss or Gain and Overloaded Sieves Check:**

At this point it is necessary to determine if this gradation is valid. Two things which could invalidate the gradation test are overloaded sieves and too much difference between our initial and final total sample masses.

The **first** requirement for a valid gradation, is that none of the sieves have been overloaded. Overloading of sieves can result in insufficient sieving and over time may damage the sieves. The quantity of material on a given sieve should be limited so that all particles have an opportunity to reach sieve openings a number of times during the sieving operation. This will give all of the particles a chance to be rotated during shaking and have an equal chance to pass through the sieve openings. Maximum retained weights, based on the sieve surface area, have been calculated according to T 27 and are listed on page 3-24.

If the weights retained on the sieves exceed the weights listed on page 3-24, then **five** things can be done to correct the problem:

1. The test portion just sieved can be split into increments, re-sieved, and the weights of the increments for each sieve added together to be used in the calculations.
2. All material from each overloaded sieve could be hand sieved, similar to the method for checking the thoroughness of sieving. The weight of the material passing is then subtracted from the overloaded sieve and added to the next lower sieve for further calculations.
3. If possible, the test portion may be re-sieved with additional “interceptor”

sieves placed in the nest above the overloaded sieve.

4. A new test portion could be split from the remaining field sample closer to the minimum weight required in MP700.00.06 for that particular aggregate size.
5. The sample may be sieved in a larger shaker with larger screens.

**If options 1 or 2 are used, this should be noted on the T300 to avoid the appearance of overloaded sieves with no corrective action.**

**MAXIMUM WEIGHTS ALLOWED ON LARGE FRAME SIEVES**

2 in.	(50.0 mm)	27,000 g
1 1/2 in.	(37.5 mm)	20,200 g
1 in.	(25.0 mm)	13,500 g
3/4 in.	(19.0 mm)	10,200 g
1/2 in.	(12.5 mm)	6,700 g
3/8 in.	(9.5 mm)	5,100 g
No. 4	(4.75 mm)	2,600 g
No. 8	(2.36 mm)	1,290 g
No. 16	(1.18 mm)	630 g

**MAXIMUM WEIGHTS ALLOWED ON 8 inch (203.2 mm) SIEVES**

No. 4	(4.75 mm)	330 g
All Smaller Sieves		200 g

**MAXIMUM WEIGHTS ALLOWED ON 12 INCH (304.8 mm) SIEVES**

6 in.	(150 mm)	25,100 g
5 in.	(125 mm)	20,900 g
4 in.	(100 mm)	16,800 g
3 in.	(75 mm)	12,600 g
2 1/2 in.	(63 mm)	10,600 g
2 in.	(50 mm)	8,400 g
1 1/2 in.	(37.5 mm)	6,300 g
1 in.	(25.0 mm)	4,200 g
3/4 in.	(19.0 mm)	3,200 g
1/2 in.	(12.5 mm)	2,100 g
3/8 in.	(9.5 mm)	1,600 g
No.4	(4.75 mm)	800 g
No.8	(2.36 mm) & smaller	500 g

Check page 3-14 to see if any of the sieves in our No. 57 aggregate gradation have been overloaded. Assume the No. 8 (2.36mm) sieve and above are 12-inch sieves, and the sieves below the No. 8 (2.36mm) sieve are 8 inch sieves.

The **second** requirement for a valid gradation is that the difference between initial and final total sample masses be less than a specified percentage of the initial oven dry weight of the total sample. Our final total mass will be the total of all the masses retained on the sieves and in the pan plus our loss by T 11. This mass ( $\Sigma M_R$  - Line M) should closely approximate the initial weight found on Line (A), the “Initial Oven Dry Mass of Total Sample”. Even if great care is taken during the testing of the material, **it is extremely rare for these numbers to be the same and is considered highly suspicious. Weights retained must not be manipulated to make these numbers the same.** Differences can be attributed to the accuracy to which we weighed the individual sample, a loss or gain of material during the sieving operation, or errors in weighing the material retained on each sieve.

The difference between initial and final total measurements can be calculated on Line (S). For a coarse aggregate test, this is done by determining the difference between the Line (M) the “Final Total – Reg. or Combo ( $\Sigma M_R$ )”, from Line (A) the “Initial Oven Dry Mass of Total Sample”. If the total weight on Line (M) is less than that on Line (A) indicating some loss of the sample, the difference is determined by subtracting the amount on Line (M) from that on Line (A). Occasionally there is some gain of material during testing. In that case the weight on Line (A) would be subtracted from that on Line (M). Once this difference has been determined the “Percentage of Initial OD Mass” can be calculated using the formula on Line (T).

According to AASHTO T 27, the difference between the total mass retained after sieving and the original mass **may not exceed 0.3 percent of the original mass**. If the difference exceeds 0.3 percent, we should suspect an error somewhere in the test. If the error cannot be located and corrected, obtain a new test portion and run another

gradation. *Gradations exceeding the 0.3 percent difference may not be used for acceptance of material.* District policy regarding this should be discussed with your Instructor or District Laboratory Coordinator. Was the example gradation valid according to the guidelines just discussed?

The “Sample Loss or Gain” and “Percentage of Initial OD Mass” have been determined on Line (M) and Line (T) on page 3-14. Note where and how they were calculated and check to see if there was too much loss or gain.

### **Step (FIVE) - Calculating the Percent Retained:**

Calculations for determining the percent of total sample retained on each sieve are performed in the same manner that we have previously discussed in Part I of this chapter (Figure 3.2, page 3-3).

$$\text{Percent Retained} = \frac{\text{Weight Retained}}{\text{Initial Oven Dry Weight of Total Sample}} \times 100$$

All of the weights in the “Mass Retained  $M_R$ ” column will be divided by the “Initial Oven Dry Mass of Total Sample” and the result multiplied by 100. These results are to be rounded to the nearest 0.1% placed into the “Percent Retained” column. This is calculated for all sieves (for the pan if there is not a No. 200 sieve requirement). The percents retained for our No. 57 limestone have been calculated and recorded on page 3-14.

### **Step (SIX) - Calculation of Percent Passing:**

Since West Virginia Specifications are based on the percent passing, it will be necessary to continue our calculations a step further. Refer to Figure 3.2 (page 3-3) where we discussed the calculations. ***The material passing any given sieve is equal to the sum of all the material retained in the pan, the material lost by washing plus all material retained on all sieves below that given sieve.*** In West Virginia, percent passing calculations for gradation analyses are conducted beginning with the bottom sieve included in the test. This is done to keep loss or gain of material from

interfering with the percent passing the smallest sieve. Gradation results, when calculated on the T300 as directed in this chapter, avoid these errors.

Figure 3.4 illustrates the calculation on the T300. For material passing the No. 200 (75 µm) sieve, the calculation is performed in the “Minus No. 200 Calculations” area. First the “Coarse -No. 200 Dry” and “Coarse -No. 200 Wet” are added and the result recorded in the “Total -No. 200” area. The “Initial Oven Dry Mass of Total Sample” is recorded in the “Init. Mass (A) or (H)” space and the indicated calculation is performed. The results are carried out to several places to ensure proper rounding later. The results are then recorded in the space at the bottom of the “Minus No. 200 Calculations” area. The minus No. 200 (75 µm) percentage calculations have been completed on page 3-14. Check to see how and where they have been completed and recorded.

No. 8 (2.36 mm)		64.5		0.6		2.49		
No. 200 (75 µm)		101.9		1.0		1.49		
(J) Pan.....		37.9	*****					
(K) Combination Grad. Pan.....		*****	*****					
(L) Loss By T-11.....		116.7						
(M) Final Total - Reg or Combo ( $\Sigma M_R$ )		10334. 8						

Coarse -No. 200 (75 µm) Dry	37.9	Fine -No. 200 (75 µm) Dry	
Coarse -No. 200 (75 µm) Wet	116.7	Fine -No. 200 (75 µm) Wet	
Total -No. 200 (75 µm)	154.6	÷ Init. Weight (A) or (H)	10336.2
	X 100 =	1.49571 %	

Figure 3.4

After this calculation is completed, record the “% Retained ( $M_R$ )” from the “Minus No. 200 Calculations” area, or the pan percentage if the No. 200 (75 µm) was not required, to the “Percent Passing” column on the line adjacent to the bottom sieve in the analysis. This will be the percent passing the bottom sieve. On page 3-14, the “Percent Passing” the No. 200 (75 µm) sieve was calculated at 1.49571%. **This number is cut off (truncated= not rounded) at the hundredths (0.01) place and recorded on the No.**

**200 (75  $\mu\text{m}$ ) sieve line as 1.49%.** This percentage is then added to the “Percent Retained” for the No. 200 (75  $\mu\text{m}$ ) sieve, in this case 1.0%, and the result is 2.49%. This is recorded on the No. 8 (2.36 mm) sieve line and represents the combined material which passed the No. 8 (2.36 mm) sieve. This calculation is continued until the percent passing has been calculated for all sieves used in the analysis.

Check the completed calculations of “Percent Passing” for all the sieves used in the analysis of our No. 57 Aggregate on page 3-14.

Once the “Percent Passing” values have been calculated, they must be rounded to the proper reporting accuracy for the method. ***Percents passing all sieves above the No. 200 (75  $\mu\text{m}$ ) sieve are to be rounded to the nearest 1%. The percent passing the No. 200 (75  $\mu\text{m}$ ) sieve is to be rounded to the nearest 0.1%.*** The properly rounded percents passing each sieve are to be recorded in the “Reported Percent Passing” column. Rounding is to be done according to the procedures described on page 1-20 of Chapter 1, starting with the bottom sieve.



Observe the example in Figure 3.5 below. The percent passing the No. 8 (2.36 mm) sieve would round to 3%.

No. 4 (4.75)		4.0		0.0		3.41	3	
No. 8 (2.36)		95.0		0.9		2.57	3	
No. 200 (75)		143.0		1.4		1.17	1.2	
(J) Pan.....		10.0	*****					
(K) Combination Grad. Pan.....		*****	*****					
(L) Loss By T-11.....		110.0						
(M) Final Total - Reg or Combo		10332						

Minus No. 200 (75 μm) Calculations

Coarse -No. 200 (75 μm) Dry	10.0	Fine -No. 200 (75 μm) Dry	
Coarse -No. 200 (75 μm) Wet	110.0	Fine -No. 200 (75 μm) Wet	
Total -No. 200 (75 μm)	120.0	÷ Init. Weight (A) or (H)	10214.0
	X 100 =	1.17485	%

Figure 3.5

**Step (SEVEN) - Evaluation Against Specifications:**

Once the “Reported Percent Passing” has been determined for all sieves, the sample can be evaluated against governing specifications. These were previously determined and recorded in the “Material Spec’s” column. Evaluation consists of determining if the “Reported Percent Passing” values fall within the specified ranges for each specification sieve. Once the sample has been evaluated a “P” for passing or an “F” for failing is entered on the line in the lower right corner of the general sample information area at the top of the T300.

The steps in conducting a **coarse aggregate gradation** are summarized as follows:

<b><u>Step ONE</u></b> -	<b>Sample Preparation</b>
<b><u>Step TWO</u></b> -	<b>T 11 Wash Test (If Required)</b>
<b><u>Step THREE</u></b> -	<b>Dry Sieving</b>
<b><u>Step FOUR</u></b> -	<b>Sample Loss or Gain and Overloaded Sieves Check</b>
<b><u>Step FIVE</u></b> -	<b>Calculation of Percent Retained</b>
<b><u>Step SIX</u></b> -	<b>Calculation of Percent Passing</b>
<b><u>Step SEVEN</u></b> -	<b>Evaluation Against Specifications</b>

The following exercise will aid in completing the calculations on an actual coarse gradation. The instructions take you step by step through the calculations on a T300 worksheet.

**Exercise 1: Coarse Gradation:**

Complete the following steps to familiarize yourself with the calculations for a coarse gradation. We will be using an AASHTO No. 57 Limestone for concrete in this example. Use the blank T300 sheet on page 3-34. A completed copy can be seen on page 3-35.

**Sample Information:**

1. Fill in the identification information about the sample.
  - a. Information at the top of the T300.
    - Field Sample #, Tech. Lab, and Date.
  - b. Aggregate Type just above the "Sieve Analysis of Coarse Aggregate" section of the T300. In this case # 57 Lmst.

**Required Sieves and Specifications Determination:**

2. Determine the required sieves and enter them on the T300.
  - a. Sieves for an AASHTO #57 and the corresponding percent passing specifications can be found in AASHTO M 43 on page 1-23 of this manual. Aggregate for concrete must meet an additional specification for the No. 200 (75  $\mu$ m) sieve which can be found in Section 703.4 of the West Virginia Standard Specifications (up to 1.5% for

crushed aggregate which would include limestone).

-Assume that a 3/4 in. (19.0 mm) and 3/8 in. (9.5 mm) sieves will be necessary interceptors for this aggregate.

- b. Enter the sieves, starting with the largest sieve first, in the "Sieve Size" column of the "Sieve Analysis of Coarse Aggregate" section on the T300.
- c. Enter the ranges for percent passing for each specification sieve in the "Material Spec's" column adjacent to the corresponding sieve.

**Sample Preparation, T 11 Wash Test, and Dry Sieving:**

3. Weights determined during testing can be seen in the table below.

Initial O. D. weight	10884.0 g	3/8 in. (9.5 mm) sieve	2504.0 g
O. D. weight after T 11	10765.0 g	No. 4 (4.75 mm) sieve	1468.0 g
1 1/2 in. (37.5 mm) sieve	0.0 g	No. 8 (2.36 mm) sieve	31.7 g
1 in. (25.0 mm) sieve	0.0 g	No. 200 (75 µm) sieve	46.2 g
3/4 in. (19.0 mm) sieve	1481.0 g	Pan	16.8 g
1/2 in. (12.5 mm) sieve	5216.0 g		

- a. Record the initial oven dry mass of the sample on Line (A) of the T300.
  - b. Record the oven dry mass after T 11 on Line (B) of the T300.
  - c. Record the masses retained in the "Regular" side of the "Mass Retained M<sub>R</sub>" column on the T300 next to the corresponding sieve.
  - d. Record the mass retained in the pan on line (J) of the T300.
  - e. Also record the mass from the pan in the "Coarse -No. 200 Dry" space in the "Minus No. 200 Calculations" area in the lower right of the T300.
4. Determine the weight loss during T 11.
- a. Subtract the mass after T 11, Line (B) from the initial oven dry mass, Line (A).
  - b. Record this difference on Line (L) on the T300.
  - c. Also record this weight in the "Coarse -No. 200 Wet" space in the "Minus No. 200 Calculations" area in the lower right of the T300.

**Overloaded Sieves and Sample Loss or Gain Check:**

5. Check for overloaded sieves.
- a. Check the masses retained on all the sieves with the maximums allowed as listed on page 3-24 .

- b. Indicate if the sieves are overloaded on the T300 with an asterisk next to the mass retained.
6. Calculate the percentage loss or gain.
- a. Add all the masses retained, pan material and T 11 loss. Record the total on Line (M).
  - b. Either subtract Line (M) from Line (A) or Line (A) from Line (M) depending on which is greater. Record this value on Line (S) in the “(A-M) or (M-A)” space.
  - c. Determine the percentage loss by using the  $((S/A) \times 100)$  formula and record the answer to the nearest 0.1% on Line (T).

**Percent Retained Calculation:**

7. Calculate the percent retained on each sieve.
- a. Divide the mass retained on each sieve by the initial oven dry mass on Line (A) and record the result in the “Percent Retained  $M_R/A \times 100$ ” column on the T300 next to the corresponding sieve.
    - Using the formula below, calculate the values to the nearest 0.1%.

$$\text{Percent Retained} = \frac{\text{Mass Retained}}{\text{Initial Oven Dry Mass of Total Sample}} \times 100$$

**Percent Passing Calculation:**

8. Calculate the Percent Passing the No. 200 (75 μm) sieve in the “Minus No. 200 Calculations” area in the lower right of the T300.
- a. Add the “Coarse -No. 200 Dry” and “Coarse -No. 200 Wet” weights and record the total in the “Total -No. 200” space.
  - b. Record the initial oven dry mass in “÷ Init. Mass (A) or (H)”.
  - c. Divide the Total -No. 200 by the initial oven dry mass and multiply by 100.
  - d. Record this percentage at the bottom of the “Minus No. 200 Calculations” area. Record this percentage to 5 decimal places (**Do not round this number**).
  - e. Move the percent passing the No. 200 (75 μm) sieve up to the “Percent Passing” column on the line adjacent to the No. 200 (75 μm) sieve. Truncate this number to two decimal places (0.01) **DO NOT ROUND THIS NUMBER**

9. Calculate the percent passing each sieve above the No. 200.
  - a. Add the percent passing the No. 200 (75  $\mu\text{m}$ ) sieve, cut off to two decimal places (**not rounded**), to the percent retained on the No. 200 (75  $\mu\text{m}$ ) sieve and record the result in the “Percent Passing” column on the No. 8 (2.36 mm) sieve line.
  - b. Repeat step (a) for all remaining sieves. Record the results to two decimal places.
  
10. Round the percent passing each sieve for reporting.
  - a. Round the percent passing the No. 200 (75  $\mu\text{m}$ ) sieve to the nearest 0.1%.
  - b. Round the percent passing for each sieve above the No. 200 (75  $\mu\text{m}$ ) sieve to the nearest 1% and record these percents in the “Reported Percent Passing” column on the T300.

**Sample Evaluation:**

11. Evaluate the sample for specification compliance.
  - a. Check to see if any of the reported percents passing fall outside the specified ranges.
  
12. Indicate passing or failing.
  - a. Record a “P” or an “F” in the “P/F/N” space in the top section of the T300.
  - b. Record the “Reported Percent Passing” only for the specification sieves in the spaces labeled “1st”, “2nd”, etc. at the top of the T300.
    - The percent passing the largest specification sieve will be listed in the “1st” space and the smallest sieve will be in the lowest consecutive numbered space.
    - The percent passing the No. 200 (75  $\mu\text{m}$ ) sieve will always be listed in the “No. 200” space if it is required.

**WEST VIRGINIA DIVISION OF HIGHWAYS**  
SIEVE ANALYSIS OF FINE AND COARSE AGGREGATE (AASHTO T-27)  
MATERIALS FINER THAN NO. 200 SIEVE BY WASHING (AASHTO T-11)

Site Manager I.D.#:  Lab Reference Number: Technician: Producer / Supplier Code: Producer / Supplier Name: Site Manager Material Code: Date Sampled: Date Tested:	Aggregate Size: Sieve Type Coarse: Sieve Type Fine: Material Type:  Contract #: Project #: Auth #: Item #: Tons / CY	Spec Sieve Sizes    % Pass    Pass /Fail

- (A) Initial Oven Dry Mass of Total Sample..... (A) \_\_\_\_\_
- (B) Oven Dry mass of Total Sample After T-11..... (B) \_\_\_\_\_
- (C) Oven Dry Mass of Plus No. 4 Material..... (C) \_\_\_\_\_
- (D) Oven Dry Mass of Plus No. 4 Material After T-11..... (D) \_\_\_\_\_
- (E) Oven Dry Mass of Minus No. 4 Material Used in Split..... (E) \_\_\_\_\_
- (F) Combination Gradation Coarse Fraction Pan Material After Dry Sieving (K)..... (F) \_\_\_\_\_
- (G) Total Oven Dry Mass of Minus No. 4 Material (E+F)..... (G) \_\_\_\_\_
- (H) Initial Oven Dry Mass of Total Fine Sample or Mass of Minus No. 4 Material..... (H) \_\_\_\_\_
- (I) Oven Dry Mass of Total Fine Sample or Mass of Minus No. 4 Material After T-11..... (I) \_\_\_\_\_

**Sieve Analysis of Coarse Aggregate**

Sieve Size	Mass Retained $M_R$		Over Loading	% Retained $(M_R/A) \times 100$	Percent Passing	Reported Percent Passing	Material Specifications	
	Regular	Combination					Low	High
4 in. (100mm)								
1 in. (25mm)								
3/4 in. (19mm)								
1/2 in. (12.5mm)								
3/8 in. (9.5mm)								
No. 4 (4.75mm)								

- (J) Pan .....
  - (K) Combination Grad. Pan .....
  - (L) Loss By T-11.....
  - (M) Final Total ( $\Sigma M_R$ ).....
- C. F. = (G) + (P)  
 C. F. = +  
 C. F. =

**Sieve Analysis of Fine Aggregate**

Sieve Size	Mass Retained $M_R$		Over Loading	% Retained $(M_R/(H+R)) \times 100$	Percent Passing	Reported Percent Passing	Material Specifications	
	Regular	Combination					Low	High
No. 8 (2.36mm)								
No. 16 (1.18mm)								
No. 20 (850µm)								
No. 40 (425µm)								
No. 100 (150µm)								
No. 200 (75µm)								

- (N) Pan.....
  - (O) Loss By T-11.....
  - (P) Final Total Fine Sample ( $\Sigma M_R$ ).....
  - (Q) Final Total - No. 4 ( $\Sigma M_R$ ).....
  - (R) Combined Total (M+Q).....
  - (S) Sample Loss or Gain  
 (A-M) or (M-A).....  
 (H-P) or (P-H).....  
 (A-R) or (R-A).....
  - (T) Percentage of Initial OD Mass  $((S/A) \times 100)$  or  $((S/H) \times 100)$
- |  |                      |         |                         |
|--|----------------------|---------|-------------------------|
|  | Coarse - No. 200 Dry |         | Fine - No. 200 Dry      |
|  | Coarse - No. 200 Wet |         | Fine - No. 200 Wet      |
|  | Total - No. 200      |         | + Init. Mass (A) or (H) |
|  |                      | x 100 = | %                       |

Name:  
  
 Signature:  
  
 Date:

Remarks:	<b>Pass/Fail</b>	Lab Info Only: <input type="checkbox"/>	

**WEST VIRGINIA DIVISION OF HIGHWAYS**  
SIEVE ANALYSIS OF FINE AND COARSE AGGREGATE (AASHTO T-27)  
MATERIALS FINER THAN NO. 200 SIEVE BY WASHING (AASHTO T-11)

Site Manager I.D.#:	Aggregate Size: Straight User Input	Spec Sieve Sizes	% Pass	Pass /Fail
Lab Reference Number:	Sieve Type Coarse: Large Screen Sieve	1-1/2 in. (37.5mm)	100	Pass
Technician:	Sieve Type Fine: Large Screen Sieve	1 in. (25mm)	100	Pass
Producer / Supplier Code:	Material Type: Lime Stone	1/2 in. (12.5mm)	38	Pass
Producer / Supplier Name:	Contract #:	No. 4 (4.75mm)	2	Pass
Site Manager Material Code:	Project #:	No. 8 (2.36mm)	2	Pass
Date Sampled:	Auth #:	No. 200 (75µm)	1.2	Pass
Date Tested:	Item #:			
	Tons / CY			

- (A) Initial Oven Dry Mass of Total Sample..... (A) 10884.0
- (B) Oven Dry mass of Total Sample After T-11..... (B) 10765.0
- (C) Oven Dry Mass of Plus No. 4 Material..... (C) \_\_\_\_\_
- (D) Oven Dry Mass of Plus No. 4 Material After T-11..... (D) \_\_\_\_\_
- (E) Oven Dry Mass of Minus No. 4 Material Used in Split..... (E) \_\_\_\_\_
- (F) Combination Gradation Coarse Fraction Pan Material After Dry Sieving (K)..... (F) \_\_\_\_\_
- (G) Total Oven Dry Mass of Minus No. 4 Material (E+F)..... (G) \_\_\_\_\_
- (H) Initial Oven Dry Mass of Total Fine Sample or Mass of Minus No. 4 Material..... (H) \_\_\_\_\_
- (I) Oven Dry Mass of Total Fine Sample or Mass of Minus No. 4 Material After T-11..... (I) \_\_\_\_\_

**Sieve Analysis of Coarse Aggregate**

Sieve Size	Mass Retained $M_R$		Over Loading	% Retained $(M_R/A) \times 100$	Percent Passing	Reported Percent Passing	Material Specifications	
	Regular	Combination					Low	High
1-1/2 in. (37.5mm)	0.0		ok	0.0	99.94	100.00		100
1 in. (25mm)	0.0		ok	0.0	99.94	100.00	95	100
3/4 in. (19mm)	1481.0		ok	13.6	86.34	86.00		
1/2 in. (12.5mm)	5216.0		ok	47.9	38.44	38.00	25	60
3/8 in. (9.5mm)	2504.0		ok	23.0	15.44	15.00		
No. 4 (4.75mm)	1468.0		ok	13.5	1.94	2.00	0	10
(J) Pan .....								
(K) Combination Grad. Pan .....								
(L) Loss By T-11.....	119.0							
(M) Final Total ( $\Sigma M_R$ )	10,788.0							

C. F. = (G) ÷ (P)

C. F. = \_\_\_\_\_ ÷ \_\_\_\_\_

C. F. = \_\_\_\_\_ ÷ \_\_\_\_\_

**Sieve Analysis of Fine Aggregate**

Sieve Size	Mass Retained $M_R$		Over Loading	% Retained $(M_R/(H+A)) \times 100$	Percent Passing	Reported Percent Passing	Material Specifications	
	Regular	Combination					Low	High
No. 8 (2.36mm)	31.7		ok	0.3	1.64	2.00	0	5
No. 200 (75µm)	46.2		ok	0.4	1.24	1.20	0	1.5
(N) Pan.....	16.8							
(O) Loss By T-11.....								
(P) Final Total Fine Sample ( $\Sigma M_R$ ).....				119.0				16.8
(Q) Final Total - No. 4 ( $\Sigma M_R$ ).....		94.7		135.8				10884.0
(R) Combined Total (M+Q).....		10882.7		x 100 =	1.24770	%		
(S) Sample Loss or Gain	(A-M) or (M-A).....							
	(H-P) or (P-H).....							
	(A-R) or (R-A).....	1.3						
(T) Percentage of Initial OD Mass ( $(S/A) \times 100$ ) or ( $(S/H) \times 100$ )		0.0						

Name:
Signature:
Date:

Remarks:	<b>Pass</b>	Lab Info Only: <input type="checkbox"/>
----------	-------------	---

Take the information from the table below and complete the calculations for the gradation on the T300 on the next page. Assume that the proper interceptor sieves are the 3/4 in. (19.0 mm) and the 3/8 in. (9.5 mm). Once finished with the calculations, answer the questions below.

Aggregate Type: No. 57 Limestone  
 Initial oven dry weight of total sample: 12,030.4 g  
 Oven dry weight of total sample after T 11: 11,890.1 g

Sieves (mm)	Weight Retained	Sieves (mm)	Weight Retained
1 1/2 in. (37.5 mm)	0.0 g	No. 4 (4.75 mm)	4010.7 g
1 in. (25.0 mm)	396.1 g	No. 8 (2.36 mm)	160.4 g
3/4 in. (19.0 mm)	842.5 g	No. 200 (75 μm)	128.2 g
1/2 in. (12.5 mm)	2920.4 g	Pan	30.4 g
3/8 in. (9.5 mm)	3387.1 g		

- Were the sample results for this gradation valid?  
 If not, what caused the sample results to be invalid?  
 If invalid, what action or actions could have been taken to validate the sample results?
- Did this sample pass specifications?  
 If not, what caused the sample to fail?

Answers can be found on pages 3-38 and 3-39.



**WEST VIRGINIA DIVISION OF HIGHWAYS**  
SIEVE ANALYSIS OF FINE AND COARSE AGGREGATE (AASHTO T-27)  
MATERIALS FINER THAN NO. 200 SIEVE BY WASHING (AASHTO T-11)

Site Manager I.D.#:	Aggregate Size: Sieve Type Coarse:	Spec Sieve Sizes	% Pass	Pass /Fail
Lab Reference Number:	Sieve Type Fine:			
Technician:	Material Type:			
Producer / Supplier Code:	Contract #:			
Producer / Supplier Name:	Project #:			
Site Manager Material Code:	Auth #:			
Date Sampled:	Item #:			
Date Tested:	Tons / CY			

- (A) Initial Oven Dry Mass of Total Sample..... (A) \_\_\_\_\_
- (B) Oven Dry mass of Total Sample After T-11..... (B) \_\_\_\_\_
- (C) Oven Dry Mass of Plus No. 4 Material..... (C) \_\_\_\_\_
- (D) Oven Dry Mass of Plus No. 4 Material After T-11..... (D) \_\_\_\_\_
- (E) Oven Dry Mass of Minus No. 4 Material Used in Split..... (E) \_\_\_\_\_
- (F) Combination Gradation Coarse Fraction Pan Material After Dry Sieving (K)..... (F) \_\_\_\_\_
- (G) Total Oven Dry Mass of Minus No. 4 Material (E+F)..... (G) \_\_\_\_\_
- (H) Initial Oven Dry Mass of Total Fine Sample or Mass of Minus No. 4 Material..... (H) \_\_\_\_\_
- (I) Oven Dry Mass of Total Fine Sample or Mass of Minus No. 4 Material After T-11..... (I) \_\_\_\_\_

**Sieve Analysis of Coarse Aggregate**

Sieve Size	Mass Retained $M_R$		Over Loading	% Retained $(M_R/A) \times 100$	Percent Passing	Reported Percent Passing	Material Specifications	
	Regular	Combination					Low	High
4 in. (100mm)								
1 in. (25mm)								
3/4 in. (19mm)								
1/2 in. (12.5mm)								
3/8 in. (9.5mm)								
No. 4 (4.75mm)								
(J) Pan .....								
(K) Combination Grad. Pan .....								
(L) Loss By T-11 .....								
(M) Final Total ( $\Sigma M_R$ )								

C. F. = (G) + (P)  
C. F. = \_\_\_\_\_ + \_\_\_\_\_  
C. F. = \_\_\_\_\_

**Sieve Analysis of Fine Aggregate**

Sieve Size	Mass Retained $M_R$		Over Loading	% Retained $(M_R/(H+A) \times 100$	Percent Passing	Reported Percent Passing	Material Specifications	
	Regular	Combination					Low	High
No. 8 (2.36mm)								
No. 16 (1.18mm)								
No. 20 (850 $\mu$ m)								
No. 40 (425 $\mu$ m)								
No. 100 (150 $\mu$ m)								
No. 200 (75 $\mu$ m)								
(N) Pan .....								
(O) Loss By T-11 .....								
(P) Final Total Fine Sample ( $\Sigma M_R$ ) .....								
(Q) Final Total - No. 4 ( $\Sigma M_R$ ) .....								
(R) Combined Total (M+Q) .....								
(S) Sample Loss or Gain	(A-M) or (M-A).....							
	(H-P) or (P-H).....							
	(A-R) or (R-A).....							
(T) Percentage of Initial OD Mass ( $(S/A) \times 100$ ) or ( $(S/H) \times 100$ )								

Name: \_\_\_\_\_

Signature: \_\_\_\_\_

Date: \_\_\_\_\_

Remarks:	<b>Pass/Fail</b>	Lab Info Only: <input type="checkbox"/>	

**WEST VIRGINIA DIVISION OF HIGHWAYS**  
SIEVE ANALYSIS OF FINE AND COARSE AGGREGATE (AASHTO T-27)  
MATERIALS FINER THAN NO. 200 SIEVE BY WASHING (AASHTO T-11)

Site Manager I.D.#:	Aggregate Size: Straight User Input	Spec Sieve Sizes	% Pass	Pass /Fail
Lab Reference Number: _____	Sieve Type Coarse: Large Screen Sieve	1-1/2 in. (37.5mm)	100	Pass
Technician: _____	Sieve Type Fine: Large Screen Sieve	1 in. (25mm)	97	Pass
Producer / Supplier Code: _____	Material Type: Lime Stone	1/2 in. (12.5mm)	65	Fail
Producer / Supplier Name: _____	Contract #: _____	No. 4 (4.75mm)	4	Pass
Site Manager Material Code: _____	Project #: _____	No. 8 (2.36mm)	3	Pass
Date Sampled: _____	Auth #: _____	No. 200 (75µm)	1.4	Pass
Date Tested: _____	Item #: _____			
	Tons / CY _____			

- (A) Initial Oven Dry Mass of Total Sample..... (A) 12030.4
- (B) Oven Dry mass of Total Sample After T-11..... (B) 11890.1
- (C) Oven Dry Mass of Plus No. 4 Material..... (C) \_\_\_\_\_
- (D) Oven Dry Mass of Plus No. 4 Material After T-11..... (D) \_\_\_\_\_
- (E) Oven Dry Mass of Minus No. 4 Material Used in Split..... (E) \_\_\_\_\_
- (F) Combination Gradation Coarse Fraction Pan Material After Dry Sieving (K)..... (F) \_\_\_\_\_
- (G) Total Oven Dry Mass of Minus No. 4 Material (E+F)..... (G) \_\_\_\_\_
- (H) Initial Oven Dry Mass of Total Fine Sample or Mass of Minus No. 4 Material..... (H) \_\_\_\_\_
- (I) Oven Dry Mass of Total Fine Sample or Mass of Minus No. 4 Material After T-11..... (I) \_\_\_\_\_

**Sieve Analysis of Coarse Aggregate**

Sieve Size	Mass Retained M <sub>R</sub>		Over Loading	% Retained (M <sub>R</sub> /A)x100	Percent Passing	Reported Percent Passing	Material Specifications	
	Regular	Combination					Low	High
1-1/2 in. (37.5mm)	0.0		ok	0.0	99.91	100.00		100
1 in. (25mm)	396.1		ok	3.3	96.61	97.00	95	100
3/4 in. (19mm)	842.5		ok	7.0	89.61	90.00		
1/2 in. (12.5mm)	2920.4		ok	24.3	65.31	65.00	25	60
3/8 in. (9.5mm)	3387.1		ok	28.2	37.11	37.00		
No. 4 (4.75mm)	4010.7		O/L	33.3	3.81	4.00	0	10

(J) Pan ..... \_\_\_\_\_

(K) Combination Grad. Pan ..... \_\_\_\_\_

(L) Loss By T-11 ..... 140.3

(M) Final Total (Σ M<sub>R</sub>) ..... 11,697.1

C. F. = (G) + (P)

C. F. = \_\_\_\_\_ + \_\_\_\_\_

C. F. = \_\_\_\_\_

**Sieve Analysis of Fine Aggregate**

Sieve Size	Mass Retained M <sub>R</sub>		Over Loading	% Retained (M <sub>R</sub> /(HorA) x100)	Percent Passing	Reported Percent Passing	Material Specifications	
	Regular	Combination					Low	High
No. 8 (2.36mm)	160.4		ok	1.3	2.51	3.00	0	5
No. 200 (75µm)	128.2		ok	1.1	1.41	1.40	0	1.5

(N) Pan ..... 30.4

(O) Loss By T-11 ..... \_\_\_\_\_

(P) Final Total Fine Sample (Σ M<sub>R</sub>) ..... \_\_\_\_\_

(Q) Final Total - No. 4 (Σ M<sub>R</sub>) ..... 319.0

(R) Combined Total (M+Q) ..... 12016.1

(S) Sample Loss or Gain

(A-M) or (M-A) ..... \_\_\_\_\_

(H-P) or (P-H) ..... \_\_\_\_\_

(A-R) or (R-A) ..... 14.3

(T) Percentage of Initial OD Mass ((S/A)x100) or ((S/H)x100) ..... 0.1

Name: \_\_\_\_\_

Signature: \_\_\_\_\_

Date: \_\_\_\_\_

Remarks:	<b>Fail</b>	Lab Info Only: <input type="checkbox"/>
----------	-------------	---

Answers to questions for the example gradation on page 3-36.

1. The gradation was not a valid gradation.

The No. 4 (4.75 mm) sieve was overloaded.

Material retained on the No. 4 (4.75 mm) sieve could have been hand sieved and the material passing could have been subtracted from the weight on the No. 4 (4.75 mm) sieve and added to the weight on the No. 8 (2.36 mm) sieve. The sample could also have been split into increments and then sieved individually and the weights retained on each added together. The initial oven dry weight of sample was about 2,000 g over the minimum 10,000 g. The field sample could also have been split closer to the 10,000g minimum and the sample re-sieved. This may have prevented the overloaded sieves.

2. No.

The 65% passing the 1/2 (12.5 mm) sieve exceeded the specification range of 25% - 60%.

### **PART III**

## **FINE AGGREGATE GRADATIONS**

Performing gradation analysis on fine aggregate samples can be done in a similar fashion to that of coarse aggregate samples. The steps required are the same but have a few differences due mainly to the smaller grain size. The ***difference*** between coarse and fine aggregate samples is that fine aggregates contain particles which ***predominantly*** pass the No. 4 (4.75 mm) sieve and the opposite is true for coarse aggregates. Proceed step by step through the calculations for fine aggregate silica sand for Portland Cement Concrete (PCC). Calculations for this example are to be completed on the T300 worksheet on page 3-47.

#### **Step (ONE) - Sample Preparation:**

First, inspect the **T100**, the document that came with the sample, and determine what the aggregate size and type is, then inspect the field sample. Record the sample lab number, date, and the technician's name on the **T300**. Record the type of material in the "Agg. Type:" space above the "Sieve Analysis of Fine Aggregate" section. In this example silica sand is used.

Next, determine the specification sieves needed. Fine aggregate for PCC is not accepted or evaluated based on a gradation with specified percent passing ranges on certain sieves. It is accepted using a calculated parameter called the  $\bar{A}$  (A bar), to be discussed later. Sieves required for the  $\bar{A}$  calculation are listed in Section 702.1.6 of the specifications and in MP601.03.51. A table listing these sieves can be seen on page 3-80 in Part IV of this chapter. In addition to the  $\bar{A}$ , fine aggregate for PCC will also have a No. 200 (75  $\mu\text{m}$ ) specification in Section 702.1.2 of 0-5.0% for manufactured fine aggregate (limestone sand, sandstone sand, etc.) and 0-3.0% for all other sands (silica sand, etc.). Note that the silica sand example is a river or natural sand and not crushed or manufactured sand. Gradation specification sieves for other various fine aggregates can be found in Section 702 of the Standard Specifications which can be seen in Table 3 of Chapter 1 on page 1-25.

Again, the field sample will be too large to test and will have to be split into a smaller test portion size. Splitting will be conducted as previously described. In paragraph 7.3 of T 27, we find that our test sample size will be a minimum of 300g. Although fine aggregate for PCC does not have required percentages passing each sieve, the gradation should be similar to the fine aggregate alternate grading in Section 702.6 (Table 3, Chapter 1, page 1-25). This grading will be used as a guideline for our fine aggregate specification. With this in mind, it is determined that fine aggregate for PCC is required to have 300g as a minimum test portion. Remember, after splitting, the sample should weigh slightly more than the 300g minimum to compensate for moisture lost during oven drying. The sample should not be split to an exact pre-determined weight; it should be random and close to the approximate minimum.

List the sieves required for the  $\bar{A}$  calculation from page 3-80 in the “Sieve Analysis of Fine Aggregate” area on the T300 worksheet on page 3-47. A completed T300 for this example is on page 3-48 which can be used to check your progress with this example.

After splitting, the sample is then placed in an oven which is maintained at a constant temperature at  $230 \pm 9^{\circ}\text{F}$  ( $110 \pm 5^{\circ}\text{C}$ ) and dried to a constant weight. Once cooled to room temperature, the sample is weighed to the nearest 0.1g, as recommended in Part I of this chapter, and the value entered on Line (H) of our T300 worksheet.

Assume that the oven dry weight of the silica sand example is 340.8 g. Enter this weight in the proper place on the T300 worksheet on Page 3-47. Check to ensure that the weight was entered properly with the T300 on page 3-48.

**Step (Two) - T 11 Wash Test (If Required):**

The T 11 wash test, if there is a requirement for the No. 200 (75  $\mu\text{m}$ ) sieve, should be conducted as described in Part II of this chapter. A No. 200 (75  $\mu\text{m}$ ) sieve is required due to the specifications in Section 702.1.2, requiring a T 11 wash test.

The sample is placed in a suitable container, covered with water containing a sufficient amount of wetting agent and stirred vigorously. The wash water is carefully poured onto the nested sieves, No. 16 (1.18 mm) and No. 200 (75  $\mu\text{m}$ ), taking care not to spill any of the wash water or lose any of the sample.

Answer the following question:

Repeat the above operation until:

- (a) The wash water is clear
- (b) All particles finer than a No. 200 (75  $\mu\text{m}$ ) sieve are removed from the sample
- (c) Both (a) and (b) are accomplished

Answer (c) is correct, we must accomplish both (a) and (b). The washing is continued until all the material finer than the No. 200 (75  $\mu\text{m}$ ) sieve is removed and the wash water runs clear. Once we have met these requirements, all the material retained on the nested sieves is carefully returned to the washed sample. The washed aggregate is then placed in an oven maintained at a constant temperature of  $230 \pm 9^\circ\text{F}$  ( $110 \pm 5^\circ\text{C}$ ) and dried to constant weight. The sample is then cooled and weighed to the nearest 0.1 g. Record this value on Line (I) of the T300 worksheet.

Assume for this example that the weight after drying the sample subjected to the T 11 wash test was 335.5 g. Enter this value in the proper place on the T300 worksheet on page 3-47. When finished check the completed T300 on page 3-48.

The weight loss by T 11 for a fine aggregate is determined by subtracting the value entered on Line (I) from the value entered on Line (H). This difference is entered on Line (O) on the T300 worksheet. This value should also be entered in the "Fine -No. 200 Wet" space of the "Minus No. 200 Calculations" area.

Calculate the loss by T 11 for our example T300 on page 3-47 and enter the result in the proper places. Check your answers on page 3-48.

### **Step (THREE) - Dry Sieving**

Fine aggregate sieving is usually conducted on a small shaker such as a Ro-Tap using 8 in. (203.2 mm) or 12 in. (305.4 mm) sieves. The previously determined specification sieves (Step (ONE)) and any interceptors are now nested in a descending order with the largest sized sieve (ie. sieve with largest square openings) at the top and successively smaller sized sieves below. A lid is placed on the top sieve, a pan is placed at the bottom of the stack, and the stack is placed into the shaker.

The sample is sieved until not more than 0.5% of the original oven dry weight of total sample passes any sieve when hand sieved as previously described on page 3-20.

When the sample has not been sieved adequately, after eliminating the possibility of overloaded sieves (next step), it is necessary to return the sieves to the mechanical shaker and continue the sieving operation for an additional period of time, *preferably not to exceed 10 minutes*. It will be necessary to then re-check one of the sieves, typically the sieve retaining the most material, for sufficiency of sieving. This procedure is described in detail on page 3-20. If sufficiency of sieving is still not achieved, a closer check of procedure and equipment is recommended.

After sieving, the material retained on each sieve is weighed to the nearest 0.1 g as recommended in Part I of this chapter. The values are entered on the line adjacent to the corresponding sieve on the T300 worksheet in the column headed "Mass Retained  $M_R$ " under "Regular".

Enter the values in the table below in the proper places on the T300 on page 3-47 and check your placement on page 3-48.

Sieves	Mass Retained	Sieves	Mass Retained
3/8 in. (9.5 mm)	0.0 g	No. 50 (300 μm)	55.1 g
No. 4 (4.75 mm)	0.0 g	No. 100 (150 μm)	102.8 g
No. 8 (2.36 mm)	10.7 g	No. 200 (75 μm)	68.0 g
No. 16 (1.18 mm)	47.7 g	Pan	3.4 g
No. 30 (600 μm)	47.5 g		

**Step (FOUR) - Sample Loss or Gain and Overloaded Sieves Check:**

Sample loss or gain is calculated as described in Part II. First, the total of all masses retained, pan material and the loss by T11 is calculated and entered on Line (P) of our T300. Next, Line (P) is subtracted from the Line (H) if Line (H) is greater, and vice versa if Line (P) is greater. The result is then recorded on Line (S) in the “(H-P) or (P-H)” space. Although this is a fine aggregate, **it is still extremely rare for the initial and final weights to be exactly the same.** The percentage loss or gain is calculated using the formula on Line (T) and rounded to the nearest 0.1%.

Determine the sample loss or gain percentage for our example on page 3-47 and check your answer on page 3-48.

Turn to the tables on page 3-24 listing the maximum amounts allowed on each sieve. Use the table for the 8 in. (203.2 mm) sieves. Check to see if any sieves were overloaded in our example on page 3-47.

Was this a valid gradation and can we continue in our calculation of the gradation of this sample?

- (a) Yes.                      (b) No.

If not, what action could be taken in order to continue?

**Step (FIVE) - Calculation of Percent Retained:**

We are now ready to calculate the percentage of material retained on each sieve.



Review the calculation described on page 3-3 and 3-26. The percent retained is calculated to the nearest 0.1% for each sieve and for the pan if there is not a No. 200 sieve requirement. These percentages are recorded on the line adjacent to the corresponding sieve in the “% Retained” column.

Calculate the “% Retained” for all sieves in our example on page 3-47 and check your answers on page 3-48.

**Step (SIX) - Calculation of Percent Passing:**

Since standard West Virginia gradation specifications are normally based on the total percent passing a given sieve, the next step in our fine aggregate gradation calculation will be to determine these results and place them in the column headed “Percent Passing”. Review this calculation in Figure 3-2 on page 3-3 and in Part II, Step (SIX) (page 3-27). Remember, if the bottom sieve is a No. 200 (75  $\mu\text{m}$ ) sieve, then the percent of total sample calculated on the bottom line of the “Minus No. 200 Calculations” area is truncated, **not rounded**, to the nearest 0.01% and recorded on the line adjacent to the No. 200 (75  $\mu\text{m}$ ) sieve in the “Percent Passing” column. This percentage is then added to the “% Retained” on the No. 200 (75  $\mu\text{m}$ ) sieve and recorded on the line adjacent to the sieve above the No. 200 (75  $\mu\text{m}$ ) sieve. This is continued until the percent passing is calculated for the top sieve. The “Reported Percent Passing” is to be rounded according to guidelines on pages 3-28 and 3-29.

Calculate the percents passing and the reported percents passing for all the sieves in our example of page 3-47 and check your answers on page 3-48.

**Step (SEVEN) - Evaluation Against Specifications to Determine Pass/Fail:**

Once the calculations are complete the sample is evaluated as passing or failing. In the case of our fine aggregate for PCC example, we would need to complete the  $\bar{A}$  calculation to evaluate the sample. The alternate grading on page 1-25 may be used as a guideline for the specification ranges for fine aggregate for concrete.

After completing all calculations, check your results with the T300 on page 3-48. If there is a difference, check your calculations to find the error.

The steps in conducting a fine aggregate gradation analysis can be summarized as follows:

- Step ONE** -           **Sample Preparation**
- Step TWO** -           **T 11 Wash Test (If Required)**
- Step THREE** -       **Dry Sieving**
- Step FOUR** -       **Sample Loss or Gain and Overloaded Sieves Check**
- Step FIVE** -       **Calculation of Percent Retained**
- Step SIX** -           **Calculation of Percent Passing**
- Step SEVEN** -      **Evaluation Against Specifications**

Continue working the additional practice fine aggregate gradation problems on pages 3-49 and 3-55.

**WEST VIRGINIA DIVISION OF HIGHWAYS**  
**SIEVE ANALYSIS OF FINE AND COARSE AGGREGATE (AASHTO T-27)**  
**MATERIALS FINER THAN No. 200 SIEVE BY WASHING (AASHTO T-11)**

[Click To Begin](#)

Site Manager I.D.#:  Lab Reference Number: Technician: Producer / Supplier Code: Producer / Supplier Name: Site Manager Material Code: Date Sampled: Date Tested:	Aggregate Size: Class 1 Sieve Type Coarse: 12 Inch Sieve Type Fine: 12 Inch Material Type: Lime Stone Contract #: Project #: Auth #: Item #: Tons / CY	<table border="1" style="width: 100%; border-collapse: collapse;"> <tr> <th style="width: 15%;">Spec Sieve Sizes</th> <th style="width: 15%;">% Pass</th> <th style="width: 15%;">Pass</th> <th style="width: 15%;">Fail</th> </tr> <tr><td> </td><td> </td><td> </td><td> </td></tr> <tr><td> </td><td> </td><td> </td><td> </td></tr> <tr><td> </td><td> </td><td> </td><td> </td></tr> <tr><td> </td><td> </td><td> </td><td> </td></tr> <tr><td> </td><td> </td><td> </td><td> </td></tr> <tr><td> </td><td> </td><td> </td><td> </td></tr> <tr><td> </td><td> </td><td> </td><td> </td></tr> </table>	Spec Sieve Sizes	% Pass	Pass	Fail																												
Spec Sieve Sizes	% Pass	Pass	Fail																															

- (A) Initial Oven Dry Mass of Total Sample ..... (A) \_\_\_\_\_
- (B) Oven Dry mass of Total Sample After T-11 ..... (B) \_\_\_\_\_
- (C) Oven Dry Mass of Plus No. 4 Material ..... (C) \_\_\_\_\_
- (D) Oven Dry Mass of Plus No. 4 Material After T-11 ..... (D) \_\_\_\_\_
- (E) Oven Dry Mass of Minus No. 4 Material Used in Split ..... (E) \_\_\_\_\_
- (F) Combination Gradation Coarse Fraction Pan Material After Dry Sieving (K) ..... (F) \_\_\_\_\_
- (G) Total Oven Dry Mass of Minus No. 4 Material (E+F) ..... (G) \_\_\_\_\_
- (H) Initial Oven Dry Mass of Total Fine Sample or Mass of Minus No. 4 Material ..... (H) \_\_\_\_\_
- (I) Oven Dry Mass of Total Fine Sample or Mass of Minus No. 4 Material After T-11 ..... (I) \_\_\_\_\_

**Sieve Analysis of Coarse Aggregate**

Sieve Size	Mass Retained M <sub>R</sub>		Over Loading	% Retained (M <sub>R</sub> /A)x100	Percent Passing	Reported Percent Passing	Material Specifications	
	Regular	Combination					Low	High
(J) Pan								
(K) Combination Grad. Pan								
(L) Loss By T-11								
(M) Final Total (Σ M <sub>R</sub> )								

C. F. = (G) ÷ (P)  
 C. F. = \_\_\_\_\_ ÷ \_\_\_\_\_  
 C. F. = \_\_\_\_\_

**Sieve Analysis of Fine Aggregate**

Sieve Size	Mass Retained M <sub>R</sub>		Over Loading	% Retained (M <sub>R</sub> /(H+A)x100)	Percent Passing	Reported Percent Passing	Material Specifications	
	Regular	Combination					Low	High
(N) Pan								
(O) Loss By T-11								
(P) Final Total Fine Sample (Σ M <sub>R</sub> )								
(Q) Final Total - No. 4 (Σ M <sub>R</sub> )								
(R) Combined Total (M+Q)								
(S) Sample Loss or Gain								
(T) Percentage of Initial OD Mass ((S/A)x100) or ((S/H)x100)								

Name:	
Signature:	
Date:	

Remarks:	<b>Pass/Fail</b>	Lab Info Only:
----------	------------------	----------------

**WEST VIRGINIA DIVISION OF HIGHWAYS**  
SIEVE ANALYSIS OF FINE AND COARSE AGGREGATE (AASHTO T-27)  
MATERIALS FINER THAN No. 200 SIEVE BY WASHING (AASHTO T-11)

Click To Begin

Site Manager I.D.#:	Aggregate Size: Class 1	Spec Sieve Sizes	%	Pass /Fail
Lab Reference Number:	Sieve Type Coarse: 12 Inch	3/8in. (9.5mm)	100	Pass
Technician:	Sieve Type Fine: 12 Inch	No. 4 (4.75mm)	100	Pass
Producer / Supplier Code:	Material Type: Lime Stone	No. 16 (1.18mm)	83	Fail
Producer / Supplier Name:	Contract #:	No. 50 (300µm)	53	Fail
Site Manager Material Code:	Project #:	No. 100 (150µm)	23	Fail
Date Sampled:	Auth #:	No. 200 (75µm)	2.6	Pass
Date Tested:	Item #:			
	Tons / CY			

- (A) Initial Oven Dry Mass of Total ..... (A) \_\_\_\_\_
- (B) Oven Dry mass of Total Sample After T-11..... (B) \_\_\_\_\_
- (C) Oven Dry Mass of Plus No. 4 Material..... (C) \_\_\_\_\_
- (D) Oven Dry Mass of Plus No. 4 Material After T-11..... (D) \_\_\_\_\_
- (E) Oven Dry Mass of Minus No. 4 Material Used in Split..... (E) \_\_\_\_\_
- (F) Combination Gradation Coarse Fraction Pan Material After Dry Sieving (K)..... (F) \_\_\_\_\_
- (G) Total Oven Dry Mass of Minus No. 4 Material (E+F)..... (G) \_\_\_\_\_
- (H) Initial Oven Dry Mass of Total Fine Sample or Mass of Minus No. 4 Material.. (H) 340.8
- (I) Oven Dry Mass of Total Fine Sample or Mass of Minus No. 4 Material After T-1..... (I) 335.5

**Sieve Analysis of Coarse Aggregate**

Sieve Size	Mass Retained M <sub>R</sub>		Over Loading	% Retained (M <sub>R</sub> /A)x100	Percent Passing	Reported Percent Passing	Material Specifications	
	Regular	Combination					Low	High

- (J) Pan ..... (J) \_\_\_\_\_
- (K) Combination Grad. Pan ..... (K) \_\_\_\_\_
- (L) Loss By T-11..... (L) \_\_\_\_\_
- (M) Final Total (Σ M<sub>R</sub>)..... (M) \_\_\_\_\_
- C. F. =   (G)   ÷   (P)    
C. F. = \_\_\_\_\_ ÷   340.5    
C. F. = \_\_\_\_\_

**Sieve Analysis of Fine Aggregate**

Sieve Size	Mass Retained M <sub>R</sub>		Over Loading	% Retained (M <sub>R</sub> /(H+R))x100	Percent Passing	Reported Percent Passing	Material Specifications	
	Regular	Combination					Low	High
3/8in. (9.5mm)	0.0		ok	0.0	99.95	100		100
No. 4 (4.75mm)	0.0		ok	0.0	99.95	100	95	100
No. 8 (2.36mm)	10.7		ok	3.1	96.85	97		
No. 16 (1.18mm)	47.7		ok	14.0	82.85	83	45	80
No. 30 (600µm)	47.5		ok	13.9	68.95	69		
No. 50 (300µm)	55.1		ok	16.2	52.75	53	10	30
No. 100 (150µm)	102.8		ok	30.2	22.55	23	2	10
No. 200 (75µm)	68.0		ok	20.0	2.55	2.6	0	3

- (N) Pan..... (N)   3.4
- (O) Loss By T-11..... (O)   5.3   Coarse - No. 200 Dry Fine - No. 200 Dry   3.4
- (P) Final Total Fine Sample (Σ M<sub>R</sub>)..... (P)   340.5   Coarse - No. 200 Wet Fine - No. 200 Wet   5.3
- (Q) Final Total - No. 4 (Σ M<sub>R</sub>)..... (Q)   340.5   Total - No. 200   8.7   ÷ Init. Mass (A) or (H)   340.8
- (R) Combined Total (M+Q)..... (R)   340.5   x 100 =   2.55281   %
- (S) Sample Loss or Gain  
 (A-M) or (M-A).....  
 (H-P) or (P-H).....   0.3    
 (A-R) or (R-A).....
- (T) Percentage of Initial OD Mass ((S/A)x100) or ((S/H)x100)   0.1

Name:
Signature:
Date:

Remarks:	<b>Fail</b>	Lab Info Only: <input type="checkbox"/>
----------	-------------	---

**Exercise 2: Fine Gradation:**

Complete the following steps to familiarize yourself with the calculations for a Fine gradation. We will be using silica sand for PCC in this example. Use the blank T300 sheet on page 3-53. A completed T300 can be seen on page 3-54.

1. Fill in the identification information about the sample.
  - a. Information at the top of the T300.
    - Field Sample #, Tech. and Lab, and Date.
  - b. Aggregate Type just above the “Sieve Analysis of Fine Aggregate” section of the T300.
    - In this case (silica sand).

**Necessary Sieves and Specification Determination:**

2. Determine the necessary sieves and enter them on the T300.
  - a. The gradation for this silica sand will include the  $\bar{A}$  sieves listed on page 3-80. Aggregate for concrete must meet an additional specification for the No. 200 sieve which can be found in Section 702.1.2 of the spec book.
  - b. Enter the sieves, starting with the largest sieve first, in the “Sieve Size” column of the “Sieve Analysis of Fine Aggregate” section on the T300.
  - c. Enter the ranges for percent passing for each specification sieve in the “Material Spec’s” column adjacent to the corresponding sieve. (Used only as a guideline for  $\bar{A}$ )

**Sample Preparation, T 11 Wash Test, and Dry Sieving:**

3. Weights determined during each part of testing can be seen in the table below.

Initial O. D. weight	356.1 g	No. 30 (600 $\mu\text{m}$ )	85.3 g
O. D. weight after T 11	345.1 g	No. 50 (300 $\mu\text{m}$ )	53.7 g
3/8 (9.50 mm)	0.0 g	No. 100 (150 $\mu\text{m}$ )	37.1 g
No. 4 (4.75 mm)	10.7 g	No. 200 (75 $\mu\text{m}$ )	33.0 g
No. 8 (2.36 mm)	27.0 g	Pan	4.3 g
No. 16 (1.18 mm)	92.5 g		

- a. Record the initial oven dry weight of the sample on Line (H) of the T300.
- b. Record the oven dry weight of the sample after T 11 on Line (I) of the T300.
- c. Record the weights retained in the “Regular” side of the “Mass Retained  $M_R$ ” column on the T300 next to the corresponding sieve.
- d. Record the mass retained in the pan on line (N) of the T300.
- e. Also record this value in the “Fine -No. 200 Dry” space in the “Minus No. 200 Calculations” area in the lower right of the T300.

4. Determine the weight loss from T 11.
  - a. Subtract the weight after T 11 on Line (I) from the initial weight on Line (H).
  - b. Record this difference on Line (O) on the T300.
  - c. Also record this value in the “Fine -No. 200 Wet” space in the “Minus No. 200 Calculations” area in the lower right of the T300.

**Overloaded Sieves and Sample Loss or Gain Check:**

5. Check for overloaded sieves.
  - a. Check the masses retained on all the sieves with the maximum limits allowed as listed on page 3-24.
  - b. Indicate if the sieves are overloaded on the T300 with an asterisk next to the mass retained.
6. Calculate the percentage loss or gain.
  - a. Add all the masses retained and record this value on Line (P) of the T300.
  - b. Either subtract Line (P) from Line (H) or Line (H) from Line (P) depending on which is greater. Record this result on Line (S) in the “(H-P) or (P-H)” space.
  - c. Determine the percentage loss by using the  $((S/H) \times 100)$  formula and record the answer to the nearest 0.1% on Line (T).

**Percent Retained Calculation:**

7. Calculate the percent retained on each sieve.
  - a. Divide the mass retained on each sieve by the Initial Oven Dry Mass of Total Fine Sample (line (H)) and record the results in the “Percent Retained  $M_R/A \times 100$ ” column on the T300 next to the corresponding sieve.
    - Use the formula below and round values to the nearest 0.1%.

$$\text{Percent Retained} = \frac{\text{Mass Retained}}{\text{Initial Oven Dry Mass of Total Sample}} \times 100$$

**Percent Passing Calculation:**

8. Calculate the Percent Passing the No. 200 (75  $\mu\text{m}$ ) sieve in the “Minus No. 200 Calculations” area in the lower right of the T300.

- a. Add the "Fine -No. 200 Dry" and "Fine -No.200 Wet" values and record the total in the "Total -No. 200" space.
  - b. Record the initial oven dry mass in "÷ Init. Mass (A) or (H)".
  - c. Divide the "Total -No. 200" weight by the initial oven dry weight and multiply by 100.
  - d. Record this percentage on the bottom line of the "Minus No. 200 Calculations" area. Carry out to about 5 decimal places (**Do not round this number**).
9. Calculate the percent passing each sieve.
- a. Move the percent passing the No. 200 (75  $\mu\text{m}$ ) sieve up to the "Percent Passing" column on the line adjacent to the No. 200 (75  $\mu\text{m}$ ) sieve.
    - Cut this number off to two decimal places. **Do not round this number.**
  - b. Add the percent passing the No. 200 (75  $\mu\text{m}$ ) sieve, cut off to two decimal places (**not rounded**), to the percent retained on the No. 200 (75  $\mu\text{m}$ ) sieve and record the result in the "Percent Passing" column on the No. 100 (150  $\mu\text{m}$ ) sieve line.
  - c. Repeat step (b) for all remaining sieves used. Record the results to two decimal places.
10. Round the percent passing each sieve for reporting.
- a. Round the percent passing the No. 200 (75  $\mu\text{m}$ ) sieve to the nearest 0.1%.
  - b. Round the percent passing each sieve above the No. 200 (75  $\mu\text{m}$ ) sieve to the nearest 1% and record these values in the "Reported Percent Passing" column on the T300.

**Sample Evaluation:**

11. Evaluate the sample for specification compliance. Remember that fine aggregate for  $\bar{A}$  is not evaluated using the alternate grading, so no action is required here. If it were evaluated would it pass or fail?
12. Indicate passing or failing. (Only for this exercise,  $\bar{A}$  gradation does not actually pass or fail).
  - a. Record the "Reported Percent Passing" for the specification sieves in the spaces

labeled “1st”, “2nd”, etc. at the top of the T300.

- The percent passing the largest specification sieve will be listed in the “1st” space and the smallest sieve will be in the highest consecutive numbered space.
- The percent passing the No. 200 (75  $\mu\text{m}$ ) sieve will always be listed in the “No. 200” space if the specifications require it.



**WEST VIRGINIA DIVISION OF HIGHWAYS**  
**SIEVE ANALYSIS OF FINE AND COARSE AGGREGATE (AASHTO T-27)**

Click To Begin

T300E  
 Rev 2017-06-23

**MATERIALS FINER THAN No. 200 SIEVE BY WASHING (AASHTO T-11)**

Site Manager I.D.#:	Aggregate Size: Class 1	Spec Sieve Sizes	% Pass	Pass /Fail
Lab Reference Number:	Sieve Type Coarse: 12 Inch			
Technician:	Sieve Type Fine: 12 Inch			
Producer / Supplier Code:	Material Type: Lime Stone			
Producer / Supplier Name:	Contract #:			
Site Manager Material Code:	Project #:			
Date Sampled:	Auth #:			
Date Tested:	Item #:			
	Tons / CY			

- (A) Initial Oven Dry Mass of Total Sample..... (A) \_\_\_\_\_
- (B) Oven Dry mass of Total Sample After T-11..... (B) \_\_\_\_\_
- (C) Oven Dry Mass of Plus No. 4 Material..... (C) \_\_\_\_\_
- (D) Oven Dry Mass of Plus No. 4 Material After T-11 ..... (D) \_\_\_\_\_
- (E) Oven Dry Mass of Minus No. 4 Material Used in Split..... (E) \_\_\_\_\_
- (F) Combination Gradation Coarse Fraction Pan Material After Dry Sieving (K) ..... (F) \_\_\_\_\_
- (G) Total Oven Dry Mass of Minus No. 4 Material (E+F)..... (G) \_\_\_\_\_
- (H) Initial Oven Dry Mass of Total Fine Sample or Mass of Minus No. 4 Material..... (H) \_\_\_\_\_
- (I) Oven Dry Mass of Total Fine Sample or Mass of Minus No. 4 Material After T-11..... (I) \_\_\_\_\_

**Sieve Analysis of Coarse Aggregate**

Sieve Size	Mass Retained $M_R$		Over Loading	% Retained $(M_R/A) \times 100$	Percent Passing	Reported Percent Passing	Material Specifications	
	Regular	Combination					Low	High

- (J) Pan .....
  - (K) Combination Grad. Pan .....
  - (L) Loss By T-11.....
  - (M) Final Total ( $\Sigma M_R$ ).....
- C. F. = (G) ÷ (P)  
 C. F. = ÷  
 C. F. =

**Sieve Analysis of Fine Aggregate**

Sieve Size	Mass Retained $M_R$		Over Loading	% Retained $(M_R/(H+R)) \times 100$	Percent Passing	Reported Percent Passing	Material Specifications	
	Regular	Combination					Low	High

- (N) Pan.....
  - (O) Loss By T-11.....
  - (P) Final Total Fine Sample ( $\Sigma M_R$ ).....
  - (Q) Final Total - No. 4 ( $\Sigma M_R$ ).....
  - (R) Combined Total (M+Q).....
  - (S) Sample Loss or Gain  
 (A-M) or (M-A).....  
 (H-P) or (P-H).....  
 (A-R) or (R-A).....
  - (T) Percentage of Initial OD Mass ( $(S/A) \times 100$ ) or  $((S/H) \times 100)$
- Coarse - No. 200 Dry  
 Coarse - No. 200 Wet  
 Total - No. 200  
 ÷ Init. Mass (A) or (H)  
 x 100 = %

Name:	
Signature:	
Date:	

Remarks:	<b>Pass/Fail</b>	Lab Info Only:
----------	------------------	----------------

**WEST VIRGINIA DIVISION OF HIGHWAYS**  
**SIEVE ANALYSIS OF FINE AND COARSE AGGREGATE (AASHTO T-27)**

[Click To Begin](#)

T300E  
 Rev 2017-06-23

**MATERIALS FINER THAN No. 200 SIEVE BY WASHING (AASHTO T-11)**

<b>Site Manager I.D.#:</b>	<b>Aggregate Size:</b> Class 1	<b>Spec Sieve</b>	<b>%</b>	<b>Pass</b>
<b>Lab Reference Number:</b>	<b>Sieve Type Coarse:</b> 12 Inch	<b>Sizes</b>	<b>Pass</b>	<b>/Fail</b>
<b>Technician:</b>	<b>Sieve Type Fine:</b> 12 Inch	3/8in. (9.5mm)	100	Pass
<b>Producer / Supplier Code:</b>	<b>Material Type:</b> Lime Stone	No. 4 (4.75mm)	97	Pass
<b>Producer / Supplier Name:</b>	<b>Contract #:</b>	No. 16 (1.18mm)	63	Pass
<b>Site Manager Material Code:</b>	<b>Project #:</b>	No. 50 (300µm)	24	Pass
<b>Date Sampled:</b>	<b>Auth #:</b>	No. 100 (150µm)	14	Fail
<b>Date Tested:</b>	<b>Item #:</b>	No. 200 (75µm)	4.3	Fail
	<b>Tons / CY</b>			

- (A) Initial Oven Dry Mass of Total Sample ..... (A) \_\_\_\_\_
- (B) Oven Dry mass of Total Sample After T-11..... (B) \_\_\_\_\_
- (C) Oven Dry Mass of Plus No. 4 Material ..... (C) \_\_\_\_\_
- (D) Oven Dry Mass of Plus No. 4 Material After T-11..... (D) \_\_\_\_\_
- (E) Oven Dry Mass of Minus No. 4 Material Used in Split ..... (E) \_\_\_\_\_
- (F) Combination Gradation Coarse Fraction Pan Material After Dry Sieving (K) ..... (F) \_\_\_\_\_
- (G) Total Oven Dry Mass of Minus No. 4 Material (E+F) ..... (G) \_\_\_\_\_
- (H) Initial Oven Dry Mass of Total Fine Sample or Mass of Minus No. 4 Material ..... (H) 356.1
- (I) Oven Dry Mass of Total Fine Sample or Mass of Minus No. 4 Material After T-11 ..... (I) 345.1

**Sieve Analysis of Coarse Aggregate**

Sieve Size	Mass Retained M <sub>R</sub>		Over Loading	% Retained (M <sub>R</sub> /A)x100	Percent Passing	Reported Percent Passing	Material Specifications	
	Regular	Combination					Low	High
(J) Pan								
(K) Combination Grad. Pan								
(L) Loss By T-11								
(M) Final Total (Σ M <sub>R</sub> )								

C. F. = (G) ÷ (P)  
 C. F. = \_\_\_\_\_ ÷ 354.6  
 C. F. = \_\_\_\_\_

**Sieve Analysis of Fine Aggregate**

Sieve Size	Mass Retained M <sub>R</sub>		Over Loading	% Retained (M <sub>R</sub> /HorA)x100	Percent Passing	Reported Percent Passing	Material Specifications	
	Regular	Combination					Low	High
3/8in. (9.5mm)	0.0		ok	0.0	99.69	100		100
No. 4 (4.75mm)	10.7		ok	3.0	96.69	97	95	100
No. 8 (2.36mm)	27.0		ok	7.6	89.09	89		
No. 16 (1.18mm)	92.5		ok	26.0	63.09	63	45	80
No. 30 (600µm)	85.3		ok	24.0	39.09	39		
No. 50 (300µm)	53.7		ok	15.1	23.99	24	10	30
No. 100 (150µm)	37.1		ok	10.4	13.59	14	2	10
No. 200 (75µm)	33.0		ok	9.3	4.29	4.3	0	3
(N) Pan	4.3							
(O) Loss By T-11	11.000							
(P) Final Total Fine Sample (Σ M <sub>R</sub> )	354.6							
(Q) Final Total - No. 4 (Σ M <sub>R</sub> )								
(R) Combined Total (M+Q)								
(S) Sample Loss or Gain								
(T) Percentage of Initial OD Mass ((S/A)x100) or ((S/H)x100)								

O/L  
 Coarse - No. 200 Dry  
 Fine - No. 200 Dry  
 Coarse - No. 200 Wet  
 Fine - No. 200 Wet  
 Total - No. 200  
 15.3 ÷ Init. Mass (A) or (H)  
 x 100 = 4.29654 %  
 (A-M) or (M-A)  
 (H-P) or (P-H)  
 (A-R) or (R-A)  
 1.5  
 0.4 To much weight Loss

Name: \_\_\_\_\_

Signature: \_\_\_\_\_

Date: \_\_\_\_\_

<b>Remarks:</b>	<b>Fail</b>	<b>Lab Info Only:</b>
-----------------	-------------	-----------------------

Complete the fine aggregate gradation using the T 100 on page 56 using the following information. Completed T 100 on page 57. Once finished with the calculations, answer the questions below.

Aggregate Type: Manufactured Sand for PCC  
 Initial oven dry mass of fine sample: 320.6 g  
 Oven dry mass of fine sample after T 11: 310.3 g

Sieves (mm)	Mass Retained	Sieves (mm)	Mass Retained
3/8 in. (9.5 mm)	0.0 g	No. 50 (300 μm)	103.9 g
No. 4 (4.75 mm)	15.8 g	No. 100 (150 μm)	10.5 g
No. 8 (2.36 mm)	47.3 g	No. 200 (75 μm)	20.0 g
No. 16 (1.18 mm)	60.2 g	Pan	2.1 g
No. 30 (600 μm)	50.3 g		

1) Were the sample results for this gradation valid?

If not, what caused the sample results to be invalid?

If invalid, what action or actions could have been taken to validate the sample results?

**WEST VIRGINIA DIVISION OF HIGHWAYS**  
**SIEVE ANALYSIS OF FINE AND COARSE AGGREGATE (AASHTO T-27)**

Click To Begin

T300E  
 Rev 2017-06-23

**MATERIALS FINER THAN No. 200 SIEVE BY WASHING (AASHTO T-11)**

Site Manager I.D.#:	Aggregate Size: Class 1	Spec Sieve Sizes	% Pass	Pass /Fail
Lab Reference Number:	Sieve Type Coarse: 12 Inch			
Technician:	Sieve Type Fine: 12 Inch			
Producer / Supplier Code:	Material Type: Lime Stone			
Producer / Supplier Name:	Contract #:			
Site Manager Material Code:	Project #:			
Date Sampled:	Auth #:			
Date Tested:	Item #:			
	Tons / CY			

- (A) Initial Oven Dry Mass of Total Sample ..... (A) \_\_\_\_\_
- (B) Oven Dry mass of Total Sample After T-11 ..... (B) \_\_\_\_\_
- (C) Oven Dry Mass of Plus No. 4 Material ..... (C) \_\_\_\_\_
- (D) Oven Dry Mass of Plus No. 4 Material After T-11 ..... (D) \_\_\_\_\_
- (E) Oven Dry Mass of Minus No. 4 Material Used in Split ..... (E) \_\_\_\_\_
- (F) Combination Gradation Coarse Fraction Pan Material After Dry Sieving (K) ..... (F) \_\_\_\_\_
- (G) Total Oven Dry Mass of Minus No. 4 Material (E+F) ..... (G) \_\_\_\_\_
- (H) Initial Oven Dry Mass of Total Fine Sample or Mass of Minus No. 4 Material ..... (H) \_\_\_\_\_
- (I) Oven Dry Mass of Total Fine Sample or Mass of Minus No. 4 Material After T-11 ..... (I) \_\_\_\_\_

**Sieve Analysis of Coarse Aggregate**

Sieve Size	Mass Retained $M_R$		Over Loading	% Retained $(M_R/A) \times 100$	Percent Passing	Reported Percent Passing	Material Specifications	
	Regular	Combination					Low	High
(J) Pan								
(K) Combination Grad. Pan								
(L) Loss By T-11								
(M) Final Total ( $\Sigma M_R$ )								

C. F. = (G) ÷ (P)  
 C. F. = \_\_\_\_\_ ÷ \_\_\_\_\_  
 C. F. = \_\_\_\_\_

**Sieve Analysis of Fine Aggregate**

Sieve Size	Mass Retained $M_R$		Over Loading	% Retained $(M_R/(H \times A)) \times 100$	Percent Passing	Reported Percent Passing	Material Specifications	
	Regular	Combination					Low	High
(N) Pan								
(O) Loss By T-11								
(P) Final Total Fine Sample ( $\Sigma M_R$ )								
(Q) Final Total - No. 4 ( $\Sigma M_R$ )								
(R) Combined Total (M+Q)								
(S) Sample Loss or Gain	(A-M) or (M-A)	(H-P) or (P-H)	(A-R) or (R-A)					
(T) Percentage of Initial OD Mass ( $(S/A) \times 100$ ) or ( $(S/H) \times 100$ )								

Coarse - No. 200 Dry      Fine - No. 200 Dry  
 Coarse - No. 200 Wet      Fine - No. 200 Wet  
 Total - No. 200      ÷ Init. Mass (A) or (H)  
 x 100 = \_\_\_\_\_ %

Name: \_\_\_\_\_

Signature: \_\_\_\_\_

Date: \_\_\_\_\_

Remarks:	<b>Pass/Fail</b>	Lab Info Only:
----------	------------------	----------------

**WEST VIRGINIA DIVISION OF HIGHWAYS**  
**SIEVE ANALYSIS OF FINE AND COARSE AGGREGATE (AASHTO T-27)**

Click To Begin

T300E  
 Rev 2017-06-23

**MATERIALS FINER THAN No. 200 SIEVE BY WASHING (AASHTO T-11)**

Site Manager I.D.#:	Aggregate Size: Class 1	Spec Sieve Sizes	% Pass	Pass /Fail
Lab Reference Number:	Sieve Type Coarse: 12 Inch	3/8in. (9.5mm)	100	Pass
Technician:	Sieve Type Fine: 12 Inch	No. 4 (4.75mm)	95	Pass
Producer / Supplier Code:	Material Type: Lime Stone	No. 16 (1.18mm)	61	Pass
Producer / Supplier Name:	Contract #:	No. 50 (300µm)	13	Pass
Site Manager Material Code:	Project #:	No. 100 (150µm)	10	Pass
Date Sampled:	Auth #:	No. 200 (75µm)	3.9	Fail
Date Tested:	Item #:			
	Tons / CY			

- (A) Initial Oven Dry Mass of Total Sample.....(A)
- (B) Oven Dry mass of Total Sample After T-11.....(B)
- (C) Oven Dry Mass of Plus No. 4 Material.....(C)
- (D) Oven Dry Mass of Plus No. 4 Material After T-11.....(D)
- (E) Oven Dry Mass of Minus No. 4 Material Used in Split.....(E)
- (F) Combination Gradation Coarse Fraction Pan Material After Dry Sieving (K).....(F)
- (G) Total Oven Dry Mass of Minus No. 4 Material (E+F).....(G)
- (H) Initial Oven Dry Mass of Total Fine Sample or Mass of Minus No. 4 Material.....(H) 320.6
- (I) Oven Dry Mass of Total Fine Sample or Mass of Minus No. 4 Material After T-11.....(I) 310.3

**Sieve Analysis of Coarse Aggregate**

Sieve Size	Mass Retained M <sub>R</sub>		Over Loading	% Retained (M <sub>R</sub> /A)x100	Percent Passing	Reported Percent Passing	Material Specifications	
	Regular	Combination					Low	High

- (J) Pan .....
  - (K) Combination Grad. Pan .....
  - (L) Loss By T-11.....
  - (M) Final Total (Σ M<sub>R</sub>)
- C. F. = (G) ÷ (P)  
 C. F. = \_\_\_\_\_ ÷ 320.4  
 C. F. = \_\_\_\_\_

**Sieve Analysis of Fine Aggregate**

Sieve Size	Mass Retained M <sub>R</sub>		Over Loading	% Retained (M <sub>R</sub> /HorA) x100	Percent Passing	Reported Percent Passing	Material Specifications	
	Regular	Combination					Low	High
3/8in. (9.5mm)	0.0		ok	0.0	99.96	100		100
No. 4 (4.75mm)	15.8		ok	4.9	95.06	95	95	100
No. 8 (2.36mm)	47.3		ok	14.8	80.26	80		
No. 16 (1.18mm)	60.2		ok	18.8	61.46	61	45	80
No. 30 (600µm)	50.3		ok	15.7	45.76	46		
No. 50 (300µm)	103.9		ok	32.4	13.36	13	10	30
No. 100 (150µm)	10.5		ok	3.3	10.06	10	2	10
No. 200 (75µm)	20.0		ok	6.2	3.86	3.9	0	3

- (N) Pan..... 2.1
  - (O) Loss By T-11..... 10.3
  - (P) Final Total Fine Sample (Σ M<sub>R</sub>)..... 320.4
  - (Q) Final Total - No. 4 (Σ M<sub>R</sub>).....
  - (R) Combined Total (M+Q).....
  - (S) Sample Loss or Gain
  - (T) Percentage of Initial OD Mass ((S/A)x100) or ((S/H)x100)..... 0.1
- O/L  
 Coarse - No. 200 Dry  
 Fine - No. 200 Dry  
 Coarse - No. 200 Wet  
 Fine - No. 200 Wet  
 Total - No. 200  
 12.4 ÷ Init. Mass (A) or (H)  
 320.6  
 x 100 = 3.86774 %

Name: \_\_\_\_\_  
 Signature: \_\_\_\_\_  
 Date: \_\_\_\_\_

Remarks: **Fail** Lab Info Only:

## **PART IV**

### **SIEVE ANALYSIS OF MATERIAL CONTAINING A COMBINATION OF COARSE AND FINE AGGREGATE**

Some aggregate types are a combination of both coarse, plus No. 4 (4.75 mm) and fine, minus No. 4 (4.75 mm) particles. The applied concept is that voids between the larger particles will be filled with smaller particles resulting in a mixture that has a lot of particle point to point contacts, or is keyed together. This results in a high-density mixture of aggregate particles which will compact well. This dense compacted mix is a good base on which to construct a structure or pavement. Aggregates for shoulder material are also produced with a combination of sizes for good compaction. However, they are generally designed with less fine aggregate to facilitate drainage of water from the roadway.

There are several types of combination aggregates, but they are all tested in the same manner. The fact that there is a combination of coarse and fine particles suggests a need for both a coarse gradation and a fine gradation to be run on a single sample. It is not feasible to test a combination gradation sample using only a large mechanical shaker, for coarse aggregate, and not practical to test it with only a Rotap [8 in. sieve (203.2 mm)] shaker, for fine aggregate. Therefore, combination gradation samples must be split into coarse and fine portions, or fractions, prior to conducting the actual sieve analysis. All the steps described in Parts I and II are still necessary for combination aggregate gradations but there are a few additional steps. The calculations for combination gradations are also different. We will again use an example gradation for a combination aggregate, in this case a Class 1 Limestone for Base Course, to illustrate the steps required for a combination gradation. Calculations for this example problem will be completed on the T300 on page 3-68. A completed copy of this gradation can be found on page 3-69.

### **Step (ONE) - Sample Preparation:**

Begin with a field sample taken in accordance to sampling procedures.

Paragraph 7.1 of T27 states that the field sample should be **four times** the weight required for the gradation test **or** the weight in stated in ASTM D75, whichever is greater. Sampling in West Virginia requires the use of field sample sizes indicated in MP700.00.06 which are designed to meet the requirements of T27 and are the same as in D75. Field and test sample sizes for coarse and fine aggregate mixtures are the same as for coarse aggregates with the corresponding nominal maximum size.

Begin the test by entering the proper identification information for the sample and the technician as well as the date tested on the T300. Next, record the type of aggregate and the necessary sieves and specifications for the aggregate being tested. Since this is a combination gradation, the No. 4 (4.75 mm) and larger sieves will be listed in the coarse aggregate sieve analysis section and smaller sieves will be listed in the fine aggregate section. Specifications for combination aggregates can be found in Section 704 of the West Virginia Standard Specifications. Combination aggregates for different purposes have been given different Class designations (Class 1 through 10) which are specified in Table 704.6.2A in the spec book and reproduced as Table 2 (Chap. 1, page 1-24) of this manual.

For this example, assume that the 1 in. (25.0 mm), 1/2 in. (12.5 mm), and 3/8 in. (9.5 mm) sieves will be necessary interceptors for the coarse aggregate fraction and the No. 8 (2.36 mm), No. 16 (1.18 mm), No. 50 (300  $\mu$ m), and No. 100 (150  $\mu$ m) sieves will be necessary interceptor sieves for the fine fraction. List the sieves and specifications for the Class 1 limestone on the T300 on page 3-68. Check your placement with the copy on page 3-69.

As before, the field sample is too large to test and needs to be reduced to be tested. There are three stages of splitting for a combination gradation sample. These splitting procedures are illustrated in *Figure 3.3*. First, the field sample is split to a test portion

size. The test portion is then split into coarse and fine aggregate fractions. The fine aggregate fraction is then split into a convenient testing size. For the combination aggregate there will be two test portions dry sieved for the same sample; a coarse fraction and a fine fraction.

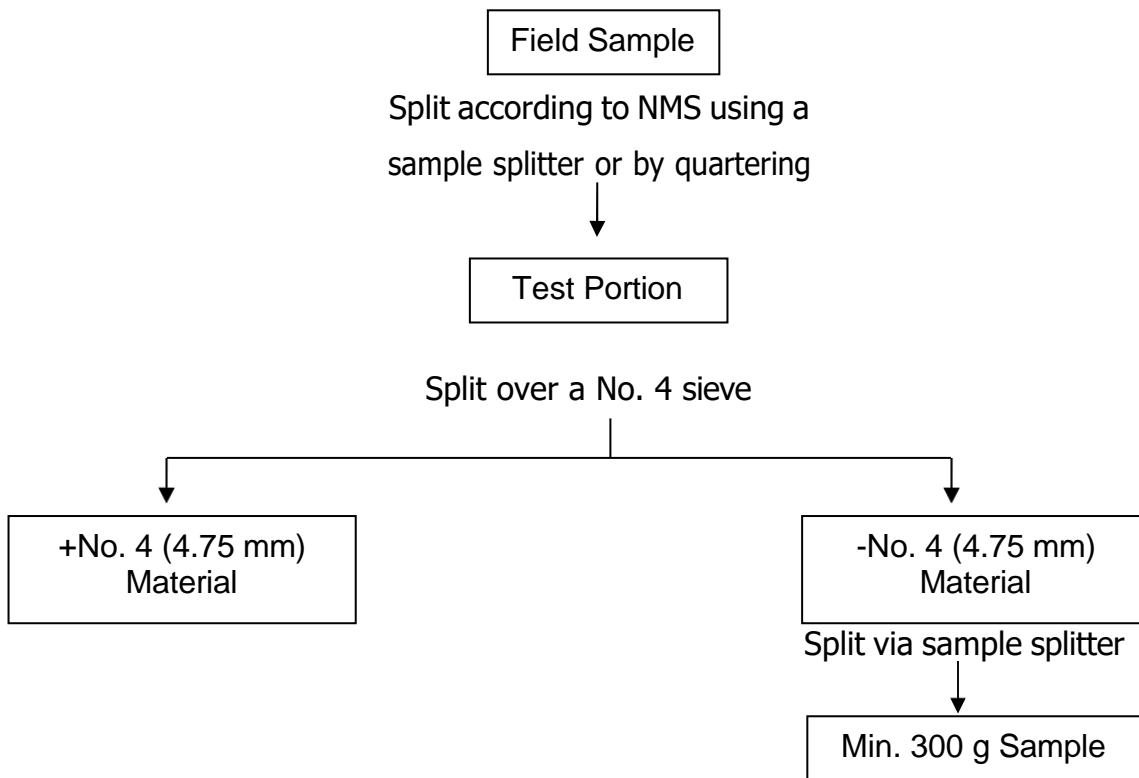

*Figure 3.3*

**First**, we will need to split the sample based on nominal maximum size (NMS) of the overall field sample using a large sample splitter or by quartering. Test portion minimum weights are listed in Table II of MP700.00.06 (page A-47) based on nominal maximum size. One important thing to note is that in some the classes of aggregate in Table 704.6.2 (page 1-24), there is no sieve with a range of X% - 100% passing. In this case the next standard sieve listed Table I of MP700.00.06 (page A-46) below the sieve in which 100% must pass will be the nominal maximum size of that aggregate. The Class 1 aggregate example, as listed in Table 704.6.2A (page 1-24), must have 100% passing the 1 1/2 in. (37.5 mm) sieve and 50%-90% passing the 3/4 in. (19.0 mm)



sieve. It appears from this table that the NMS is 3/4 in. (19.0 mm), but when we check Table I of MP700.00.06, we see that the next standard sieve below the 1 1/2 in. (37.5 mm) sieve is the 1 in. (25.0 mm) sieve. The NMS of the Class 1 aggregate example is 1 in. (25.0 mm) and the minimum oven dry test portion weight is 10,000 g. This stage of splitting is conducted as previously described for coarse and fine aggregate samples. The sample is split to a little more than the test portion size, to compensate for moisture loss, and oven dried to a constant mass at  $230 \pm 9^{\circ}\text{F}$  ( $110 \pm 5^{\circ}\text{C}$ ). After cooling to a comfortable temperature, the weight is determined to the nearest 0.1g and recorded on Line (A) of the T300. Assume that this mass is 12870.1 g for the Class 1 limestone example. Enter this value on page 3-68 and check its placement on page 3- 69.

The **second** stage of splitting involves splitting the sample into the coarse and fine fractions. The sample is placed in a large shaker with a No. 4 (4.75 mm) sieve on the bottom and a series of interceptors above. All material retained on the No. 4 (4.75 mm) sieve and above is combined for the +No. 4 (+4.75 mm) fraction of the sample. This mass is recorded on Line (C) of the T300. Assume that this mass is 9350.4 g for the example and record this on the proper place on page 3-68. Check its placement on page 3-69.

The **third** stage of splitting involves reducing the fine fraction to a convenient testing size. The material retained in the pan from the shaker is the minus No. 4 (-4.75 mm) fraction and the mass is recorded on Line (E) of the T300. Assume that this value is 3510.7 g in the example and record in the corresponding line on page 3-68. This is typically too much fine aggregate for sieving and will have to be further split down with a small sample splitter. When the sample is split to a minimum of 300 g, the mass is entered on Line (H). Assume that this value is 333.5 g for the example and record in the proper place on page 3-68. Check placement on page 3-69.

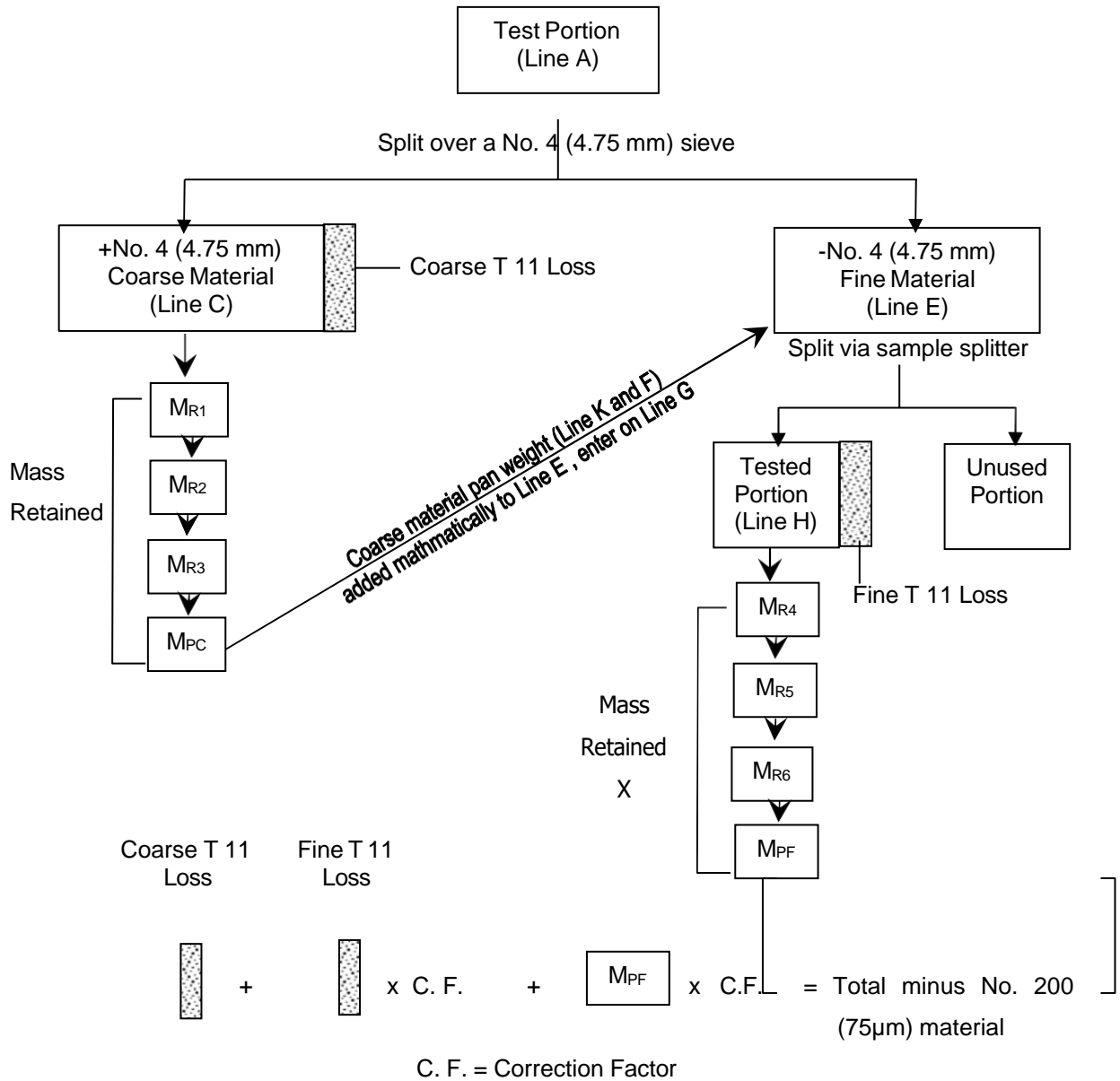

$$\text{Percent Retained} = \frac{\text{Mass Retained}}{\text{Initial Oven Dry Mass}} \times 100 = \% \text{ of Total}$$

**Figure 3.4**

**Illustration of entire process for conducting a combination gradation**

**Step (TWO) - T 11 Wash Test (If Required):**

The T11 wash test is to be completed as described in Parts II and III for both the coarse and fine aggregate fractions, respectively. The oven dry mass of the plus No. 4 (4.75 mm) material after T 11 will be recorded on Line (D). The oven dry mass of the minus No. 4 (4.75 mm) material after T 11 will be recorded on Line (I). Assume that the masses after T11 are 9299.6 g for the coarse fraction and 285.9 g for the fine fraction. Record these values in the proper places on page 3-68. Check their placement on the T300 on page 3-69.

The loss by T11 is determined in the same manner as in Parts II and III. The +No. 4 (4.75 mm) loss is recorded in the same places as was done for the coarse aggregates. The minus No. 4 (4.75 mm) loss by T11 is recorded on “Line O” but is not recorded in the “Fine -No. 200 Wet” place on the T300 at this time.

Determine the loss for the coarse and fine fractions of the example on page 3-68 and record the losses in the proper places. Check your answers and their placement on page 3-69.

**Step (THREE) - Dry Sieving:** Dry sieving is conducted in the same manner as that described for both coarse and fine aggregate samples in Parts II and III of this chapter. The masses retained for the coarse fraction are recorded in the “Combination” side of the “Mass Retained  $M_R$ ” column. There will be some material retained in the pan of the coarse shaker. This will be minus No. 4 (4.75 mm) material resulting from probable breakdown during dry sieving or from smaller particles adhering to larger particles during splitting and the T 11 wash test. The mass of the Pan material for the coarse fraction is recorded on Line (K) and on Line (F). This value is added to Line (E) “Oven Dry Mass of Minus No. 4 (4.75 mm) Material Used in Split” and is recorded on Line (G). The coarse pan mass is not used in the percent retained calculation for the plus No. 4 (4.75 mm) fraction. It is only mathematically added to (not actually poured into) the minus No. 4 (4.75 mm) portion to obtain a more accurate correction factor. By adding this small amount mathematically, the procedure is less time consuming and any loss in

accuracy is considered insignificant. If conditions demand exact accuracy, such as in a borderline situation, the pan material after sieving the coarse fraction may be sieved through the fine aggregate sieves and the masses added to the appropriate minus No. 4 (4.75 mm) values. This mass is also recorded under the “ (G) ” space in the correction factor calculation area in the middle right of the T300. The fine fraction weights retained are recorded in the “Regular” side of the “Mass Retained” column of the fine aggregate area.

Enter the weights retained in the table below for the Class 1 Limestone example in their proper places on page 3-68. Perform the associated calculations described above (E+F).

Coarse plus No. 4 (4.75 mm) Fraction		Fine minus No. 4 (4.75 mm) Fraction	
Sieve	Mass Retained	Sieve	Mass Retained
1 1/2 in. (37.5 mm)	0.0 g	No. 8 (2.36 mm)	104.6 g
1 in. (25.0 mm)	929.2 g	No. 16 (1.18 mm)	48.5 g
3/4 in. (19.0 mm)	2130.1 g	No. 40 (425 μm)	28.3 g
1/2 in. (12.5 mm)	2670.0 g	No. 50 (300 μm)	7.8 g
3/8 in. (9.5 mm)	1551.7 g	No. 100 (150 μm)	38.1 g
No. 4 (4.75 mm)	1941.2 g	No. 200 (75 μm)	57.9 g
Pan	80.2 g	Pan	0.6 g

**Step (FOUR) - Calculation and Application of the Correction Factor:**

Recall, prior to conducting the T11 test, we split the sample into plus No. 4 (4.75 mm) and minus No. 4 (4.75 mm) material. Then we split the minus No. 4 (4.75 mm) material into a smaller test portion. Before we can calculate the percent retained for the minus No. 4 (4.75 mm) material we must adjust the masses retained on those sieves to what they could have been had we tested the entire minus No. 4 (4.75 mm) fraction.

**Basically, we will be determining what fractional part of the minus No. 4 (4.75 mm)**

**we actually tested.** The first step is to determine how much of the sample was truly tested by adding all of the minus No. 4 (4.75 mm) masses retained, including the fine loss by T11. This value is recorded on Line (P) and in the space below (P) in the middle right of the T300. Next, we divide Line (G), the minus No. 4 (4.75 mm) material used in the split with the +No. 4 (4.75 mm) pan weight added (Lines E + F), by Line (P), the final total weight of the minus No. 4 (4.75 mm) material. This result is calculated and rounded to the nearest 0.0001 place and recorded in the “C. F. = \_\_\_\_\_” space in the middle right of the T300. “C.F.” stands for correction factor. The masses retained in the minus No. 4 (4.75 mm) sieving operation, including the loss by T 11, are then multiplied by this correction factor (C.F.). The results are then recorded to the nearest 0.1g in the “Combination” side of the “Mass Retained  $M_R$ ” column in the fine aggregate section. The adjusted mass retained in the pan and the adjusted loss by T 11 are also recorded in the “Fine minus No. 200 Dry” and “Fine minus No. 200 Wet” spaces, respectively, in the “Minus No. 200 Calculations” area.

Complete these calculations for the Class I aggregate example and record the results in the proper places on the T300 on page 3-68. Check your answers with the T300 on page 3-69.

**Step (FIVE) - Sample Loss or Gain and Overloaded Sieves Check:**

At this point we will have to add all the masses retained to determine the amount of loss or gain during testing. For the coarse fraction, add the values in the “Combination” side of the “Mass Retained  $M_R$ ” column (remember, do not include the coarse pan weight). This total is recorded on Line (M). For the fine fraction, the values adjusted with the correction factor are added together and the total entered on Line (Q). The totals on Lines (M) and (Q) are added together and recorded on Line (R). This number is then subjected to the same calculation for percentage loss or gain as was done in Parts II and III of this chapter using the initial weight on Line (A). Overloaded sieves can be checked as described in Parts II and III of this chapter. When checking for overloaded sieves in the minus No. 4 (4.75 mm) fraction, the non-adjusted weights are used.

Try the calculation and checking procedures just discussed for the example on page 3-68. If you have trouble, check the completed example on page 3-69.

**Step (SIX) - Calculation of the Percent Retained:**

Percent retained for all sieves in both fractions are to be calculated in the same way as they were for regular coarse or fine aggregate samples and recorded in the “% Retained” column. All percent of total sample for masses retained on each sieve are calculated to the nearest 0.1%.

Perform these calculations for the example on page 3-68 and check your results on page 3-69.

**Step (SEVEN) - Calculation of Percent Passing:**

Percent passing numbers are calculated in the same fashion as they were for both coarse and fine aggregate samples. There are two exceptions: (1) the percent passing the top sieve of the minus No. 4 (4.75 mm) fraction is added to the “% Retained” for the same sieve and this result is then recorded in the “Percent Passing” column for the bottom sieve in the plus No. 4 (4.75 mm) aggregate fraction. (2) The “Coarse -No. 200 Dry” weight should not be used since this weight was mathematically added to the fine fraction in Step (THREE). The “Minus No. 200” material calculation should be carried out several places (5 are recommended), truncated at the 0.01 place and recorded in the “Percent Passing” column. After all calculations are completed, the results are rounded to the whole number for all sieves above the No. 200 sieve, which is rounded to 0.1g. These values are recorded in the “Reported Percent Passing” column.

Determine the reported percent passing for the example on page 3-68 and check your answer on page 3-69.

**Step (EIGHT) - Evaluation Against Specifications to Determine Pass/Fail:**

The combination gradation sample is evaluated in the same way as regular coarse and fine aggregate samples are evaluated.

Check to see if the example passes specifications.

Work the practice problems on page 3-70 (Use the form on page 3-75) and 3-77.  
Check your answers with the answers on page 3-76 and 3-78.

Click To Begin

MATERIALS FINER THAN No. 200 SIEVE BY WASHING (AASHTO T-11)

Site Manager I.D.#:	Aggregate Size: Class 1	Spec Sieve Sizes	% Pass	Pass /Fail
Lab Reference Number:	Sieve Type Coarse: 12 Inch			
Technician:	Sieve Type Fine: 12 Inch			
Producer / Supplier Code:	Material Type: Lime Stone			
Producer / Supplier Name:	Contract #:			
Site Manager Material Code:	Project #:			
Date Sampled:	Auth #:			
Date Tested:	Item #:			
	Tons / CY			

- (A) Initial Oven Dry Mass of Total Sample ..... (A)
- (B) Oven Dry mass of Total Sample After T-11 ..... (B)
- (C) Oven Dry Mass of Plus No. 4 Material ..... (C)
- (D) Oven Dry Mass of Plus No. 4 Material After T-11 ..... (D)
- (E) Oven Dry Mass of Minus No. 4 Material Used in Split ..... (E)
- (F) Combination Gradation Coarse Fraction Pan Material After Dry Sieving (K) ..... (F)
- (G) Total Oven Dry Mass of Minus No. 4 Material (E+F) ..... (G)
- (H) Initial Oven Dry Mass of Total Fine Sample or Mass of Minus No. 4 Material ..... (H)
- (I) Oven Dry Mass of Total Fine Sample or Mass of Minus No. 4 Material After T-11 ..... (I)

Sieve Analysis of Coarse Aggregate

Sieve Size	Mass Retained $M_R$		Over Loading	% Retained $(M_R/A) \times 100$	Percent Passing	Reported Percent Passing	Material Specifications	
	Regular	Combination					Low	High

(J) Pan .....  
 (K) Combination Grad. Pan .....  
 (L) Loss By T-11 .....  
 (M) Final Total ( $\Sigma M_R$ ) .....

C. F. = (G) ÷ (P)  
 C. F. = ..... ÷ .....  
 C. F. = .....

Sieve Analysis of Fine Aggregate

Sieve Size	Mass Retained $M_R$		Over Loading	% Retained $(M_R/(H+R)) \times 100$	Percent Passing	Reported Percent Passing	Material Specifications	
	Regular	Combination					Low	High

(N) Pan .....  
 (O) Loss By T-11 .....  
 (P) Final Total Fine Sample ( $\Sigma M_R$ ) .....  
 (Q) Final Total - No. 4 ( $\Sigma M_R$ ) .....  
 (R) Combined Total (M+Q) .....  
 (S) Sample Loss or Gain (A-M) or (M-A) .....  
 (H-P) or (P-H) .....  
 (A-R) or (R-A) .....

Coarse - No. 200 Dry  
 Fine - No. 200 Dry  
 Coarse - No. 200 Wet  
 Fine - No. 200 Wet  
 Total - No. 200  
 ÷ Init. Mass (A) or (H)  
 x 100 = ..... %

Name: \_\_\_\_\_  
 Signature: \_\_\_\_\_  
 Date: \_\_\_\_\_

Remarks:	Pass/Fail	Lab Info Only:
----------	-----------	----------------



Click To Begin

MATERIALS FINER THAN No. 200 SIEVE BY WASHING (AASHTO T-11)

Site Manager I.D.#:	Aggregate Size: Class 1	Spec Sieve	% Pass	Pass /Fail
Lab Reference Number:	Sieve Type Coarse: 12 Inch	1 1/2 in. (37.5mm)	100	Pass
Technician:	Sieve Type Fine: 12 Inch	3/4 in. (19.0mm)	76	Pass
Producer / Supplier Code:	Material Type: Lime Stone	No. 4 (4.75mm)	28	Pass
Producer / Supplier Name:	Contract #:	No. 40 (425µm)	13	Pass
Site Manager Material Code:	Project #:	No. 200 (75µm)	4.4	Pass
Date Sampled:	Auth #:			
Date Tested:	Item #:			
	Tons / CY			

(A) Initial Oven Dry Mass of Total Sample .....	(A)	12870.1
(B) Oven Dry mass of Total Sample After T-11 .....	(B)	
(C) Oven Dry Mass of Plus No. 4 Material .....	(C)	9350.4
(D) Oven Dry Mass of Plus No. 4 Material After T-11 .....	(D)	9299.6
(E) Oven Dry Mass of Minus No. 4 Material Used in Split .....	(E)	3510.7
(F) Combination Gradation Coarse Fraction Pan Material After Dry Sieving (K) .....	(F)	80.2
(G) Total Oven Dry Mass of Minus No. 4 Material (E+F) .....	(G)	3590.9
(H) Initial Oven Dry Mass of Total Fine Sample or Mass of Minus No. 4 Material .....	(H)	333.5
(I) Oven Dry Mass of Total Fine Sample or Mass of Minus No. 4 Material After T-11 .....	(I)	285.9

Sieve Analysis of Coarse Aggregate

Sieve Size	Mass Retained M <sub>R</sub>		Over Loading	% Retained (M <sub>R</sub> /A)x100	Percent Passing	Reported Percent Passing	Material Specifications	
	Regular	Combination					Low	High
1 1/2 in. (37.5mm)		0.0	ok	0.0	100.12	100		100
1 in. (25.0mm)		929.2	ok	7.2	92.92	93		
3/4 in. (19.0mm)		2,130.1	ok	16.6	76.32	76	50	90
1/2 in. (12.5mm)		2,670.0	ok	20.7	55.62	56		
3/8 in. (9.5mm)		1,551.7	ok	12.1	43.52	44		
No. 4 (4.75mm)		1,941.2	ok	15.1	28.42	28	20	50
(J) Pan .....								
(K) Combination Grad. Pan .....								
(L) Loss By T-11 .....		50.8						
(M) Final Total (Σ M <sub>R</sub> )		9,273.0						

C. F. = (G) ÷ (P)  
C. F. = 3,590.9 ÷ 333.4  
C. F. = 10.7705

Sieve Analysis of Fine Aggregate

Sieve Size	Mass Retained M <sub>R</sub>		Over Loading	% Retained (M <sub>R</sub> /H) x100	Percent Passing	Reported Percent Passing	Material Specifications	
	Regular	Combination					Low	High
No. 8 (2.36mm)	104.6	1126.6	ok	8.8	19.62	20		
No. 16 (1.18mm)	48.5	522.4	ok	4.1	15.52	16		
No. 40 (425µm)	28.3	304.8	ok	2.4	13.12	13	5	20
No. 50 (300µm)	7.8	84.0	ok	0.7	12.42	12		
No. 100 (150µm)	38.1	410.4	ok	3.2	9.22	9		
No. 200 (75µm)	57.9	623.6	ok	4.8	4.42	4.4	0	7
(N) Pan .....	0.6	6.5						
(O) Loss By T-11 .....	47.6	512.7						
(P) Final Total Fine Sample (Σ M <sub>R</sub> ) .....	333.4							
(Q) Final Total - No. 4 (Σ M <sub>R</sub> ) .....		3591.0						
(R) Combined Total (M+Q) .....		12864.0						
(S) Sample Loss or Gain	(A-M) or (M-A) .....							
	(H-P) or (P-H) .....							
	(A-R) or (R-A) .....	6.1						
(T) Percentage of Initial OD Mass ((S/A)x100) or ((S/H)x100)		0.0						

Name: \_\_\_\_\_

Signature: \_\_\_\_\_

Date: \_\_\_\_\_

Remarks:	<b>Pass</b>	Lab Info Only:
----------	-------------	----------------

### **Exercise 3 Combination Gradation**

Complete the following steps to familiarize yourself with the calculations for a combination gradation. We will be using a Class 1 Limestone in this example. Use the blank T300 sheet on page 3-75. A completed T300 can be seen on page 3-76.

1. Fill in the identification information about the sample.
  - a. Information at the top of the T300.
    - Field Sample #, Tech. and Lab, and Date
  - b. Agg. Type just above the "Sieve Analysis of Coarse Aggregate" section of the T300
    - In this case (Class 1 Lmst).

### **Necessary Sieves and Specifications Determination:**

2. Determine the necessary sieves and enter them on the T300.
  - a. Sieves for a Class 1 and the corresponding percent passing specifications can be found in Table 704.6.2 on page 1-24 of this manual.
    - Assume that the 1 in. (25.0 mm), 1/2 in. (12.0 mm), 3/8 in. (9.5 mm), No. 8 (2.36 mm), No. 16 (1.18 mm), No. 50 (300  $\mu$ m), and No. 100 (150  $\mu$ m) sieves will be necessary interceptors for this aggregate
  - b. Enter the sieves starting with the largest sieve down to the No. 4 (4.75 mm) sieve, in the "Sieve Size" column of the "Sieve Analysis of Coarse Aggregate" section on the T300. List the smaller sieves in the "Sieve Analysis of Fine Aggregate" section.
  - c. Enter the ranges for percent passing for each specification sieve in the "Material Spec's" column adjacent to the corresponding sieve.

### **Sample Preparation, T 11 Wash Test, and Dry Sieving:**

3. Values recorded during each part of testing of this sample can be seen in the table on the next page.
  - a. Record the initial oven dry mass of the sample on Line (A) of the T300.
  - b. Record the oven dry mass of plus No. 4 (4.75 mm) material on Line (C) of the T300.
  - c. Record the oven dry mass of plus No. 4 (4.75 mm) material after T 11 on Line (D) of the T300.
  - d. Record the oven dry mass of minus No. 4 (4.75 mm) material used in the split on Line (E) of the T300.
  - e. Record the oven dry mass of minus No. 4 (4.75 mm) material on Line (H) of the T300.
  - f. Record the oven dry mass of minus No. 4 (4.75 mm) material after T 11 on Line (I) of the T300.

Initial oven dry mass			10804.0 g
Oven dry mass of plus No. 4 (4.75 mm) material.			7330.0 g
Oven dry mass of plus No. 4 (4.75 mm) mat. after T 11			7272.0 g
Oven dry mass of minus No. 4 (4.75 mm) material in split			3483.0 g
Oven dry mass of minus No. 4 (4.75 mm) material.			320.6 g
Oven dry mass of minus No. 4 (4.75 mm) mat. after T 11			259.3 g
1 1/2 in. (37.5 mm) sieve	0.0 g	No. 8 (2.36 mm) sieve	101.7 g
1 in. (25.0 mm) sieve	559.0 g	No. 16 (1.18 mm) sieve	75.6 g
3/4 in. (19.0 mm) sieve	1602.0 g	No. 40 (425 $\mu$ m) sieve	37.2 g
1/2 in. (12.0 mm) sieve	2488.0 g	No. 50 (300 $\mu$ m) sieve	9.9 g
3/8 in. (9.5 mm) sieve	1059.0 g	No. 100 (150 $\mu$ m) sieve	17.0 g
No. 4 (4.75 mm) sieve	1486.0 g	No. 200 (75 $\mu$ m) sieve	14.2 g
Coarse Pan	77.0 g	Fine Pan	3.5 g

- g. Record the masses retained for all sieves above and including the No. 4 (4.75 mm) sieve in the "Combination" side of the "Mass Retained  $M_R$ " column of the "Sieve Analysis of Coarse Aggregate" section next to the corresponding sieve.
  - h. Record the mass retained in the pan during the coarse aggregate sieving in the space on Line (K) and on Line (F).
  - i. Record the masses retained for all sieves below the No. 4 (4.75 mm) sieve in the "Regular" side of the "Mass Retained  $M_R$ " column of the "Sieve Analysis of Fine Aggregate" section next to the corresponding sieve.
  - j. Record the mass retained in the pan during the fine aggregate sieving in the space on Line (N) in the "Regular" side of the "Mass Retained  $M_R$ " column on the T300.
4. Determine the loss during T 11.
    - a. Subtract the mass of Oven Dry Plus No. 4 Material after T 11 on Line (D) from the Initial Oven Dry Mass Plus No. 4 Material on Line (C).
    - b. Record this difference on Line (L) on the "Combination" side. Also record this value in the "Coarse -No. 200 Wet" space in the "Minus No. 200 Calculations" area in the lower right of the T300.
    - c. Subtract the Oven Dry Mass of Total Minus No. 4 Material after T 11 on Line (I) from the Initial Oven Dry Mass of Total Minus No. 4 Material on Line (H).

- d. Record this difference on Line (O) – Loss by T11 - on the “Regular” side.

**Correction Factor Calculation and Application:**

5. Calculate the correction factor to adjust the minus No. 4 (4.75 mm) material values.
  - a. Add all the masses retained during the fine sieving and the loss by T 11 and record the answer on Line (P).
  - b. Add Line (E) the oven dry mass of minus No. 4 (4.75 mm) material used in the split to Line (F) the coarse pan material and record this weight on Line (G).
  - c. Record the values on Line (G) and Line (P) in the “C.F. =” section in the middle right of the T300.
  - d. Divide the Line (G) by Line (P) and record the result rounded to the nearest 0.0001 place on the line below.
6. Adjust the masses retained on the fine sieves using the correction factor (C.F.).
  - a. Multiply each mass retained on the fine sieves by the correction factor and record the rounded results to the nearest 0.1 g in the “Combination” side under the “Mass Retained  $M_R$ ” column in the fine aggregate section.
  - b. Record the adjusted fine pan material amount and the adjusted fine loss by T 11 in the “Fine -No. 200 Dry” and “Fine -No. 200 Wet” spaces of the “Minus No. 200 Calculations” area in the lower right of the T300.

**Overloaded Sieves and Sample Loss or Gain Check:**

7. Check for overloaded sieves.
  - a. Check the  $M_R$  on all sieves with the maximum amounts allowed on page 3-24. Use the non-adjusted weights for the fine fraction.
  - b. Indicate if the sieves are overloaded on the T300 with an asterisk next to the  $M_R$  column.
8. Calculate the percentage loss or gain.
  - a. Add all the masses retained and the loss by T 11 for the coarse fraction and record this value on Line (M) of the T300 under the “Combination” side. Exclude the coarse fraction pan material from this total.
  - b. Add all the masses retained, the pan material, and the loss by T 11 for the fine fraction on the “Combination” side and record this value on Line (Q).
  - c. Add the masses on Lines (M) and (Q) and record the result on Line (R).
  - d. Determine the difference between Line (R) and Line (A). Record this number on Line (S) in the “(A-R) or (R-A)” space.

- e. Determine the percentage loss by using the  $((S/A) \times 100)$  formula and record the answer to the nearest 0.1% on Line (T).

**Percent Retained Calculation:**

9. Calculate the percent retained on each sieve.

- a. Divide the mass retained on each sieve by the initial oven dry mass on Line (A) and record the result in the "Percent Retained  $M_R/A \times 100$ " column on the T300 next to the corresponding sieve.
  - Use the formula below and round values to the nearest 0.1%.

$$\text{Percent Retained} = \frac{\text{Mass Retained}}{\text{Initial Oven Dry Mass of Total Sample}} \times 100$$

**Percent Passing Calculation:**

10. Calculate the percent passing each sieve.

- a. Calculate the Percent Passing the No. 200 (75  $\mu\text{m}$ ) sieve in the "Minus No. 200 Calculations" area in the lower right of the T300.
- b. Add the "Coarse -No. 200 Wet", "Fine -No. 200 Dry", and the "Fine -No. 200 Wet" values and record the total in the "Total -No. 200" space.
- c. Record the initial oven dry mass in the space labeled " $\div$  Init. Mass (A) or (H)".
- d. Divide the "Total -No. 200" mass by the initial oven dry mass and multiply by 100.
- e. Record this percentage at the bottom of the "Minus No. 200 Calculations" area.
  - Record this percentage to 5 decimal places (**Do not round this number, just cut it off.**).
- f. Move the percent passing the No. 200 (75  $\mu\text{m}$ ) sieve up to the "Percent Passing" column on the line adjacent to the No. 200 (75  $\mu\text{m}$ ) sieve.
  - Cut this number off to two decimal places. **Do not round this number at this point.**
- g. Add the percent passing the No. 200 (75  $\mu\text{m}$ ) sieve, cut off to two decimal places (**not rounded**), to the percent retained on the No. 200 (75  $\mu\text{m}$ ) sieve and record the result in the "Percent Passing" column on the No. 100 (150  $\mu\text{m}$ ) sieve line.
- h. Repeat step (g.) for all remaining sieves in the fine aggregate section. Record the results to two decimal places. You should have the same number in the 0.01 place for all the sieves.
- i. Add the percent passing the No. 8 (2.36 mm) sieve to the percent retained on the No. 8 (2.36 mm) sieve and record this total on the No. 4 (4.75 mm) sieve line in the coarse aggregate section.
- j. Repeat step (i.) for all the remaining sieves in the coarse aggregate section.

11. Round the percent passing each sieve for reporting.
  - a. Round the percent passing for each sieve above the No. 200 (75  $\mu\text{m}$ ) sieve to the nearest 1% and record these numbers in the "Reported Percent Passing" column on the T300.
  - b. Round the percent passing the No. 200 (75  $\mu\text{m}$ ) sieve to the nearest 0.1%.

**Sample Evaluation:**

12. Evaluate the sample for specification compliance.
  - a. Look to see if any of the reported percent passing values fall outside the specified ranges.
13. Indicate passing or failing.
  - a. Record a "P" or an "F" in the "P/F/N" space in the top section of the T300.
  - b. Record the "Reported Percent Passing" only for the specification sieves in the spaces labeled "1st", "2nd", etc. at the top of the T300.
    - The percent passing the largest specification sieve will be listed in the "1st" space and the smallest sieve will be in the highest consecutive numbered space.
    - The percent passing the No. 200 (75  $\mu\text{m}$ ) sieve will always be listed in the "No. 200 (75  $\mu\text{m}$ )" if it is used.

Click To Begin

MATERIALS FINER THAN No. 200 SIEVE BY WASHING (AASHTO T-11)

Site Manager I.D.#:	Aggregate Size: Class 1	Spec Sieve Sizes	% Pass	Pass /Fail
Lab Reference Number:	Sieve Type Coarse: 12 Inch			
Technician:	Sieve Type Fine: 12 Inch			
Producer / Supplier Code:	Material Type: Lime Stone			
Producer / Supplier Name:	Contract #:			
Site Manager Material Code:	Project #:			
Date Sampled:	Auth #:			
Date Tested:	Item #:			
	Tons / CY			

- (A) Initial Oven Dry Mass of Total Sample ..... (A)
- (B) Oven Dry mass of Total Sample After T-11 ..... (B)
- (C) Oven Dry Mass of Plus No. 4 Material ..... (C)
- (D) Oven Dry Mass of Plus No. 4 Material After T-11 ..... (D)
- (E) Oven Dry Mass of Minus No. 4 Material Used in Split ..... (E)
- (F) Combination Gradation Coarse Fraction Pan Material After Dry Sieving (K) ..... (F)
- (G) Total Oven Dry Mass of Minus No. 4 Material (E+F) ..... (G)
- (H) Initial Oven Dry Mass of Total Fine Sample or Mass of Minus No. 4 Material ..... (H)
- (I) Oven Dry Mass of Total Fine Sample or Mass of Minus No. 4 Material After T-11 ..... (I)

Sieve Analysis of Coarse Aggregate

Sieve Size	Mass Retained M <sub>R</sub>		Over Loading	% Retained (M <sub>R</sub> /A)x100	Percent Passing	Reported Percent Passing	Material Specifications	
	Regular	Combination					Low	High
(J) Pan								
(K) Combination Grad. Pan								
(L) Loss By T-11								
(M) Final Total (Σ M <sub>R</sub> )								

C. F. = (G) ÷ (P)  
C. F. =            ÷             
C. F. =            ÷           

Sieve Analysis of Fine Aggregate

Sieve Size	Mass Retained M <sub>R</sub>		Over Loading	% Retained (M <sub>R</sub> /(H+R))x100	Percent Passing	Reported Percent Passing	Material Specifications	
	Regular	Combination					Low	High
(N) Pan								
(O) Loss By T-11								
(P) Final Total Fine Sample (Σ M <sub>R</sub> )								
(Q) Final Total - No. 4 (Σ M <sub>R</sub> )								
(R) Combined Total (M+Q)								
(S) Sample Loss or Gain	(A-M) or (M-A)							
	(H-P) or (P-H)							
	(A-R) or (R-A)							
(T) Percentage of Initial OD Mass ((S/A)x100) or ((S/H)x100)								

Name: \_\_\_\_\_

Signature: \_\_\_\_\_

Date: \_\_\_\_\_

Remarks:	<b>Pass/Fail</b>	Lab Info Only:
----------	------------------	----------------

WEST VIRGINIA DIVISION OF HIGHWAYS  
SIEVE ANALYSIS OF FINE AND COARSE AGGREGATE (AASHTO T-27)

Click To Begin

MATERIALS FINER THAN No. 200 SIEVE BY WASHING (AASHTO T-11)

Site Manager I.D.#:	Aggregate Size: Class 1	Spec Sieve	% Pass
Lab Reference Number:	Sieve Type Coarse: 12 Inch	Sizes	Pass /Fail
Technician:	Sieve Type Fine: 12 Inch	1 1/2 in. (37.5mm)	100 Pass
Producer / Supplier Code:	Material Type: Lime Stone	3/4 in. (19.0mm)	80 Pass
Producer / Supplier Name:	Contract #:	No. 4 (4.75mm)	34 Pass
Site Manager Material Code:	Project #:	No. 40 (425µm)	11 Pass
Date Sampled:	Auth #:	No. 200 (75µm)	7.2 Fail
Date Tested:	Item #:		
	Tons / CY		

(A) Initial Oven Dry Mass of Total Sample .....	(A)	10804.0
(B) Oven Dry mass of Total Sample After T-11 .....	(B)	
(C) Oven Dry Mass of Plus No. 4 Material .....	(C)	7330.0
(D) Oven Dry Mass of Plus No. 4 Material After T-11 .....	(D)	7272.0
(E) Oven Dry Mass of Minus No. 4 Material Used in Split.....	(E)	3483.0
(F) Combination Gradation Coarse Fraction Pan Material After Dry Sieving (K) .....	(F)	77.0
(G) Total Oven Dry Mass of Minus No. 4 Material (E+F).....	(G)	3560.0
(H) Initial Oven Dry Mass of Total Fine Sample or Mass of Minus No. 4 Material.....	(H)	320.6
(I) Oven Dry Mass of Total Fine Sample or Mass of Minus No. 4 Material After T-11.....	(I)	259.3

Sieve Analysis of Coarse Aggregate

Sieve Size	Mass Retained M <sub>R</sub>		Over Loading	% Retained (M <sub>R</sub> /A)x100	Percent Passing	Reported Percent Passing	Material Specifications	
	Regular	Combination					Low	High
1 1/2 in. (37.5mm)		0.0	ok	0.0	100.10	100		100
1 in. (25.0mm)		559.0	ok	5.2	94.90	95		
3/4 in. (19.0mm)		1,602.0	ok	14.8	80.10	80	50	90
1/2 in. (12.5mm)		2,488.0	ok	23.0	57.10	57		
3/8 in.(9.5mm)		1,059.0	ok	9.8	47.30	47		
No. 4 (4.75mm)		1,486.0	ok	13.8	33.50	34	20	50

(J) Pan .....								
(K) Combination Grad. Pan .....								
(L) Loss By T-11 .....		58						
(M) Final Total (Σ M <sub>R</sub> )		7,252.0						

C. F. = (G) ÷ (P)  
C. F. = 3,560.0 ÷ 320.4  
C. F. = 11.1111

Sieve Analysis of Fine Aggregate

Sieve Size	Mass Retained M <sub>R</sub>		Over Loading	% Retained (M <sub>R</sub> /(HorA) x100	Percent Passing	Reported Percent Passing	Material Specifications	
	Regular	Combination					Low	High
No. 8 (2.36mm)	101.7	1130.0	ok	10.5	23.00	23		
No. 16 (1.18mm)	75.6	840.0	ok	7.8	15.20	15		
No. 40 (425µm)	37.2	413.3	ok	3.8	11.40	11	5	20
No. 50 (300µm)	9.9	110.0	ok	1.0	10.40	10		
No. 100 (150µm)	17.0	188.9	ok	1.7	8.70	9		
No. 200 (75µm)	14.2	157.8	ok	1.5	7.20	7.2	0	7

(N) Pan.....	3.5	38.9						
(O) Loss By T-11.....	61.3	681.1	Coarse - No. 200 Dry		Fine - No. 200 Dry			38.9
(P) Final Total Fine Sample (Σ M <sub>R</sub> ).....	320.4		Coarse - No. 200 Wet	58.0	Fine - No. 200 Wet			681.1
(Q) Final Total - No. 4 (Σ M <sub>R</sub> ).....		3560.0	Total - No. 200	778.0	÷ Init. Mass (A) or (H)			10804.0
(R) Combined Total (M+Q).....		10812.0		x 100 =	7.20103			%
(S) Sample Loss or Gain	(A-M) or (M-A).....							
	(H-P) or (P-H).....							
	(A-R) or (R-A).....	8.0						
(T) Percentage of Initial OD Mass ((S/A)x100) or ((S/H)x100)		0.1						

Name:	
Signature:	
Date:	

Remarks:	<b>Fail</b>	Lab Info Only:
----------	-------------	----------------



Click To Begin

MATERIALS FINER THAN No. 200 SIEVE BY WASHING (AASHTO T-11)

Site Manager I.D.#:	Aggregate Size: Class 1	Spec Sieve Sizes	% Pass	Pass /Fail
Lab Reference Number:	Sieve Type Coarse: 12 Inch			
Technician:	Sieve Type Fine: 12 Inch			
Producer / Supplier Code:	Material Type: Lime Stone			
Producer / Supplier Name:	Contract #:			
Site Manager Material Code:	Project #:			
Date Sampled:	Auth #:			
Date Tested:	Item #:			
	Tons / CY			

(A) Initial Oven Dry Mass of Total Sample.....	(A)	11096.2
(B) Oven Dry mass of Total Sample After T-11.....	(B)	
(C) Oven Dry Mass of Plus No. 4 Material.....	(C)	7124.0
(D) Oven Dry Mass of Plus No. 4 Material After T-11.....	(D)	7077.7
(E) Oven Dry Mass of Minus No. 4 Material Used in Split.....	(E)	3948.7
(F) Combination Gradation Coarse Fraction Pan Material After Dry Sieving (K).....	(F)	
(G) Total Oven Dry Mass of Minus No. 4 Material (E+F).....	(G)	
(H) Initial Oven Dry Mass of Total Fine Sample or Mass of Minus No. 4 Material.....	(H)	308.9
(I) Oven Dry Mass of Total Fine Sample or Mass of Minus No. 4 Material After T-11.....	(I)	258.2

Sieve Analysis of Coarse Aggregate

Sieve Size	Mass Retained M <sub>R</sub>		Over Loading	% Retained (M <sub>R</sub> /A)x100	Percent Passing	Reported Percent Passing	Material Specifications	
	Regular	Combination					Low	High
1 1/2 in. (37.5mm)		0.0						
3/4 in. (19.0mm)		1,716.3						
3/8 in.(9.5mm)		3,074.8						
No. 4 (4.75mm)		2,210.2						
(J) Pan .....								
(K) Combination Grad. Pan .....								
(L) Loss By T-11.....								
(M) Final Total (Σ M <sub>R</sub> )								

C. F. = (G) ÷ (P)  
C. F. = \_\_\_\_\_ ÷ \_\_\_\_\_  
C. F. = \_\_\_\_\_

Sieve Analysis of Fine Aggregate

Sieve Size	Mass Retained M <sub>R</sub>		Over Loading	% Retained (M <sub>R</sub> /(H+A)x100	Percent Passing	Reported Percent Passing	Material Specifications	
	Regular	Combination					Low	High
No. 8 (2.36mm)	102.7							
No. 16 (1.18mm)	75.0							
No. 40 (425µm)	47.4							
No. 200 (75µm)	31.6							
(N) Pan.....	1.0							
(O) Loss By T-11.....								
(P) Final Total Fine Sample (Σ M <sub>R</sub> ).....								
(Q) Final Total - No. 4 (Σ M <sub>R</sub> ).....								
(R) Combined Total (M+Q).....								
(S) Sample Loss or Gain	(A-M) or (M-A).....							
	(H-P) or (P-H).....							
	(A-R) or (R-A).....							
(T) Percentage of Initial OD Mass ((S/A)x100) or ((S/H)x100)								

Name:	
Signature:	
Date:	

Remarks:	Pass/Fail	Lab Info Only:
----------	-----------	----------------

Click To Begin

MATERIALS FINER THAN No. 200 SIEVE BY WASHING (AASHTO T-11)

Site Manager I.D.#:	Aggregate Size: Class 1	Spec Sieve Sizes	% Pass	Pass /Fail
Lab Reference Number:	Sieve Type Coarse: 12 Inch	1 1/2 in. (37.5mm)	100	Pass
Technician:	Sieve Type Fine: 12 Inch	3/4 in. (19.0mm)	84	Pass
Producer / Supplier Code:	Material Type: Lime Stone	No. 4 (4.75mm)	37	Pass
Producer / Supplier Name:	Contract #:	No. 40 (425µm)	10	Pass
Site Manager Material Code:	Project #:	No. 200 (75µm)	6.5	Pass
Date Sampled:	Auth #:			
Date Tested:	Item #:			
	Tons / CY			

(A) Initial Oven Dry Mass of Total Sample .....	(A)	11096.2
(B) Oven Dry mass of Total Sample After T-11 .....	(B)	
(C) Oven Dry Mass of Plus No. 4 Material .....	(C)	7124.0
(D) Oven Dry Mass of Plus No. 4 Material After T-11 .....	(D)	7077.7
(E) Oven Dry Mass of Minus No. 4 Material Used in Split.....	(E)	3948.7
(F) Combination Gradation Coarse Fraction Pan Material After Dry Sieving (K) .....	(F)	72.1
(G) Total Oven Dry Mass of Minus No. 4 Material (E+F).....	(G)	4020.8
(H) Initial Oven Dry Mass of Total Fine Sample or Mass of Minus No. 4 Material.....	(H)	308.9
(I) Oven Dry Mass of Total Fine Sample or Mass of Minus No. 4 Material After T-11.....	(I)	258.2

Sieve Analysis of Coarse Aggregate

Sieve Size	Mass Retained M <sub>R</sub>		Over Loading	% Retained (M <sub>R</sub> /A)x100	Percent Passing	Reported Percent Passing	Material Specifications	
	Regular	Combination					Low	High
1 1/2 in. (37.5mm)		0.0	ok	0.0	99.79	100	100	100
3/4 in. (19.0mm)		1,716.3	ok	15.5	84.29	84	50	90
3/8 in. (9.5mm)		3,074.8	ok	27.7	56.59	57		
No. 4 (4.75mm)		2,210.2	ok	19.9	36.69	37	20	50
(J) Pan .....								
(K) Combination Grad. Pan .....								
(L) Loss By T-11 .....		46.3						
(M) Final Total (Σ M <sub>R</sub> )		7,047.6						
				C. F. =	(G)	÷	(P)	
				C. F. =	4,020.8	÷	308.4	
				C. F. =	13.0376			

Sieve Analysis of Fine Aggregate

Sieve Size	Mass Retained M <sub>R</sub>		Over Loading	% Retained (M <sub>R</sub> /HorA) x100	Percent Passing	Reported Percent Passing	Material Specifications	
	Regular	Combination					Low	High
No. 8 (2.36mm)	102.7	1339.0	ok	12.1	24.59	25		
No. 16 (1.18mm)	75.0	977.8	ok	8.8	15.79	16		
No. 40 (425µm)	47.4	618.0	ok	5.6	10.19	10	5	20
No. 200 (75µm)	31.6	412.0	ok	3.7	6.49	6.5	0	7
(N) Pan.....	1.0	13.0						
(O) Loss By T-11.....	50.7	661.0						
(P) Final Total Fine Sample (Σ M <sub>R</sub> )....	308.4							
(Q) Final Total - No. 4 (Σ M <sub>R</sub> ).....		4020.8						
(R) Combined Total (M+Q).....		11068.4						
(S) Sample Loss or Gain	(A-M) or (M-A).....							
	(H-P) or (P-H).....							
	(A-R) or (R-A).....	27.8						
(T) Percentage of Initial OD Mass ((S/A)x100) or ((S/H)x100)		0.3						

Name:	
Signature:	
Date:	

Remarks:	<b>Fail</b>	Lab Info Only:
----------	-------------	----------------

## PART V

### **DEVELOPMENT AND USE OF $\bar{A}$ (A - BAR) FACTORS**

By this time in the study of gradation analysis you should feel fairly confident in what you are attempting to achieve. But, before we leave this subject, we want to point out another procedure used in the acceptance of aggregate that is directly related to gradation. This procedure is the  $\bar{A}$  (A-bar) calculation.  $\bar{A}$  is a factor that characterizes the gradation of an aggregate. The size of this factor is very highly correlated with aggregate surface area. It affects such parameters as the asphalt demand in bituminous concrete paving mixtures and the mix water required for a given consistency (slump) of Portland Cement Concrete (PCC). In West Virginia it is used as a control in concrete mix designs.

The calculation of  $\bar{A}$  is straightforward and is completely described in **Materials Procedure 601.03.51**; Standard Method for Determination of  $\bar{A}$  of the Total Solids in Portland Cement Concrete.

Solid components in Portland Cement Concrete (PCC) include coarse aggregate, fine aggregate, cement, and sometimes fly ash. An  $\bar{A}$  gradation must be conducted on both the coarse and the fine aggregates. **The following sieve sizes are used: 1 1/2 in. (37.5 mm), 3/4 in. (19.0 mm), 3/8 in. (9.5 mm), No. 4 (4.75 mm), No. 8 (2.36 mm), No. 16 (1.18 mm), No. 30 (600  $\mu\text{m}$ ), No. 50 (300  $\mu\text{m}$ ), No. 100 (150  $\mu\text{m}$ ), and No. 200 (75  $\mu\text{m}$ ).** This group of sieves might appear to require a combination gradation analysis similar to that described in the last section. When we look at the sizes and types of aggregates used in PCC, we can see that a combination gradation is not necessary. An example of a coarse aggregate size used for PCC is an AASHTO No. 67. As can be seen from the specifications for No. 67 (page 1-23), the smallest specification sieve is the No. 8 (2.36 mm) and there should be less than 5% passing. When smaller sieves are used in the test, the percent retained on each is usually very small or zero.

Therefore, ***in a coarse  $\bar{A}$  gradation, percents passing sieves below the bottom specification sieve are to be reported as 0% with the exception of the No. 200 (75  $\mu\text{m}$ ) sieve.*** Recall from Section 703.4 there is a requirement for minus No. 200 (75  $\mu\text{m}$ ) material for PCC aggregates, so it will be necessary to determine the percent passing for this sieve. A coarse  $\bar{A}$  gradation analysis, sieves for which are listed in the table below, consists of conducting a T11 wash test on the entire sample, dry sieving the sample in a large mechanical shaker with a No. 8 (2.36 mm) sieve on the bottom, and then dry sieving the minus No. 8 (2.36 mm) material in a Rotap shaker using 8 inch (203.2 mm) sieves. The finer  $\bar{A}$  sieves may be included as interceptors above the No. 200 (75  $\mu\text{m}$ ) sieve in the Rotap shaker but the mass of any material retained on these sieves should be added to the mass of the material retained on the No. 200 (75  $\mu\text{m}$ ) sieve. Various aggregates may warrant different approaches to a coarse  $\bar{A}$  gradation.

Fine aggregate for PCC is predominantly material passing the No. 4 (4.75 mm) sieve and should have 100% passing all larger sieves. Assuming 100% passing these sieves makes testing with larger sieves unnecessary. Section 702.1.2 specifies a limit for the amount of minus No. 200 (75  $\mu\text{m}$ ) material in fine aggregate for PCC. A fine  $\bar{A}$  gradation analysis consists of a T11 wash test and a dry sieving of the material using the 3/8 in. (9.5 mm) sieve and a No. 200 (75  $\mu\text{m}$ ) sieve. Various aggregates may warrant different approaches to a fine  $\bar{A}$  gradation. The sieves for this gradation are listed in the table below

<u>Typical Coarse <math>\bar{A}</math> Gradation Analysis</u>		<u>Typical Fine <math>\bar{A}</math> Gradation Analysis</u>	
<u>Coarse Dry Sieves and Interceptors</u>		<u>Fine Dry Sieves</u>	
1 1/2 in.	(37.5 mm)	3/8 in.	(9.5 mm)
1 in.	(25.0 mm) – interceptor	No. 4	(4.75 mm)
3/4 in.	(19.0 mm)	No. 8	(2.36 mm)
1/2 in.	(12.5 mm) – interceptor	No. 16	(1.18 mm)
3/8 in.	(9.5 mm)	No. 30	(600 $\mu\text{m}$ )
No. 4	(4.75 mm)	No. 50	(300 $\mu\text{m}$ )
No. 8	(2.36 mm)	No. 100	(150 $\mu\text{m}$ )
<u>Fine Dry Sieves and Interceptors</u>		No. 200	(75 $\mu\text{m}$ )
Various interceptor sieves			
No. 200	(75 $\mu\text{m}$ )		

### **Specifications:**

Specifications for evaluating  $\bar{A}$  tolerance can be found in sections of the West Virginia Standard Specifications corresponding to the particular concrete item being produced. Specifications require that two calculated parameters be in compliance for all  $\bar{A}$  samples. The first requirement is that the calculated  $\bar{A}$  value falls within a certain tolerance of the target  $\bar{A}$  value. The second requirement is related to the total percent passing the No. 200 (75  $\mu\text{m}$ ) sieve for the aggregates. The actual percent passing the No. 200 (75  $\mu\text{m}$ ) sieve for the coarse and fine aggregates are adjusted to their mix design proportions. Then the total maximum allowed percent passing the No. 200 (75  $\mu\text{m}$ ) sieve are calculated. The total maximum allowed minus No. 200 (75  $\mu\text{m}$ ) percentage is based on the specifications for each aggregate (Sections 702.1.2 and 703.4) and adjusted to the mix proportions of each aggregate. If the total actual adjusted minus No. 200 (75  $\mu\text{m}$ ) percent exceeds the total maximum allowed minus No. 200 (75  $\mu\text{m}$ ) percent, the sample will fail. Samples must meet both requirements to be considered passing. With these two specification parameters in mind, we will now discuss their calculation.

### **$\bar{A}$ Calculations:**

The form used for  $\bar{A}$  calculation is the T301. A copy of this form can be seen on page 3-84. We will again use an example problem to explain the calculations.

Pertinent sample information is recorded on the form; especially the type and size of aggregate which is recorded in the "CA" and "FA" spaces on the T301. Then the percentages passing each of the  $\bar{A}$  sieves, including those assumed to be 100% or 0%, are recorded in their proper places for both the coarse and fine aggregates. Note that this information and these values have been recorded on the T301 on page 3-84. These percentages are then added together, and the total divided by 100. These results rounded to the 0.01 place are the  $\bar{A}$  values for each of the solid components in the concrete mix. Complete the calculations on the T301 on page 3-84. Answers can be checked against the completed T301 on page 3-85.

Each solid component makes up a certain fractional part, or percentage, of the total solids in the concrete mix. The  $\bar{A}$  values for each component must be adjusted to these fractional parts before being totaled for the mix. The amounts for each of these components are found in the mix design for the particular producer and specified concrete mix. The mix design masses for the coarse aggregate, fine aggregate, and cement should be recorded in the “ $M_{ca}$ ”, “ $M_{fa}$ ”, and “ $M_c$ ” spaces on the T301, respectively. The fractional parts of each solid component are then calculated on the form in the space provided. It is important to note that these fractional parts should be rounded to the nearest 0.001. Perform these calculations in the example on page 3-84 and check your results on page 3-85.

The  $\bar{A}$  values for each solid component, are to be multiplied by the fractions of each solid. This calculation is to be done on the lower left side of the T301. The results of this calculation will be the  $\bar{A}$  values for each solid component adjusted to their relative percentage of the total solids in the concrete mix. These adjusted values are to be totaled and the result recorded in the “ $\bar{A}$  Total Solids” space on the T301.  $\bar{A}$  values are rounded to the 0.01 place. Complete these calculations on the example on page 3-84 and check your answers on page 3-85.

Mix designs for various types of concrete will have a target  $\bar{A}$  value calculated and indicated on the mix design form. Specifications will set a range above and below this target value for a particular type of concrete based on the AASHTO size of aggregate used. Samples are evaluated as passing or failing based on whether their  $\bar{A}$  values fall inside or outside of this range. Specification ranges can be found in the Standard Specifications for specific concrete items (Sections 501 and 601). Assume that the range for this item is  $\pm 0.25$  for the example problem.

Minus No. 200 (75  $\mu$ m) Specification Calculations:

Recall that there is one additional check required for  $\bar{A}$  sample evaluation, the minus No. 200 (75  $\mu$ m) specification limit. Sections 702 and 703 set minus No. 200 (75  $\mu$ m)

material limits for various aggregate types. Before evaluation, the percent passing the No. 200 (75  $\mu\text{m}$ ) sieve for both the coarse and fine aggregate must be adjusted to their corresponding percentages, or fractional parts, of the total aggregate. The fractional parts of the coarse and fine aggregate can be determined as indicated on the lower right of the T301. The actual percentages passing the No. 200 (75  $\mu\text{m}$ ) sieve are then adjusted with these fractional parts in the bottom right hand corner of the form and the results totaled. The maximum allowable percentages passing the No. 200 (75  $\mu\text{m}$ ) sieve (from sections 702.1.3 and 703.4 of the WV Specifications book) for each fraction are then adjusted and the results also totaled. If the adjusted actual minus No. 200 (75  $\mu\text{m}$ ) percentage total does not exceed the adjusted maximum percentage total, then the sample will pass. Perform these calculations on the T301 on page 3-84 and check your results on page 3-85.

Evaluate the sample assuming the  $\bar{A}$  tolerance listed above and the minus No. 200 (75  $\mu\text{m}$ ) criteria described above. Check you answer on page 3-86. Complete the problem on page 3-86 and check with the example on page 3-87.

Lab Number	Project and Contract C					Date Sampled		Transmit Date	
Test Sequence	Material Code		Quantity			Item Number	Plant Source Code		Aggregate Source Code
Sieves:	1st	2nd	3rd	4th	5th	6th	7th	8th	No. 200
Design Number				Unit Weight	Face Fracture % One	% Two	LL	PL	PI
AASHTO Size	Smallest Sieve 100%		Target A-bar 5.07	Actual A-bar	FA A-bar	CA No. 200	FA No. 200	Total No. 200	P/F/N

Plant Name \_\_\_\_\_ Source Coarse Agg. \_\_\_\_\_

Technician \_\_\_\_\_ Date \_\_\_\_\_ Source Fine Agg. \_\_\_\_\_

Class of Concrete \_\_\_\_\_ Cmnt Fact \_\_\_\_\_ Field Sample # \_\_\_\_\_

Sieves	CA #57 Lmst	FA Silica Sand	Cement	Total Mass of Each Solid at SSD in One yd <sup>3</sup> of Concrete From Mix Design		
1 1/2 in. % pass	100	100	100	M <sub>ca</sub>	1724	lb
3/4 in. % pass	100	100	100	M <sub>fa</sub>	1385	lb
3/8 in. % pass	30	100	100	M <sub>ca</sub> + M <sub>fa</sub>		lb
No. 4 % pass	2	99	100	*M <sub>c</sub>	518	lb
No. 8 % pass	2	87	100	M <sub>t</sub>		lb
No. 16 % pass	0	70	100	Fractional Part of Each Solid (0.001)		
No. 30 % pass	0	53	100	M <sub>ca</sub>	=	=
No. 50 % pass	0	14	100	M <sub>t</sub>		
No. 100 % pass	0	4	100	M <sub>fa</sub>	=	=
No. 200 % pass	1.1	2.2	100	M <sub>t</sub>		
Total			1000.0	*M <sub>c</sub>	=	=
Solid A's			10.00	M <sub>t</sub>		

Solid Fraction x Each Solid A				Fractional Part of Coarse and Fine Agg. (0.001)			
Coarse Agg	x	=	A <sub>ca</sub>	F <sub>ca</sub>	=	M <sub>ca</sub>	=
Fine Agg	x	=	A <sub>fa</sub>			M <sub>ca</sub> + M <sub>fa</sub>	
Cement	x	10.00	=	A <sub>c</sub>	F <sub>fa</sub>	=	M <sub>fa</sub>
						M <sub>ca</sub> + M <sub>fa</sub>	=

Adjusted and Maximum Minus No. 200 Based on Fractional Part of Total Aggregate (0.01)

- No. 200 % pass x	F <sub>ca</sub> or F <sub>fa</sub>	=	Adjusted Total - 200 CA + FA
CA	x	=	
FA	x	=	
- No. 200 Spec Limit x	F <sub>ca</sub> or F <sub>fa</sub>	=	Max. Allowed Total - 200 CA + FA
CA	1.5 x	=	
FA	3.0 x	=	

A Total Solids  $\bar{A}_{ca} + \bar{A}_{fa} + \bar{A}_c$  \_\_\_\_\_  
 Target A 5.07  
 A Tolerance  $\pm$  \_\_\_\_\_  
 Total A P/F \_\_\_\_\_



T301E  
Rev. 1-05

WEST VIRGINIA DIVISION OF HIGHWAYS  
MATERIALS CONTROL, SOIL AND TESTING  
A CALCULATION WORKSHEET

F. S. # \_\_\_\_\_  
Tech. \_\_\_\_\_  
Date \_\_\_\_\_

Lab Number	Project and Contract					Date Sampled			Transmit Date	
Test Sequence	Material Code		Quantity			Item Number	Plant Source Code		Aggregate Source Code	
Sieves:	1st	2nd	3rd	4th	5th	6th	7th	8th	No. 200	
Design Number				Unit Weight	Face Fracture % One % Two		LL	PL	PI	
AASHTO Size	Smallest Sieve 100%		Target A-bar	Actual A-bar	FA A-bar	CA No. 200	FA No. 200	Total No. 200	P/F/N	
			5.07	4.95	6.29	1.1	2.2	1.6		

Plant Name \_\_\_\_\_ Source Coarse Agg. \_\_\_\_\_  
 Technician \_\_\_\_\_ Date \_\_\_\_\_ Source Fine Agg. \_\_\_\_\_  
 Class of Concrete \_\_\_\_\_ Cmnt Fact \_\_\_\_\_ Field Sample # \_\_\_\_\_

Sieves	CA #57 Lmst	FA Silica Sand	Cement	Total Mass of Each Solid at SSD in One yd <sup>3</sup> of Concrete From Mix Design	
1 1/2 in. % pass	100	100	100	M <sub>ca</sub>	1724 lb
3/4 in. % pass	100	100	100	M <sub>fa</sub>	1385 lb
3/8 in. % pass	30	100	100	M <sub>ca</sub> + M <sub>fa</sub>	3109 lb
No. 4 % pass	2	99	100	*M <sub>c</sub>	518 lb
No. 8 % pass	2	87	100	M <sub>t</sub>	3627 lb
No. 16 % pass	0	70	100	Fractional Part of Each Solid (0.001)	
No. 30 % pass	0	53	100	M <sub>ca</sub> =	1724 / 3627 = 0.475
No. 50 % pass	0	14	100	M <sub>fa</sub> =	1385 / 3627 = 0.382
No. 100 % pass	0	4	100	*M <sub>c</sub> =	518 / 3627 = 0.143
No. 200 % pass	1.1	2.2	100	M <sub>t</sub>	3627
Total	235.1	629.2	1000.0		
Solid A's	2.35	6.29	10.00		

	Solid Fraction x Each Solid A			
Coarse Agg	0.475	x	2.35	= 1.12 A <sub>ca</sub>
Fine Agg	0.382	x	6.29	= 2.40 A <sub>fa</sub>
Cement	0.143	x	10.00	= 1.43 A <sub>c</sub>

* Include Mass of Fly Ash When Used.			
Fractional Part of Coarse and Fine Agg. (0.001)			
F <sub>ca</sub>	=	M <sub>ca</sub>	= 1724 / 3109 = 0.555
F <sub>fa</sub>	=	M <sub>fa</sub>	= 1385 / 3109 = 0.445

Adjusted and Maximum Minus No. 200 Based on Fractional Part of Total Aggregate (0.01)

- No. 200 % pass x F <sub>ca</sub> or F <sub>fa</sub>	=	Adjusted Total - 200 CA + FA
CA	1.1 x 0.555 = 0.61	
FA	2.2 x 0.445 = 0.98	1.6
- No. 200 Spec Limit x F <sub>ca</sub> or F <sub>fa</sub>	=	Max. Allowed Total - 200 CA + FA
CA	1.5 x 0.555 = 0.83	
FA	3.0 x 0.445 = 1.34	2.2

A <sub>Total Solids</sub>	A <sub>ca</sub> + A <sub>fa</sub> + A <sub>c</sub>	4.95
Target A		5.07
A <sub>Tolerance ±</sub>		0.25
Total A P/F		P

Lab Number	Project and Contract					Date Sampled		Transmit Date	
Test Sequence	Material Code		Quantity		Item Number	Plant Source Code		Aggregate Source Code	
Sieves:	1st	2nd	3rd	4th	5th	6th	7th	8th	No. 200
Design Number				Unit Weight	Face Fracture % One	% Two	LL	PL	PI
AASHTO Size	Smallest Sieve 100%	Target A-bar 5.40		Actual A-bar	FA A-bar	CA No. 200	FA No. 200	Total No. 200	P/F/N

Plant Name \_\_\_\_\_ Source Coarse Agg. \_\_\_\_\_

Technician \_\_\_\_\_ Date \_\_\_\_\_ Source Fine Agg. \_\_\_\_\_

Class of Concrete \_\_\_\_\_ Cmmt Fact \_\_\_\_\_ Field Sample # \_\_\_\_\_

Sieves	CA	FA	Cement	Total Mass of Each Solid at SSD in One yd <sup>3</sup> of Concrete From Mix Design
	#57 Gravel UC	Lmst Sand		
1 1/2 in. % pass	100	100	100	M <sub>ca</sub> = 1740 lb
3/4 in. % pass	100	100	100	M <sub>fa</sub> = 1184 lb
3/8 in. % pass	46	100	100	M <sub>ca</sub> + M <sub>fa</sub> = _____ lb
No. 4 % pass	6	96	100	*M <sub>c</sub> = 657 lb
No. 8 % pass	2	83	100	M <sub>t</sub> = _____ lb
No. 16 % pass	0	65	100	Fractional Part of Each Solid (0.001)
No. 30 % pass	0	43	100	M <sub>ca</sub> = _____ = _____
No. 50 % pass	0	10	100	M <sub>t</sub> = _____
No. 100 % pass	0	3	100	M <sub>fa</sub> = _____ = _____
No. 200 % pass	2.3	2.9	100	M <sub>t</sub> = _____
Total			1000.0	*M <sub>c</sub> = _____ = _____
Solid A's			10.00	M <sub>t</sub> = _____

Solid Fraction x Each Solid A

Coarse Agg	x	=	A <sub>ca</sub>
Fine Agg	x	=	A <sub>fa</sub>
Cement	x 10.00	=	A <sub>c</sub>

Fractional Part of Coarse and Fine Agg. (0.001)

F <sub>ca</sub>	=	M <sub>ca</sub>	=	=
		M <sub>ca</sub> + M <sub>fa</sub>		
F <sub>fa</sub>	=	M <sub>fa</sub>	=	=
		M <sub>ca</sub> + M <sub>fa</sub>		

Adjusted and Maximum Minus No. 200 Based on Fractional Part of Total Aggregate (0.01)

- No. 200 % pass x F <sub>ca</sub> or F <sub>fa</sub>	=	Adjusted Total - 200 CA + FA
CA	x	=
FA	x	=
- No. 200 Spec Limit x F <sub>ca</sub> or F <sub>fa</sub>	=	Max. Allowed Total - 200 CA + FA
CA	1.0 x	=
FA	5.0 x	=

Lab Number	Project and Contract					Date Sampled		Transmit Date	
Test Sequence	Material Code		Quantity			Item Number	Plant Source Code	Aggregate Source Code	
Sieves:	1st	2nd	3rd	4th	5th	6th	7th	8th	No. 200
Design Number				Unit Weight	Face Fracture % One	% Two	LL	PL	PI
AASHTO Size		Smallest Sieve 100%	Target A-bar 5.40	Actual A-bar 5.07	FA A-bar 6.03	CA No. 200 2.3	FA No. 200 2.9	Total No. 200 2.5	P/F/N F

Plant Name \_\_\_\_\_ Source Coarse Agg. \_\_\_\_\_  
 Technician \_\_\_\_\_ Date \_\_\_\_\_ Source Fine Agg. \_\_\_\_\_  
 Class of Concrete \_\_\_\_\_ Cmnt Fact \_\_\_\_\_ Field Sample # \_\_\_\_\_

Sieves	CA #57 Lmst	FA Silica Sand	Cement	Total Mass of Each Solid at SSD in One yd <sup>3</sup> of Concrete From Mix Design
1 1/2 in. % pass	100	100	100	M <sub>ca</sub> = 1740 lb
3/4 in. % pass	100	100	100	M <sub>fa</sub> = 1184 lb
3/8 in. % pass	46	100	100	M <sub>ca</sub> + M <sub>fa</sub> = 2924 lb
No. 4 % pass	6	96	100	*M <sub>c</sub> = 657 lb
No. 8 % pass	2	83	100	M <sub>t</sub> = 3581 lb
No. 16 % pass	0	65	100	Fractional Part of Each Solid (0.001)
No. 30 % pass	0	43	100	M <sub>ca</sub> = 1740 = 0.486
No. 50 % pass	0	10	100	M <sub>t</sub> = 3581
No. 100 % pass	0	3	100	M <sub>fa</sub> = 1184 = 0.331
No. 200 % pass	2.3	2.9	100	M <sub>t</sub> = 3581
Total	256.3	602.9	1000.0	*M <sub>c</sub> = 657 = 0.183
Solid A's	2.56	6.03	10.00	M <sub>t</sub> = 3581

	Solid Fraction x Each Solid A			
Coarse Agg	0.486	x	2.56	= 1.24 A <sub>ca</sub>
Fine Agg	0.331	x	6.03	= 2.00 A <sub>fa</sub>
Cement	0.183	x	10.00	= 1.83 A <sub>c</sub>

* Include Mass of Fly Ash When Used.			
Fractional Part of Coarse and Fine Agg. (0.001)			
F <sub>ca</sub>	=	M <sub>ca</sub>	= 1740 = 0.595
		M <sub>ca</sub> + M <sub>fa</sub>	2924
F <sub>fa</sub>	=	M <sub>fa</sub>	= 1184 = 0.405
		M <sub>ca</sub> + M <sub>fa</sub>	2924

Adjusted and Maximum Minus No. 200 Based on Fractional Part of Total Aggregate (0.01)

- No. 200 % pass x F <sub>ca</sub> or F <sub>fa</sub> =	Adjusted Total - 200 CA + FA
CA 2.3 x 0.595 = 1.37	
FA 2.9 x 0.405 = 1.17	2.5
- No. 200 Spec Limit x F <sub>ca</sub> or F <sub>fa</sub> =	Max. Allowed Total - 200 CA + FA
CA 1.0 x 0.595 = 0.60	
FA 5.0 x 0.405 = 2.02	2.6

## **PART VI**

### **MATERIALS ACCEPTANCE PROCEDURES**

Another procedure used in the acceptance of aggregates related to gradations is the comparison of the contractor's gradation results to the gradation results generated by the District. This comparison procedure is documented in Material Procedure (MP) 700.00.54 entitled "Procedure for Evaluating Quality Control Sample Test Results with Verification Sample Test Results".

According to statements in the specifications and support documents, when placing an aggregate item, or material, on any project, the item must be sampled and tested at certain frequencies. For example, when the contractor places base course he must take a sample every half day of placement. Section 700.3.2 of the Construction Manual (A70-72) lists the Department's minimum sampling and testing requirements for acceptance for most items of construction. Acceptance of the item in this case means that before the Department can approve payment for the item, the samples and tests must be completed at the required frequency, with results reasonably conforming to the applicable specification. The act of "accepting" an item may be thought of as "paying" for the item. To pay for the item, a certain number of tests must have been performed.

In the past there was no requirement for the contractor to take any samples. The Department took all samples at the required frequency for acceptance of the material. With the adoption of MP700.00.54, the Department was freed of the responsibility of taking all samples for acceptance of the material. It allowed for samples, called quality control samples, to be taken by the contractor. The contractor's sampling frequency is still the same as that given in the Construction Manual necessary for acceptance of the material. This MP allowed for acceptance of the material based on a comparison of samples taken by the Department and quality control samples taken by the contractor. The Department's samples are called verification samples.

The Department verification samples are used only to accept the results of the contractor quality control samples. The contractor's quality control sample results are then used for acceptance of the material. The Department may also take samples at the same rate given in the Construction Manual thereby matching the contractor sample for sample. In this case the Department could accept the material on the basis of their own sample results.

When the Department uses the contractor's results to satisfy the acceptance requirements, then the Department must be confident that the contractor is sampling and testing in an acceptable manner. There are several ways to do this, such as technician training programs, monitor samples (ML 25), and the comparison procedure mentioned above.

MP 700.00.54 provides a method for the comparison of the contractor's quality control sample results with the Department's verification sample results. Other procedures direct the Department to take verification samples at a frequency of approximately 10 percent of the frequency for sampling given by the Contractor in their Quality Control Plan, and we know now that this frequency is given in the Construction Manual.

The variability generated by up to ten quality control sample results determines an interval in which the verification sample result must fall for each sieve. If the verification sample result falls within this interval the quality control samples would be considered similar to the verification sample. In this case the contractor's samples (up to that point) would be used to satisfy the acceptance criteria, and payment for those quantities represented by the contractor's samples would be authorized.

If, however, the verification sample result falls outside the interval generated by the contractor's samples, then MP 700.00.54 describes certain investigative procedures that must be followed to determine the action to be taken.

By now you may be wondering if it really matters whether the verification sample passes or fails the actual gradation requirements. As far as the comparison procedure is concerned the answer is no. The verification sample, in this case, is used only to verify the results of the contractor.

Note that MP 700.00.54 describes and identifies similarity by using statistical means. That is, the variability of the contractor's own samples determines the intervals used in the comparison. The intervals are not to be confused with the individual sieve tolerances given in the item's gradation requirements. MP 700.00.54 is fundamental to the Department's acceptance program and should be thoroughly understood by both the contractor and the District.

**(This marks the end of Chapter 3 on gradations. Find the answers to the 10 questions on Page 3-92 and mark or highlight the answers for easy retrieval during the written part of the Aggregate Technician Exam.)**

<b>Alternative Sieve Sizes (English)</b>	<b>Standard Sieve Sizes (Metric)</b>	<b>Alternative Sieve Sizes (English)</b>	<b>Standard Sieve Sizes (Metric)</b>
5 in.	125 mm	No. 7	2.80 mm
4.24 in.	106 mm	No. 8	2.36 mm
4 in.	100 mm	No. 10	2.00 mm
3 1/2 in.	90 mm	No. 12	1.70 mm
3 in.	75 mm	No. 14	1.40 mm
2 1/2 in.	63 mm	No. 16	1.18 mm
2.12 in.	53 mm	No. 18	1.00 mm
2 in.	50 mm	No. 20	850 μm
1 3/4 in.	45 mm	No. 25	710 μm
1 1/2 in.	37.5 mm	No. 30	600 μm
1 1/4 in.	31.5 mm	No. 35	500 μm
1.06 in.	26.5 mm	No. 40	425 μm
1 in.	25.0 mm	No. 45	355 μm
7/8 in.	22.4 mm	No. 50	300 μm
3/4 in.	19.0 mm	No. 60	250 μm
5/8 in.	16.0 mm	No. 70	212 μm
0.530 in.	13.2 mm	No. 80	180 μm
1/2 in.	12.5 mm	No. 100	150 μm
7/16 in.	11.2 mm	No. 120	125 μm
3/8 in.	9.5 mm	No. 140	106 μm
5/16 in.	8.0 mm	No. 170	90 μm
0.265 in.	6.7 mm	No. 200	75 μm
1/4 in.	6.3 mm	No. 230	63 μm
No. 3 1/2	5.6 mm	No. 270	53 μm
No. 4	4.75 mm	No. 325	45 μm
No. 5	4.00 mm	No. 400	38 μm
No. 6	3.35 mm		

### **CHAPTER 3 STUDY QUESTIONS**

1. Sieve analysis is \_\_\_\_\_.
2. Percentages in gradations are always based on the \_\_\_\_\_ of the initial sample.
3. What does the percent passing mean for any sieve?
4. What are some of the things we can do to ensure the sample is being dried properly?
5. What are some conditions which would require the replacement of a sieve?
6. What should you do if you record an error on any worksheet?
7. To what place do you carry out calculations for the coarse aggregate and for the fine aggregate?
8. How much larger is the Field sample than the Test Sample for coarse aggregate?
9. What would you do if, while washing your test sample, you lose some of the sample by spilling the wash water?
10. What is the maximum percentage loss in using the hand sieving method when checking sufficiency of sieving?



**NOTES:**



# CHAPTER 4

## SPECIFIC GRAVITY

### Part I

#### INTRODUCTION

Specific gravity is a property which can be determined for all materials. Specific gravity of a material will be used in many calculations and tests for highway construction materials and is an important property for the aggregate technician to understand.

Simply defined, specific gravity is the number of times heavier a material is than water. Stated another way, it is the ratio of the unit weight of a material to the unit weight of water, rather, the ratio of the density of a material to the density of an equal volume of water. Throughout this manual we will maintain the term "specific gravity" and examine the meaning of its definition further.

Since we have defined specific gravity as the ratio of the density of our material to the density of water, let's practice putting our definition to work.

Suppose we had an object of solid material that was 1 foot by 1 foot by 1 foot; a perfect cube. Suppose we want to measure the specific gravity of the material. We are going to need to measure the density of the material to compare it to the density of water. We will need to find both the mass and volume of the cube. When weighed, we find the material weighs 150 lbs. We can calculate the volume from very precise measurements that we have taken. Remember, volume = length x width x height, so our cube would have a volume of (1ft. x 1ft. x 1ft. = 1 ft.<sup>3</sup>) one cubic foot. Therefore, the density would be:

$$\text{Density} = \frac{\text{Mass}}{\text{Volume}} = \frac{150 \text{ lb.}}{1 \text{ ft.}^3}$$

$$\text{Density} = 150 \text{ lb./ft.}^3$$

Now we have the density of our material. But what about the density of water? Well, here things are made easy for us, as the density of water is a standard for any given temperature and is readily available to us. Let's say that at the temperature at which we are working, we find the **density of water to be 62.4 lb./ft.<sup>3</sup>**. Now, to find the specific gravity of our material we would want to do the following:

Find the ratio of the density of our material to that of water:

$$\begin{aligned}\text{Specific Gravity} &= \frac{\text{Density of Material}}{\text{Density of Water}} \\ &= \frac{150 \text{ lb./ft.}^3}{62.4 \text{ lb./ft.}^3}\end{aligned}$$

Which is correct?

Specific Gravity = 2.40

Specific Gravity = 2.40 lb./ft.<sup>3</sup>

$$\frac{150 \text{ lb./ft.}^3}{62.4 \text{ lb./ft.}^3} = 2.40$$

If we divide lb./ft.<sup>3</sup> by lb./ft.<sup>3</sup> the units cancel, and we are left with a unit-less number.

## PRACTICE PROBLEMS

1. A material weighs 100 lb. and has a volume of 1 ft.<sup>3</sup>. What is its specific gravity?  
Use the density of water as 62.4 lb./ft.<sup>3</sup>

$$\frac{100 \text{ lb./ft.}^3}{62.4 \text{ lb./ft.}^3} = 1.60$$

2. A cube of material is measured and found to have the following dimensions: L = 1.5 ft., w = 1.5 ft., and h = 1.5 ft. Its mass is determined to be 337.5 lb. What is its specific gravity?

(Use the unit weight of water as 62.4 lb./ft.<sup>3</sup>)

$$\begin{aligned} 1.5 \text{ ft.} \times 1.5 \text{ ft.} \times 1.5 \text{ ft.} &= 3.375 \text{ ft.}^3 \\ 337.5 \text{ lb.} \div 3.375 \text{ ft.}^3 &= 100 \text{ lb./ft.}^3 \\ 100 \text{ lb./ft.}^3 \div 62.4 \text{ lb./ft.}^3 &= 1.60 \end{aligned}$$

Now, we have defined specific gravity and have practiced calculating it. Remember, we have said that it is no more than finding the ratio of the density of the material to that of water.

When we begin the determination of specific gravity of an aggregate, however, our procedure is not quite as direct. This stems from the fact that we cannot measure the volume of our aggregate with a ruler or other measuring instrument as we did with a perfect cube of material. As a result, we cannot obtain the density of our material as readily as before. Therefore, we must find a method for determining the volume of our aggregate. Once we do this we can weigh the material. After measuring the material's mass and volume, we can calculate the density.

To determine the volume of our aggregate we make use of a principle deduced by Archimedes around the year 200 B.C. Archimedes Principle states that, "The buoyant force on a submerged object is equal to the weight of the fluid displaced." Therefore, using this principle, if we weigh our aggregate in air and then weigh it immersed in water we will find that it weighs less when immersed in water. This difference will be equal to the buoyant force, which according to Archimedes Principle, will be equal to the mass of the displaced water. Now, common sense tells us that the water displaced had to be displaced by our aggregate. Therefore:

**the volume of displaced water = the volume of the aggregate**

The unit weight of water at various temperatures is a known property, therefore if we know the mass of the water displaced we can easily calculate the volume which was displaced by our aggregate and thus we know its volume. Let's demonstrate by example:

Suppose the difference in weight of our aggregate in air and in water is 10 lb. Knowing at a given temperature, the density of water is 62.4 lb./ft.<sup>3</sup> we may divide to obtain the volume occupied.

$$\frac{10 \text{ lb.}}{62.4 \text{ lb./ft.}^3} = 0.16 \text{ ft.}^3$$

The volume of the material which was immersed in the water was 0.16 ft.<sup>3</sup>. If we measure the mass of the material in air, we can calculate the density of the material by multiplying the mass by the volume. From here we can calculate its specific gravity like we did before.

Later, as we get into the test procedure and formal calculations of specific gravity, you will find where the things we are learning here are employed. You will see the material weighed in air and then in water. The calculations are set up for us in the test procedure and on the standard work sheet, summarized in a few short steps. However, a thorough understanding of what we do when we conduct a specific gravity test is important.

There are some terms we want to define before we begin examination of the test procedures listed in AASHTO T84 (Specific Gravity and Absorption of Fine Aggregate) and T85 (Specific Gravity and Absorption of Coarse Aggregate).

**Saturated-Surface-Dry:**

One of the terms we wish to define is "saturated-surface-dry" (SSD). This condition of an aggregate is mentioned in both the determination of fine and coarse aggregate specific gravity. The condition of being saturated-surface-dry is when all of the inner pores of an aggregate particle are filled with water and the exterior surface of the aggregate does not have any free moisture. In order to visualize this condition, one might think of a sponge which was allowed to fill with water until all pores were full and the surface did not show evidence of moisture.

A Saturated-Surface-Dry (SSD) Aggregate:

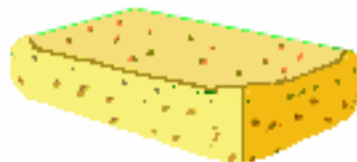

Is Like a Sponge

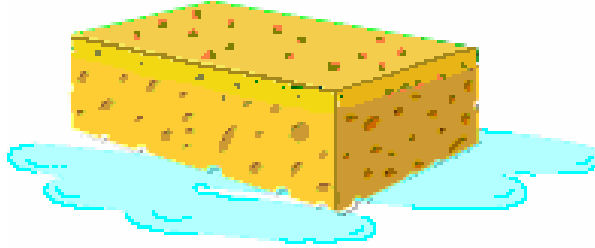

Full of Water.

**Absorption:**

A second term of interest is “absorption”. We will be called upon to determine this value for use in proportioning Portland Cement concrete. Absorption is the amount of moisture which is held within the pores of aggregate when the material is saturated-surface dry. It is the percentage of the dry mass of the material represented by the mass of the moisture in the material’s pores. This can be illustrated as follows:

$$\% \text{ Absorption} = \frac{\text{Mass of Water in Pores}}{\text{Oven Dry Mass of Material}} \times 100$$

It is expressed as a percentage, determined by dividing the mass of moisture in the material by the dry mass of the material. The percent absorption can specifically be determined as follows:

$$\% \text{ Absorption} = \frac{\text{Material Mass (SSD)} - \text{Material Mass (Dry)}}{\text{Material Weight (Dry)}} \times 100$$



In the test procedures (AASHTO T84 and T85), instructions are provided for determining the **bulk specific gravity on an oven-dry basis**, the **bulk specific gravity on a saturated-surface-dry basis**, the **apparent specific gravity**, and **absorption**. We will most often be concerned with the bulk specific gravity on a saturated-surface-dry basis (bulk gravity - SSD basis) and bulk specific gravity on an oven-dry basis. Generally, the bulk gravity - SSD basis and absorption are used in calculations concerning Portland Cement Concrete mix designs.

Now let's look at the actual test procedures. The Standard Method of Test for Specific Gravity and Absorption of Fine Aggregate is AASHTO T84. Read this method over carefully before continuing.

## PART II

### BULK SPECIFIC GRAVITY OF FINE AGGREGATE

After studying AASHTO T84, let's make a list of the materials and equipment we will need to run a test:

1. A sample of fine aggregate large enough to furnish approximately 1000 g for a test portion.
2. Suitable pans for holding the test portions.
3. A sample splitter.
4. An oven capable of maintaining a temperature of  $230 \pm 9^{\circ}\text{F}$  ( $110 \pm 5^{\circ}\text{C}$ ).
5. Fan or blow dryer for bringing the test portion to a saturated-surface-dry condition.
6. The standard sand cone and tamper.
7. A 500ml calibrated pycnometer.
8. A balance conforming to the requirements of the specifications.
9. Distilled water for filling the pycnometer.
10. Isopropyl alcohol for dispensing foam.
11. Thermometer which can be read or interpolated to  $0.2^{\circ}\text{F}$  ( $0.1^{\circ}\text{C}$ ).
12. A funnel and spoon to get the sand into the pycnometer.
13. A T305 worksheet for recording data and calculating the results.

The form used in conducting the Bulk Specific Gravity of Fine Aggregate is the T305. A copy of this form can be seen on page 4-18. First, we must enter the proper identification information at the top of the T305.

We are now ready to start the test. The first step is to split and dry a test portion. Using the sample splitter, obtain a test portion of approximately 1000g from the field sample. Place the test portion in a pan and dry it in the oven at  $230 \pm 9^{\circ}\text{F}$  ( $110 \pm 5^{\circ}\text{C}$ ) until it reaches a constant weight. This initial drying is important if uniform results are to be obtained, because it assures that all test portions start in exactly the same condition. If you have not already done so, you

can determine the mass of the pycnometer filled with distilled water while the test portion dries. To do this, fill a dry pycnometer to its calibration mark with distilled water at a temperature of  $73.4 \pm 3^{\circ}\text{F}$  ( $23 \pm 1.7^{\circ}\text{C}$ ) and weigh it to the nearest 0.1g. This measurement should be recorded in the "B = Mass of pycnometer filled to calibration mark with distilled water, grams" space on the T305. This value, the pycnometer calibration mass, may also be recorded on the pycnometer for future reference. It is not necessary to measure mass of the pycnometer each time a test is made, since it should not change. Good laboratory practice would indicate that a recheck every three months is sufficient, unless some difficulty is encountered in the meantime.

Why do we specify distilled water to fill the pycnometer? You probably do not recall seeing distilled water mentioned in the test method. We must refer to ASTM E1547 which says: "*Specific Gravity is the ratio of the mass of a unit volume of a material at a stated temperature to the mass of the same volume of **gas-free distilled water at a stated temperature.***" From this definition we can see that it is necessary to use distilled water in the pycnometer.

After the test portion dries to constant mass, it is removed from the oven and cooled to room temperature. After cooling, cover it completely with water (this may be tap water) and allow to soak for 15 to 19 hours. Another option is to use the 6% method, where you add 6% moisture to your sample and cover for 15 to 19 hours.

At the end of the soaking period we must bring the material to a SSD condition. The excess water is removed by decanting (pouring), taking care not to lose any of the fines. Spread the material out on a flat, non-absorbent surface and stir frequently. A fan or blow dryer may be used to speed drying but should not be pointed directly at the sample. This could result in uneven drying and loss of fines. Stir frequently and continue drying until the material approaches a free-flowing condition. To determine when the material is at SSD condition, we use a specially constructed mold and tamper as shown on the next page:

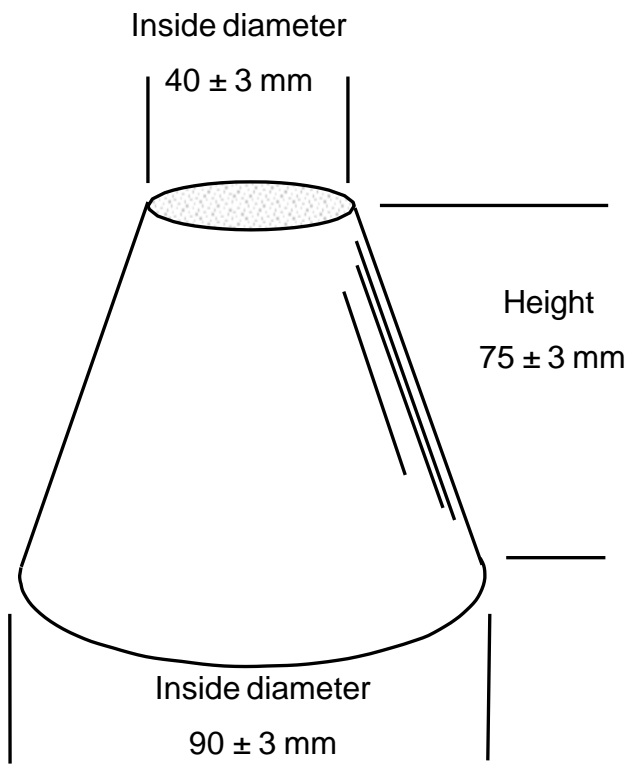

Mold and Tamper.

At this point, you begin checking the aggregate condition with the cone and tamper. Hold the cone firmly on a smooth clean surface with the large end down. Fill the cone loosely with material to overflowing by cupping the fingers of the hand holding the cone around and over the top of the cone. Carefully remove cupped hand, while holding downward pressure on the cone with the other hand. Lightly tamp the surface of the aggregate twenty-five times with the tamper. Start the tamper with the bottom approximately 0.2 in. (5 mm) above the surface of the fine aggregate and allow the tamper to drop freely, being careful not to add force to, or retard the fall. This takes some practice. Adjust the starting height of each blow of the tamper to the highest point of the new aggregate surface which lies directly under the tamper. Immediately after tamping, brush the loose sand from around the cone base, taking care to keep constant, downward pressure on the cone. When the material is brushed away from around the base of the cone, carefully lift the cone. If there is still free moisture on the material's surface, it will cause the particles to adhere to one another and retain shape of the cone (no slump). We must have at least one trial that does not slump before obtaining one that does. If the material slumps on the first trial, there is no way to confirm that the sample has just reached the SSD condition. We must add a few milliliters of water, thoroughly mix the material and water, then cover and allow to stand 30 minutes before beginning drying process again.

Before the drying process, you will want to pour a small amount of distilled water into the pycnometer to reduce the amount of entrapped air when the SSD sample is introduced. Continue drying and testing with the cone until the material slumps slightly when the cone is lifted. This indicates a saturated-surface-dry condition.

Working quickly, weigh approximately  $500\text{g} \pm 10\text{g}$  of the SSD material and record this mass to the nearest 0.1g in the "D = Mass of saturated-surface-dry sample in air, grams" space on the T305. Quickly introduce this material into the partially filled pycnometer using a funnel to ensure no loss of material. Be sure to rinse any remaining sample from the funnel into the pycnometer. If you delay at this point, the material will continue to dry past SSD condition. Immediately after introducing the material, fill the pycnometer about 90%

full of distilled water (**the water level should be just into the base of the neck**). Manually roll, invert and agitate the pycnometer to remove all air bubbles. This may take 15-20 minutes. It is very important that all the air is eliminated, so do a thorough job. We know that the air has been removed when there are no air bubbles seen coming out of the aggregate during agitation. After you are sure all the air is removed, adjust the temperature of the contents of the pycnometer to  $73.4 \pm 3^\circ\text{F}$  ( $23 \pm 1.7^\circ\text{C}$ ). You may have to place the pycnometer in a water bath until the pycnometer and its contents stabilize at this temperature. Be sure to rinse any material off the thermometer into the pycnometer.

When the correct temperature is obtained, any foam floating on the surface may be dispensed by the addition of isopropyl alcohol (a few drops will do). The foam may also be removed with a paper towel. Roll the towel, insert it into the neck of the pycnometer, allowing the foam to be absorbed. Take care not to allow any of the sample to be absorbed into the towel. Once the foam and air have been removed, finish filling the pycnometer to the calibration mark with distilled water. The water level should be adjusted so that the bottom of the meniscus is on the calibration mark as shown below.

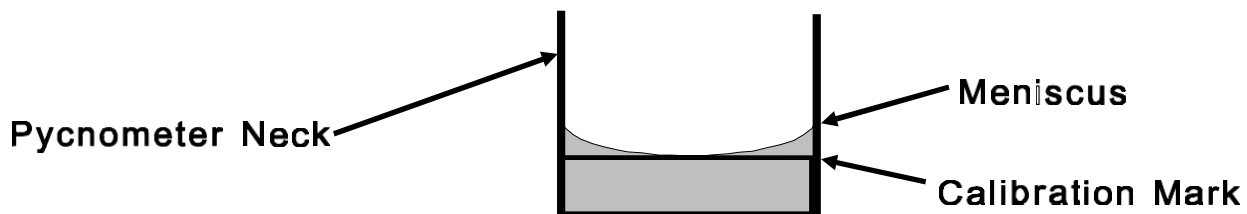

The pycnometer should then be weighed, and the mass recorded to the nearest 0.1g in the “C = Mass of pycnometer, sample, and water to the calibration mark, grams” space on the T305.

Next, a clean, empty drying pan of sufficient size for containing all of the sample and water should be weighed and the mass recorded in the “(b) Mass of drying pan, grams” space on the T305. Pour the contents of the pycnometer into the pan, taking care not to lose any

material. Thoroughly wash all material out of the pycnometer. This may be done with tap water. Dry to a constant mass in an oven at  $230 \pm 9^\circ\text{F}$  ( $110 \pm 5^\circ\text{C}$ ), cool in air at room temperature for  $1 \pm 1/2$  hour and weigh to the nearest 0.1g. This mass should be recorded in the “(a) Mass of oven-dry sample and drying pan in air, grams” space on the T305. The Mass of the oven dry sample in air can be determined at this time by subtracting the mass of the drying pan from the mass of the oven dry sample and drying pan in air ( (a)-(b) ). This answer should be recorded in the “A = Mass of oven-dry sample in air, grams” space on the T305.

You should now have following weights recorded on the following lines on the T305 form, all in grams:

- (A) The mass of the oven dry sample in air.
- (a) The mass of the oven-dry sample and drying pan in air.
- (b) The mass of the drying pan.
- (B) The mass of the pycnometer filled with distilled water.
- (C) The mass of the pycnometer, sample, and water.
- (D) The mass of the saturated-surface-dry sample in air.

**Note:** Letters correspond to actual line designations on the T305

With these numbers, we can calculate any type of specific gravity or absorption we would normally need for highway use. Using the letter designations, we can set up formulas as follows:

$$\text{Weight of the oven-dry sample in air} = (a) - (b)$$

$$\text{Bulk Specific Gravity (Oven-dry basis)} = \frac{A}{B + D - C}$$

$$\text{Bulk Specific Gravity (SSD Basis)} = \frac{D}{B + D - C}$$

$$\text{Apparent Specific Gravity (Oven-dry basis)} = \frac{A}{B + A - C}$$

$$\text{Absorption, percent} = \frac{D - A}{A} \times 100$$

Let's assume we have completed a test and have the following data:

(a) = Oven dry mass of sample and drying pan in air, g	= 539.9 g
(b) = Mass of drying pan, g	= 55.2 g
B = Mass of pycnometer and distilled water, g	= 635.0 g
C = Mass of pycnometer, sample, and water, g	= 945.0 g
D = SSD mass of test portion in air, g	= 510.0 g

Using the form T305 on page 4-15, calculate the Bulk Specific Gravity Oven-Dry, SSD, Apparent Specific Gravity and the Absorption according to the procedure to the following accuracies:

- |                       |               |
|-----------------------|---------------|
| 1. Mass               | Nearest 0.1 g |
| 2. Specific Gravities | Nearest 0.01  |
| 3. Absorption         | Nearest 0.1%  |

Answers found on page 4-16.



T305  
Rev.12-01

WEST VIRGINIA DIVISION OF HIGHWAYS  
MATERIALS CONTROL, SOILS AND TESTING DIVISION

BULK SPECIFIC GRAVITY AND ABSORPTION  
FINE AGGREGATE

Laboratory No. \_\_\_\_\_

Field Sample No. \_\_\_\_\_

Date \_\_\_\_\_

Source \_\_\_\_\_

Tested By \_\_\_\_\_

(Record masses to 0.1 g)

A = Mass of oven-dry sample in air, grams ((a)-(b)) \_\_\_\_\_

(a) Mass of oven-dry sample  
and drying pan in air, grams \_\_\_\_\_

(b) Mass of drying pan, grams \_\_\_\_\_

B = Mass of pycnometer filled to calibration mark with  
distilled water, grams \_\_\_\_\_

C = Mass of pycnometer, sample, and water to calibration  
mark, grams \_\_\_\_\_

D = Mass of saturated-surface-dry sample in air, grams \_\_\_\_\_

Bulk Specific Gravity (Oven Dry Basis) =  $\frac{A}{B+D-C}$  = \_\_\_\_\_

Bulk Specific Gravity (Saturated-Surface-Dry Basis) =  $\frac{D}{B+D-C}$  = \_\_\_\_\_

Apparent Specific Gravity =  $\frac{A}{B+A-C}$  = \_\_\_\_\_

Absorption, percent =  $\frac{D-A}{A} \times 100$  = \_\_\_\_\_

Report Specific Gravities to the nearest 0.01

Report Absorption to the nearest 0.1%

T305  
Rev.12-01

WEST VIRGINIA DIVISION OF HIGHWAYS  
MATERIALS CONTROL, SOILS AND TESTING DIVISION

BULK SPECIFIC GRAVITY AND ABSORPTION  
FINE AGGREGATE

Laboratory No. \_\_\_\_\_

Field Sample No. \_\_\_\_\_

Date \_\_\_\_\_

Source \_\_\_\_\_

Tested By \_\_\_\_\_

(Record masses to 0.1 g)

A = Mass of oven-dry sample in air, grams ((a)-(b)) 539.9 - 55.2 = 484.7

(a) Mass of oven-dry sample  
and drying pan in air, grams 539.9

(b) Mass of drying pan, grams 55.2

B = Mass of pycnometer filled to calibration mark with  
distilled water, grams 635.0

C = Mass of pycnometer, sample, and water to calibration  
mark, grams 945.0

D = Mass of saturated-surface-dry sample in air, grams 510.0

Bulk Specific Gravity (Oven Dry Basis) =  $\frac{A}{B+D-C} = \frac{484.7}{(635.0 + 510.0 - 945.0) = 200.0} = 484.7 = 2.42$

Bulk Specific Gravity (Saturated-Surface-Dry Basis) =  $\frac{D}{B+D-C} = \frac{510.0}{(635.0 + 510.0 - 945.0) = 200.0} = 510.0 = 2.55$

Apparent Specific Gravity =  $\frac{A}{B+A-C} = \frac{484.7}{(635.0 + 484.7 - 945.0) = 174.7} = 484.7 = 2.77$

Absorption, percent =  $\frac{D-A}{A} \times 100 = \frac{(510.0 - 484.7)}{484.7} = \frac{25.3}{484.7} = 0.052 \times 100 = 5.2\%$

Report Specific Gravities to the nearest 0.01

Report Absorption to the nearest 0.1%

After studying the calculations on the preceding example until you understand them, you may now work the following example problems, using the data in the table and the blank T305 forms on the following pages.

Find the Bulk Specific Gravity Oven Dry, SSD, Apparent Specific Gravity, and the Percent Absorption.

Fine Agg. Sample No.	O. D. Mass of sample and pan (a)	Mass of Pan (b)	Mass of Pycn. & distilled water (B)	Mass of Pycn., Fine Agg & water (C)	SSD mass In Air (D)
1	550.2	52.2	675.4	984.1	500.0
2	544.8	54.8	675.4	995.4	500.0
3	552.8	51.6	683.1	972.3	505.1
4	541.5	50.0	662.6	975.7	495.5
5	547.8	51.4	675.4	995.4	510.3

The answers to the above problems are found at the end of the Chapter. Check your answers and continue to the next portion of your assignment.

T305  
Rev.12-01

WEST VIRGINIA DIVISION OF HIGHWAYS  
MATERIALS CONTROL, SOILS AND TESTING DIVISION

BULK SPECIFIC GRAVITY AND ABSORPTION  
FINE AGGREGATE

Laboratory No. \_\_\_\_\_

Field Sample No. \_\_\_\_\_

Date \_\_\_\_\_

Source \_\_\_\_\_

Tested By \_\_\_\_\_

(Record masses to 0.1 g)

A = Mass of oven-dry sample in air, grams ((a)-(b)) \_\_\_\_\_

(a) Mass of oven-dry sample  
and drying pan in air, grams \_\_\_\_\_

(b) Mass of drying pan, grams \_\_\_\_\_

B = Mass of pycnometer filled to calibration mark with  
distilled water, grams \_\_\_\_\_

C = Mass of pycnometer, sample, and water to calibration  
mark, grams \_\_\_\_\_

D = Mass of saturated-surface-dry sample in air, grams \_\_\_\_\_

Bulk Specific Gravity (Oven Dry Basis) =  $\frac{A}{B+D-C}$  = \_\_\_\_\_

Bulk Specific Gravity (Saturated-Surface-Dry Basis) =  $\frac{D}{B+D-C}$  = \_\_\_\_\_

Apparent Specific Gravity =  $\frac{A}{B+A-C}$  = \_\_\_\_\_

Absorption, percent =  $\frac{D-A}{A} \times 100$  = \_\_\_\_\_

Report Specific Gravities to the nearest 0.01

Report Absorption to the nearest 0.1%

T305  
Rev.12-01

WEST VIRGINIA DIVISION OF HIGHWAYS  
MATERIALS CONTROL, SOILS AND TESTING DIVISION

BULK SPECIFIC GRAVITY AND ABSORPTION  
FINE AGGREGATE

Laboratory No. \_\_\_\_\_

Field Sample No. \_\_\_\_\_

Date \_\_\_\_\_

Source \_\_\_\_\_

Tested By \_\_\_\_\_

(Record masses to 0.1 g)

A = Mass of oven-dry sample in air, grams ((a)-(b)) \_\_\_\_\_

(a) Mass of oven-dry sample  
and drying pan in air, grams \_\_\_\_\_

(b) Mass of drying pan, grams \_\_\_\_\_

B = Mass of pycnometer filled to calibration mark with  
distilled water, grams \_\_\_\_\_

C = Mass of pycnometer, sample, and water to calibration  
mark, grams \_\_\_\_\_

D = Mass of saturated-surface-dry sample in air, grams \_\_\_\_\_

Bulk Specific Gravity (Oven Dry Basis) =  $\frac{A}{B+D-C}$  = \_\_\_\_\_

Bulk Specific Gravity (Saturated-Surface-Dry Basis) =  $\frac{D}{B+D-C}$  = \_\_\_\_\_

Apparent Specific Gravity =  $\frac{A}{B+A-C}$  = \_\_\_\_\_

Absorption, percent =  $\frac{D-A}{A} \times 100$  = \_\_\_\_\_

Report Specific Gravities to the nearest 0.01

Report Absorption to the nearest 0.1%

WEST VIRGINIA DIVISION OF HIGHWAYS  
MATERIALS CONTROL, SOILS AND TESTING DIVISION

BULK SPECIFIC GRAVITY AND ABSORPTION  
FINE AGGREGATE

Laboratory No. \_\_\_\_\_

Field Sample No. \_\_\_\_\_

Date \_\_\_\_\_

Source \_\_\_\_\_

Tested By \_\_\_\_\_

(Record masses to 0.1 g)

A = Mass of oven-dry sample in air, grams ((a)-(b)) \_\_\_\_\_

(a) Mass of oven-dry sample  
and drying pan in air, grams \_\_\_\_\_

(b) Mass of drying pan, grams \_\_\_\_\_

B = Mass of pycnometer filled to calibration mark with  
distilled water, grams \_\_\_\_\_

C = Mass of pycnometer, sample, and water to calibration  
mark, grams \_\_\_\_\_

D = Mass of saturated-surface-dry sample in air, grams \_\_\_\_\_

$$\text{Bulk Specific Gravity (Oven Dry Basis)} = \frac{A}{B+D-C} = \underline{\hspace{2cm}}$$

$$\text{Bulk Specific Gravity (Saturated-Surface-Dry Basis)} = \frac{D}{B+D-C} = \underline{\hspace{2cm}}$$

$$\text{Apparent Specific Gravity} = \frac{A}{B+A-C} = \underline{\hspace{2cm}}$$

$$\text{Absorption, percent} = \frac{D-A}{A} \times 100 = \underline{\hspace{2cm}}$$

Report Specific Gravities to the nearest 0.01

Report Absorption to the nearest 0.1%

T305  
Rev.12-01

WEST VIRGINIA DIVISION OF HIGHWAYS  
MATERIALS CONTROL, SOILS AND TESTING DIVISION

BULK SPECIFIC GRAVITY AND ABSORPTION  
FINE AGGREGATE

Laboratory No. \_\_\_\_\_

Field Sample No. \_\_\_\_\_

Date \_\_\_\_\_

Source \_\_\_\_\_

Tested By \_\_\_\_\_

(Record masses to 0.1 g)

A = Mass of oven-dry sample in air, grams ((a)-(b)) \_\_\_\_\_

(a) Mass of oven-dry sample  
and drying pan in air, grams \_\_\_\_\_

(b) Mass of drying pan, grams \_\_\_\_\_

B = Mass of pycnometer filled to calibration mark with  
distilled water, grams \_\_\_\_\_

C = Mass of pycnometer, sample, and water to calibration  
mark, grams \_\_\_\_\_

D = Mass of saturated-surface-dry sample in air, grams \_\_\_\_\_

Bulk Specific Gravity (Oven Dry Basis) =  $\frac{A}{B+D-C}$  = \_\_\_\_\_

Bulk Specific Gravity (Saturated-Surface-Dry Basis) =  $\frac{D}{B+D-C}$  = \_\_\_\_\_

Apparent Specific Gravity =  $\frac{A}{B+A-C}$  = \_\_\_\_\_

Absorption, percent =  $\frac{D-A}{A} \times 100$  = \_\_\_\_\_

Report Specific Gravities to the nearest 0.01

Report Absorption to the nearest 0.1%

T305  
Rev.12-01

WEST VIRGINIA DIVISION OF HIGHWAYS  
MATERIALS CONTROL, SOILS AND TESTING DIVISION

BULK SPECIFIC GRAVITY AND ABSORPTION  
FINE AGGREGATE

Laboratory No. \_\_\_\_\_

Field Sample No. \_\_\_\_\_

Date \_\_\_\_\_

Source \_\_\_\_\_

Tested By \_\_\_\_\_

(Record masses to 0.1 g)

A = Mass of oven-dry sample in air, grams ((a)-(b)) \_\_\_\_\_

(a) Mass of oven-dry sample  
and drying pan in air, grams \_\_\_\_\_

(b) Mass of drying pan, grams \_\_\_\_\_

B = Mass of pycnometer filled to calibration mark with  
distilled water, grams \_\_\_\_\_

C = Mass of pycnometer, sample, and water to calibration  
mark, grams \_\_\_\_\_

D = Mass of saturated-surface-dry sample in air, grams \_\_\_\_\_

Bulk Specific Gravity (Oven Dry Basis) =  $\frac{A}{B+D-C}$  = \_\_\_\_\_

Bulk Specific Gravity (Saturated-Surface-Dry Basis) =  $\frac{D}{B+D-C}$  = \_\_\_\_\_

Apparent Specific Gravity =  $\frac{A}{B+A-C}$  = \_\_\_\_\_

Absorption, percent =  $\frac{D-A}{A} \times 100$  = \_\_\_\_\_

Report Specific Gravities to the nearest 0.01

Report Absorption to the nearest 0.1%



## Part III

### BULK SPECIFIC GRAVITY OF COARSE AGGREGATE

The Standard Method of Test for Specific Gravity and Absorption of Coarse Aggregate is AASHTO T85. You should read the test method carefully before continuing.

\*\*\*\*\*

From the test method, it is determined that the following materials and equipment are required to conduct the test:

1. A sample of coarse aggregate depending on the nominal maximum size per Section 7.3 of AASHTO T85, reproduced on page 4-24.
2. A sample splitter.
3. A No. 4 (4.75 mm) screen to remove the fines.
4. A means of washing sample to remove coatings.
5. An oven capable of maintaining a temperature of  $230 \pm 9^{\circ}\text{F}$  ( $110 \pm 5^{\circ}\text{C}$ ).
6. A balance having a capacity of 5000g or more.
7. Sample containers, both pans and a wire basket, for weighing in air and water.
8. A water tank into which the sample is placed while suspended below the balance, equipped with an overflow outlet for maintaining a constant water level.
9. A thermometer that can be read or interpolated to  $0.2^{\circ}\text{F}$  ( $0.1^{\circ}\text{C}$ ) to check water temperature.
10. A large absorbent cloth for drying the aggregate to a surface-dry condition.
11. A T306 worksheet for recording weights and calculating results. A copy of this form can be seen on page 4-28.

First, use the sample splitter to obtain an approximate test portion from the field sample. Minimum test portions, based on nominal maximum size, can be seen in the table on the next page. The test portion is dry sieved over the No. 4 (4.75 mm) sieve and all material passing is discarded. Thoroughly wash the test portion to remove all coatings. Dry the test portion to constant mass at  $230 \pm 9^{\circ}\text{F}$  ( $110 \pm 5^{\circ}\text{C}$ ). This initial drying is important to ensure

that all samples start soaking in the same condition. Cool in air at room temperature for 1 to 3 hours. For larger size aggregates, greater than 1 1/2 inch nominal maximum size, cool for a longer period to a temperature that is comfortable to handle (approx. 122 °F or 50 °C). Then immerse in tap water at room temperature for 15 to 19 hours.

**MINIMUM TEST WEIGHTS FOR COARSE SPECIFIC GRAVITY**

<b>Nominal Maximum Size</b>		<b>Minimum Weight of Test Sample</b>	
<b>inches</b>	<b>(mm)</b>	<b>pounds</b>	<b>(kg)</b>
<b>1/2</b>	<b>(12.5) or less</b>	<b>4.4</b>	<b>(2)</b>
<b>3/4</b>	<b>(19.0)</b>	<b>6.6</b>	<b>(3)</b>
<b>1</b>	<b>(25.0)</b>	<b>8.8</b>	<b>(4)</b>
<b>1 1/2</b>	<b>(37.5)</b>	<b>11</b>	<b>(5)</b>
<b>2</b>	<b>(50)</b>	<b>18</b>	<b>(8)</b>
<b>2 1/2</b>	<b>(63)</b>	<b>26</b>	<b>(12)</b>
<b>3</b>	<b>(75)</b>	<b>40</b>	<b>(18)</b>
<b>3 1/2</b>	<b>(90)</b>	<b>55</b>	<b>(25)</b>
<b>4</b>	<b>(100)</b>	<b>88</b>	<b>(40)</b>
<b>4 1/2</b>	<b>(112)</b>	<b>110</b>	<b>(50)</b>
<b>5</b>	<b>(125)</b>	<b>165</b>	<b>(75)</b>
<b>6</b>	<b>(150)</b>	<b>276</b>	<b>(125)</b>

At the end of the soaking period, assemble the equipment for obtaining the necessary weights. There are several procedures which will give satisfactory results, but the one outlined here is believed to be the simplest and least likely to result in errors.

A 5000g digital balance is generally used for this test. These balances have provisions for attaching a wire underneath the balance. Position the balance on a table over a drilled hole in the table top so that a wire can be attached to the bottom of the balance and extend

down under the table. Place a container full of water adjusted to  $73.4 \pm 3^{\circ}\text{F}$  ( $23 \pm 1.7^{\circ}\text{C}$ ) under the table. The container must have an overflow pipe so that the same constant water level can be achieved throughout the test. In routine testing use tap water rather than distilled water. In a referee test where ultimate accuracy would be required, it would be necessary to use distilled water. The wire will be used to suspend a wire basket in the container of water and shall be of the smallest practical diameter to minimize any possible effects of a variable immersed length. The wire must be freely suspended, not touching the sides of the hole in the table and be positioned so that the basket can be completely submerged. The wire or basket must not touch the sides or bottom of the container. If the wire basket is not completely submerged, including the bail, the results will be invalid. The wire basket must have a wire mesh of No. 6 (3.35 mm) or smaller, and the size of the basket must meet size requirements of paragraph 6.2 of T 85. Place an empty pan on the balance to be used in weighing the test portion in air.

The equipment should now be set up; the weighing pan on the balance and the empty wire basket suspended in water. Fill the water container until water flows out of the overflow. Wait until water flowing out of the overflow slows to a drip and the weight of the basket shows no significant change. Now zero the balance. The entire system is tared, and the mass of the pan and wire basket is now disregarded. All masses recorded will be direct readings of the test portion.

The aggregate sample is now ready to be brought to SSD for weighing. Decant the soaking water and place the aggregate on the large absorbent cloth. Dry just until the sheen disappears from the surface of the aggregate particles. At a saturated surface dry condition, the particles should look slightly damp, but not shiny. This operation must be done quickly, using care not to permit some particles to over-dry while drying the entire sample. To avoid uneven drying, the sample may be dried in increments. A damp towel may be placed over the SSD aggregate in another container to maintain its condition.

**Immediately** upon completion of drying the entire test portion to a SSD condition, place the test portion in the tared pan on the balance (tared as described above) and weigh in air. Record this mass to the nearest 1g in the “B = Mass of saturated-surface-dry sample in air, grams” space on the T306.

Quickly transfer the test portion to the wire basket, taking care not to lose any material, and replace the empty tared pan on the scale. Place the wire basket in the container of water and hang it on the suspending wire. Shake the basket as it is being submerged to be sure all air is removed. Wait until water flowing out of the overflow slows to a drip as before and the balance shows no significant change. Record this mass to the nearest 1g in the “C = Mass of saturated sample in water, grams” space on the T306.

Remove the test portion from the wire basket, dry to a constant mass at  $230 \pm 9^{\circ}\text{F}$  ( $110 \pm 5^{\circ}\text{C}$ ), cool in air at room temperature 1 to 3 hours or until the aggregate has cooled to a temperature that is comfortable to handle (approx.  $122^{\circ}\text{F}$  or  $50^{\circ}\text{C}$ ) and weigh to the nearest 1g. Record this reading in the “A = Mass of oven-dry sample in air, grams” space on the T306. All three measurements must be taken from the same balance, under the same conditions. This requires the setup be tared with the water at the proper level and temperature, and with the tare pan and basket in place.

There should be three readings now. These measurements are used to calculate all values of specific gravity and absorption.

- A. Mass of oven-dry sample in air, grams.
- B. Mass of saturated-surface-dry sample in air, grams.
- C. Mass of saturated sample in water, grams.

Formulas to be used are as follows:

$$\text{Bulk Specific Gravity (Oven-dry Basis)} = \frac{A}{B-C}$$

$$\text{Bulk Specific Gravity (SSD Basis)} = \frac{B}{B-C}$$

$$\text{Apparent Specific Gravity} = \frac{A}{A-C}$$

$$\text{Absorption, percent} = \frac{B-A}{A} \times 100$$

Let us now complete the calculations for a test, assuming we have obtained the following data:

Mass of Oven Dry Sample ..... 4924 g  
SSD Weight..... 5000 g  
Mass of Sample in Water ..... 3000 g

Find:

Bulk Specific Gravity (Oven Dry)  
Bulk Specific Gravity (SSD)  
Apparent Specific Gravity  
% Absorption

See the next page for solution.

The following reporting accuracies are required for the coarse specific gravity procedure:

1. Mass                                      Nearest 1g
2. Specific Gravities                      Nearest 0.01
3. Absorption                                Nearest 0.1%

T306  
Rev.12-01

WEST VIRGINIA DIVISION OF HIGHWAYS  
MATERIALS CONTROL, SOILS AND TESTING DIVISION

BULK SPECIFIC GRAVITY AND ABSORPTION  
COARSE AGGREGATE

Laboratory No. \_\_\_\_\_

Field Sample No. \_\_\_\_\_

Date \_\_\_\_\_

Source \_\_\_\_\_

Tested By \_\_\_\_\_

(Record masses to 1 g)

A = Mass of oven-dry sample in air, grams \_\_\_\_\_ 4924

B = Mass of saturated-surface-dry sample in air, grams \_\_\_\_\_ 5000

C = Mass of saturated sample in water, grams \_\_\_\_\_ 3000

$$\text{Bulk Specific Gravity (Oven Dry Basis)} = \frac{A}{B-C} = \frac{4924}{(5000 - 3000)} = \frac{4924}{2000} = 2.46$$

$$\text{Bulk Specific Gravity (Saturated-Surface-Dry Basis)} = \frac{B}{B-C} = \frac{5000}{(5000 - 3000)} = \frac{5000}{2000} = 2.50$$

$$\text{Apparent Specific Gravity} = \frac{A}{A-C} = \frac{4924}{(4924 - 3000)} = \frac{4924}{1924} = 2.56$$

$$\text{Absorption, percent} = \frac{B-A}{A} \times 100 = \frac{(5000 - 4924)}{4924} \times 100 = \frac{76}{4924} \times 100 = 1.5\%$$

Report Specific Gravities to the nearest 0.01  
Report Absorption to the nearest 0.1%

Now that you have worked through the example, let's work the following practice problems; calculate the Bulk Specific Gravity Oven Dry, SSD, Apparent Specific Gravity, and the Percent Absorption.

Coarse Agg. Sample No.	Oven Dry Mass (g) in Air (A)	SSD Mass (g) in Air (B)	SSD Mass (g) in Water (C)
1	4900	5100	3000
2	4950	5200	3050
3	5019	5324	3137
4	4851	5057	2712
5	4912	5042	2704

Answers will be found at the end of the Chapter.

T306  
Rev.12-01

WEST VIRGINIA DIVISION OF HIGHWAYS  
MATERIALS CONTROL SOILS & TESTING DIVISION

BULK SPECIFIC GRAVITY AND ABSORPTION  
COARSE AGGREGATE

Laboratory No. \_\_\_\_\_

Field Sample No. \_\_\_\_\_

Date \_\_\_\_\_

Source \_\_\_\_\_

Tested By \_\_\_\_\_

(Record masses to 1 g)

A = Mass of oven-dry sample in air, grams \_\_\_\_\_

B = Mass of saturated-surface-dry sample in air, grams \_\_\_\_\_

C = Mass of saturated sample in water, grams \_\_\_\_\_

Bulk Specific Gravity (Oven Dry Basis) =  $\frac{A}{B-C}$  = \_\_\_\_\_

Bulk Specific Gravity (Saturated-Surface-Dry Basis) =  $\frac{B}{B-C}$  = \_\_\_\_\_

Apparent Specific Gravity =  $\frac{A}{A-C}$  = \_\_\_\_\_

Absorption, percent =  $\frac{B-A}{A} \times 100$  = \_\_\_\_\_

Report Specific Gravities to the nearest 0.01  
Report Absorption to the nearest 0.1%



T306  
Rev.12-01

WEST VIRGINIA DIVISION OF HIGHWAYS  
MATERIALS CONTROL SOILS & TESTING DIVISION

BULK SPECIFIC GRAVITY AND ABSORPTION  
COARSE AGGREGATE

Laboratory No. \_\_\_\_\_

Field Sample No. \_\_\_\_\_

Date \_\_\_\_\_

Source \_\_\_\_\_

Tested By \_\_\_\_\_

(Record masses to 1 g)

A = Mass of oven-dry sample in air, grams \_\_\_\_\_

B = Mass of saturated-surface-dry sample in air, grams \_\_\_\_\_

C = Mass of saturated sample in water, grams \_\_\_\_\_

Bulk Specific Gravity (Oven Dry Basis) =  $\frac{A}{B-C}$  = \_\_\_\_\_

Bulk Specific Gravity (Saturated-Surface-Dry Basis) =  $\frac{B}{B-C}$  = \_\_\_\_\_

Apparent Specific Gravity =  $\frac{A}{A-C}$  = \_\_\_\_\_

Absorption, percent =  $\frac{B-A}{A} \times 100$  = \_\_\_\_\_

Report Specific Gravities to the nearest 0.01  
Report Absorption to the nearest 0.1%

T306  
Rev.12-01

WEST VIRGINIA DIVISION OF HIGHWAYS  
MATERIALS CONTROL SOILS & TESTING DIVISION

BULK SPECIFIC GRAVITY AND ABSORPTION  
COARSE AGGREGATE

Laboratory No. \_\_\_\_\_

Field Sample No. \_\_\_\_\_

Date \_\_\_\_\_

Source \_\_\_\_\_

Tested By \_\_\_\_\_

(Record masses to 1 g)

A = Mass of oven-dry sample in air, grams \_\_\_\_\_

B = Mass of saturated-surface-dry sample in air, grams \_\_\_\_\_

C = Mass of saturated sample in water, grams \_\_\_\_\_

Bulk Specific Gravity (Oven Dry Basis) =  $\frac{A}{B-C}$  = \_\_\_\_\_

Bulk Specific Gravity (Saturated-Surface-Dry Basis) =  $\frac{B}{B-C}$  = \_\_\_\_\_

Apparent Specific Gravity =  $\frac{A}{A-C}$  = \_\_\_\_\_

Absorption, percent =  $\frac{B-A}{A} \times 100$  = \_\_\_\_\_

Report Specific Gravities to the nearest 0.01  
Report Absorption to the nearest 0.1%

T306  
Rev.12-01

WEST VIRGINIA DIVISION OF HIGHWAYS  
MATERIALS CONTROL SOILS & TESTING DIVISION

BULK SPECIFIC GRAVITY AND ABSORPTION  
COARSE AGGREGATE

Laboratory No. \_\_\_\_\_

Field Sample No. \_\_\_\_\_

Date \_\_\_\_\_

Source \_\_\_\_\_

Tested By \_\_\_\_\_

(Record masses to 1 g)

A = Mass of oven-dry sample in air, grams \_\_\_\_\_

B = Mass of saturated-surface-dry sample in air, grams \_\_\_\_\_

C = Mass of saturated sample in water, grams \_\_\_\_\_

Bulk Specific Gravity (Oven Dry Basis) =  $\frac{A}{B-C}$  = \_\_\_\_\_

Bulk Specific Gravity (Saturated-Surface-Dry Basis) =  $\frac{B}{B-C}$  = \_\_\_\_\_

Apparent Specific Gravity =  $\frac{A}{A-C}$  = \_\_\_\_\_

Absorption, percent =  $\frac{B-A}{A} \times 100$  = \_\_\_\_\_

Report Specific Gravities to the nearest 0.01  
Report Absorption to the nearest 0.1%

T306  
Rev.12-01

WEST VIRGINIA DIVISION OF HIGHWAYS  
MATERIALS CONTROL SOILS & TESTING DIVISION

BULK SPECIFIC GRAVITY AND ABSORPTION  
COARSE AGGREGATE

Laboratory No. \_\_\_\_\_

Field Sample No. \_\_\_\_\_

Date \_\_\_\_\_

Source \_\_\_\_\_

Tested By \_\_\_\_\_

(Record masses to 1 g)

A = Mass of oven-dry sample in air, grams \_\_\_\_\_

B = Mass of saturated-surface-dry sample in air, grams \_\_\_\_\_

C = Mass of saturated sample in water, grams \_\_\_\_\_

Bulk Specific Gravity (Oven Dry Basis) =  $\frac{A}{B-C}$  = \_\_\_\_\_

Bulk Specific Gravity (Saturated-Surface-Dry Basis) =  $\frac{B}{B-C}$  = \_\_\_\_\_

Apparent Specific Gravity =  $\frac{A}{A-C}$  = \_\_\_\_\_

Absorption, percent =  $\frac{B-A}{A} \times 100$  = \_\_\_\_\_

Report Specific Gravities to the nearest 0.01  
Report Absorption to the nearest 0.1%

Answers to the exercise problems are as follows:

Fine Aggregate Sample No.	Bulk Specific Gravity Oven Dry	Bulk Specific Gravity SSD	Apparent Specific Gravity	Absorption, %
1	2.60	2.61	2.63	0.4
2	2.72	2.78	2.88	2.0
3	2.32	2.34	2.36	0.8
4	2.69	2.72	2.76	0.8
5	2.61	2.68	2.81	2.8

Coarse Aggregate Sample No.	Bulk Specific Gravity Oven Dry	Bulk Specific Gravity SSD	Apparent Specific Gravity	Absorption, %
1	2.33	2.43	2.58	4.1
2	2.30	2.42	2.61	5.1
3	2.29	2.43	2.67	6.1
4	2.07	2.16	2.27	4.2
5	2.10	2.16	2.22	2.6

**(This completes Chapter 4. Find the answers to the 10 questions on Page 4-36 and mark or highlight the answers for easy retrieval during the written part of the Aggregate Technician Exam.)**

## **CHAPTER FOUR STUDY QUESTIONS**

1. What is specific gravity?
2. What role does temperature play in specific gravity tests?
3. What is Saturated-Surface-Dry (SSD) condition?
4. What is absorption?
5. What is the minimum weight of a specific gravity sample for fine aggregate?
6. Why do we use distilled water to calibrate our pycnometer?
7. What must we do to our fine aggregate sample if we dry it past SSD?
8. How would you adjust the temperature of a fine aggregate sample in the pycnometer if you are outside the temperature range of  $73.4 \pm 3^{\circ}\text{F}$  ( $23 \pm 1.7^{\circ}\text{C}$ )?
9. Why does the large container of water in the Specific Gravity test for coarse aggregate have an overflow pipe?
10. What size is the wire basket used in the coarse Specific Gravity test?







## CHAPTER 5

### UNIT WEIGHT (BULK DENSITY)

Unit weight is a physical measurement of an aggregate and represents the weight of a specific volume. Simply defined, *it is the weight per unit volume of an aggregate and is normally expressed as pounds per cubic foot (lb/ft<sup>3</sup>), or kilograms per cubic meter (kg/m<sup>3</sup>).* In this chapter we are using standard units, however, metric units may be substituted where standard units are stated and have been included in some of the charts and tables throughout this chapter. This designation is used on the entire fine, coarse and/or mixed aggregate, applicable to the test method AASHTO T 19.

The reason for this test method is to find out what a certain volume of an aggregate type weighs. To maintain uniformity between tests we must have a standard unit for recording all weights. Suppose we put a bag of aggregate on a scale and it weighs 60 lbs. We could say that the unit weight is 60 lbs. per bag. How close would we really be to an accurate unit weight and what would this unit weight mean? The next bag full of aggregate from the same stockpile might weigh 65 lb. or 55 lb., depending on how much aggregate is in the bag. Because of this uncertainty we need to have a standard unit of measurement; the cubic foot (ft<sup>3</sup>). We also need a standard procedure for putting the aggregate into the cubic foot unit. This procedure is found in T 19.

Our unit weight test begins with understanding the cubic foot (ft<sup>3</sup>). Our test method allows us to use measures (containers) designated to hold portions of a cubic foot: 1 ft<sup>3</sup>, 1/2 ft<sup>3</sup>, 1/3 ft<sup>3</sup>, and 1/10 ft<sup>3</sup>. A cube having the dimensions 1 ft. x 1 ft. x 1 ft., or a volume of 1 ft<sup>3</sup>, is illustrated on the following page with its corresponding measure. Other incrementally smaller cubes and corresponding measures are also illustrated. Selection of the measure is based on the nominal maximum size of the aggregate being tested. The larger the nominal maximum size of the aggregate, the larger the measure required for the test. In summary thus far, what do we know? We know we have a test method,

\*\*\*Not to Scale\*\*\*

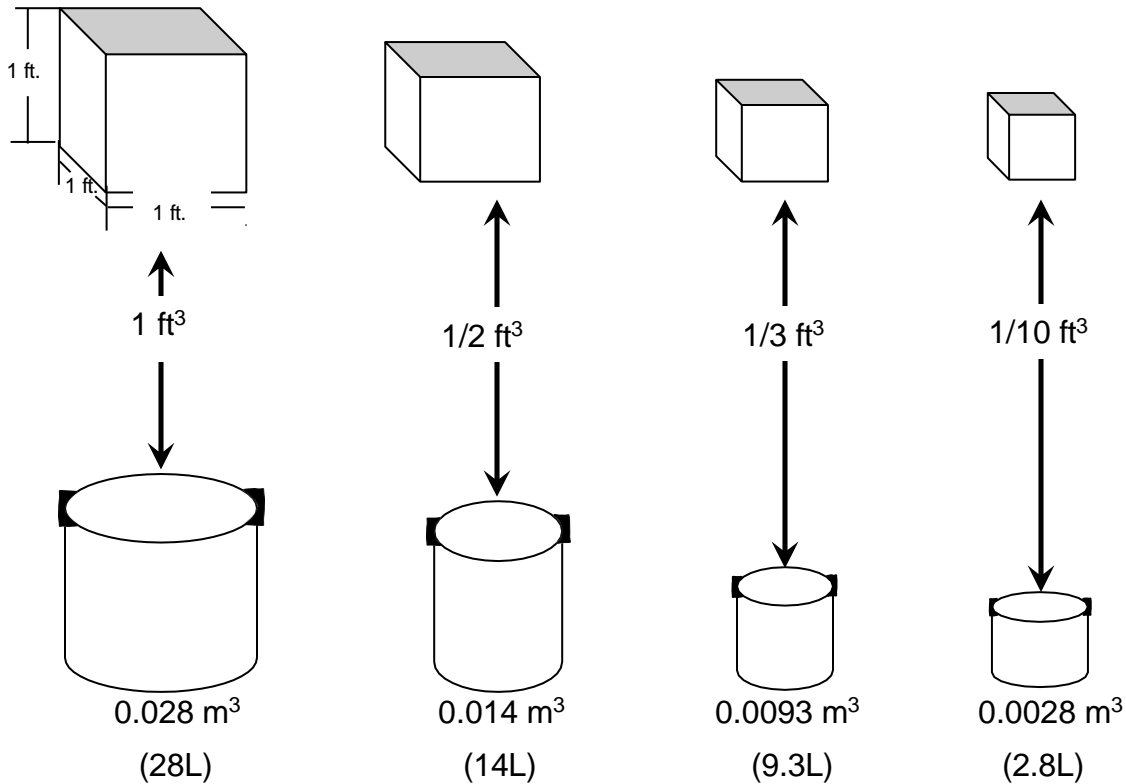

AASHTO T 19, for determining the unit weight of an aggregate. We know unit weight of an aggregate is a measure in lb/ ft<sup>3</sup>. We know if we want to determine how much 1 ft<sup>3</sup> of aggregate weighs, we have four different measures to choose from, depending on the nominal maximum size of the aggregate sample.

As an example, assume that we have filled a 1/3 ft.<sup>3</sup> measure with aggregate and we have determined that the aggregate weighs 30 lbs. We can see that it would take the contents of approximately 3 of these measures to fill an entire 1 ft<sup>3</sup> measure. Approximately how much would 1 ft.<sup>3</sup> of the aggregate weigh?

$$1/3 \text{ ft.}^3 \times 3 = 1 \text{ ft.}^3$$

$$30 \text{ lb.} \times 3 = 90 \text{ lb/ ft.}^3$$

**Measure Correction Factor:**

Our test method tells us there is a more accurate way to arrive at the lb/ft<sup>3</sup> unit weight of the aggregate. In case the measure has any deficiencies that would alter or otherwise affect its reliability for an accurate measurement, we have to develop a multiplication factor. This factor would be used instead of 3 to multiply the 30 lb. in our last problem (page 2). The procedure for developing the factor is referred to as calibrating the measure. We will need a glass plate at least 1/4 in. (6 mm) thick, and a supply of non-water-soluble grease. Apply a thin film of grease to the rim of the measure and weigh the measure with grease and the glass plate. After determining this initial weight, the measure is filled with water at room temperature. The glass plate is placed over the measure with just a small corner open, and the measure is filled to capacity with a syringe avoiding any spillage. This is done in such a manner as to eliminate all air bubbles. The final weight of the measure, grease, glass, and water is then determined, and the initial weight is subtracted. This will give you the weight of water in the measure in pounds, grams or kilograms depending upon the scale being used. When filling the measure, the water temperature must be determined. There is a table in the test method indicating what 1 ft<sup>3</sup> of water should weigh at certain temperatures (See the expanded version of this table on page 5-4). We use this table when calculating the factor.

Let us work now on an example and calculate the factor. Suppose we have determined the 1/3ft<sup>3</sup> (nominal volume) measure to contain 21 lbs. of water at a temperature of 73.4°F (23.0°C). The table in the test method tells us that at 73.4°F (23.0°C), 1ft<sup>3</sup> of water weighs 62.274 lbs. (997.64 kg/m<sup>3</sup>). Our factor is now obtained by dividing the weight of 1ft<sup>3</sup> of water at 73.4 °F (23.0 °C) by what the water required to fill the measure (which we determined to be 21 lbs.) weighs.

$$\text{Thus ..... } \frac{62.274 \text{ lb/ft}^3}{21 \text{ lb. in our } 1/3 \text{ ft.}^3 \text{ measure}} = 2.965$$

Thus 2.965 is our factor and the number which we would use to multiply, instead of 3 to give us a more accurate weight measurement per cubic foot.

**WATER DENSITY AT VARIOUS TEMPERATURES - FARENHEIT**

°F	lb/ft <sup>3</sup>	°F	lb/ft <sup>3</sup>	°F	lb/ft <sup>3</sup>	°F	lb/ft <sup>3</sup>	°F	lb/ft <sup>3</sup>
60.0	<b>62.366</b>	65.4	<b>62.333</b>	70.8	<b>62.295</b>	76.2	<b>62.250</b>	81.6	<b>62.200</b>
60.2	<b>62.365</b>	65.6	<b>62.332</b>	71.0	<b>62.293</b>	76.4	<b>62.249</b>	81.8	<b>62.199</b>
60.4	<b>62.364</b>	65.8	<b>62.331</b>	71.2	<b>62.292</b>	76.6	<b>62.247</b>	82.0	<b>62.196</b>
60.6	<b>62.363</b>	66.0	<b>62.329</b>	71.4	<b>62.290</b>	76.8	<b>62.245</b>	82.2	<b>62.195</b>
60.8	<b>62.362</b>	66.2	<b>62.328</b>	71.6	<b>62.289</b>	77.0	<b>62.244</b>	82.4	<b>62.193</b>
61.0	<b>62.360</b>	66.4	<b>62.327</b>	71.8	<b>62.287</b>	77.2	<b>62.242</b>	82.6	<b>62.191</b>
61.2	<b>62.359</b>	66.6	<b>62.325</b>	72.0	<b>62.286</b>	77.4	<b>62.240</b>	82.8	<b>62.189</b>
61.4	<b>62.358</b>	66.8	<b>62.324</b>	72.2	<b>62.284</b>	77.6	<b>62.238</b>	83.0	<b>62.187</b>
61.6	<b>62.357</b>	67.0	<b>62.322</b>	72.4	<b>62.282</b>	77.8	<b>62.236</b>	83.2	<b>62.184</b>
61.8	<b>62.356</b>	67.2	<b>62.321</b>	72.6	<b>62.281</b>	78.0	<b>62.234</b>	83.4	<b>62.182</b>
62.0	<b>62.355</b>	67.4	<b>62.320</b>	72.8	<b>62.279</b>	78.2	<b>62.233</b>	83.6	<b>62.180</b>
62.2	<b>62.353</b>	67.6	<b>62.318</b>	73.0	<b>62.278</b>	78.4	<b>62.231</b>	83.8	<b>62.178</b>
62.4	<b>62.352</b>	67.8	<b>62.317</b>	73.2	<b>62.276</b>	78.6	<b>62.229</b>	84.0	<b>62.176</b>
62.6	<b>62.351</b>	68.0	<b>62.316</b>	73.4	<b>62.274</b>	78.8	<b>62.227</b>	84.2	<b>62.174</b>
62.8	<b>62.350</b>	68.2	<b>62.314</b>	73.6	<b>62.273</b>	79.0	<b>62.225</b>	84.4	<b>62.172</b>
63.0	<b>62.349</b>	68.4	<b>62.313</b>	73.8	<b>62.271</b>	79.2	<b>62.223</b>	84.6	<b>62.170</b>
63.2	<b>62.347</b>	68.6	<b>62.311</b>	74.0	<b>62.269</b>	79.4	<b>62.222</b>	84.8	<b>62.168</b>
63.4	<b>62.346</b>	68.8	<b>62.310</b>	74.2	<b>62.268</b>	79.6	<b>62.220</b>	85.0	<b>62.166</b>
63.6	<b>62.345</b>	69.0	<b>62.308</b>	74.4	<b>62.266</b>	79.8	<b>62.218</b>	85.2	<b>62.164</b>
63.8	<b>62.344</b>	69.2	<b>62.307</b>	74.6	<b>62.264</b>	80.0	<b>62.216</b>	85.4	<b>62.162</b>
64.0	<b>62.343</b>	69.4	<b>62.305</b>	74.8	<b>62.263</b>	80.2	<b>62.214</b>	85.6	<b>62.160</b>
64.2	<b>62.341</b>	69.6	<b>62.304</b>	75.0	<b>62.261</b>	80.4	<b>62.212</b>	85.8	<b>62.158</b>
64.4	<b>62.340</b>	69.8	<b>62.302</b>	75.2	<b>62.259</b>	80.6	<b>62.210</b>	86.0	<b>62.155</b>
64.6	<b>62.338</b>	70.0	<b>62.301</b>	75.4	<b>62.258</b>	80.8	<b>62.208</b>	86.2	<b>62.153</b>
64.8	<b>62.337</b>	70.2	<b>62.299</b>	75.6	<b>62.256</b>	81.0	<b>62.206</b>	86.4	<b>62.151</b>
65.0	<b>62.336</b>	70.4	<b>62.298</b>	75.8	<b>62.254</b>	81.2	<b>62.204</b>	86.6	<b>62.149</b>
65.2	<b>62.335</b>	70.6	<b>62.296</b>	76.0	<b>62.252</b>	81.4	<b>62.202</b>	86.8	<b>62.147</b>

WATER DENSITY AT VARIOUS TEMPERATURES - CELCIUS

<b>°C</b>	<b>kg/m<sup>3</sup></b>	<b>°C</b>	<b>kg/m<sup>3</sup></b>	<b>°C</b>	<b>kg/m<sup>3</sup></b>
15.0	999.11	20.4	998.12	25.8	996.84
15.2	999.08	20.6	998.07	26.0	996.79
15.4	999.05	20.8	998.03	26.2	996.73
15.6	999.01	21.0	997.99	26.4	996.68
15.8	998.98	21.2	997.95	26.6	996.62
16.0	998.95	21.4	997.90	26.8	996.57
16.2	998.91	21.6	997.86	27.0	996.51
16.4	998.88	21.8	997.81	27.2	996.46
16.6	998.85	22.0	997.77	27.4	996.40
16.8	998.81	22.2	997.72	27.6	996.35
17.0	998.78	22.4	997.68	27.8	996.29
17.2	998.74	22.6	997.63	28.0	996.23
17.4	998.70	22.8	997.58	28.2	996.18
17.6	998.67	23.0	997.54	28.4	996.12
17.8	998.63	23.2	997.49	28.6	996.06
18.0	998.59	23.4	997.44	28.8	996.00
18.2	998.56	23.6	997.39	29.0	995.95
18.4	998.52	23.8	997.35	29.2	995.89
18.6	998.48	24.0	997.30	29.4	995.83
18.8	998.44	24.2	997.25	29.6	995.77
19.0	998.40	24.4	997.20	29.8	995.71
19.2	998.36	24.6	997.15	30.0	995.65
19.4	998.32	24.8	997.10		
19.6	998.28	25.0	997.05		
19.8	998.24	25.2	996.99		
20.0	998.20	25.4	996.94		
20.2	998.16	25.6	996.89		

The measure factor is to be **rounded to three decimal places** (0.001). The example above tells us the volume of our  $1/3 \text{ ft}^3$  measure is slightly more than  $1/3 \text{ ft}^3$ . If it were exactly  $1/3 \text{ ft}^3$ , we would simply multiply by a factor of 3. The measures currently used for unit weight were originally designed to be even increments of one cubic foot (i.e.,  $1/10 \text{ ft}^3$  measure which is the  $0.0028 \text{ m}^3$  measure in metric size) to maintain consistent with the standard units of measurement.

One important thing to note is that most scales weigh in grams (g) and that the density of water at various temperatures in the applicable tables is given in  $\text{lb}/\text{ft}^3$ . Because of this, the weight of the water in the measure must be converted to pounds before completing the calculation for the measure correction factor. Since there are 453.6 grams per pound, to convert grams to pounds, divide the number of grams by 453.6 and the result will be in pounds. When calculating a metric factor, it is necessary to convert grams to kilograms since the metric density for water is given in  $\text{kg}/\text{m}^3$ . This is accomplished by dividing the number of grams by 1000. All weights measured in the unit weight test should be determined to the nearest **50 g (0.05 kg) or 0.1 lb.**

The form used for determining the correction factor for the unit weight measure is the T303. A copy of this form can be seen on page 5-13.

The multiplication factor will be calculated the same way regardless of which measure is applicable to the test.

### **Unit Weight Test:**

At this point let us review. An aggregate sample arrives in the laboratory for the unit weight test and we should record the pertinent information on the form used in the unit weight test, the T304. A copy of this form can be found on page 5-14. The first thing we do is dry the field sample to a constant weight at  $230 \pm 9^\circ\text{F}$ . The importance of drying the sample is obvious. We do not want any weight change throughout the test. After the sample has been dried to constant weight, we must reduce the field sample to a proper

test portion size (depending on the type and condition of the aggregate, it may be easier to split out the test portion and then oven dry it). **According to T 19 the sample size should be 125% - 200% of the amount of material required to fill the measure used.** Therefore, in order to know how much material to split out we need to select the appropriate measure. This selection is based on the nominal maximum size of the aggregate to be tested and is as follows:

Nominal Maximum Size		Measure Size	
in.	mm	ft. <sup>3</sup>	m <sup>3</sup>
5	125.0	3 1/2	0.100
4 1/2	112.0	2 1/2	0.070
3	75.0	1	0.028
1 1/2	37.5	1/2	0.014
1	25.0	1/3	0.0093
1/2	12.5	1/10	0.0028

**Note:** The 1 ft.<sup>3</sup> measure is the largest measure used in the unit weight test.

This table is included in T 19. From the table, we can use the 1 ft.<sup>3</sup> (0.028 m<sup>3</sup>) measure for any size aggregate up to 3 in. (75 mm) nominal maximum size. We can, however, only use the 1/3 ft.<sup>3</sup> (0.0093 m<sup>3</sup>) measure for aggregate with 1 in. (25 mm) nominal maximum size or smaller. Suppose we have an aggregate with 1 in. (25 mm) nominal maximum size, and decide to use the 1/2 ft.<sup>3</sup> (0.014 m<sup>3</sup>) measure. From the table we see we can use the 1/2 ft.<sup>3</sup> (0.014 m<sup>3</sup>) measure for any size aggregate if it does not exceed 1 1/2 in. nominal maximum size.

There are several reasons why we might select a smaller measure for tests instead of the 1 ft.<sup>3</sup> (0.028 m<sup>3</sup>) measure. Maybe we do not have enough sample to fill a 1 ft.<sup>3</sup> (0.028 m<sup>3</sup>) measure or maybe we realize the weight of the 1 ft.<sup>3</sup> (0.028 m<sup>3</sup>) measure would be difficult to handle when full. In any case we can get an accurate unit weight by using one of the smaller measures when applicable. The dried sample can now be split down to a test

portion 125% to 200% of the amount required to fill the selected measure.

The next step is to select the method for testing. Our test method gives us three procedures for testing depending on the nominal maximum size of the aggregate. The three procedures, with their corresponding nominal maximum size of aggregate, are as follows:

1. *Rodding Procedure*..... 1 1/2 in. (37.5 mm) or less
2. *Jigging Procedure*..... Greater than 1 1/2 in. (37.5 mm)  
but not exceeding 5 in. (125 mm)
3. *Shoveling Procedure*..... 5 in. (125 mm) or less - ( Only for  
loose unit weight determination.)

Let us look at each of the above procedures now to complete our test.

**THE RODDING PROCEDURE** is designed for all material with a nominal maximum size of 1 1/2 in. (37.5 mm) or less. First determine the factor for the selected measure (page 5-5). Next, determine the weight of the empty measure to the nearest 0.05 kg or 50 g. Mix the sample thoroughly before filling the measure to eliminate any possible segregation during handling. Fill the measure to one-third full with a scoop and level with the fingers. With a tamping rod (specifications for the rod are in the test method), strike or rod the layer of aggregate 25 times, distributing the strokes evenly over the surface. Be careful that the tip of the rod does not hit the bottom of the measure forcibly. Now fill the measure two-thirds full, level and rod 25 times as above. Rod the second layer down to, but not penetrating, the first layer. Finally, fill the measure to overflowing (do not level with the fingers) and again rod 25 times in the same manner as for the second layer. When all rodding is complete, level the surface of the aggregate with your fingers or a straight edge so that any slight projections of the larger pieces of aggregate above the rim of the measure approximately balance any voids below the rim of the measure. Determine the net weight of the aggregate to the nearest 0.05 kg (50 g) by subtracting the weight of the empty measure. Convert the net weight to pounds or kilograms if



necessary, and multiply the net weight of the aggregate by the measure's correction factor, and the answer will be the unit weight in lb/ft<sup>3</sup> (kg/m<sup>3</sup>). Unit weight results shall be reported to the nearest lb/ft<sup>3</sup> or 10 kg/m<sup>3</sup>.

**THE JIGGING PROCEDURE** is designed for aggregate with a nominal maximum size greater than 1 1/2 in. (37.5 mm) but not exceeding 5 in. (125 mm). First fill the measure one-third full and level surface as in the rodding procedure. In this method, however, we do not use the tamping rod to compact the aggregate. We compact the aggregate by placing the measure on a firm base such as a concrete floor, then raising one side of the measure approximately 2 in. (50 mm) off the floor and allowing the measure to drop. This we do alternately on opposite sides of the measure, 25 times for each side, or a total of 50 times. Now, fill the measure two thirds full, level surface and drop 50 times. Fill the measure to overflowing, complete the same compacting procedure of 50 drops, and then level the surface as we did in the rodding procedure. Determine the net weight of the aggregate in pounds or kilograms and multiply by the measure correction factor for the unit weight.

**THE SHOVELING PROCEDURE** is different from the other two procedures. If we are interested in a loose unit weight determination, we would use this method. All we need to do is fill the measure to overflowing with a scoop or shovel discharging the aggregate from a height not to exceed 2 in. (50 mm) above the rim of the measure. Then level the surface with our fingers or the straight edge, as in the rodding procedure, and determine the net weight of the aggregate. The calculations are completed in the same manner as our other tests, by multiplying the weight of aggregate in pounds or kilograms by the correction factor for the measure. In the shoveling procedure, you recall, we use any size aggregate up to 5 in. (125 mm) nominal maximum size.

At this point it is important to note again that most scales weigh in grams (g). The weight of the aggregate in the measure must be converted to pounds or kilograms, as previously described, to carry out the calculation for the unit weight. This is due to the fact that the

measure correction factor was determined with the density of water expressed in lb./ ft.<sup>3</sup> or kg/m<sup>3</sup>. Remember when weighing material for the unit weight test, all weights are to be recorded to the nearest 0.1 lb (0.05 kg or 50 g).

Suppose we are calculating our factor and have determined the following:

Weight of measure, glass, grease, and water	=	23,800 g
Weight of measure, glass, and grease	=	<u>-9,350 g</u>
Weight of water	=	14,450 g

Here we have weight of water in grams and need it to be in pounds to complete our factor calculations. We will round our answer to the nearest 0.1 lb.

$$\text{Thus... } \frac{14,450 \text{ g}}{453.6 \text{ g/lb}} = 31.9 \text{ lb.}$$

Remember, we divide our weight of water into the weight of 1 ft.<sup>3</sup> of water at that temperature. If we have a water temperature of 70 °F (21.1 °C), the test method tells us 1 ft.<sup>3</sup> of water at this temperature should weigh 62.301 lb/ ft<sup>3</sup>. In this case we are using the 1/2 ft.<sup>3</sup> ( 0.014 m<sup>3</sup>) measure, so we had 31.9 lb. in our 1/2 ft.<sup>3</sup> (0.014 m<sup>3</sup>) measure.

By dividing .....

$$\frac{62.301 \text{ lb/ft}^3}{31.9 \text{ lb. in our } 1/2 \text{ ft.}^3 \text{ measure}} = 1.953$$

..... we get 1.953 as our 1/2 ft.<sup>3</sup> (0.014 m<sup>3</sup>) measure correction factor.

The same conversion method is also used when we calculate the net weight of the aggregate. Suppose we had continued our test and had determined the following:

Weight of measure & aggregate	=	25,050 g
Weight of measure	=	<u>8,300 g</u>
Weight of aggregate	=	16,750 g or 16.75 kg
Convert to pounds	=	16,750 g ÷ 453.6 g/lb = 36.9 lb.

So, our weight of aggregate in the measure is 36.9 lb. We finish the calculation by multiplying with our factor:

$$36.9 \text{ lb. in our } 1/2 \text{ ft.}^3 \text{ (0.014 m}^3\text{) measure } \times 1.953 = 72 \text{ lb/ft.}^3$$

Let us do a problem now by calculating and converting the following total gram weight into lb.

Weight of measure and aggregate	= 24,000 g
Weight of measure	= <u>6,000 g</u>
Weight of aggregate	= _____

What is the correct answer?

In review, all we need to determine the unit weight of an aggregate is to calculate the factor for the measure, calculate the net weight of the aggregate and multiply the two. There are, however, certain definite procedures to follow to accomplish this. These procedures have been outlined here and are stated in AASHTO T 19 test for unit weight.

One last thing to note is that in West Virginia we conduct at least two trials of this test and average the results as indicated on the T304 worksheet. **Trials are continued until two consecutive trials fall within 2.5 lb/ft.<sup>3</sup> (40 kg/m<sup>3</sup>) by the same technician.** This is done to get a better estimate of the true unit weight of the material and to act as a check for test precision. If results repeatedly differ by greater than the tolerance on the first two trials, an investigation of the procedure and equipment should be conducted.

Complete the example exercises for unit weights on an AASHTO #57 limestone below with the worksheets on pages 5-15 to 5-22. The answers can be found in the table on page 5-23.

	Exercise 1	Exercise 2	Exercise 3	Exercise 4
Weight of measure, water, glass, and grease	15100 g Temp 76° F	20700 g Temp 74°F	19050 g Temp 77°F	22650 g Temp 75°F
Weight of measure, glass, and grease	5650 g	6700 g	9750 g	9450 g
Weight of measure and aggregate	Trial 1-22400 g Trial 2-22550 g	Trail 1-26950 g Trail 2-26850 g	Trial 1-21200 g Trial 2-21250 g	Trial 1-23800 g Trial 2-23950 g
Weight of measure	5050 g	5600 g	5550 g	5850 g

T303E

WEST VIRGINIA DIVISION OF HIGHWAYS

Rev. 5-03

MATERIALS CONTROL SOILS AND TESTING DIVISION  
UNIT WEIGHT OF AGGREGATE AASHTO T 19 (ASTM C-29)  
CALIBRATION OF UNIT WEIGHT MEASURE

DATE \_\_\_\_\_

CALIBRATED BY \_\_\_\_\_

MEASURE SIZE \_\_\_\_\_

A. Weight of Measure, Glass, Grease, and Water \_\_\_\_\_

B. Weight of Measure, Glass, and Grease \_\_\_\_\_

C. Weight of Water in Measure \_\_\_\_\_

D. Convert g to lb. if necessary \_\_\_\_\_

E. Temperature of Water (Nearest 0.2°F or 0.1°C) \_\_\_\_\_

F. Weight of Water at Temperature E (from Tables in Aggregate Manual  
Chap. 5, AASHTO T19, or ASTM C29) \_\_\_\_\_

G. Factor for Measure (Round to nearest thousandth) \_\_\_\_\_

All weights rounded to the nearest 0.1 lb. or 50 g (0.05 kg)

$$C = A - B$$

$$D = C \div 453.6 \text{ (If C measured in g)}$$

$$= C \text{ (If C measured in lb)}$$

$$G = F \div D$$

WEST VIRGINIA DIVISION OF HIGHWAYS  
MATERIALS CONTROL, SOILS AND TESTING DIVISION  
UNIT WEIGHT OF AGGREGATE

Lab Number		Project and Contract					Date Sampled			Transmit Date
		C								
Test Sequence	Material Code	Quantity					Item Number	Plant Source Code		Aggregate Source Code
Sieves:	1st	2nd	3rd	4th	5th	6th	7th	8th	No. 200	
Design Number	Bitumen Content		Unit Weight		Face Fracture		LL	PL	PI	
		Target	Actual		%One	%Two				
AASHTO Size	Smallest Sieve	100%	Target A-bar	Actual A-bar	FA A-bar	CA No. 200	FA No. 200	Total No. 200	P/F/N	

Technician \_\_\_\_\_ Rodded \_\_\_\_\_ Loose \_\_\_\_\_ Jigged \_\_\_\_\_

Source \_\_\_\_\_ Date \_\_\_\_\_ Field Sample # \_\_\_\_\_

	1st Trial	2nd Trial
A. Weight of Measure and Aggregate	_____	_____
B. Weight of Measure	_____	_____
C. Weight of Aggregate	_____	_____
D. Convert Wt. of Aggregate from g to lb. if necessary	_____	_____
E. Correction Factor of Measure (Report to the nearest 0.001)	_____	_____
F. Weight per Cubic Foot (Report to the nearest lb./ft. <sup>3</sup> )	_____	_____
G. Average Wt. per Cubic Foot (Report to the nearest lb./ft. <sup>3</sup> )	_____	
H. Average Tons/yd. <sup>3</sup> (Report to the nearest 0.01 ton/yd. <sup>3</sup> )	_____	

All weights measured to the nearest 0.1 lb. or 50 g (0.05 kg)

$C = A - B$

$D = C \div 453.6 \text{ g}$  (if C is measured in g)

$F = D \times E$

$G = (F_{1st} + F_{2nd}) \div 2$

$H = G \times 27 \div 2000$

T303E

WEST VIRGINIA DIVISION OF HIGHWAYS

Rev. 5-03

MATERIALS CONTROL SOILS AND TESTING DIVISION  
UNIT WEIGHT OF AGGREGATE AASHTO T 19 (ASTM C-29)  
CALIBRATION OF UNIT WEIGHT MEASURE

DATE \_\_\_\_\_

CALIBRATED BY \_\_\_\_\_

MEASURE SIZE \_\_\_\_\_

A. Weight of Measure, Glass, Grease, and Water \_\_\_\_\_

B. Weight of Measure, Glass, and Grease \_\_\_\_\_

C. Weight of Water in Measure \_\_\_\_\_

D. Convert g to lb. if necessary \_\_\_\_\_

E. Temperature of Water (Nearest 0.2°F or 0.1°C) \_\_\_\_\_

F. Weight of Water at Temperature E (from Tables in Aggregate Manual  
Chap. 5, AASHTO T19, or ASTM C29) \_\_\_\_\_

G. Factor for Measure (Round to nearest thousandth) \_\_\_\_\_

All weights rounded to the nearest 0.1 lb. or 50 g (0.05 kg)

$C = A - B$

$D = C \div 453.6$  (If C measured in g)  $D$

$= C$  (If C measured in lb)

$G = F \div D$

WEST VIRGINIA DIVISION OF HIGHWAYS  
MATERIALS CONTROL, SOILS AND TESTING DIVISION  
UNIT WEIGHT OF AGGREGATE

Lab Number		Project and Contract					Date Sampled			Transmit Date
Test Sequence	Material Code	C					Item Number	Plant Source Code	Aggregate Source Code	
		Quantity		Unit Weight		Face Fracture %One %Two				
Sieves:	1st	2nd	3rd	4th	5th	6th	7th	8th	No. 200	
Design Number	Bitumen Content Target Actual		Unit Weight		Face Fracture %One %Two		LL	PL	PI	
AASHTO Size	Smallest Sieve 100%	Target A-bar	Actual A-bar	FA A-bar	CA No. 200	FA No. 200	Total No. 200	P/F/N		

Technician \_\_\_\_\_ Rodded \_\_\_\_\_ Loose \_\_\_\_\_ Jigged \_\_\_\_\_

Source \_\_\_\_\_ Date \_\_\_\_\_ Field Sample # \_\_\_\_\_

	1st Trial	2nd Trial
A. Weight of Measure and Aggregate	_____	_____
B. Weight of Measure	_____	_____
C. Weight of Aggregate	_____	_____
D. Convert Wt. of Aggregate from g to lb. if necessary	_____	_____
E. Correction Factor of Measure (Report to the nearest 0.001)	_____	_____
F. Weight per Cubic Foot (Report to the nearest lb./ft. <sup>3</sup> )	_____	_____
G. Average Wt. per Cubic Foot (Report to the nearest lb./ft. <sup>3</sup> )	_____	
H. Average Tons/yd. <sup>3</sup> (Report to the nearest 0.01 ton/yd. <sup>3</sup> )	_____	

- All weights measured to the nearest 0.1 lb. or 50 g (0.05 kg)
- C = A - B
- D = C ÷ 453.6 g (if C is measured in g)
- F = D x E
- G = (F<sub>1st</sub> + F<sub>2nd</sub>) ÷ 2
- H = G x 27 ÷ 2000



T303E

WEST VIRGINIA DIVISION OF HIGHWAYS

Rev. 5-03

MATERIALS CONTROL SOILS AND TESTING DIVISION  
UNIT WEIGHT OF AGGREGATE AASHTO T 19 (ASTM C-29)  
CALIBRATION OF UNIT WEIGHT MEASURE

DATE \_\_\_\_\_

CALIBRATED BY \_\_\_\_\_

MEASURE SIZE \_\_\_\_\_

A. Weight of Measure, Glass, Grease, and Water \_\_\_\_\_

B. Weight of Measure, Glass, and Grease \_\_\_\_\_

C. Weight of Water in Measure \_\_\_\_\_

D. Convert g to lb. if necessary \_\_\_\_\_

E. Temperature of Water (Nearest 0.2°F or 0.1°C) \_\_\_\_\_

F. Weight of Water at Temperature E (from Tables in Aggregate Manual  
Chap. 5, AASHTO T19, or ASTM C29) \_\_\_\_\_

G. Factor for Measure (Round to nearest thousandth) \_\_\_\_\_

All weights rounded to the nearest 0.1 lb. or 50 g (0.05 kg)

$$C = A - B$$

$$D = C \div 453.6 \text{ (If C measured in g)}$$

$$D = C \text{ (If C measured in lb)}$$

$$G = F \div D$$

T304E  
Rev. 12-01

WEST VIRGINIA DIVISION OF HIGHWAYS  
MATERIALS CONTROL, SOILS AND TESTING DIVISION  
UNIT WEIGHT OF AGGREGATE

Lab Number		Project and Contract					Date Sampled			Transmit Date
		C								
Test Sequence	Material Code	Quantity					Item Number	Plant Source Code		Aggregate Source Code
Sieves:	1st	2nd	3rd	4th	5th	6th	7th	8th	No. 200	
Design Number	Bitumen Content		Unit Weight		Face Fracture		LL	PL	PI	
		Target	Actual		%One	%Two				
AASHTO Size	Smallest Sieve	100%	Target A-bar	Actual A-bar	FA A-bar	CA No. 200	FA No. 200	Total No. 200	P/F/N	

Technician \_\_\_\_\_ Rodded \_\_\_\_\_ Loose \_\_\_\_\_ Jigged \_\_\_\_\_

Source \_\_\_\_\_ Date \_\_\_\_\_ Field Sample # \_\_\_\_\_

	1st Trial	2nd Trial
A. Weight of Measure and Aggregate	_____	_____
B. Weight of Measure	_____	_____
C. Weight of Aggregate	_____	_____
D. Convert Wt. of Aggregate from g to lb. if necessary	_____	_____
E. Correction Factor of Measure (Report to the nearest 0.001)	_____	_____
F. Weight per Cubic Foot (Report to the nearest lb./ft. <sup>3</sup> )	_____	_____
G. Average Wt. per Cubic Foot (Report to the nearest lb./ft. <sup>3</sup> )	_____	_____
H. Average Tons/yd. <sup>3</sup> (Report to the nearest 0.01 ton/yd. <sup>3</sup> )	_____	_____

All weights measured to the nearest 0.1 lb. or 50 g (0.05 kg)

$C = A - B$

$D = C \div 453.6 \text{ g (if C is measured in g)}$

$F = D \times E$

$G = (F_{1st} + F_{2nd}) \div 2$

$H = G \times 27 \div 2000$

T303E

WEST VIRGINIA DIVISION OF HIGHWAYS

Rev. 5-03

MATERIALS CONTROL SOILS AND TESTING DIVISION  
UNIT WEIGHT OF AGGREGATE AASHTO T 19 (ASTM C-29)  
CALIBRATION OF UNIT WEIGHT MEASURE

DATE \_\_\_\_\_

CALIBRATED BY \_\_\_\_\_

MEASURE SIZE \_\_\_\_\_

A. Weight of Measure, Glass, Grease, and Water \_\_\_\_\_

B. Weight of Measure, Glass, and Grease \_\_\_\_\_

C. Weight of Water in Measure \_\_\_\_\_

D. Convert g to lb. if necessary \_\_\_\_\_

E. Temperature of Water (Nearest 0.2°F or 0.1°C) \_\_\_\_\_

F. Weight of Water at Temperature E (from Tables in Aggregate Manual  
Chap. 5, AASHTO T19, or ASTM C29) \_\_\_\_\_

G. Factor for Measure (Round to nearest thousandth) \_\_\_\_\_

All weights rounded to the nearest 0.1 lb. or 50 g (0.05 kg)

$$C = A - B$$

$$D = C \div 453.6 \text{ (If C measured in g)}$$

$$D = C \text{ (If C measured in lb)}$$

$$G = F \div D$$

WEST VIRGINIA DIVISION OF HIGHWAYS  
MATERIALS CONTROL, SOILS AND TESTING DIVISION  
UNIT WEIGHT OF AGGREGATE

Lab Number		Project and Contract					Date Sampled			Transmit Date
Test Sequence	Material Code	C					Item Number	Plant Source Code		Aggregate Source Code
		Quantity								
Sieves:	1st	2nd	3rd	4th	5th	6th	7th	8th	No. 200	
Design Number	Bitumen Content		Unit Weight		Face Fracture		LL	PL	PI	
		Target	Actual		%One	%Two				
AASHTO Size	Smallest Sieve 100%	Target A-bar	Actual A-bar	FA A-bar	CA No. 200	FA No. 200	Total No. 200	P/F/N		

Technician \_\_\_\_\_ Rodded \_\_\_\_\_ Loose \_\_\_\_\_ Jigged \_\_\_\_\_

Source \_\_\_\_\_ Date \_\_\_\_\_ Field Sample # \_\_\_\_\_

	1st Trial	2nd Trial
A. Weight of Measure and Aggregate	_____	_____
B. Weight of Measure	_____	_____
C. Weight of Aggregate	_____	_____
D. Convert Wt. of Aggregate from g to lb. if necessary	_____	_____
E. Correction Factor of Measure (Report to the nearest 0.001)	_____	_____
F. Weight per Cubic Foot (Report to the nearest lb./ft. <sup>3</sup> )	_____	_____
G. Average Wt. per Cubic Foot (Report to the nearest lb./ft. <sup>3</sup> )	_____	
H. Average Tons/yd. <sup>3</sup> (Report to the nearest 0.01 ton/yd. <sup>3</sup> )	_____	

All weights measured to the nearest 0.1 lb. or 50 g (0.05 kg)

$$C = A - B$$

$$D = C \div 453.6 \text{ g (if C is measured in g)}$$

$$F = D \times E$$

$$G = (F_{1st} + F_{2nd}) \div 2$$

$$H = G \times 27 \div 2000$$

T303E

WEST VIRGINIA DIVISION OF HIGHWAYS

Rev. 5-03

MATERIALS CONTROL SOILS AND TESTING DIVISION  
UNIT WEIGHT OF AGGREGATE AASHTO T 19 (ASTM C-29)  
CALIBRATION OF UNIT WEIGHT MEASURE

DATE \_\_\_\_\_

CALIBRATED BY \_\_\_\_\_

MEASURE SIZE \_\_\_\_\_

A. Weight of Measure, Glass, Grease, and Water \_\_\_\_\_

B. Weight of Measure, Glass, and Grease \_\_\_\_\_

C. Weight of Water in Measure \_\_\_\_\_

D. Convert g to lb. if necessary \_\_\_\_\_

E. Temperature of Water (Nearest 0.2°F or 0.1°C) \_\_\_\_\_

F. Weight of Water at Temperature E (from Tables in Aggregate Manual  
Chap. 5, AASHTO T19, or ASTM C29) \_\_\_\_\_

G. Factor for Measure (Round to nearest thousandth) \_\_\_\_\_

All weights rounded to the nearest 0.1 lb. or 50 g (0.05 kg)

$$C = A - B$$

$$D = C \div 453.6 \text{ (If C measured in g)}$$

$$D = C \text{ (If C measured in lb)}$$

$$G = F \div D$$

T304E  
Rev. 12-01

WEST VIRGINIA DIVISION OF HIGHWAYS  
MATERIALS CONTROL, SOILS AND TESTING DIVISION  
UNIT WEIGHT OF AGGREGATE

Lab Number		Project and Contract					Date Sampled			Transmit Date
Test Sequence	Material Code	C					Item Number	Plant Source Code		Aggregate Source Code
		Quantity								
Sieves:	1st	2nd	3rd	4th	5th	6th	7th	8th	No. 200	
Design Number			Bitumen Content Target Actual		Unit Weight	Face Fracture %One %Two		LL	PL	PI
AASHTO Size	Smallest Sieve	100%	Target A-bar		Actual A-bar	FA A-bar	CA No. 200	FA No. 200	Total No. 200	P/F/N

Technician \_\_\_\_\_ Rodded \_\_\_\_\_ Loose \_\_\_\_\_ Jigged \_\_\_\_\_

Source \_\_\_\_\_ Date \_\_\_\_\_ Field Sample # \_\_\_\_\_

	1st Trial	2nd Trial
A. Weight of Measure and Aggregate	_____	_____
B. Weight of Measure	_____	_____
C. Weight of Aggregate	_____	_____
D. Convert Wt. of Aggregate from g to lb. if necessary	_____	_____
E. Correction Factor of Measure (Report to the nearest 0.001)	_____	_____
F. Weight per Cubic Foot (Report to the nearest lb./ft. <sup>3</sup> )	_____	_____
G. Average Wt. per Cubic Foot (Report to the nearest lb./ft. <sup>3</sup> )	_____	
H. Average Tons/yd. <sup>3</sup> (Report to the nearest 0.01 ton/yd. <sup>3</sup> )	_____	

All weights measured to the nearest 0.1 lb. or 50 g (0.05 kg)

$C = A - B$

$D = C \div 453.6 \text{ g}$  (if C is measured in g)

$F = D \times E$

$G = (F_{1st} + F_{2nd}) \div 2$

$H = G \times 27 \div 2000$

## **ANSWERS**

	Exercise 1	Exercise 2	Exercise 3	Exercise 4
Weight of water in measure	9450 g / 20.8 lb.	14000 g / 30.9 lb.	9300 g / 20.5 lb.	13200 g / 29.1 lb.
Density of water at temp.	62.252	62.269	62.244	62.261
Factor for Measure	2.993	2.015	3.036	2.140
Weight of aggregate Trial 1	38.2	47.1	34.5	39.6
Weight of aggregate Trial 2	38.6	46.8	34.6	39.9
Weight per Cubic Foot Trial 1	114	95	105	85
Weight per Cubic Foot Trial 2	116	94	105	85
Average Unit Weight	115	95	105	85
Average Tons/yd <sup>3</sup>	1.55	1.28	1.42	1.15

**(This would conclude the unit weight chapter. Find the answers to the 10 questions on Page 5-24 and mark or highlight the answers for easy retrieval during the written part of the Aggregate Technician Exam.)**

## **CHAPTER 5 STUDY QUESTIONS**

1. What is the Unit Weight of an object?
2. What does the Measure Correction Factor do?
3. How would you convert grams to pounds during your Unit Weight procedure?
4. What factor determines which testing method, rodding, jiggling or shoveling, should be used in the Unit Weight procedure?
5. Multiple trials may be made on the Unit Weight test until the operator comes within this margin of weight between consecutive trials. This amount is \_\_\_\_\_.
6. How much volume of aggregate do you need for your Unit Weight sample to be large enough for the test?
7. In the Rodding Procedure, what do you not want to do as you rod the layers?
8. After the third and final layer of aggregate, what do you do to the surface of the aggregate?
9. How high above the rim of the measure do you add aggregate in the Shoveling Procedure?
10. In the Jiggling Procedure, how far do you lift the side of the measure from the floor before releasing the measure?







**CHAPTER 6**  
**LIQUID LIMIT, PLASTIC LIMIT**  
**AND**  
**THE PLASTICITY INDEX**

**I. LIQUID LIMIT**

Specifications which govern the properties of aggregate used in base course material often set limits upon the liquid limit and plasticity index of the minus No. 40 size material contained therein. It is necessary for us, as aggregate technicians, to know how to perform these tests and understand just what these characteristics mean.

First, liquid and plastic limits are concerned with *soils*. Liquid and plastic limits can be used to assist in classifying soils and discerning some of their engineering properties. Also, a base course aggregate is composed of two principle fractions, namely the coarse aggregate fraction (plus No. 4 material) and the fine aggregate fraction (minus No. 4 material). The fine fraction usually contains a substantial portion of material that passes the No. 40 mesh sieve which is sometimes referred to as "*binder soil*". It is this minus No. 40 material that is of interest when dealing with the liquid limit of a base course aggregate. The binder soil, if it contains an excessive amount of clay material, will not allow water to drain sufficiently from the base course. Liquid limit specifications for stone and crushed aggregate can be found in Table 704.6.28 Quality Requirements (page 1-24). They place a ***maximum liquid limit of 25, or 25% moisture content***, on the classes of aggregate which include base course material.

**LIQUID LIMIT** - The liquid limit is the water content (or moisture content) expressed as a percentage of the weight of the oven dry soil at the boundary between the liquid and plastic states. It is found by dividing the weight of moisture in the soil by the weight of oven dry soil and multiplying by 100. The liquid limit is actually the lowest moisture at which the soil will act in a liquid manner. Thought of in another way, the liquid limit is the moisture content at which the soil has such a small shear strength that it flows when

disturbed in a specified manner. *This moisture content is defined as point at which the two halves of a soil cake in a liquid limit device, separated by the groove, will flow together for a length of ½ in. (13 mm) along the bottom of the groove when the cup is dropped 25 times from a height of 10 mm at the rate of two drops per second.*

The instructions for conducting the test for liquid limit are contained in AASHTO T 89. There are two methods\_ described for conducting the liquid limit:

1. The three-point method using a flow curve to determine the liquid limit.
2. The one-point method requiring the calculation of the liquid limit value using data secured from a single trial.

*The three-point method is the primary method used for this certification. Remember that the **liquid limit** is defined as "the moisture content at which the soil cake would flow together along the bottom of the groove for a distance of ½ inch (13 mm) when the cup of the device is dropped from a height of 10 mm for 25 blows."*

### **THE THREE POINT METHOD**

The form used for calculations in the liquid and plastic limit test is the T307, which replaces the old ST-15. This is a two-sided form. Weights are recorded, and calculations completed on the front of the form. On the back is a sheet of single cycle semi-logarithmic graph paper for plotting the flow curve in the 3-point method. Methods for using this form will be discussed later. A copy of the front of this form can be seen on page 6-9. A copy of single cycle semi-logarithmic graph paper can be seen on page 6-13.

It would be very difficult to conduct enough trials to have precisely the right amount of water in the sample so the groove will close 1/2 inch at exactly twenty-five blows. However, both the three-point method and the one-point method provide means of obtaining groove closures at other than twenty-five blows, while determining what the

moisture content would be at twenty-five blows. This will be demonstrated later. First, we will list the necessary testing equipment.

1. Evaporating dish - About 4 ½ in. (115 mm) in diameter.
2. Spatula - With blade approximately 3 - 4 in. (75 mm -100 mm) in length and ¾ in. (20 mm) in width.
3. Liquid Limit Device - A mechanical device with dimensions as shown in the test procedure.
4. Grooving Tool - A tool with the dimensions as shown by the test procedure.
5. Containers - Suitable for storing and weighing the samples such that moisture will not be lost and made of material resistant to corrosion.
6. Balance - A balance sensitive to 0.01 g.
7. Oven capable of maintaining a temperature of  $230 \pm 9^{\circ}\text{F}$  ( $110 \pm 5^{\circ}\text{C}$ ).
8. A supply of distilled water.
9. A graduated cylinder for measuring the water.
10. A damp cloth or towel for covering the wet sample.

## STEPS FOR THE 3-POINT METHOD

1. Prepare the material in the manner described in AASHTO R58: *Dry Preparation of Disturbed Soils and Soil Aggregate Samples for Test*. Soil may be air dried or oven dried at a maximum temperature of 140°F (60°C). Soil lumps may be broken up with a mortar and a rubber-tipped pestle. The soil is then sieved over a No. 40 sieve.
2. Obtain a test portion of *approximately* 100 g from the material passing the No. 40 mesh sieve.
3. Typically, three containers will be used for weighing and drying the soil. (A fourth container will be needed for the plastic limit specimen). It is best to weigh the containers and record the weights to the nearest 0.01g on form T307 before starting the test.
4. First, check the device for loose or excessively worn parts. Check for side play in the cup, loose screws, worn pin, excessively grooved cup and other items as mentioned in the procedure.
5. Adjust the liquid limit device as shown on page 6-5 in Figure 1. Place a piece of tape across the center of the circle, created where the bottom of the brass cup strikes the base, as shown. Then slide the gage end of the grooving tool (or a calibration block) between the base and the cup as shown. The gage should be against the edge of the tape and flat against the base of the device. Each dimension of the gage end is equal to the 10 mm drop height. Turn the crank of the device which raises and drops the cup. A dull ping should be heard without the cup rising above the tool. If a ping is not heard, or if the cup rises from the gage, adjust the drop height of the cup with the adjustment screws. **Always remove the tape before running the test!**

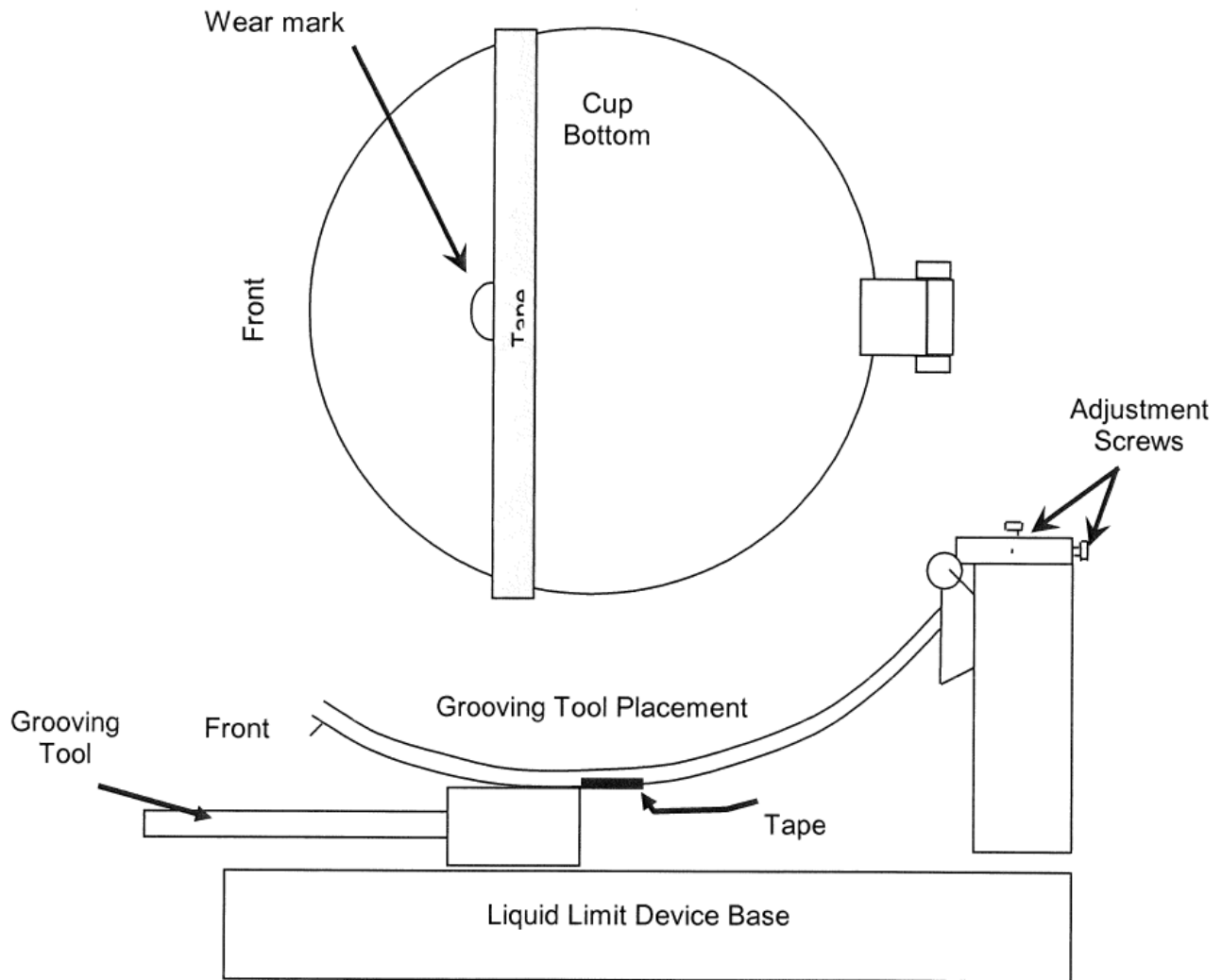

**Figure 1: Liquid Limit Device Adjustment**

6. Place the test portion in the evaporating dish and add from 15 to 20 ml of distilled water and mix thoroughly with the spatula. Do not use the cup of the liquid limit device for mixing the sample.
7. Add small increments of distilled water (1-3 ml) and mix thoroughly until the material appears to be a uniform mixture of a stiff consistency. **No dry soil** may be added after testing begins. If too much distilled water has been added to the sample, it can either be discarded or mixed until the moisture content is lowered through natural evaporation.

A. Soil Cake in Cup

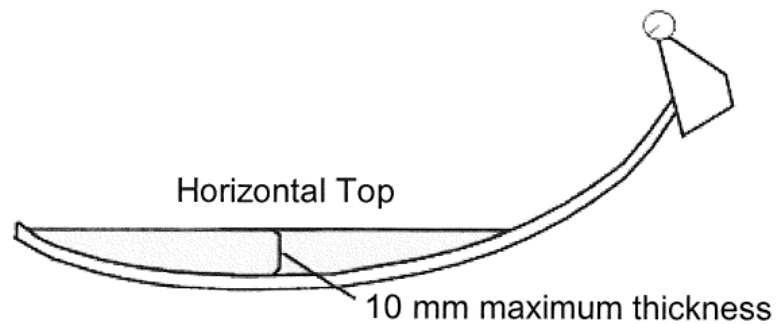

B. Soil Cake After Grooving

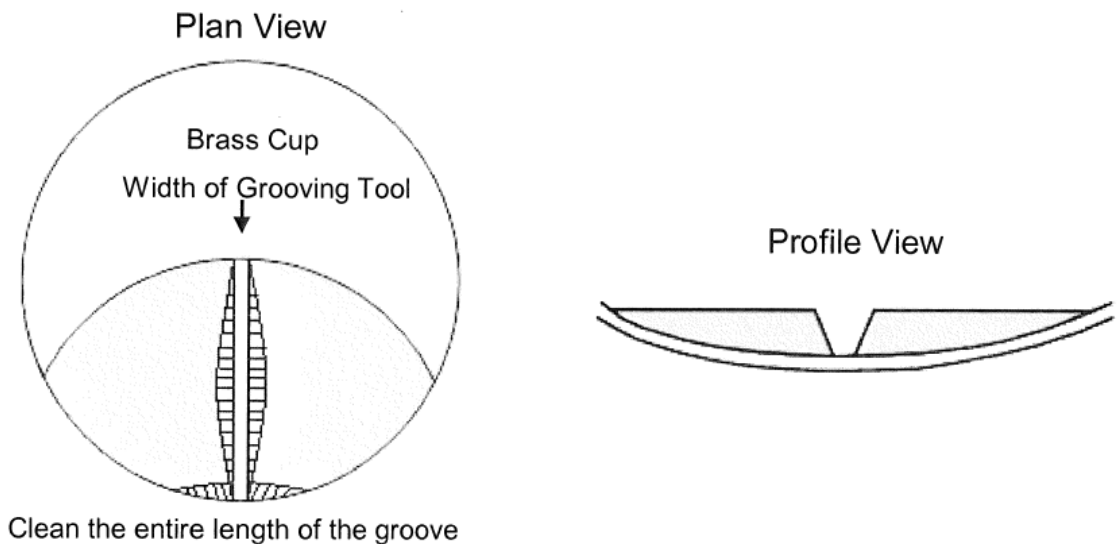

**Figure 2**

- Place a portion of the sample into the cup of the liquid limit device, squeezing and spreading the material with the spatula, forming a level cake 10 mm thick at the maximum depth. Any excess soil should be returned to the mixing dish and covered with a damp towel to retain moisture in the sample. Groove the soil cake with the grooving tool through the centerline of the entire diameter using a maximum of six strokes. One stroke is either forward or backward. Only the last stroke may scrape the bottom of the cup. When properly placed in the cup and grooved, the soil cake will look like the illustrations in Figure 2.



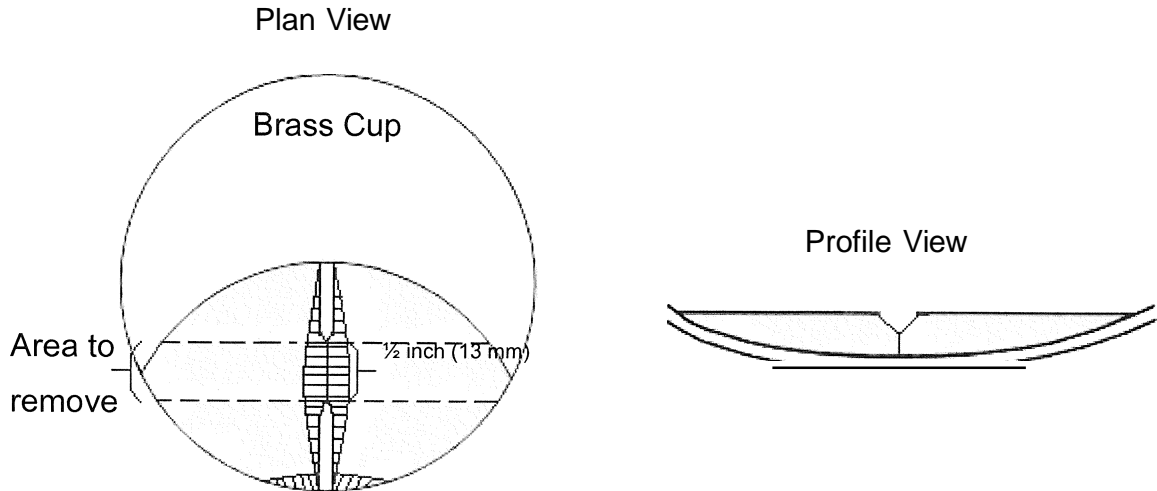

**Figure 3:** Soil Cake at Proper Groove Closure

9. Now turn the crank of the device at a speed of two revolutions per second, counting the number of blows (cup drops) required to close the groove for a distance of 1/2 in. (13 mm). Do not hold the base of the liquid limit device with your free hand.
10. The soil cake will look similar to the sketch in Figure 3 when the groove is properly closed.
11. After the groove closes, use the spatula to remove a section of the cake extending from edge to edge and perpendicular to the groove as shown in Figure 3. Include the portion with 1/2 in. groove closure. Immediately place the portion removed into a suitable container, cover and weigh. Record the number of blows and the weight to the nearest 0.01 g on the T307 and set aside.
12. Remove the remaining material from the cup and place back into the mixing dish. At this point, if you are conducting the plastic limit test in conjunction with the liquid limit test, remove approximately 10 g of material, roll into a ball and set aside to season until you are ready to begin the plastic limit test.
13. Wash and dry the cup and grooving tool in preparation for the next trial.

14. Add additional water, in 1 to 3 ml increments, to the material remaining in the mixing dish, remix and repeat the above steps for two additional trials. The first trial should fall between 25 and 35 blows, the second trial between 20 and 30 blows, and the third trial between 15 and 25 blows. The minimum range between the first and third trial should be 10 blows.
15. Dry specimens to a constant weight in an oven at  $230 \pm 9^{\circ}\text{F}$  ( $110 \pm 5^{\circ}\text{C}$ ) according to AASHTO T 265, removing lids for drying and replacing lids immediately after removing tins from oven.
16. Allow containers to cool long enough to handle safely. Weigh each one and record the weight to the nearest 0.01 g on the T307.

On the next page, 6-9, there is a copy of a T307 which has weights recorded from a three-point liquid limit test. Perform the calculations for the data given using the formulas at the bottom of the form and determine the moisture content for each point. The moisture content is recorded to the tenths (0.1) place to make an accurate flow curve. A completed T307 for this exercise can be found on page 6-10.

LIQUID/ PLASTIC LIMIT AND PLASTICITY INDEX

Lab Number		Project and Contract					Date Sampled				Transmit Date
Test Sequence	Material Code		Quantity			Item Number	Plant Source Code		Aggregate Source Code		
	Sieves:	1st	2nd	3rd	4th		5th	6th	7th	8th	No. 200
Design Number	Bitumen Content		Unit Weight		Face Fracture		LL	PL	PI		
	Target	Actual			%One	%Two					
AASHTO Size	Smallest Sieve 100%	Target A-bar	Actual A-bar	FA A-bar	CA No. 200	FA No.200	Total No. 200	P/F/N			

Technician \_\_\_\_\_ Date \_\_\_\_\_ Field Sample# \_\_\_\_\_

Source \_\_\_\_\_

**Report all masses to nearest 0.01 g.**  
**Calculate % of Water to nearest 0.1%.**

LIQUID LIMIT

		A	B	C	D	E	F	G
Dish No.	No. of Blows	Mass of Dish & Wet Soil	Mass of Dish & Dry Soil	Mass of Dish	Mass of Water	Mass of Dry Soil	% of Water	Liquid Limit
1	34	36.91	32.66	20.17				
2	27	32.80	29.35	19.85				
3	18	32.09	28.76	20.05				

PLASTIC LIMIT AND PLASTICITY INDEX

	H	K	L	M	N	p	R	S
Dish No.	Mass of Dish & Wet Soil	Mass of Dish & Dry Soil	Mass of Dish	Mass of Water	Mass of Dry Soil	% of Water	Plastic Limit	Plasticity Index
4	28.76	26.93	20.13					

Liquid Limit

D = A - B

E = B - C

F = (D / E) X 100

G = VALUE FROM FLOW CURVE (Nearest Whole No.) (3 pt. method)

G = F X (CORR. FACTOR) (Nearest Whole No.) (1 pt. method)

Plasticity Index

S = G - R

Plastic Limit

M = H - K

N = K - L

P = (M / N) X 100

R = P (Nearest Whole No.)

LIQUID/ PLASTIC LIMIT AND PLASTICITY INDEX

Lab Number		Project and Contract					Date Sampled			Transmit Date
Test Sequence	Material Code	C					Item Number	Plant Source Code	Aggregate Source Code	
		Quantity		Unit Weight	Face Fracture					
Sieves:	1st	2nd	3rd		4th	5th	6th	7th	8th	No.200
Design Number	Bitumen Content		Unit		Face Fracture		LL	PL	PI	
	Target	Actual	Weight	%One	%Two					
AASHTO Size	Smallest Sieve 100%	Target A-bar	Actual A-bar	FA A-bar	CA No.200	FA No. 200	Total No.200	P/F/N		

Technician, \_\_\_\_\_ Date \_\_\_\_\_ Field Sample# \_\_\_\_\_

Source \_\_\_\_\_

**Report all masses to nearest 0.01 g.**  
**Calculate % of Water to nearest 0.1%.**

LIQUID LIMIT

		A	B	C	D	E	F	G
Dish No.	No. of Blows	Mass of Dish & Wet Soil	Mass of Dish & Dry Soil	Mass of Dish	Mass of Water	Mass of Dry Soil	%of Water	Liquid Limit
1	34	36.91	32.66	20.17	4.25	12.49	34.0	
2	27	32.80	29.35	19.85	3.45	9.50	36.3	36
3	18	32.09	28.76	20.05	3.33	8.71	38.2	

PLASTIC LIMIT AND PLASTICITY INDEX

	H	K	L	M	N	p	R	S
Dish No.	Mass of Dish & Wet Soil	Mass of Dish & Dry Soil	Mass of Dish	Mass of Water	Mass of Dry Soil	%of Water	Plastic Limit	Plasticity Index
4	28.76	26.93	20.13	1.83	6.80	26.9	27	9

Liquid Limit

$D = A - B$

$E = B - C$

$F = (D / E) \times 100$

G = VALUE FROM FLOW CURVE (Nearest Whole No.) (3 pt. method)

G = F X (CORR. FACTOR) (Nearest Whole No.) (1 pt. method)

Plasticity Index

$S = G - R$

Plastic Limit

$M = H - K$

$N = K - L$

$P = (M / N) \times 100$

R = P (Nearest Whole No.)

### **The Flow Curve:**

Having completed the calculations, three moisture contents and their corresponding number of blows required to obtain the proper *groove* closure have been obtained. With this data, a "flow curve" can be plotted using single cycle semi-logarithmic graph paper (a copy can be found on the back of the T307). On page 6-13 is a copy of this type of graph paper completed with the values calculated in the previous example. The curve is prepared as follows:

1. First, set up the scales for the axes. The abscissa, or x-axis, represents the moisture contents and should increase in value from left to right. The range in moisture contents between the 1st and 3rd trials will dictate the scale for the axis. Usually a scale of 10 divisions equal to 1 percent will be sufficient to include the range of moisture contents for the three trials. The number of blows is represented on the ordinate, or y-axis, which is the logarithmic scale on this paper. A scale of 10 blows per each major division (dark line) should always be used, meaning 2 lines are equal to one blow. The bottom line will always start at 10 blows and the top line will indicate 100 blows.
2. The next step is to plot the values. The x and y coordinates are the moisture content and number of blows, respectively. In the previous example, the moisture content for the first trial was 34.0% and the number of blows was 34. To plot this point, first *move* right from the lower left-hand corner and find the vertical line that represents 34.0%. Then follow this line up until it intersects the horizontal line that represents 34 blows and plot the first point. Observe where this point has been plotted on page 6-13. The second and third points are plotted in the same manner.

3. Next, plot a best fit line or curve through all the plotted points. *A best fit line, or one that best fits the data, can be described as a straight line with the least amount of distance between all of the points and the line.* This best fit is plotted by drawing a line between the points such that the horizontal and vertical distances between the line and each point are as low as possible. This is the flow curve. Review the example on page 6-13 to see how this was completed.
  
4. Recall that the liquid limit is the moisture content at which the soil cake would have closed  $\frac{1}{2}$  in. (13 mm) at 25 blows. To find this moisture content, locate the 25 blows line on the y-axis. Next, draw a horizontal line until it intersects the flow curve. Draw a vertical line from this intersection to the x-axis and mark this value as the moisture content for 25 blows. Round this value to the nearest whole number and record it on the front of the T307. See how this value was determined on page 6- 13.

Review the completed flow curve on page 6-13 and note the steps described above.

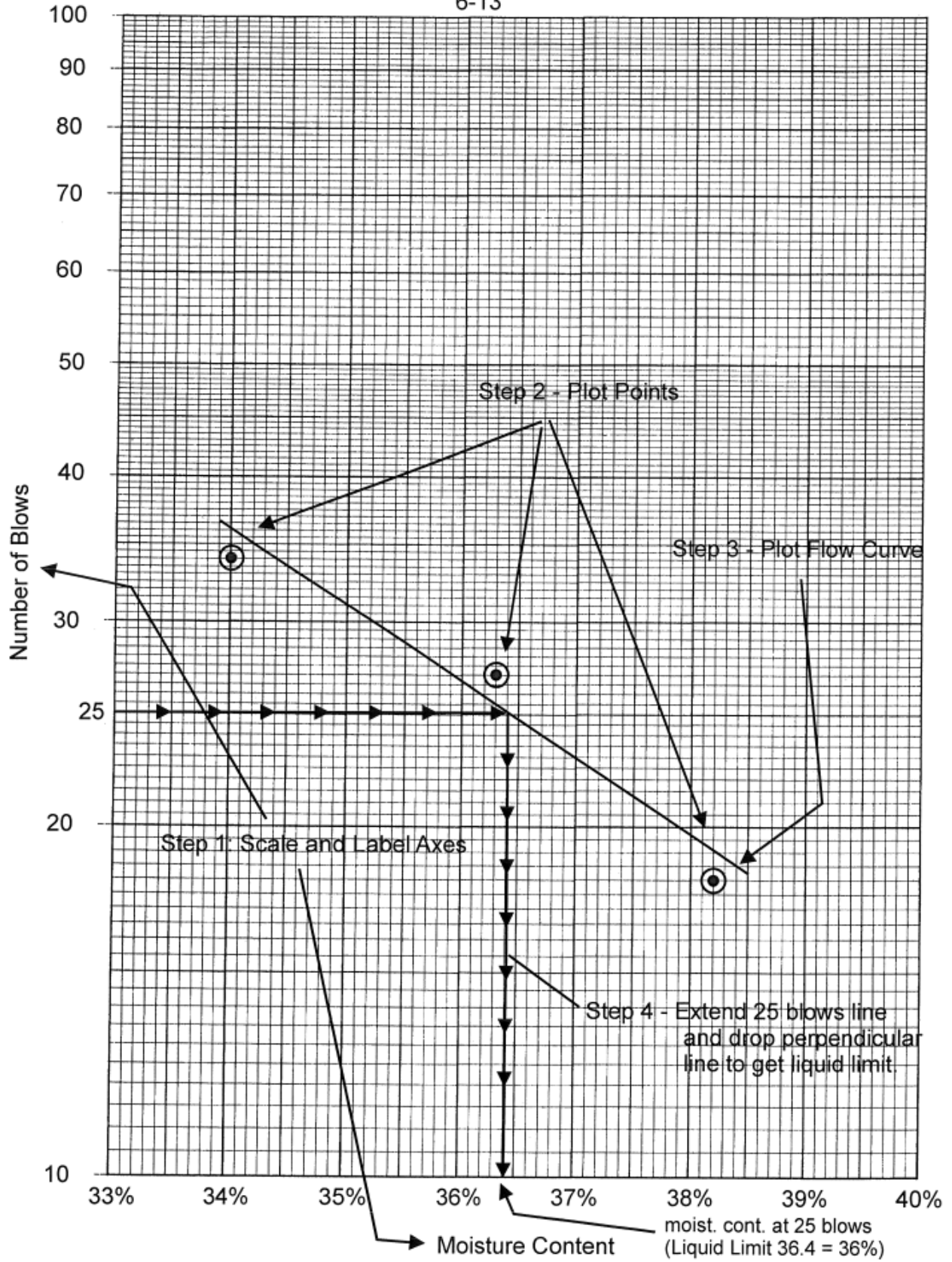

Now that the calculations in the first exercise have been reviewed, complete the two exercises with the test data in the tables below.

Exercise 2      Pg. 6-15 & 6-16

Dish#	# of Blows	Weight of Dish & Wet Soil	Weight of Dish & Dry Soil	Weight of Dish
1	35	41.99	37.26	20.36
2	24	37.97	33.99	20.36
3	17	39.16	34.82	20.62
4		28.81	27.41	20.32

The answer is located on pages 6-17 and 6-18.

Exercise 3      Pg. 6-19 & 6-20

Dish#	#of Blows	Weight of Dish & Wet Soil	Weight of Dish & Dry Soil	Weight of Dish
1	31	62.78	59.32	46.59
2	27	65.94	61.74	47.34
3	17	58.02	55.27	46.09
4		54.50	53.03	46.44

The answer is located on pages 6-21 and 6-22.

After completing the practice problems go to page 6-23.



LIQUID / PLASTIC LIMIT AND PLASTICITY INDEX

Lab Number		Project and Contract					Date Sampled			Transmit Date
Test Sequence	Material Code		C			Item Number	Plant Source Code		Aggregate Source Code	
	1st	2nd	Quantity	3rd	4th		5th	6th		7th
Sieves:	1st	2nd	3rd	4th	5th	6th	7th	8th	No. 200	
Design Number	Bitumen Content		Unit Weight		Face Fracture		LL	PL	PI	
		Target	Actual			%One	%Two			
AASHTO Size	Smallest Sieve 100%	Target A-bar		Actual A-bar	FA A-bar	CA No. 200	FA No. 200	Total No. 200		P/F/N

Technician \_\_\_\_\_ Date \_\_\_\_\_ Field Sample # \_\_\_\_\_

Source \_\_\_\_\_

Report all masses to nearest 0.01 g.  
Calculate % of Water to nearest 0.1%.

LIQUID LIMIT

		A	B	C	D	E	F	G
Dish No.	No. of Blows	Mass of Dish & Wet Soil	Mass of Dish & Dry Soil	Mass of Dish	Mass of Water	Mass of Dry Soil	% of Water	Liquid Limit
1								
2								
3								

PLASTIC LIMIT AND PLASTICITY INDEX

	H	K	L	M	N	P	R	S
Dish No.	Mass of Dish & Wet Soil	Mass of Dish & Dry Soil	Mass of Dish	Mass of Water	Mass of Dry Soil	% of Water	Plastic Limit	Plasticity Index
4								

Liquid Limit

D = A - B

E = B - C

F = (D / E) X 100

G = VALUE FROM FLOW CURVE (Nearest Whole No.) (3 pt. method)

G = F X (CORR. FACTOR) (Nearest Whole No.) (1 pt. method)

Plasticity Index

S = G - R

Plastic Limit

M = H - K

N = K - L

P = (M / N) X 100

R = P (Nearest Whole No.)

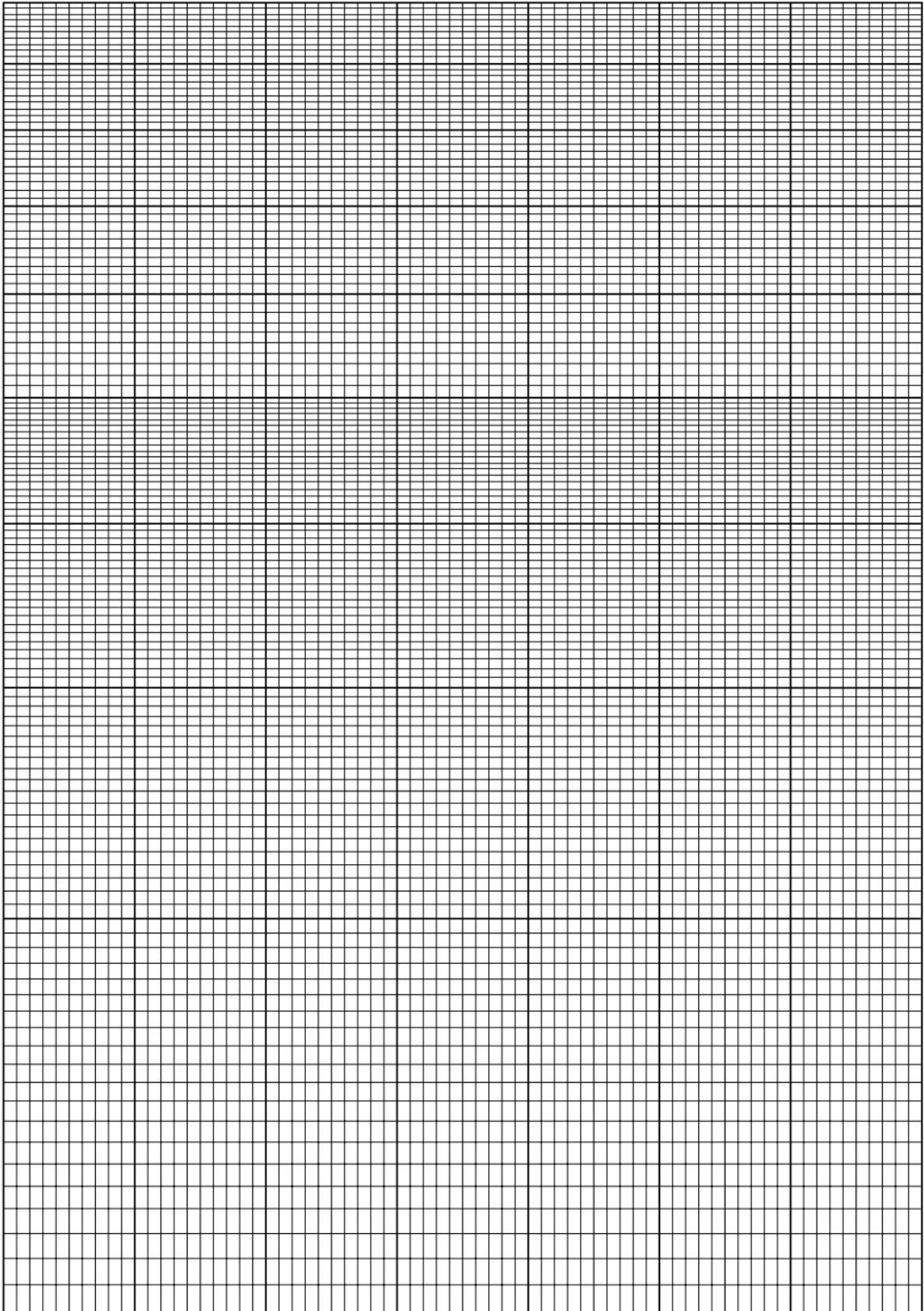

LIQUID / PLASTIC LIMIT AND PLASTICITY INDEX

Lab Number		Project and Contract				Date Sampled				Transmit Date
Test Sequence	Material Code	C				Item Number	Plant Source Code	Aggregate Source Code		
		Quantity	Quantity	Quantity	Quantity			Quantity	Quantity	
Sieves:	1st	2nd	3rd	4th	5th	6th	7th	8th	No. 200	
Design Number	Bitumen Content Target		Actual		Unit Weight	Face Fracture %One %Two		LL	PL	PI
AASHTO Size	Smallest Sieve 100%	Target A-bar		Actual A-bar	FA A-bar	CA No. 200	FA No. 200	Total No. 200	P/F/N	

Technician \_\_\_\_\_ Date \_\_\_\_\_ Field Sample # \_\_\_\_\_

Source \_\_\_\_\_

Report all masses to nearest 0.01 g.  
Calculate % of Water to nearest 0.1%.

LIQUID LIMIT

		A	B	C	D	E	F	G
Dish No.	No. of Blows	Mass of Dish & Wet Soil	Mass of Dish & Dry Soil	Mass of Dish	Mass of Water	Mass of Dry Soil	% of Water	Liquid Limit
1	35	41.99	37.26	20.36	4.73	16.90	28.0	
2	24	37.97	33.99	20.36	3.98	13.63	29.2	29
3	17	39.16	34.82	20.62	4.34	14.20	30.6	

PLASTIC LIMIT AND PLASTICITY INDEX

	H	K	L	M	N	P	R	S
Dish No.	Mass of Dish & Wet Soil	Mass of Dish & Dry Soil	Mass of Dish	Mass of Water	Mass of Dry Soil	% of Water	Plastic Limit	Plasticity Index
4	28.81	27.41	20.32	1.40	7.09	19.7	20	9

Liquid Limit

D = A - B

E = B - C

F = (D / E) X 100

G = VALUE FROM FLOW CURVE (Nearest Whole No.) (3 pt. method)

G = F X (CORR. FACTOR) (Nearest Whole No.) (1 pt. method)

Plasticity Index

S = G - R

Plastic Limit

M = H - K

N = K - L

P = (M / N) X 100

R = P (Nearest Whole No.)

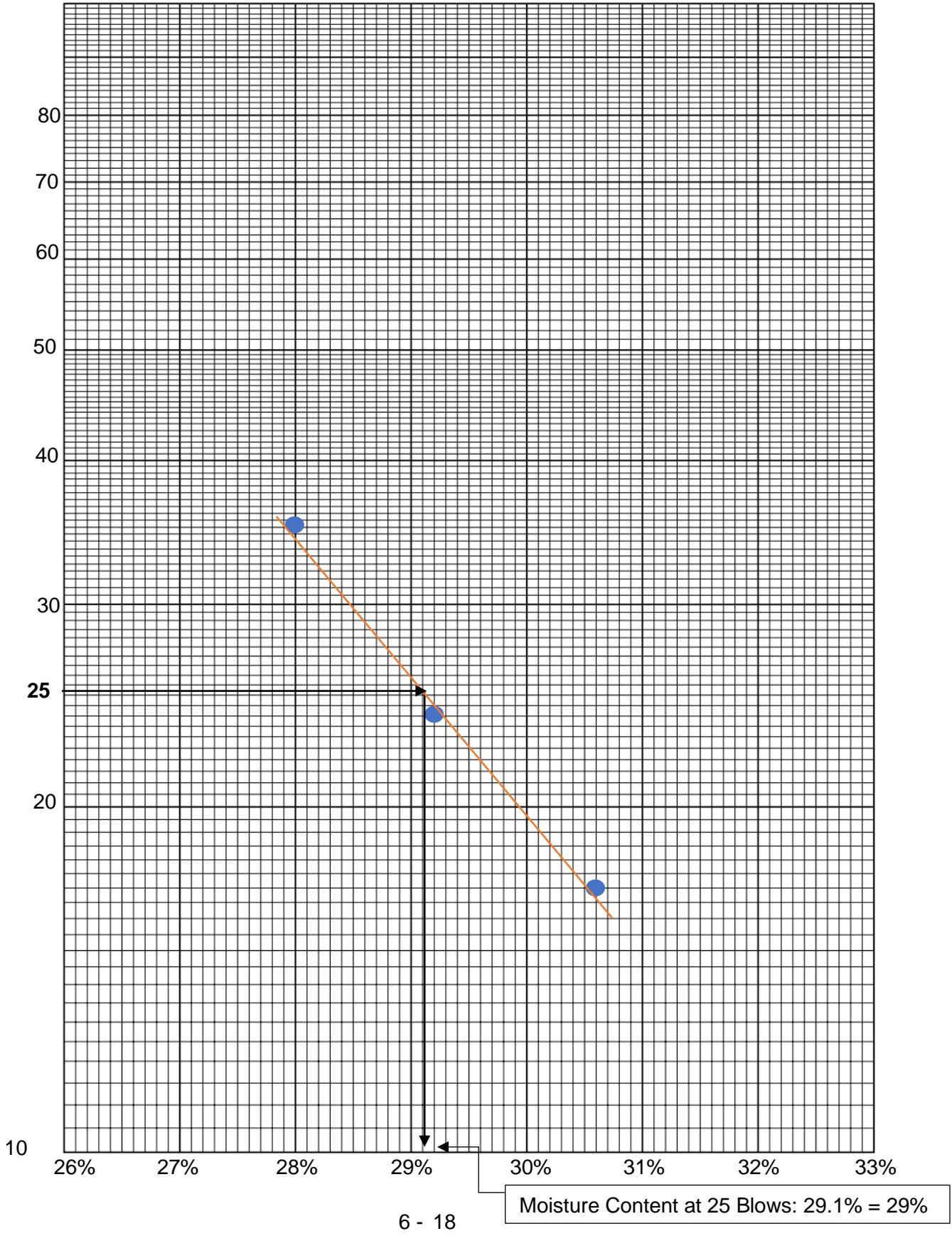

WEST VIRGINIA DIVISION OF HIGHWAYS  
MATERIALS CONTROL SOILS & TESTING DIVISION

LIQUID / PLASTIC LIMIT AND PLASTICITY INDEX

Lab Number		Project and Contract					Date Sampled			Transmit Date
Test Sequence	Material Code	C					Item Number	Plant Source Code	Aggregate Source Code	
		Quantity								
Sieves:	1st	2nd	3rd	4th	5th	6th	7th	8th	No. 200	
Design Number	Bitumen Content		Unit Weight		Face Fracture		LL	PL	PI	
	Target	Actual			%One	%Two				
AASHTO Size	Smallest Sieve 100%	Target A-bar	Actual A-bar	FA A-bar	CA No. 200	FA No. 200	Total No. 200	P/F/N		

Technician \_\_\_\_\_ Date \_\_\_\_\_ Field Sample # \_\_\_\_\_

Source \_\_\_\_\_

Report all masses to nearest 0.01 g.  
Calculate % of Water to nearest 0.1%.

LIQUID LIMIT

		A	B	C	D	E	F	G
Dish No.	No. of Blows	Mass of Dish & Wet Soil	Mass of Dish & Dry Soil	Mass of Dish	Mass of Water	Mass of Dry Soil	% of Water	Liquid Limit

PLASTIC LIMIT AND PLASTICITY INDEX

	H	K	L	M	N	P	R	S
Dish No.	Mass of Dish & Wet Soil	Mass of Dish & Dry Soil	Mass of Dish	Mass of Water	Mass of Dry Soil	% of Water	Plastic Limit	Plasticity Index

Liquid Limit

D = A - B

E = B - C

F = (D / E) X 100

G = VALUE FROM FLOW CURVE (Nearest Whole No.) (3 pt. method)

G = F X (CORR. FACTOR) (Nearest Whole No.) (1 pt. method)

Plasticity Index

S = G - R

Plastic Limit

M = H - K

N = K - L

P = (M / N) X 100

R = P (Nearest Whole No.)

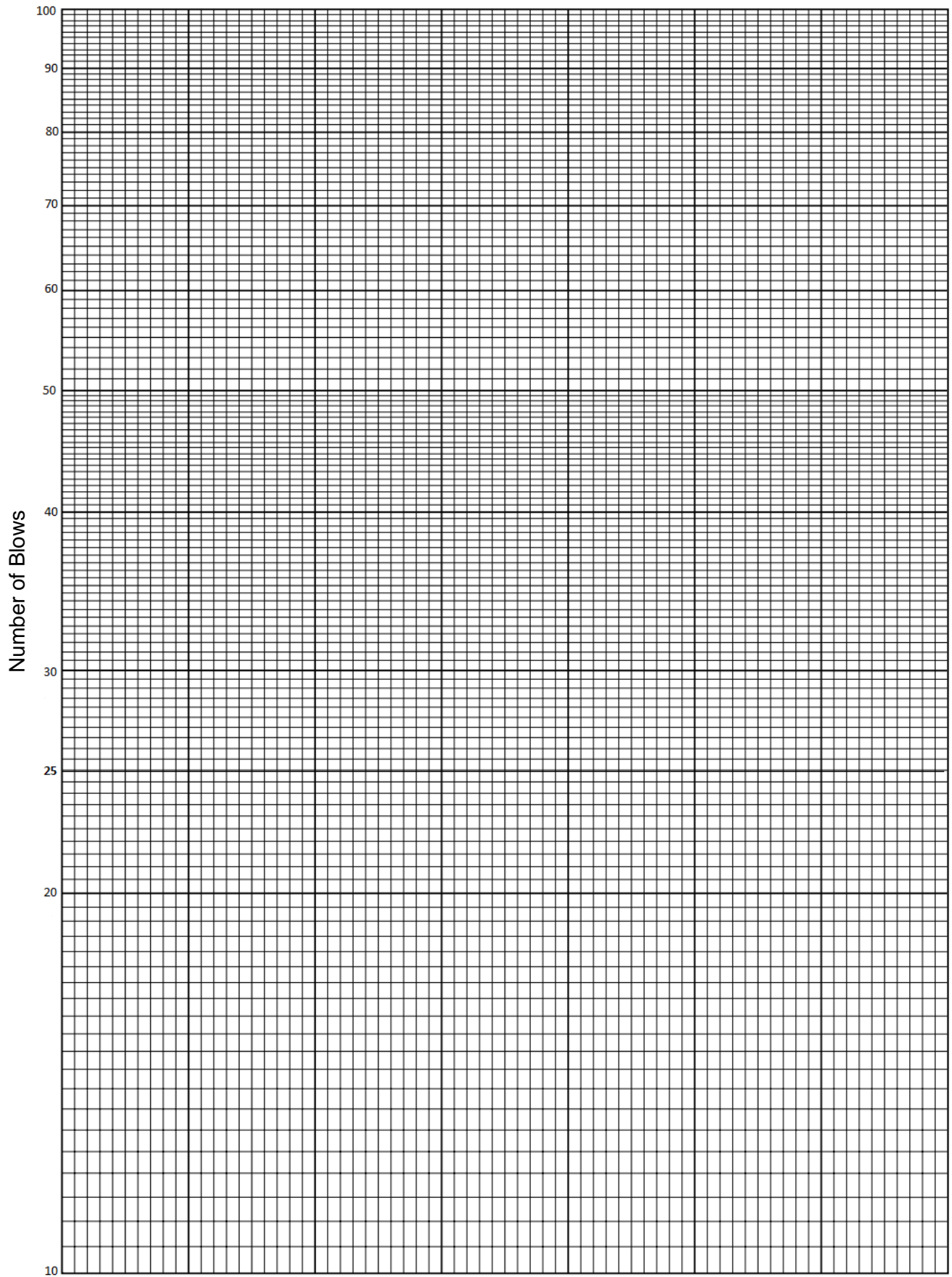

WEST VIRGINIA DIVISION OF HIGHWAYS  
MATERIALS CONTROL SOILS & TESTING DIVISION

LIQUID / PLASTIC LIMIT AND PLASTICITY INDEX

Lab Number		Project and Contract					Date Sampled			Transmit Date
Test Sequence	Material Code		C			Quantity	Item Number	Plant Source Code		Aggregate Source Code
	1st	2nd	3rd	4th	5th			6th	7th	
Design Number	Bitumen Content		Target	Actual	Unit Weight	Face %One	Fracture %Two	LL	PL	PI
AASHTO Size	Smallest Sieve 100%		Target A-bar		Actual A-bar	FA A-bar	CA No. 200	FA No. 200	Total No. 200	P/F/N

Technician \_\_\_\_\_ Date \_\_\_\_\_ Field Sample # \_\_\_\_\_

Source \_\_\_\_\_

Report all masses to nearest 0.01 g.  
Calculate % of Water to nearest 0.1%.

LIQUID LIMIT

		A	B	C	D	E	F	G
Dish No.	No. of Blows	Mass of Dish & Wet Soil	Mass of Dish & Dry Soil	Mass of Dish	Mass of Water	Mass of Dry Soil	% of Water	Liquid Limit
1	31	62.78	59.32	46.59	3.46	12.73	27.2	
2	27	65.94	61.74	47.34	4.20	14.40	29.2	29
3	17	58.02	55.27	46.09	2.75	9.18	30.0	

PLASTIC LIMIT AND PLASTICITY INDEX

	H	K	L	M	N	P	R	S
Dish No.	Mass of Dish & Wet Soil	Mass of Dish & Dry Soil	Mass of Dish	Mass of Water	Mass of Dry Soil	% of Water	Plastic Limit	Plasticity Index
4	54.50	53.03	46.44	1.47	6.59	22.3	22	7

Liquid Limit

D = A - B

E = B - C

F = (D / E) X 100

G = VALUE FROM FLOW CURVE (Nearest Whole No.) (3 pt. method)

G = F X (CORR. FACTOR) (Nearest Whole No.) (1 pt. method)

Plasticity Index

S = G - R

Plastic Limit

M = H - K

N = K - L

P = (M / N) X 100

R = P (Nearest Whole No.)



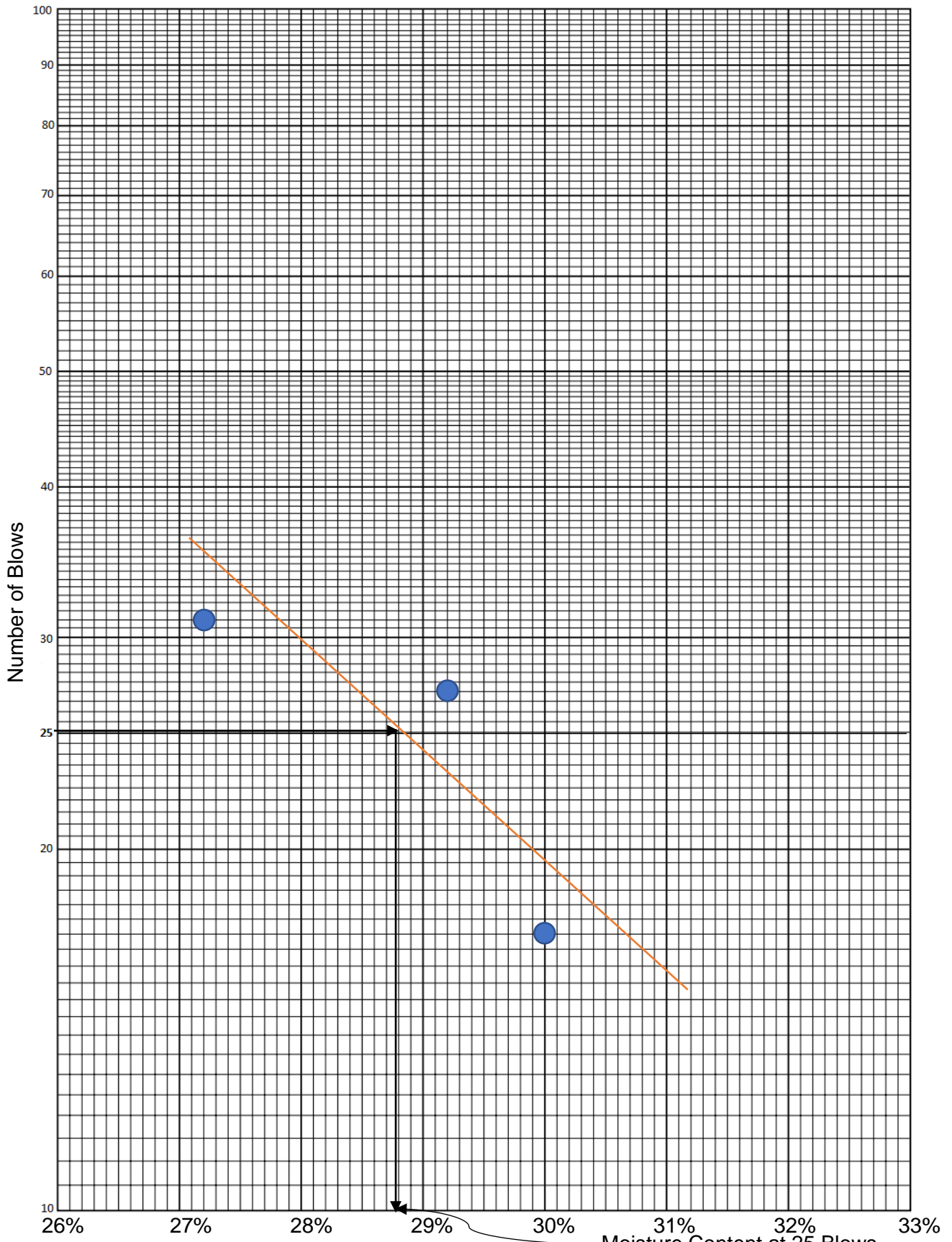

6 - 22

Moisture Content at 25 Blows  
28.8% → Liquid Limit is 29%



## **THE ONE POINT METHOD**

The one point method for determining the liquid limit is basically the same as the three-point method except that you start out with a 50 g sample and the initial addition of water is only 8 to 10 ml. However, one groove closure of 1/2 in. is obtained somewhere between 22 and 28 blows. Once this one groove closure occurs, immediately remove the soil from the cup, place it back into the evaporating dish and quickly mix it with the remaining material. The material is then placed in the cup of the device for another trial. If the second trial is within two blows of the first trial, then a portion of the soil cake is taken from the cup for moisture determination as in the three-point method. The percentage of water is the value that is necessary in this test.

Now that a groove closure between 22 and 28 blows has been obtained and the water content determined at that groove closure, the liquid limit needs to be determined.

Assume a groove closure at 22 blows and a moisture content of 20%. Determine what the moisture content would have been had for a groove closure at 25 blows. In the three-point method a flow curve was drawn from three points and from it the moisture content corresponding to 25 blows was determined. In the one point method, another procedure is needed.

Sections 11 through 14 of AASHTO T 89 further explain the one-point method. By applying a straightedge to the nomograph (Fig. 4 of the method reproduced on page 6-24), the liquid limit may be obtained. The correction factor method as described on page 6-25 may also be used or any other method that produces accurate liquid limit values.

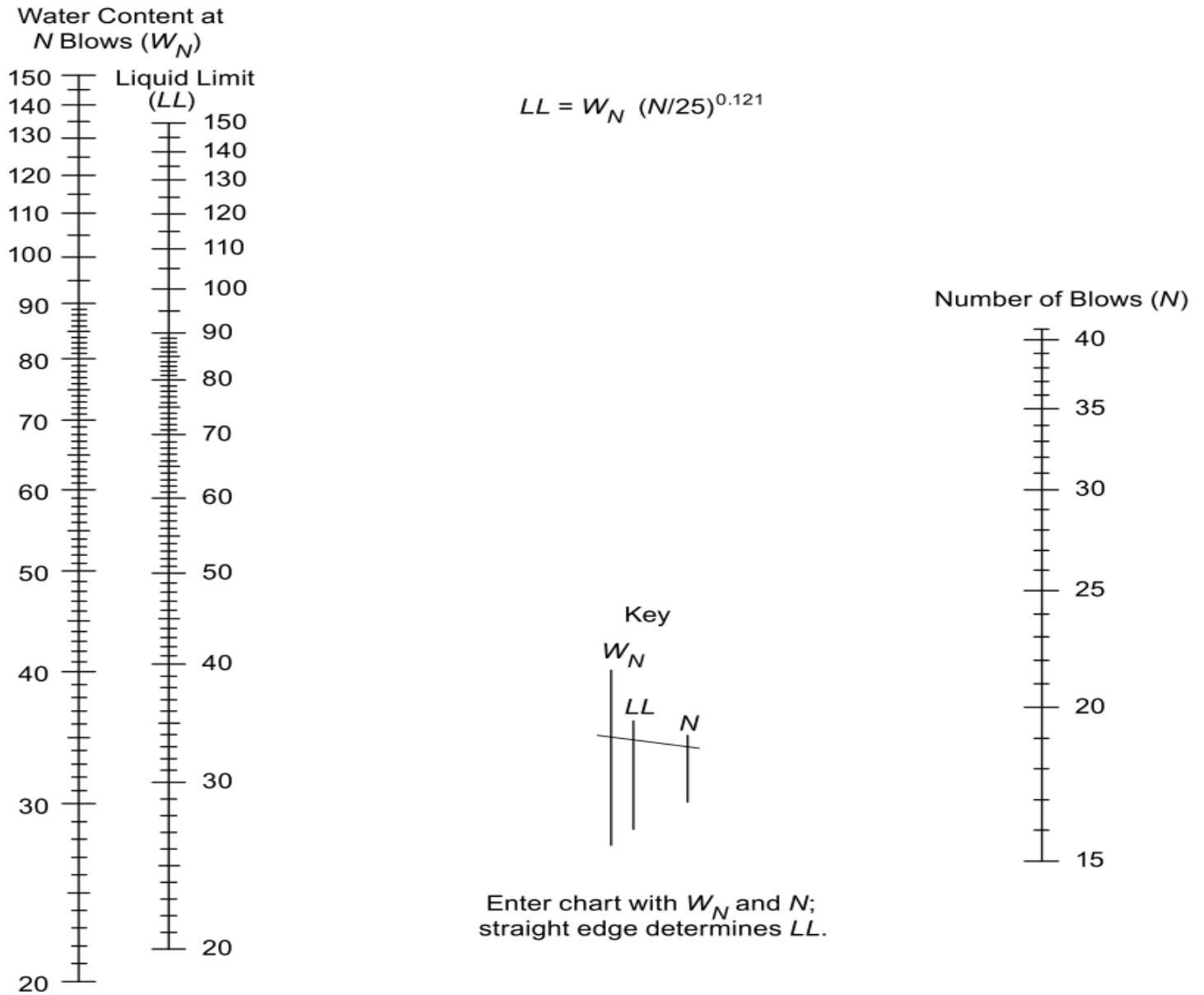

Nomographic chart Developed by the Waterways Experiment Station, Corps of Engineers, U.S. Army, to Determine Liquid Limit Using Mean Slope Method

Nomograph reproduced from AASHTO T 89

The correction factor method, Table 1, uses the moisture content of the liquid limit sample multiplied by a factor ( $k$ ) of the second closure blow count. Figure 5 was developed for the Calculation of the Liquid Limit.

$$LL = W^N (N/25)^{0.121}$$

or

$$LL = kW^N$$

where:

$N$  = number of blows causing closure of the groove at water content,

$LL$  = Liquid Limit corrected for closure at 25 blows,

$W^N$  = water content, and

$k$  = factor given in Table 1

**Table 1**-Factors for Obtaining Liquid Limit from Water Content and Number of Blows Causing Closure of the Groove

Number of blows, N	Factor for Liquid Limit, $k$
22	0.985
23	0.990
24	0.995
25	1.000
26	1.005
27	1.009
28	1.014

Recall that we had a groove closure at 22 blows and a moisture content of 20%. Using the nomograph on page 6-24, determine the liquid limit.

Number of Blows = 22

Moisture Content = 20%

Answer: Liquid Limit = 20

Using the correction factor method Table 1 on page 6-25:

$LL = \text{correction factor} \times \text{water content}$

$LL = 0.985 \times 20 = 19.7 = \text{Liquid Limit of 20}$

Now work the following problems. The answers are at the bottom of the page. Cover the answers with a sheet of paper until the problems are completed.

(1) Number of Blows = 28

Moisture Content = 40%

(2) Number of Blows = 24

Moisture Content = 25%

Answers

(1)  $LL = 41$

(2)  $LL = 25$

## II. PLASTIC LIMIT

The procedure used to determine the plastic limit of soils is AASHTO T 90. The plastic limit is the water content expressed as a percentage of the weight of oven dried soil at the boundary between the plastic and semi-solid states. This condition is arbitrarily defined as the lowest moisture content at which the soil can be rolled into threads 1/8 in. (3 mm) in diameter without the threads breaking into pieces.

The plastic limit test is more often conducted with the liquid limit test as its result is used in finding what we call the Plasticity Index. We will discuss the Plasticity Index later.

Before going further read AASHTO T 90.

The major items of equipment are listed below:

1. Porcelain evaporating dish about 4 ½ in. (115 mm) in diameter.
2. Spatula having a blade about 3 to 4 in. (75 to 100 mm) in length and ¾ inch (20 mm) in width.
3. Ground glass plate or smooth, unglazed paper on which to roll the sample.
4. Suitable containers which are corrosion resistant with close fitting lids to prevent moisture loss.
5. Balance that is sensitive to the hundredths place (0.01 g).
6. Oven capable of maintaining a temperature of  $230 \pm 9^{\circ}\text{F}$  ( $110 \pm 5^{\circ}\text{C}$ ).
7. A supply of distilled water.

If only the plastic limit is required, take approximately 20 g of the minus No. 40 material as prepared in AASHTO T 87, place it in a mixing dish and thoroughly mix with distilled water until the material becomes plastic enough to be easily shaped into a ball. Then remove about **10 g** for the test portion.

The remainder of the test is performed in the same manner as if run in conjunction with the liquid limit test. The container used for drying the material should be weighed and the weight recorded on the T307 to the nearest 0.01 g. First, remove a 1.5 - 2.0g portion of the sample. Next, shape the material into an ellipsoidal ball. Then roll the material between your fingers or palm and a ground glass plate or unglazed paper. Roll the material at a rate of about 80 or 90 strokes per minute. *One stroke is up and back.* Use just enough pressure to roll the material into a thread of uniform diameter throughout its length. The breaking point of the sample must not be manipulated by changing the hand pressure. Roll the material into a 1/8 in. (3 mm) thread within a **two-minute** time period, then reform the thread by squeezing together between thumbs and fingers, into a uniform mass, roughly ellipsoidal in shape. Repeat the preceding steps until the material crumbles before reaching a 1/8 in. (3 mm) diameter thread. Gather the crumbled pieces and place them into a pre-weighed container and cover. Repeat this process until the entire 10 g specimen has been tested. Once the plastic limit has been reached, we need to determine the moisture content at that condition. Weigh the container and sample and record the weight on the T307 to the nearest 0.01 g. Place the container in an oven at  $230 \pm 9^\circ \text{ F}$  ( $110 \pm 5^\circ \text{ C}$ ) with the lid removed and dry to a constant weight. When dry, remove the container and immediately replace the lid. Allow to cool and weigh. This weight is recorded on the T307 to the nearest 0.01 g.

Below are some additional questions that need to be answered when running the plastic limit test.

1. What should be done if the plastic limit sample cannot be rolled into a thread?
2. What is reported if the plastic limit exceeds the liquid limit?
3. What do you report if the liquid limit cannot be found?
4. With an extremely sandy material which should be performed first, the liquid or the plastic limit?

In the case of questions 1, 2, and 3, the material would be reported as being non-plastic (NP). An exception for question (1) would be if the plastic limit test was run in conjunction with the liquid limit test. Since the specimen has been allowed to season in air until completion of the liquid limit test, the sample may have prematurely lost too much moisture to be rolled out into a 1/8 in. (3 mm) thread. In this case some moisture must be added to the sample and again attempt to roll it out into the 1/8 in. (3 mm) thread. If the sample still crumbles before it can be rolled into the 1/8 in. (3 mm) thread, then it is considered to be non-plastic.

In the case of a very sandy material, conducting the plastic limit test first is wise because if the plastic limit is unattainable, the material would be non-plastic (NP), and would not require a liquid limit test.

Practice problems:

Given: Dry Weight of Soil = 6.52 g  
Weight of Water = 1.20 g

Find: Plastic Limit

Solution:

$$PL = \frac{1.20 \text{ g}}{6.52 \text{ g}} \times 100 = 18.4\%$$

$$PL = 18$$

Now work the following: Use the T307's that have already been used to determine the liquid limits from pages 6-9 to 6-21. Note where the data for exercise 1 has been recorded on the T307 on page 6-9 and follow this guide for the remainder of these exercises. **Caution: When calculating "PL", be sure to truncate the percent moisture to the 10th's place. This avoids rounding the same number twice as "R" is "P" rounded to the whole number.**

Exercise	Page#	Dish#	Weight of Dish & Wet Soil	Weight of Dish & Dry Soil	Weight of Dish	Answers
1	6-9	4	28.76	26.93	20.13	6-10
2	6-15	4	28.81	27.41	20.32	6-17
3	6-19	4	54.50	53.03	46.44	6-21



### **III. THE PLASTICITY INDEX**

As was noted earlier, the plasticity index is a value associated with the liquid limit and the plastic limit. It is also controlled by specifications governing the use of aggregate base course. Plasticity index specifications for stone and crushed aggregate are also found in Table 704.6.28 - Quality Requirements (page 1-24). The classes of aggregate which include base course material are allowed a maximum plasticity index of 6.

The plasticity index (P.I.) is the difference between the liquid and plastic limit. That is:

$$P.I. = L.L. - P.L.$$

Given a liquid limit of 28 and a plastic limit of 21 what is the plasticity index?

If you answered 7, you are correct.

Now complete the calculations for the plasticity Index for the exercises in which the liquid and plastic limits were determined. These exercises are found on pages 6-9, 6- 15, and 6-19. The answers for each are found on pages 6-10, 6-17, and 6-21, respectively.

On page 6-32 is a diagram showing the relationships between the Atterberg Limits. Notice the relationships between the ones that we have discussed - Liquid Limit, Plastic Limit, and Plasticity Index.

# ATTERBERG LIMITS AND SOIL STATES

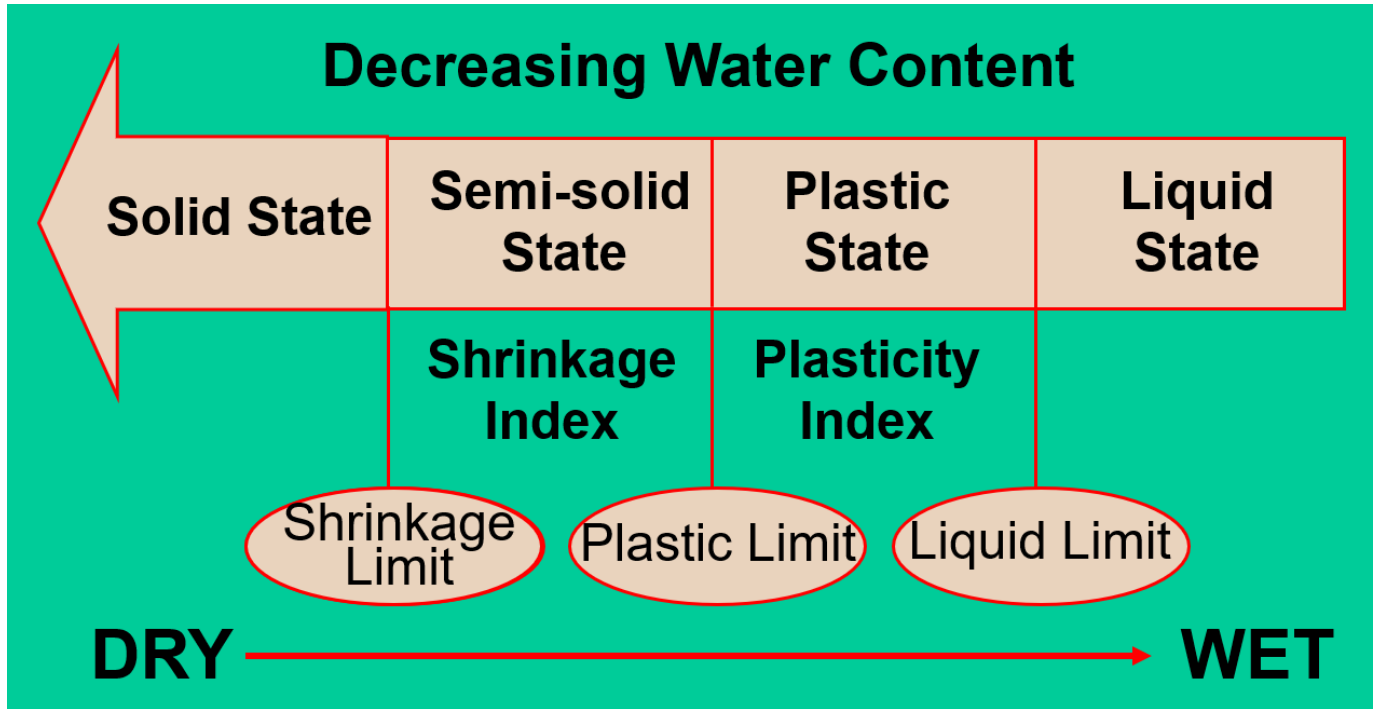

*Illustration of Atterberg Limits' Relationship to Water Content*

(This would conclude the chapter for Liquid and Plastic Limits. Find the answers to the 10 questions on Page 6-33 and mark or highlight the answers for easy retrieval during the written part of the Aggregate Technician Exam.)

## **CHAPTER 6: STUDY QUESTIONS**

1. What size material (Binder soil) is used for the Liquid and Plastic Limits?
2. What is the maximum Liquid Limit in stone and crushed aggregate?
3. How is the moisture content arbitrarily defined for Liquid Limit in the liquid limit device?
4. How would you use a mortar and rubber covered pestle in the 3-point method?
5. How deep should the thickness of the soil cake in your limit device be?
6. At what temperature do you dry the minus 40 sieve material before testing?
7. What do you do if you add too much water to your sample?
8. How many strokes of the grooving tool may be used during the Liquid Limit test?
9. At what stage of the Liquid Limit test is your sample for the Plastic Limit test removed from the Liquid Limit sample and set aside?
10. How many times must a Plastic Limit sample be rolled out to a 1/8" thread to be a valid test?



## CHAPTER 7

### PERCENT CRUSHED PARTICLES

This procedure is used to determine the percent of crushed particles in a sample. A crushed particle is defined as having at least one broken or fractured face created in the production process. Specifications concerning face fracture are outlined in the Standard Specifications Section 402, 703.2.2 and Section 704.6.2. The procedure for determining the percent crushed particles is outlined in MP 703.00.21 (page A-57 in the appendix).

This procedure is performed only on river gravel, which is a major constituent in highway construction. It is a naturally occurring aggregate and can, depending on its crushed or uncrushed state, be used in almost any design or item of construction. Natural river gravel is made up of well rounded particles due to the attrition and abrasion it receives on the river bottom. These well rounded particles reduce the surface area that can come into contact with an adjacent particle. Just as many marbles cannot be piled on top of one another, neither can many rounded gravel particles be piled on top of one another. On the other hand, material of sufficient angularity can be piled up. These particles tend to interlock with one another. After being mixed with the binding material (usually a bituminous pavement mixture) the interlocking effect of the crushed particles of gravel adds greater strength to the pavement. Because of the rounded shape, aggregate from a river gravel source usually requires crushing. There must be a means of measurement and control of the crushed particles to ensure adequate angularity and/or exposed surface area. The means of measurement is the percent crushed particles test.

Simply defined, **a face fracture** is a break (or broken face) that has resulted from the production process, which constitutes an area of **at least 25%** of the largest projected cross-sectional area of the particle remaining. A broken face, from the crushing

process, will usually have more angular and distinct edges than a broken area with edges created and rounded by natural processes. Often a freshly broken face will have a slightly different texture than the remaining unbroken faces in that it will have a different gloss or have more grainy texture. As the crushed gravel is stockpiled and transported, edges on the newly broken face may become slightly rounded but will still usually be more angular than edges on the unbroken faces. One helpful practice to decide if a broken face constitutes 25% of the projected two dimensional area of the particle is to draw two perpendicular lines along the longest dimensions of the projected area of the particle, splitting it into approximate quarters. Then, compare the broken face size with the size of the quarters. If the broken face size is equal to or larger than that of the quarter, then the particle would be judged to have one-face fracture (see the third example on the next page). The same would apply to multi-face fracture particles. As stated in the first paragraph a crushed particle has at least one fractured face.

To clarify this, here are some examples. The first example is one with no face fracture. The particle is well rounded with no break or fracture with sharp edges. This particle would be judged "no face" fracture.

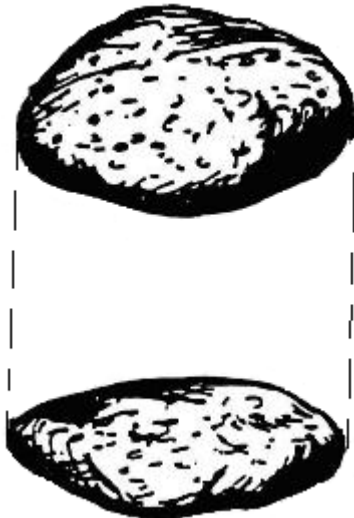

The second example also exhibits "no face" fracture. The particle is broken at a point; however, it does not meet or exceed those limits set up in the definition of face fracture. This particle is a pseudo-face fracture and therefore judged "no face" fracture.

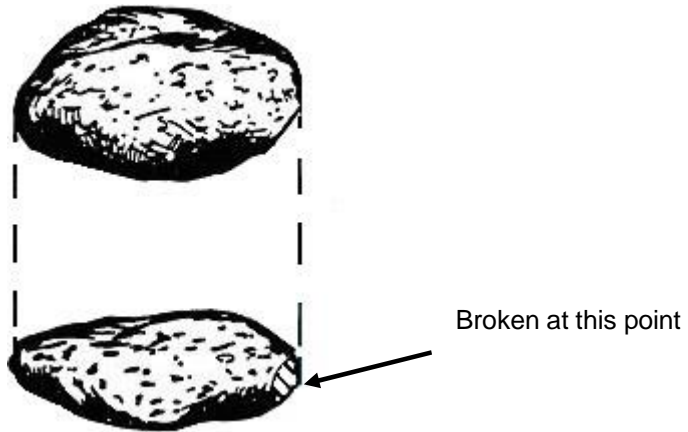

The third example has one face fracture and the break or fracture clearly meets the above definition. This particle is judged "one face" fracture.

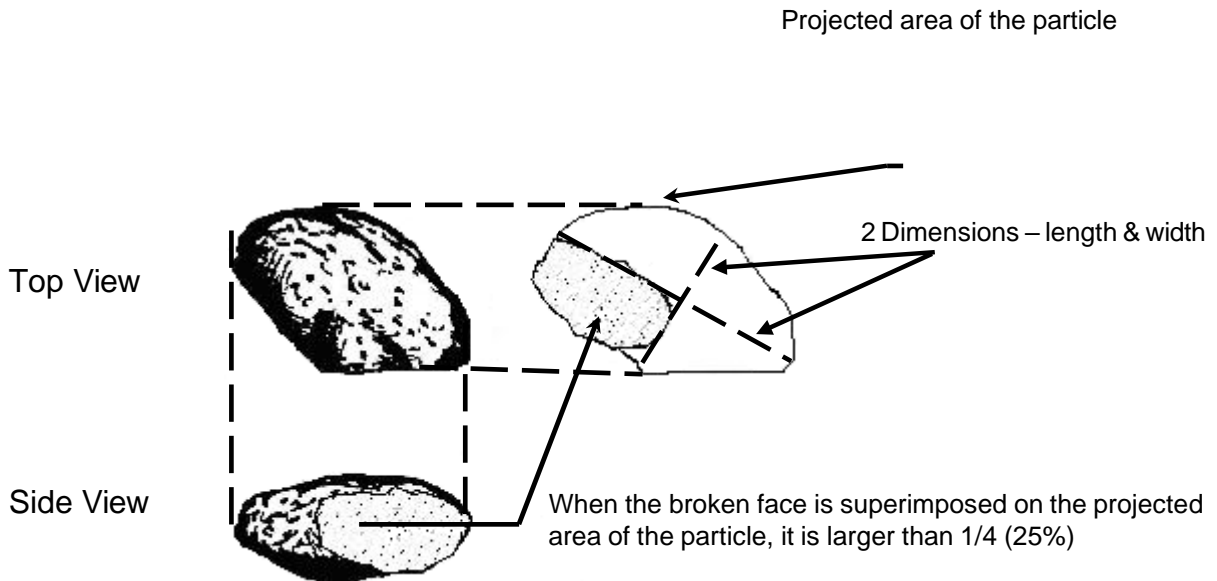

The fourth example has two face fractures, and both breaks clearly meet the above definition. This is considered two or more breaks or a multi-face fracture. Multi-face fractures must be oriented along separate planes.

This particle could be judged "two face" fracture or "multi-face" fracture.



Without looking back to the definition and examples, what is the next example?



It is a "one face" fracture or is it a "two face" fracture?



The percent crushed particles test is a means of determining, by percentages, the ratio of the weight of crushed particles to the weight of all the particles in a sample. A sample weighing 5000 g, is determined to have 2500 g of crushed particles. The equation is as follows:

$$\text{Percent Crushed Particles} = \frac{\text{Wt. of Crushed Particles}}{\text{Total Wt. of Sample}} \times 100$$

$$\text{Percent Crushed Particles} = \frac{2500 \text{ g}}{5000 \text{ g}} \times 100 = 50\%$$

$$\text{Percent Crushed Particles} = 50\%$$

Out of the total sample, 50% or one half the weight of the particles were crushed. Remember the definition of crushed particles and its application to face fracture.

In certain instances, specifications dictate single face requirements, meaning all particles having at least one face fracture. This includes both “one face”, and “two or more face” fracture particles. The percentage of all these combined may be referred to as the percent of total crushed particles. Where specifications define the percent of two face fracture particles, only include the weight of particles having two or more fractured faces.

Suppose a sample weighing 3000 g and is determined to have 2000 g of crushed particles. Which is the correct method to set up the following equation?

$$\frac{? \text{ g}}{? \text{ g}} \times 100\% = ?$$

Answer: \_\_\_\_\_

During the percent crushed particles test, the crushed particles are divided into three separate groups: "one face" fracture, "two or more face" fractures and "no face" fractures. Consider a sample with a total sample weight of  $W_5$ . This sample has a weight of  $W_1$ , ("two or more face" fractures),  $W_2$ , ("one face" fracture), and  $W_3$ , ("no face" fracture). Combine  $W_1$  and  $W_2$  to measure all the crushed particles regardless of their face fracture. This will generate weight  $W_4$ .

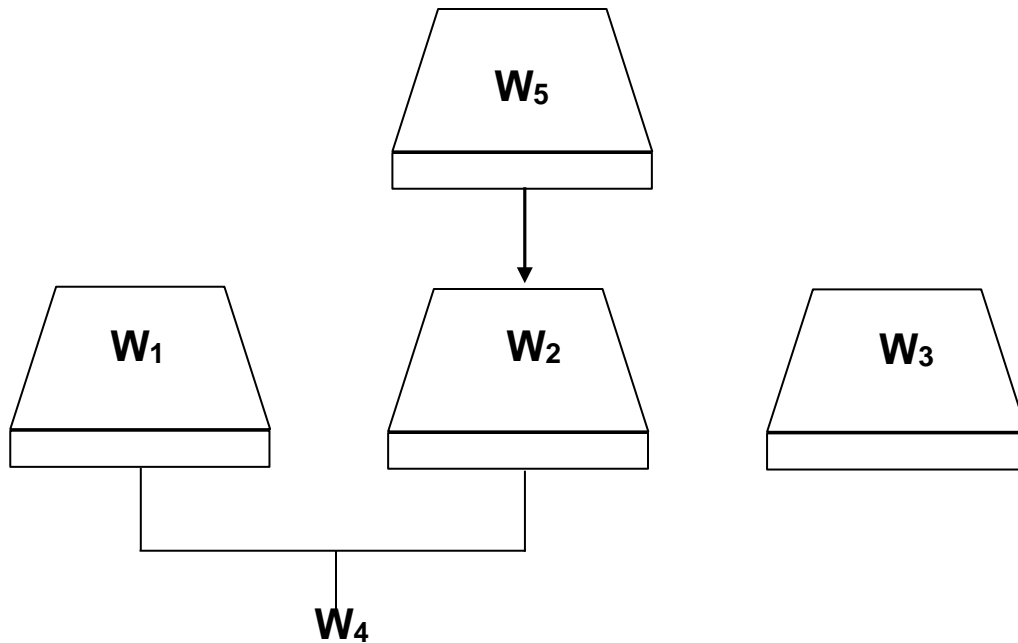

If  $W_5 = 3500 \text{ g}$   
 $W_1 = 2500 \text{ g}$   
 $W_2 = 500 \text{ g}$   
 $W_4 = W_1 + W_2$   
 $W_4 = 2500 \text{ g} + 500 \text{ g}$   
 $W_4 = 3000 \text{ g}$

Calculate the percent of total crushed particles.

Answer: \_\_\_\_\_

From the illustration and data on Page 7-6 calculate the percent of "two or more face" fractures.

Answer: \_\_\_\_\_

Understanding the calculations is essential. Correctly identifying the crushed particles in a sample is the most difficult part of this test. To do this, the entire test portion is separated into pans by face fracture type, "**no face**", "**one face**", and "**two or multi-face**". Because each decision is made from visual observation only, the test is somewhat subjective. Due to the subjective nature of the test, the sample is tested, and calculations are completed by two technicians. It is not likely that any two technicians conducting the test report exactly the same percentages. There is a maximum difference of **2%** allowed between the two technicians results for the test to be valid. If this maximum difference is exceeded, the procedure and identification criteria should be reviewed, and the test is to be conducted again by both technicians.

Let us now review, and at the same time, add the necessary procedure for completion of the percent crushed particles test, starting with Section 5.0 of the MP on page A-59.

The sample is received and has a weight of 75 to 100 lb (34 to 45 kg). MP703.00.21 states that the sample needs to be split down to an appropriate weight depending on the nominal maximum size of the aggregate. See the table on page 7-8 for approximate test portion sizes. After checking MP703.00.21, the sample is split, put into an oven and dried to a constant weight. The test sample needs to be at a constant weight because the results are based on the total weight and the weight of the separated portions. When the sample has dried and cooled, continue the test by sieving the sample over a No. 4 (4.75 mm) sieve. Discard the minus No. 4 (4.75 mm) material. This procedure eliminates all the small particles that would otherwise be impossible to test for face fracture. The plus No. 4 (4.75 mm) sieve material represents our test portion and it is weighed and recorded as the "Initial Mass" for technician one

on the Form T302. The T302 is the form for calculating percent face fracture for aggregate samples. A copy of this form can be seen on page 7-11.  $W_5$  is the initial mass on page 7-6.

**APPROXIMATE WEIGHT OF TEST PORTION OF CRUSHED GRAVEL**

(Section 5.2 of MP 703.00.21)

<u>NOMINAL MAXIMUM SIZE OF PARTICLE</u>	<u>WEIGHT OF TEST PORTION</u>
3/8 in. (9.5 mm)	500 g
3/4 in. (19.0 mm)	1500 g
1 in. (25.0 mm)	2000 g
1 1/2 in. (37.5 mm)	3000 g
Over 1 1/2 in. (over 37.5 mm)	5000 g

After preparations, determine the initial sample weight  $W_5$  and record it to the nearest whole gram (1g). The prepared test portion should be placed into a large flat container so each particle can be viewed with ease. Each particle is inspected and put into a separate container representing the applicable classification of "no-face" fracture or "one-face" fracture or "two or more face" fractures, whichever the case may be. The separated fractions will be weighed to the nearest whole gram (1 g) and the weights,  $W_1$ ,  $W_2$  and  $W_3$  (Page 7-6), are recorded in the "0 Face", "1 Face", and "2 or More Face" spaces on the T302. Next, the corresponding percentages of the total sample can be determined by using the initial sample weight. By combining  $W_1$  and  $W_2$  the total percent of crushed particles can be determined for the sample. This weight is recorded in the "Total Crushed Particles" space on the T302. The percentages of the total sample are then calculated to the nearest tenth of a percent (0.1%) and recorded on the T302. This concludes the percent crushed particles test by the first technician.

As stated earlier, this test must be conducted by **two** different technicians. At this point, the entire test portion is recombined and given to the second technician, who then follows the same steps previously outlined, beginning with weighing the prepared test portion. After completion of the test by the second technician, the individual test results are compared. *If the two sets of results fall within **2%**, they are averaged and reported to the **nearest whole percent** at the bottom of the T302.* If not, the test sample is recombined and both technicians conduct the test again. The test is complete when both sets of results fall within the 2% range. The results are then averaged and reported to the **nearest whole number**. The reported results are then evaluated with the appropriate specification.

Complete the following exercises using the data in the tables below. Answers are found on pages 7-12, 7-14, and 7-16.

<b>Exercise 1</b>	AASHTO #67 gravel			
Page 7-22	<b>Initial Weight</b>	<b>0 Face</b>	<b>1 Face</b>	<b>2 Face</b>
<b>Technician 1</b>	1511 g	270 g	204 g	1037 g
<b>Technician 2</b>	1511 g	289 g	172 g	1050 g

<b>Exercise 2</b>	AASHTO #8 gravel			
Page 7-24	<b>Initial Weight</b>	<b>0 Face</b>	<b>1 Face</b>	<b>2 Face</b>
<b>Technician 1</b>	521 g	78 g	161 g	282 g
<b>Technician 2</b>	521 g	94 g	144 g	283 g

<b>Exercise 3</b>	AASHTO #8 gravel			
Page 7-26	<b>Initial Weight</b>	<b>0 Face</b>	<b>1 Face</b>	<b>2 Face</b>
<b>Technician 1</b>	532 g	84 g	153 g	295 g
<b>Technician 2</b>	532 g	78 g	161 g	293 g

**(This concludes the discussion of Percent Crushed Particles. Find the answers to the 10 questions on Page 7-17 and mark or highlight the answers for easy retrieval during the written part of the Aggregate Technician Exam.)**

T302E  
Rev. 1-05

WEST VIRGINIA DIVISION OF HIGHWAYS  
MATERIALS CONTROL SOILS & TESTING DIVISION  
FACE FRACTURE  
MP 703.00.21

Lab Number		Project and Contract					Date Sampled			Transmit Date
Test Sequence	Material Code	C					Item Number	Plant Source Code	Aggregate Source Code	
		Quantity								
Sieves:	1st	2nd	3rd	4th	5th	6th	7th	8th	No. 200	
Design Number	Bitumen Content		Unit		Face Fracture		LL	PL	PI	
	Target	Actual	Weight	%One	%Two					
AASHTO Size	Smallest Sieve 100%	Target A-bar	Actual A-bar	FA A-bar	CA No. 200	FA No. 200	Total No. 200	P/F/N		

Technician 1: \_\_\_\_\_ Technician 2: \_\_\_\_\_

Source \_\_\_\_\_ Date \_\_\_\_\_ Field Sample # \_\_\_\_\_

Technician 1. Initial Mass (Nearest 1g) \_\_\_\_\_ 1511

	Mass (Nearest 1g)	Percent of Sample (Nearest 0.1 %)
0 Face	_____	_____
1 Face	_____	_____
2 or More Face	_____	_____
Final Mass	_____	
Total Crushed Particles	_____	_____

Technician 2. Initial Mass \_\_\_\_\_

	Mass (Nearest 1g)	Percent of Sample (Nearest 0.1 %)
0 Face	_____	_____
1 Face	_____	_____
2 or More Face	_____	_____
Final Mass	_____	
Total Crushed Particles	_____	_____

Final Results	Tech 1	Tech 2	Difference (Must be 2% or less)	Average Results to Nearest 1 %
0 Face	_____	_____	_____	_____
1 Face	_____	_____	_____	_____
2 or More Face	_____	_____	_____	_____
Total Crushed Particles	_____	_____	_____	_____

T302E  
Rev. 1-05

WEST VIRGINIA DIVISION OF HIGHWAYS  
MATERIALS CONTROL SOILS & TESTING DIVISION  
FACE FRACTURE  
MP 703.00.21

Lab Number		Project and Contract					Date Sampled			Transmit Date
Test Sequence	Material Code	C					Item Number	Plant Source Code	Aggregate Source Code	
		Quantity								
Sieves:	1st	2nd	3rd	4th	5th	6th	7th	8th	No. 200	
Design Number	Bitumen Content		Unit		Face Fracture		LL	PL	PI	
	Target	Actual	Weight	%One	%Two					
AASHTO Size	Smallest Sieve 100%	Target A-bar	Actual A-bar	12 FA A-bar	69 CA No. 200	FA No. 200	Total No. 200		P/F/N	

Technician 1: \_\_\_\_\_ Technician 2: \_\_\_\_\_

Source \_\_\_\_\_ Date \_\_\_\_\_ Field Sample # \_\_\_\_\_

Technician 1.	Initial Mass (Nearest 1g)	1511	Mass (Nearest 1g)	Percent of Sample (Nearest 0.1 %)
	0 Face		270	17.9
	1 Face		204	13.5
	2 or More Face		1037	68.6
	Final Mass		1511	
	Total Crushed Particles		1241	82.1

Technician 2.	Initial Mass	1511	Mass (Nearest 1g)	Percent of Sample (Nearest 0.1 %)
	0 Face		289	19.1
	1 Face		172	11.4
	2 or More Face		1050	69.5
	Final Mass		1511	
	Total Crushed Particles		1222	80.9

<u>Final Results</u>	Tech 1	Tech 2	Difference (Must be 2% or less)	Average Results to Nearest 1 %
0 Face	17.9	19.1	1	18
1 Face	13.5	11.4	2	12
2 or More Face	68.6	69.5	1	69
Total Crushed Particles	82.1	80.9	1	82



T302E  
Rev. 1-05

WEST VIRGINIA DIVISION OF HIGHWAYS  
MATERIALS CONTROL SOILS & TESTING DIVISION  
FACE FRACTURE  
MP 703.00.21

Lab Number		Project and Contract					Date Sampled			Transmit Date
Test Sequence	Material Code	C					Item Number	Plant Source Code	Aggregate Source Code	
		Quantity								
Sieves:	1st	2nd	3rd	4th	5th	6th	7th	8th	No. 200	
Design Number	Bitumen Content		Unit Weight		Face Fracture		LL	PL	PI	
	Target	Actual	Target	Actual	%One	%Two				
AASHTO Size	Smallest Sieve 100%	Target A-bar	Actual A-bar	FA A-bar	CA No. 200	FA No. 200	Total No. 200	P/F/N		

Technician 1: \_\_\_\_\_ Technician 2: \_\_\_\_\_

Source \_\_\_\_\_ Date \_\_\_\_\_ Field Sample # \_\_\_\_\_

Technician 1.	Initial Mass (Nearest 1g) _____	Mass (Nearest 1g) _____	Percent of Sample (Nearest 0.1 %) _____
	0 Face	_____	_____
	1 Face	_____	_____
	2 or More Face	_____	_____
	Final Mass	_____	
	Total Crushed Particles	_____	_____

Technician 2.	Initial Mass _____	Mass (Nearest 1g) _____	Percent of Sample (Nearest 0.1 %) _____
	0 Face	_____	_____
	1 Face	_____	_____
	2 or More Face	_____	_____
	Final Mass	_____	
	Total Crushed Particles	_____	_____

<u>Final Results</u>	Tech 1	Tech 2	Difference (Must be 2% or less)	Average Results to Nearest 1 %
0 Face	_____	_____	_____	_____
1 Face	_____	_____	_____	_____
2 or More Face	_____	_____	_____	_____
Total Crushed Particles	_____	_____	_____	_____

T302E  
Rev. 1-05

WEST VIRGINIA DIVISION OF HIGHWAYS  
MATERIALS CONTROL SOILS & TESTING DIVISION  
FACE FRACTURE  
MP 703.00.21

Lab Number		Project and Contract					Date Sampled			Transmit Date
Test Sequence	Material Code	C					Item Number	Plant Source Code	Aggregate Source Code	
		Quantity								
Sieves:	1st	2nd	3rd	4th	5th	6th	7th	8th	No. 200	
Design Number	Bitumen Content		Unit Weight		Face Fracture		LL	PL	PI	
AASHTO Size	Smallest Sieve 100%	Target A-bar	Actual A-bar	Actual A-bar	29 FA A-bar	54 CA No. 200	FA No. 200	Total No. 200	P/F/N	

Technician 1: \_\_\_\_\_ Technician 2: \_\_\_\_\_

Source \_\_\_\_\_ Date \_\_\_\_\_ Field Sample # \_\_\_\_\_

Technician 1.	Initial Mass (Nearest 1g)	_____ 521 _____	Mass (Nearest 1g)	Percent of Sample (Nearest 0.1 %)
	0 Face	_____ 78 _____	_____ 15.0 _____	
	1 Face	_____ 161 _____	_____ 30.9 _____	
	2 or More Face	_____ 282 _____	_____ 54.1 _____	
	Final Mass	_____ 521 _____		
	Total Crushed Particles	_____ 443 _____	_____ 85.0 _____	

Technician 2.	Initial Mass	_____ 521 _____	Mass (Nearest 1g)	Percent of Sample (Nearest 0.1 %)
	0 Face	_____ 94 _____	_____ 18.0 _____	
	1 Face	_____ 144 _____	_____ 27.6 _____	
	2 or More Face	_____ 283 _____	_____ 54.3 _____	
	Final Mass	_____ 521 _____		
	Total Crushed Particles	_____ 427 _____	_____ 82.0 _____	

<u>Final Results</u>	Tech 1	Tech 2	Difference (Must be 2% or less)	Average Results to Nearest 1 %
0 Face	_____ 15 _____	_____ 18 _____	_____ 3 _____	_____ _____
1 Face	_____ 30.9 _____	_____ 27.6 _____	_____ 3 _____	_____ _____
2 or More Face	_____ 54.1 _____	_____ 54.3 _____	_____ 0 _____	_____ _____
Total Crushed Particles	_____ 85 _____	_____ 82 _____	_____ 3 _____	_____ _____

MUST BE RERUN

WEST VIRGINIA DIVISION OF HIGHWAYS  
MATERIALS CONTROL SOILS & TESTING DIVISION  
FACE FRACTURE  
MP 703.00.21

Lab Number		Project and Contract					Date Sampled			Transmit Date
Test Sequence	Material Code	C					Item Number	Plant Source Code	Aggregate Source Code	
		Quantity								
Sieves:	1st	2nd	3rd	4th	5th	6th	7th	8th	No. 200	
Design Number	Bitumen Content		Unit		Face Fracture		LL	PL	PI	
	Target	Actual	Weight	%One	%Two					
AASHTO Size	Smallest Sieve 100%	Target A-bar	Actual A-bar	FA A-bar	CA No. 200	FA No. 200	Total No. 200	P/F/N		

Technician 1: \_\_\_\_\_ Technician 2: \_\_\_\_\_

Source \_\_\_\_\_ Field Sample # \_\_\_\_\_

Technician 1. Initial Mass (Nearest 1g) \_\_\_\_\_ 1511

	Mass (Nearest 1g)	Percent of Sample (Nearest 0.1 %)
0 Face	_____	_____
1 Face	_____	_____
2 or More Face	_____	_____
Final Mass	_____	
Total Crushed Particles	_____	_____

Technician 2. Initial Mass \_\_\_\_\_

	Mass (Nearest 1g)	Percent of Sample (Nearest 0.1 %)
0 Face	_____	_____
1 Face	_____	_____
2 or More Face	_____	_____
Final Mass	_____	
Total Crushed Particles	_____	_____

Final Results	Tech 1	Tech 2	Difference (Must be 2% or less)	Average Results to Nearest 1 %
0 Face	_____	_____	_____	_____
1 Face	_____	_____	_____	_____
2 or More Face	_____	_____	_____	_____
Total Crushed Particles	_____	_____	_____	_____

WEST VIRGINIA DIVISION OF HIGHWAYS  
MATERIALS CONTROL SOILS & TESTING DIVISION  
FACE FRACTURE  
MP 703.00.21

Lab Number		Project and Contract					Date Sampled			Transmit Date
Test Sequence	Material Code	C					Item Number	Plant Source Code	Aggregate Source Code	
		Quantity								
Sieves:	1st	2nd	3rd	4th	5th	6th	7th	8th	No. 200	
Design Number	Bitumen Content		Unit		Face Fracture		LL	PL	PI	
		Target	Actual	Weight	%One	%Two				
AASHTO Size	Smallest Sieve	Target A-bar	Actual A-bar	30 FA A-bar	55 CA No. 200	FA No. 200	Total No. 200	P/F/N		

Technician 1: \_\_\_\_\_ Technician 2: \_\_\_\_\_

Source \_\_\_\_\_ Date \_\_\_\_\_ Field Sample # \_\_\_\_\_

Technician 1.	Initial Mass (Nearest 1g)	Mass (Nearest 1g)	Percent of Sample (Nearest 0.1 %)
	532		
		0 Face	15.8
		1 Face	28.8
		2 or More Face	55.5
		Final Mass	
		448	
		Total Crushed Particles	84.2

Technician 2.	Initial Mass	Mass (Nearest 1g)	Percent of Sample (Nearest 0.1 %)
	532		
		0 Face	14.7
		1 Face	30.3
		2 or More Face	55.1
		Final Mass	
		454	
		Total Crushed Particles	85.3

Final Results	Tech 1	Tech 2	Difference (Must be 2% or less)	Average Results to Nearest 1 %
0 Face	15.8	14.7	1	15
1 Face	28.8	30.3	2	30
2 or More Face	55.5	55.1	0	55
Total Crushed Particles	84.2	85.3	1	85

## **Chapter 7 Study Questions:**

1. On what type of material is the Crushed Particle test run?
2. What is a Face Fracture?
3. What percentage of particles must be crushed to meet west Virginia's specifications?
4. At what sieve is the sample separated into a test portion?
5. What happens to the material too small for the test portion?
6. In a multi-face fracture, what orientation must the multiple faces of the particle be?
7. Within what percentage must the two results run by different individuals be within each other?
8. Why should samples always be dried before testing?
9. What constitutes a face fracture?
10. At what temperature do you dry the sample before testing?



## **CHAPTER 8**

### **CONTROL CHARTS**

Of our study to this point has been concerned with the physical testing of the aggregate to come up with some test value. It is now time to consider what we're going to do with all the test results we have accumulated.

Many of the results may be passed on to our fellow technicians without any special evaluation on our part. For example, specific gravity, absorption, and unit weight would be of interest to a Portland Cement concrete technician for use in developing batch weights. Percent crushed particles would be of interest to a bituminous concrete technician. Limits may be compared to the specification requirements, and they either meet or they don't meet. We, as aggregate technicians, have completed our evaluation of these results when we have assured ourselves that they are accurate and truly representative of material we have sampled.

Gradations are the backbone of the aggregate technician's job. This is the aggregate characteristic most likely to change without warning and requires constant monitoring. The remainder of this chapter will deal with the methods and ground rules we will use to evaluate our gradation test results.

In order to complete this section, you will need a copy of the MP 300.00.51 (page A-20 in the appendix); pencils - black, red, blue, green and yellow; a piece of 10 x 10 graph paper; and a straight edge. Normally the paper would be 22 in. (560 mm) wide and about 30 in. (760 mm) long, but reduced paper has been provided in this chapter to complete the exercises.

MP 300.00.51 provides two methods to record and visualize your gradation results chronologically. The first method is by using paper charts and the second is by using

computer-generated charts. Both methods are linked, for the most part, by one basic set of construction and interpretation rules. Although the technician should be familiar with both methods, in this exercise we will be concerned only with the construction of paper charts.

Begin by carefully studying MP 300.00.51, excluding for the time being Section 4.2: *Computer Generated Charts*. When you feel you thoroughly understand the MP, continue with the exercise below.

You can now see that we will evaluate our gradation test results by drawing a picture of them, called a control chart. This will allow us to see, at a glance, exactly how the production process is progressing. With a simple statistic, the moving average, control charts can be used to forecast future production. Control charts can only be used for this purpose if they are constructed and maintained throughout production. Another reason for completing control charts is that quality control and acceptance plans for several different construction items require that control charts be current and available for viewing by project and FHWA personnel, as well as submitted upon project completion to Department personnel.

Let's practice drawing a control chart. Turn to Table 1 (page 8-6) for a list of data from a tested sample of a Class 5 aggregate. The first thing we need to know is which sieves are specified for a Class 5 aggregate and the specified percents passing for those sieves. From Table 704.6.2 in the Standard Specifications (Table 2 of Chapter 1, page 1-24 of this manual), we can see that a Class 5 aggregate requires the 2 in. (50 mm), No. 4 (4.75 mm), and No. 200 (75  $\mu$ m) sieves. A blank piece of 10 x 10 graph paper has been included as Figure 1 (page 8-7). Note that the paper has been reduced to fit in the manual. The typical size of the graph paper is 10 small blocks per 1 in. or each block is 1 in. x 1 in. According to the MP, a scale of 10% = 1 in. is typical for percent passing ranges of 10% or greater, meaning that each small block represents 1%. With the reduced graph paper in this manual, use a scale of 10 small



blocks = 1 in. or 1 in. between each heavy black line. This will mean that one small block will still represent 1%. Now turn back to MP 300.00.51, and begin to go through it again. In Subsection 4.2.2 we see that the item number and description of material shall be noted at the top of the chart. Note that this has already been done on Figure 1 (page 8-7).

## **CONTROL CHART**

### Class 5 Base Course Item 307001-001

Now set your scales according to Subsection 4.1.4 to 4.1.9. Since all our sieves have a specification range greater than 10%, we must use a vertical scale of 1 in. = 10% (1 small block = 1%). Find the intersection of the first heavy, horizontal line below the title with the second heavy vertical line approximately 20 blocks from the left edge of the paper. Beginning at this intersection, draw a heavy red line across the paper leaving 20 small blocks at the end. The room on each end is to allow for the scales which must be written on chart as per the MP. Since the 2 in. (50 mm) sieve requires 100% passing with no range, this single line will represent the 2 in. (50 mm) sieve fraction. We complete this line by drawing a red vertical arrow at each end and noting 2 in. (50 mm) outside, and labeling "100%" inside these arrows. See the example in MP 300.00.51.

Now look at the No. 4 (4.75 mm) sieve. Note it has a range of 30% to 90% (range of 60%) and will require 60 small blocks. Since we must leave at least 10 small blocks between sieves, we draw another heavy red line 10 small blocks below our 2 in. (50 mm) sieve line. This will be the upper limit, or 90%, line for the No. 4 (4.75 mm) sieve. Another heavy red line will be drawn for the lower 30% limit and will be located 60 small blocks (60%) below the 90% upper limit line (see Figure 2, page 8-10). Connect the ends with vertical, red arrows, and label the sieve size, percentages, and scale similar to the example in MP 300.00.51. Following the same procedure, locate the No. 200 (75  $\mu$ m) sieve limits.

Locating the caution zones (Subsections 4.1.10 and 4.1.11) is the next step. They are located parallel to the specification lines, at a distance of approximately 20% of the specification range from the top and bottom specification limits. Since the 2 in. (50 mm) sieve has no range, it has no caution zone, so we start with the No. 4 (4.75 mm) sieve. This sieve has a range of 30%-90%, or 60%. Multiply 60 by .20 (20%) to get 12%. Next subtract 12% from 90% and add 12% to 30%. The caution zones are then located at 78% (90-12) and 42% (30+12). Using a green pencil draw a horizontal dashed line at 78% and 42%. With the yellow pencil, lightly shade the area between the red and green lines. This represents the caution zone. Follow the same procedure for the No. 200 (75  $\mu$ m) sieve.

The control chart is now ready to receive test data. Compare the chart with Figure 2 (page 8-10) to be sure all information is properly located.

If the chart compares with Figure 2 (page 8-10), start plotting the test results from Table 1 (page 8-6). Starting with the blue pencil, make a dot on the first heavy vertical line to the right of the red vertical arrows at the percentages indicated for each sieve for sample No. C0-14578. Draw a small circle around each dot. The blue "0" symbol should be on the red line for the 2 in. (50 mm) sieve, at 65% for the No. 4 (4.75 mm) sieve, and at 8.8% for the No. 200 (75  $\mu$ m) sieve. At the bottom of the sheet, identify the heavy vertical line that the data was plotted on with the sample No., your name, and the date sampled. See Section 5.2.5 in the MP. This completes the plotting of C0-14578.

On the next heavy vertical line, plot the next set of results from sample C0-14579. Make a blue dashed line between the adjacent points, that is, 100 to 100, 65 to 74, and 8.8 to 10.4. Next calculate the statistic used in control charting, the moving average. The moving average can be calculated by adding the current results for a given sieve and dividing by the number of results for that sieve.

For the No. 4 (4.75 mm) sieve the results thus far are 65% and 74%, thus the moving average is:

$$\frac{65+74}{2} = 69.5 = 70\%$$

In addition, on the second vertical line, plot the moving average of the two tests, using a red ":" symbol. This symbol should be located at 70% on the No. 4 (4.75 mm) sieve and 9.6% on the No. 200 (75 µm) sieve.

Continue calculating and plotting the remainder of the moving data as just described. Note: after plotting the results of the third test, the average will be the moving average of all three tests. Begin connecting the averages with a solid red line. Remember according to the MP, the moving average is to be done on no more than the last 5 samples. Beginning with the 6th sample, the first result will be dropped, and the moving average will be calculated for samples 2 through 6. Thereafter, only the current sample and the preceding four will be used for the moving average.

There is a Division Acceptance Sample in this data set. Typically, field sample numbers for acceptance samples begin with an "M". According to Section 5.1.3 of MP307.00.50, Division Acceptance Samples are to be plotted as a red "O" symbol and are not connected to adjoining results. The results for this sample are not to be included in the calculation of the moving average.

Continue plotting until all individual and average results have been plotted on the chart. Now compare the chart with Figure 2 (page 8-10).

Now that values have been plotted, read through Section 6 of the MP, which outlines required action for various result scenarios. Indicate the required action based on the results of each sample in the space provided on page 8-8. If no action is required, write

"no action" in the space provided. If sublots are found to be non-conforming, price adjustments may be necessary. Section 307.9.1 in the January, 2003 Supplemental Specifications describes situations which requires price adjustments.

TABLE 1  
 DATA FOR PRACTICAL EXERCISE IN CONTROL CHARTING  
TEST RESULTS

Sieves:		2 in.	No. 4	Moving	No.200	Moving
Specifications:		100 %	30%-90%	Average	0%-25%	Average
Lab No.	<u>Date</u>					
C0-14578	07-06-06	100	65		8.8	
C0-14579	07-06-06	100	74		10.4	
C0-14580	07-07-06	100	83		14.2	
C0-14581	07-08-06	100	87		15.8	
C0-14583	07-08-06	100	91		12.3	
C0-14584	07-09-06	100	57		8.9	
C0-14585	07-09-06	100	55		13.2	
M0-12345	07-09-06	100	69	---	15.0	---
C0-14586	07-10-06	100	58		14.8	
C0-14587	07-11-06	100	55		18.4	

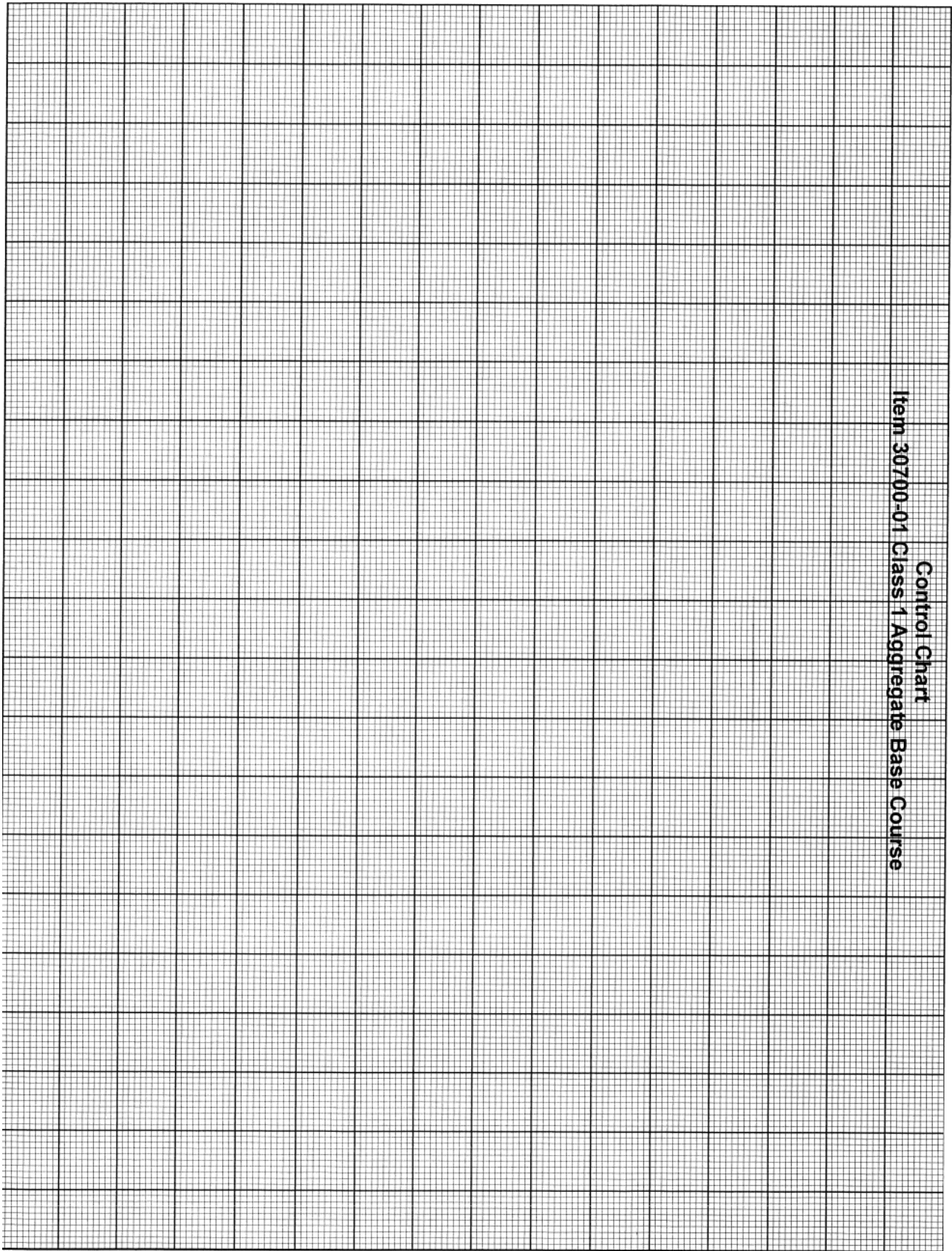

ACTION REQUIRED AS A RESULT OF  
GRADATION TESTING OF  
CLASS 5 AGGREGATE BASE COURSE (ITEM 307001-001)

LAB# & DATE:

ACTION:

C0-14578

C0-14579

C0-14580

C0-14581

C0-14583

C0-14584

C0-14585

C0-14586

C0-14587

Answers from example in Table 1 on page 8-6.

Sieves:		2 in.	No. 4	Moving	No. 200	Moving
Specifications:		100 %	30%-90%	Average	0%-25%	Average
Lab No.	<u>Date</u>					
C0-14578	07-06-06	100	65		8.8	
C0-14579	07-06-06	100	74	70	10.4	9.6
C0-14580	07-07-06	100	83	74	14.2	11.1
C0-14581	07-08-06	100	87	77	15.8	12.3
C0-14583	07-08-06	100	91	80	12.3	12.3
C0-14584	07-09-06	100	57	78	8.9	12.3
C0-14585	07-09-06	100	55	75	13.2	12.9
M0-12345	07-09-06	100	69	---	15.0	---
C0-14586	07-10-06	100	58	70*	14.8	13.0*
C0-14587	07-11-06	100	55	63	18.4	13.5

\*Remember, acceptance samples are not included in the calculation for the moving average.

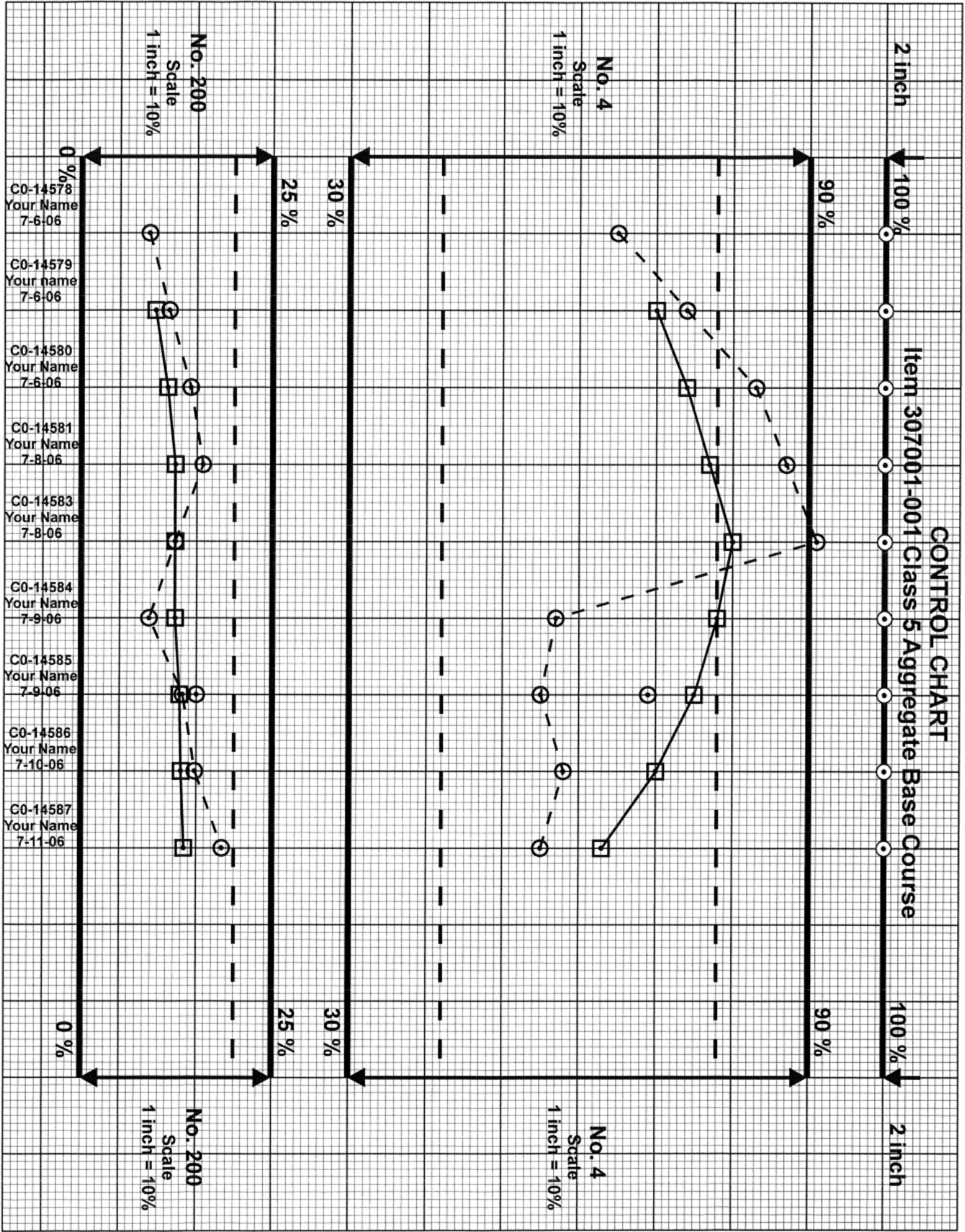



ACTION REQUIRED AS A RESULT OF  
GRADATION TESTING OF  
CLASS 5 AGGREGATE BASE COURSE (ITEM 307001-001)

LAB# & DATE:ACTION:

C0-14578	No action.
C0-14579	No action.
C0-14580	No action.
C0-14581	No action.
C0-14583	Individual results for the No. 4 (4.75 mm) sieve are outside specification limits and the moving average is in the caution zone, therefore the Project Engineer and the contractor should be advised that the material is borderline, and the following notation made in the plant diary. "Contractor advised that the Class 5 Aggregate Base Course is borderline. The contractor should also be advised to make changes to correct the problem.
C0-14584	This moving average for the No. 4 (4.75 mm) sieve is still in the caution zone, however, the individual result is well within specifications. It appears that the contractor has corrected the problem. Changes made at the plant should be reviewed to see if a new moving average should be started.
C0-14585	No action.
C0-14586	No action.
C0-14587	No action.

8-12

Using data from Table 2 complete a control chart using graph paper on page 8-13. After plotting each sample result check in the MP to see what action would need to be taken. Indicate what would be required in the provided space on pages 8-14 and 8-15. Turn to Figure 4 (page 8-17) and the following pages for a comparison of results.

TABLE 2  
Test Results for Class 1 Base Course (Item 307001-001)

Sieves:		1 ½ in.	¾ in.	Mov.	No.4	Mov.	No. 40	Mov.	No. 200	Mov.
Specs:		100 %	50%-90%	Avg.	20%-50%	Avg.	5%-20%	Avg.	0%-7%	Avg.
Lab No.	Date									
C0-35100	06-10-06	100	70		35		9		1.2	
C0-35101	06-11-06	100	72		30		10		3.4	
C0-35102	06-11-06	100	78		37		11		5.2	
C0-35103	06-12-06	100	80		40		15		2.4	
C0-35104	06-13-06	100	77		42		14		4.8	
C0-35105	06-17-06	100	83		45		13		1.5	
C0-35106	06-17-06	100	84		51		15		3.3	
M0-13458	06-17-06	00	82	---	49	---	12	---	3.8	---
C0-35107	06-18-06	100	92		53		12		4.7	
C0-35108	06-19-06	100	90		52		12		5.5	
C0-35109	06-19-06	100	88		45		10		3.9	
C0-35110	06-23-06	100	84		43		13		2.8	
C0-35111	06-24-06	100	87		42		12		4.2	
M0-13462	06-24-06	100	83	---	41	---	14	---	3.0	---
C0-35112	06-28-06	100	98		40		15		5.3	
C0-35113	06-28-06	100	99		43		16		1.4	
C0-35114	06-29-06	100	78		38		12		3.4	

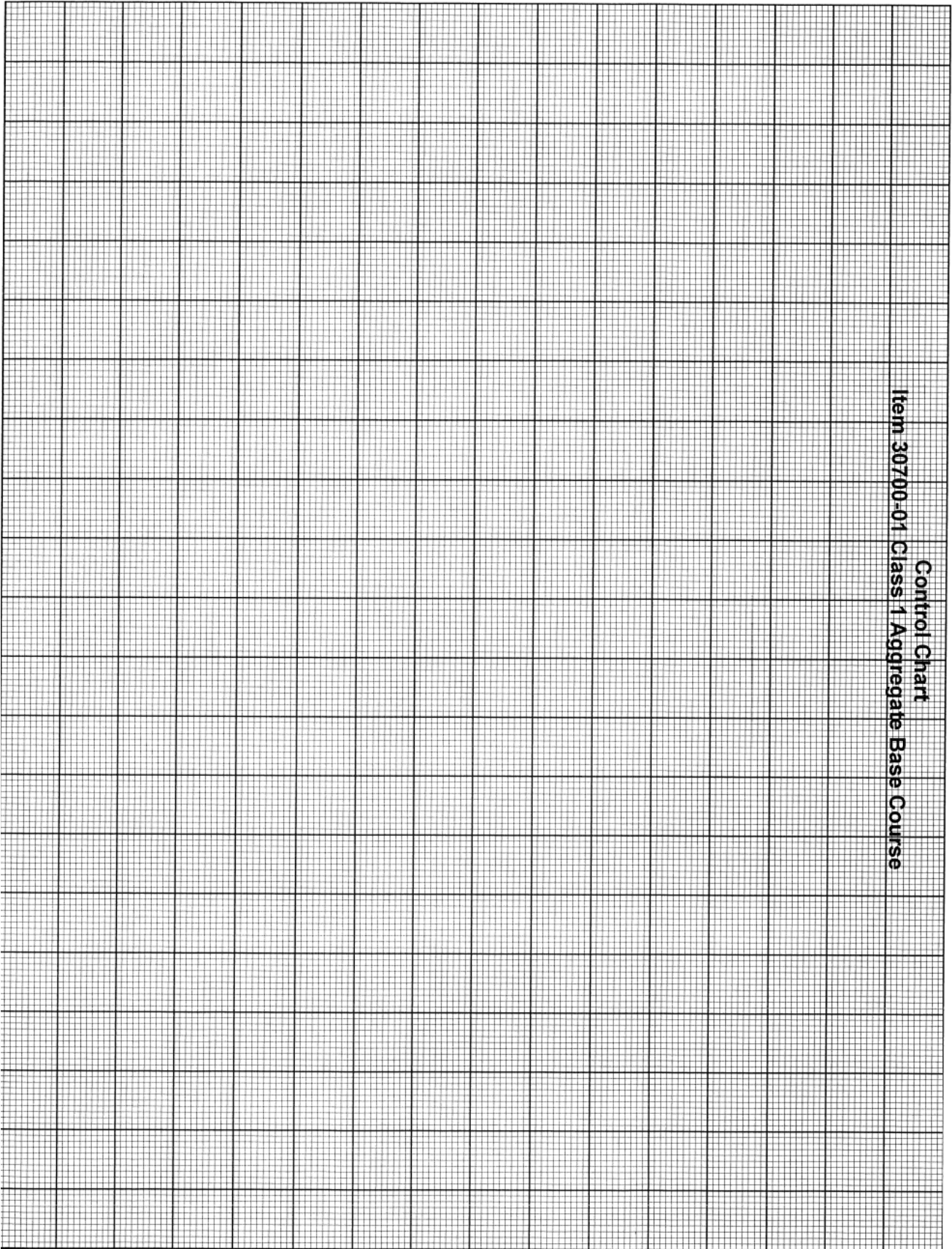

Control Chart  
Item 30700-01 Class 1 Aggregate Base Course

ACTION REQUIRED AS A RESULT OF  
GRADATION TESTING OF CLASS 1 BASE COURSE (ITEM 307001-001)

LAB# & DATE:

ACTION:

C0-35100

C0-35101

C0-35102

C0-35103

C0-35104

C0-35105

C0-35106

C0-35107

C0-35108

C0-35109

C0-35110

C0-35111

C0-35112

C0-35113

C0-35114

## 8-16

Answers for the example in Table 2 on page 8-12.

Sieves:		1 ½ in.	3/4 in.	Mov.	No. 4	Mov.	No. 40	Mov.	No.200	Mov.
Specs:		100%	50%-90%	Avg.	20%-50%	Avg.	5%-20%	Avg.	0%-7%	Avg.
Lab No.	Date									
C0-35100	06-10-06	100	70		35		9		1.2	
C0-35101	06-11-06	100	72	71	30	32	10	10	3.4	2.3
C0-35102	06-11-06	100	78	73	37	34	11	10	5.2	3.3
C0-35103	06-12-06	100	80	75	40	36	15	11	2.4	3.0
C0-35104	06-13-06	100	77	75	42	37	14	12	4.8	3.4
C0-35105	06-17-06	100	83	78	45	39	13	13	1.5	3.5
C0-35106	06-17-06	100	84	80	51	43	15	14	3.3	3.4
M0-13458	06-17-06	100	82	---	49	---	12	---	3.8	---
C0-35107	06-18-06	100	92	83*	53	46*	12	14*	4.7	3.3*
C0-35108	06-19-06	100	90	85	52	49	12	13	5.5	4.0
C0-35109	06-19-06	100	88	87	45	49	10	12	3.9	3.8
C0-35110	06-23-06	100	84	88	43	49	13	12	2.8	4.0
C0-35111	06-24-06	100	87	88	42	47	12	12	4.2	4.2
M0-13462	06-24-06	100	83	---	41	---	14	---	3.0	---
C0-35112	06-28-06	100	98	89*	40	44*	15	12*	5.3	4.3*
C0-35113	06-28-06	100	99	91	43	43	16	13	1.4	3.5
C0-35114	06-29-06	100	78	89	38	41	12	14	3.4	3.4

- Remember, acceptance samples are not included in the calculation for the moving average.

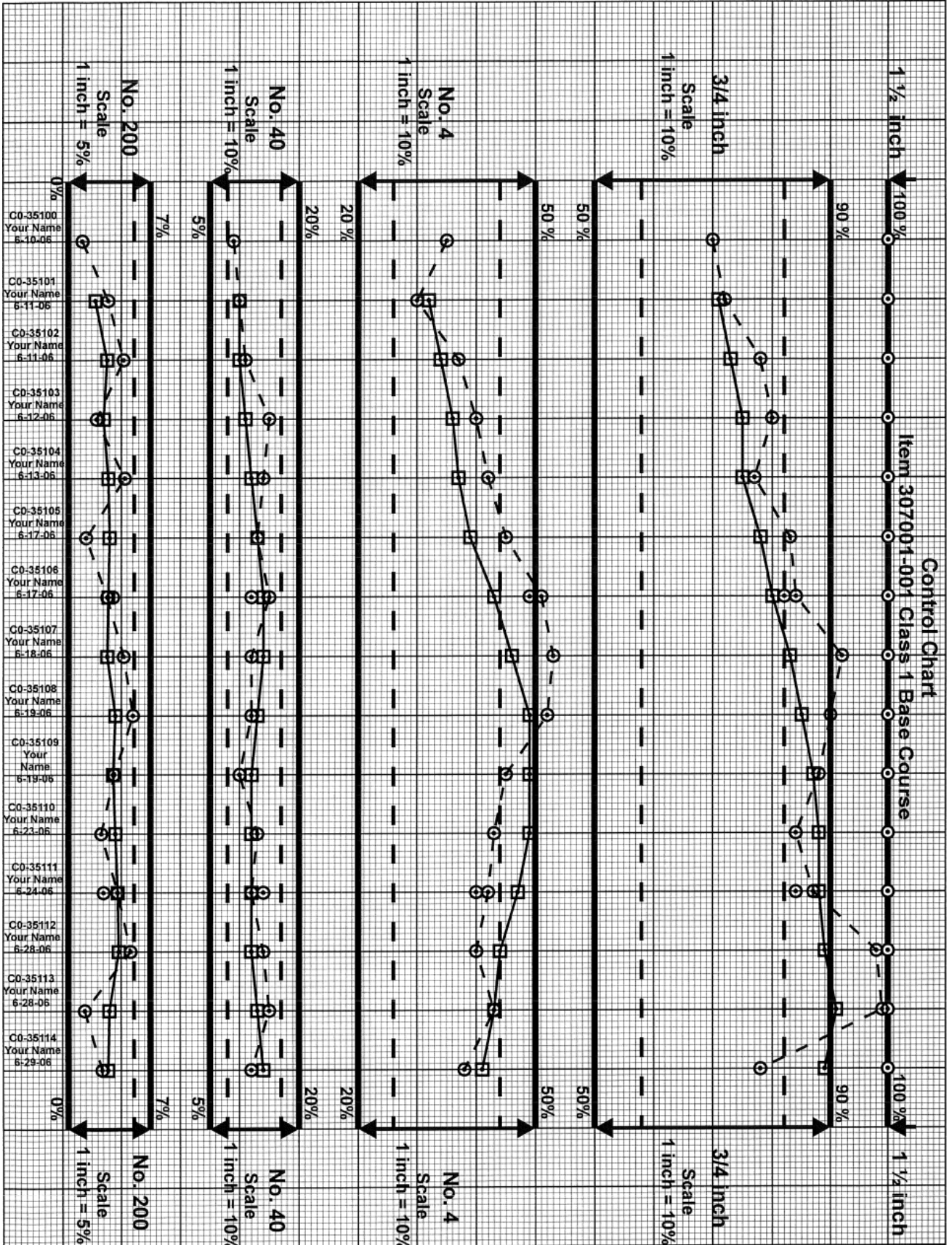

ACTION REQUIRED AS A RESULT OF  
GRADATION TESTING OF CLASS 1 BASE COURSE (ITEM 307001-001)

LAB# & DATE:

ACTION:

C0-35100	No action
C0-35101	No action
C0-35102	No action
C0-35103	No action
C0-35104	No action
C0-35105	No action
C0-35106	C0-35106 has an individual result outside specification limits on the No. 4 (4.75 mm) sieve so the contractor and project engineer should be promptly notified.
C0-35107	C0-35107 has individual results on the 3/4 in. (19.0 mm) and No. 4 (4.75 mm) sieves outside the specification limits and the averages of five consecutive samples are in the caution zones. The Project Engineer and the contractor should be promptly advised, and the following notation shall be made in the plant diary: "Contractor advised that Class 1 Base Course (Item 307001-001) material is borderline".



- C0-35108 An individual result on the No. 4 (4.75 mm) sieve outside the specification limits. Since this is the third consecutive individual sublot outside the specifications for that sieve, the contractor shall immediately be advised that the material is non-conforming and he should take immediate steps to correct the problem. A price reduction would also be warranted for the sublot of material represented by this sample.
- C0-35109 Individual results are back within the specification limits, however moving averages are still in the caution zones and the Project Engineer and contractor should be kept so advised, with appropriate notations in the diary.
- C0-35110 Individual results are closer to being under control, however moving averages are still in the caution zones and the Project Engineer and contractor should be kept so advised, with appropriate notations in the diary.
- C0-35111 Individual results are close to being under control, however moving averages are still in the caution zones and the Project Engineer and contractor should be kept so advised, with appropriate notations in the diary.
- C0-35112 An individual result for the 3/4 in. (19.0 mm) sieve is outside specification limits and the moving average is still in the caution zone. The Project Engineer and contractor should be kept so advised, with appropriate notations in the diary.
- C0-35113 In sublot C0-35113, the moving average on the No. 4 (4.75 mm) is outside the specification limits. The contractor should be immediately advised that the material is non-conforming, and action will be required to correct the problem. Even though the moving average is outside the specification limits, a price reduction would not be calculated for this sublot.
- C0-35114 The individual results for C0-35114 indicate the problem has been corrected. The action required for correction should be carefully studied. If the production process has been significantly changed, we would want to start a new moving average.

**This completes the instruction part of your training. We hope you have gained sufficient knowledge from it to guide you toward becoming a competent aggregate technician. Keep this instruction manual for future reference. It will be very useful when preparing for your written and practical examinations.**

(Find the answers to the 7 questions on Page 8-21 and mark or highlight the answers for easy retrieval during the written part of the Aggregate Technician Exam.)

## **CHAPTER EIGHT STUDY QUESTIONS**

1. What aggregate characteristic is most likely to change without warning?
2. What are the two methods available to the aggregate technician to record and visualize the gradation results chronologically?
3. What are "caution zones"?
4. According to MP300.00.51, the moving average can be done on no more than \_\_\_ samples?
5. How are Division Acceptance Samples represented on a control chart?
6. Are the above samples part of your moving average calculations?
7. When three consecutive individual test values are outside the specification limits, what should the technician do next?



## APPENDIX

1.	INDEX	A- 1
2.	SPECIFICATION FOR TESTING AGGREGATE	A- 2
3.	TEST TO BE PERFORMED	A- 3
4.	CONVERSION DATA	A- 4
5.	QUALITY CONTROL PLAN	A-5 to A-6
6.	ML-25 Procedure for Monitoring the Activities Related to Sieve Analysis of Fine and Coarse Aggregate	A-7 to A-11
7.	MP 106.03.50 General Information Guide for Quality Assurance Testing	A-12 to A-31
8.	MP 300.00.51 Procedural Guidelines for Maintaining Control Charts for Aggregate Gradation	A-32 to A-36
9.	MP 307.00.50 Guide for Quality Control and Acceptance Plans for Base Course	A-37 to A-49
10.	MP 601.03.51 Standard Method for Determination of $\bar{A}$ of the Total Solids in Portland Cement Concrete	A-50 to A-54
11.	MP 700.00.06 Aggregate Sampling Procedures	A-55 to A-63
12.	MP 700.00.54 Procedure for Evaluating Quality Control Sample Test Results with Verification Sample Test Results	A-64 to A-72
13.	MP 703.00.21 Standard Method of Test for Percent Crushed Particles	A-73 to A-77
14.	T300 - Sieve Analysis of Aggregate Worksheet	A-78
15.	T302 - Face Fracture Worksheet	A-79
16.	T303 - Calibration of Unit Weight Measure Worksheet	A-80
17.	T304 - Unit Weight of Aggregate Worksheet	A-81
18.	T305 - Specific Gravity of Fine Aggregate Worksheet	A-82
19.	T306 - Specific Gravity of Coarse Aggregate Worksheet	A-83
20.	T307 - Liquid Limit, Plastic Limit, and Plasticity Index Worksheet	A-84
21.	T307 - Graph for Liquid Limit Determination	A-85
22.	T100 - Test Sample Data Form	A-86
23.	Table 703A, 2002 Construction Manual (For information only)	A-87 to A-89

Specifications for Testing Aggregate

<u>ASTM</u>	<u>AASHTO</u> <u>Test</u>	<u>Part</u>	<u>Materials</u> <u>Procedures</u>	<u>Test Name</u>
C123	T113	2	MP 702.01.20	*Lightweight Pieces in Aggregate
C566	T255	2		Moisture Content, Total of Aggregate by Drying
C702	R76	2		Reducing Samples of Aggregate to Testing Size
C29	T19	2		Unit Weight of Aggregate
C136	T27	2		Sieve or Screen Analysis of Fine and Coarse Aggregate
D75	T2	2	MP 700.00.06	Sampling Aggregates
C88	T104	2	MP 703.00.22	*Soundness of Aggregates by Use of Sodium Sulfate or Magnesium Sulfate
C127	T85	2		Specific Gravity and Absorption of Coarse Aggregate
C128	T84	2		Specific Gravity and Absorption of Fine Aggregate
C117	T11	2		Test for Materials Finer than No. 200 (75 µm) Sieve in Mineral Aggregates by Washing
D448	M43	1		Standard Sizes of Coarse Aggregates for Highway Construction
C142	T112	2	MP 703.01.20	*Test for Clay Lumps and Friable Particles in Aggregate
C131	T96	2		*Resistance to Abrasion of Small Size Coarse Aggregate by use of the Los Angeles Machine

\* Not required to know in detail

## Tests To Be Performed

Tests to be performed for completion of the Aggregate Technician Certification Program practical examination are as follows:

1. Amount of Material Finer than the No. 200 (0.075 mm)  
Sieve in Aggregate  
AASHTO T-11
2. Gradation Analysis - coarse and fine  
AASHTO T-27
3. Specific Gravity and Absorption of Fine Aggregate  
AASHTO T-84
4. Specific Gravity and Absorption of Coarse Aggregate  
AASHTO T-85
5. Unit Weight of Aggregate  
AASHTO T-19
6. Determining the Liquid Limit of Soils  
Three Point Method  
AASHTO T-89
7. Determining the Plastic Limit and Plasticity  
Index of Soils  
AASHTO T-90
8. Standard Method of Test for Percent Crushed Particles  
West Virginia Division of Highways Procedures  
MP 703.00.21

As stated in the West Virginia Department of Transportation Standard Specifications Book, Section 106.3, AASHTO test methods are preferred, therefore all written and practical testing will be done in accordance with these methods. If ASTM methods are compatible with AASHTO methods, they may also be used.

## CONVERSION DATA

$$\text{Pounds} \times 0.4536 = \text{Kilograms}$$

$$\text{Pounds} \div 2.205 = \text{Kilograms}$$

$$\text{Kilograms} \div 0.4536 = \text{Pounds}$$

$$\text{Kilograms} \times 2.205 = \text{Pounds}$$

$$\text{Pounds} \times 453.6 = \text{Grams}$$

$$\text{Pounds} \div 0.002205 = \text{Grams}$$

$$\text{Grams} \div 453.6 = \text{Pounds}$$

$$\text{Grams} \times 0.002205 = \text{Pounds}$$

$$\text{Grams} \times 0.001 = \text{Kilograms}$$

$$\text{Grams} \div 1000.0 = \text{Kilograms}$$

$$\text{Kilograms} \times 1000.0 = \text{Grams}$$

$$\text{Kilograms} \div 0.001 = \text{Grams}$$

$$^{\circ}\text{F} = (9/5) ^{\circ}\text{C} + 32$$

$$^{\circ}\text{C} = 5/9 (^{\circ}\text{F} - 32)$$



EXAMPLE GUIDE FOR QUALITY CONTROL  
PLAN FOR ACCEPTANCE

Mr./ \_\_\_\_\_  
West Virginia Division of Highways  
District \_\_\_\_\_ Engineer  
\_\_\_\_\_  
\_\_\_\_\_, West Virginia

Dear Mr./ \_\_\_\_\_:

Base Course Aggregate  
Quality Control Plan  
Project \_\_\_\_\_

We are submitting our base course aggregate quality control plan developed in accordance with Section 307 of the \_\_\_\_\_ Standard Specifications, the \_\_\_\_\_ Special Provisions, and MP 307.00.50.

1. The quality control program is under the direction of \_\_\_\_\_ who can be contacted at telephone number \_\_\_\_\_.
2. Sampling and testing will be performed by \_\_\_\_\_, certified aggregate technician number \_\_\_\_\_, compaction testing will be performed by \_\_\_\_\_, certified compaction technician number \_\_\_\_\_.
3. The items to be incorporated controlled, and tests to be conducted are \_\_\_\_\_.
4. During the production and placement operation of the base course aggregate, our responsible people will perform the following quality control tests in accordance with \_\_\_\_\_ Standard Specifications and MP 307.00.50. (See Attachment #1 for Breakdown of Activities.)
5. All testing, evaluation and documentation will be completed within 72 consecutive hours from the time of sampling or production will be halted until all work is current.
6. Material found to be non-complying shall not be incorporated into the roadway. In the event that nonspecification material is incorporated into the project, the Division of Highways Project Engineer and District Materials Supervisor will be notified immediately. Disposition of failing material shall be in accordance with directives from the Division of Highways.
7. We will notify all appropriate Division of Highways personnel at least 24 hours before scheduled work is to begin.

Very truly yours,

\_\_\_\_\_

**Attachment #1**

<u>TEST OR ACTION</u>	<u>FREQUENCY</u>	<u>METHOD DOCUMENTATION</u>	<u>METHOD OF</u>
Samples from Roadway	One (1) per each half day of operation	MP 700.00.06	Daily log
Sieve Analysis	One (1) per each half day of operation (Small quantity exception see Note 1 in MP 307.00.50)	AASHTO T-11 AASHTO T-27	T300, Plant Control Charts
(Completed gradation samples will be retained in sealed bags with plastic liners at _____ laboratory until notified by the Division of Highways to dispose of them.)			
Atterberg Limits	One (1) test before start of operations and every 10,000 tons thereafter	AASHTO T-89 AASHTO T-90	WVDOH Form T307
Face Fracture	One (1) test before start of operations and every 10,000 tons thereafter	MP 703.00.21	WVDOH Form T302
Unit Weight (Slag only)	One (1) test before start of operations and every 10,000 tons thereafter	AASHTO T-19	WVDOH Form T304
Control Charts (The charts will be maintained by our _____ laboratory, until project completion. They will then be given to the Division of Highways.)	Results plotted at same frequency as sieve analysis	MP 300.00.51 Section 307 of Standard Specifications	As instructed in MP 300.00.51
Compaction Test	Five (5) density test per lot of 2000 LF	MP 700.00.24 MP 717.04.21 Section 717 of the Standard Specifications and _____ special provisions	T313 and T317 See separate quality control plan for compaction
Surface Tolerance		Section 307.6.1, 308.3.3 Diary Standard Specifications	
Thickness Tolerance		Section 307.6.2 Diary Standard Specifications	

WEST VIRGINIA DEPARTMENT OF TRANSPORTATION  
DIVISION OF HIGHWAYS  
MATERIALS CONTROL, SOILS AND TESTING DIVISION  
  
MATERIALS PROCEDURE

---

PROCEDURE FOR MONITORING THE ACTIVITIES RELATED TO SIEVE  
ANALYSIS OF FINE AND COARSE AGGREGATE

---

1.0 PURPOSE

- 1.1 To provide for management a means for checking the adequacy of equipment, procedures and testing techniques employed in the conduct of Sieve Analysis of Fine and Coarse Aggregate. For further emphasis, it is restated that this procedure is designed solely to provide a method for monitoring activities relative to sieve analysis and shall not be used in a manner that would revise or modify acceptance testing procedures for aggregate as set forth in other procedures and instructions.

2.0 SCOPE

- 2.1 This procedure shall be applied to the extent that all activities related to the sieve analysis of fine and coarse aggregate which are regularly conducted outside the District Central Laboratory shall be monitored. These activities are frequently performed at project sites, portland cement concrete batch plants and central mix plants, bituminous concrete plants and district sublabs.

3.0 PROCEDURE

- 3.1 All aggregate samples which have been tested for sieve analysis at locations other than the District Central Laboratory shall be retained until further disposition is determined by the District Materials Engineer/Supervisor. Care shall be taken to prevent loss of material when placing the weighed portions of the original sample into a clean, leak proof bag. If the original sample bag is used for this purpose, it should be leak proof and

clean. Each sample shall be positively identified with a District Laboratory Number or a field sample number or both, whichever is available, and other information as necessary for complete identification. The gradation work sheet should completely identify the sample and a copy of this document placed in the sample bag would be quite adequate.

- 3.2 Approximately once each week, the District Materials Engineer/Supervisor or his authorized representative shall visit each location at which sieve analyses of fine and coarse aggregates have been conducted, and he shall select from the total LOT of samples which have been tested and accumulated since his last visit at least one sample to be tested in the District Central Laboratory. It is most important that the sample selection be made by the District Materials Engineer/Supervisor or his authorized representative in as random a manner as possible and without influences that would tend to give particular samples a greater chance of being selected. To aid in accomplishing the foregoing, all aggregate samples from which the selection is to be made should be prominently displayed, and a frequent check should be made to ascertain that the collection of displayed samples is complete.
- 3.3 Each aggregate sample shall be tested in the District Central Laboratory using the sieves and test procedures set out in the governing specification for the item represented by the sample.

The following statement shall be written on the work sheets:

"MONITOR" test made to check lab. no. \_\_\_\_\_ where the District Laboratory Number for the original test is written in the blank space. Obtain a copy of the original gradation test report and keep it with the MONITOR test work sheets. No formal reporting of the MONITOR test work sheets. No formal reporting of the MONITOR test data need be done. Testing should be done at the earliest practical time in order to expedite the evaluation.

NOTE: If the MONITOR sample has previously been washed in conformance with the AASHTO T-11 test procedure, then this procedure need not be employed in the District Central Laboratory. Accordingly, the quantity lost in the initial application of the AASHTO T-11 shall be considered the total minus #200 sought and this quantity shall be added to the weight of the MONITOR sample prior to making test computations.

- 3.4 The MONITOR test data shall be compared with the original test data in the following manner:
  - 3.4.1 Determine the differences in test values for each of the specification sieves by subtracting the smaller test value from the larger test value.
  - 3.4.2 Obtain the sum of the differences in test values.
  - 3.4.3 Determine the average difference in test values by dividing the sum of the differences as described in 3.4.2 above by a whole number corresponding to the number of sieves used in the gradation test. The value thus obtained will be called the AVERAGE TEST DIFFERENCE (ATD).
- 3.5 The following guide shall be used as an aid in evaluating the ATD and determining appropriate actions to be taken.
  - 3.5.1 If the value of the ATD is equal to or less than 2.5 ( $ATD \leq 2.5$ ), the comparison would probably be considered favorable and no further investigation would be made. As a consequence, the testing technician should be instructed to discard the LOT of samples from which the MONITOR sample was selected.
  - 3.5.2 If the value of the ATD is greater than 2.5 but equal to or less than 4 ( $2.5 < ATD \leq 4$ ), the comparison would probably be considered questionable and approximately one third of the remaining samples in the LOT from which the MONITOR sample was selected should be tested and they should each comply with the requirement set out in 3.5.1 above. If each of the latter tests does comply, then the action set out in 3.5.1 should be taken. If each of the latter tests does not comply, then all remaining samples should be tested and the action set out in 3.5.3 below should be taken.

- 3.5.3 If the value of the ATD is greater than 4 ( $ATD > 4$ ), all remaining samples in the LOT from which the MONITOR sample was selected should be tested. A sufficiently thorough investigation should be made by the District Materials Engineer/Supervisor to allow him to make a judgement regarding the cause for the unfavorable test comparison. The results of this investigation and all pertinent test data will be reported in a District Materials Inspection Report (DMIR). The investigation and reporting shall be accomplished at the earliest practicable time so that the situation may be most expeditiously resolved. The Materials Control, Soils and Testing Division should be consulted when the action set out in this article is to be taken.
- 3.6 At the end of each fourth evaluation period, approximately four weeks, the District Materials Engineer/Supervisor shall prepare a report entitled "Implementation of Procedures for Monitoring Activities Related to the Sieve Analysis of Fine and Coarse Aggregate". The report will generally consist of a single page on which six columns of information or data is recorded as follows:
- 3.6.1 Column 1 shall be headed "Test Location". Give job location, or plant or sublab location where tests were conducted.
- 3.6.2 Column 2 shall be headed "Date of last Monitor Sample Selection".
- 3.6.3 Column 3 shall be headed "Date of this Monitor Sample Selection".
- 3.6.4 Column 4 shall be headed "Number of Samples in LOT". Give the number of samples in LOT from which the Monitor sample was selected.
- 3.6.5 Column 5 shall be headed "Standard Aggregate Size". Give item number for base course materials.
- 3.6.6 Column 6 shall be headed "Average Test Difference". Report value of ATD to nearest 0.1. The reports shall be identified as having been issued in accordance with this memorandum, ML-25.

3.7 The reports described in article 3.5.3 and subsection 3.6 shall be distributed as follows:

3.7.1 District Materials Inspection Report:

- 1 copy to District Materials File
- 1 copy to MCS&T Division
- 1 copy to Construction Division
- 1 copy to District Engineer, if requested

3.7.2 Four-Week Reports:

- 1 copy to District Materials File
- 1 copy to MCS&T Division
- 1 copy to Construction Division
- 1 copy to District Engineer

---



Gary L. Robson, Director  
Materials Control, Soils  
and Testing Division

GLR:k

WEST VIRGINIA DEPARTMENT OF TRANSPORTATION  
DIVISION OF HIGHWAYS  
MATERIALS CONTROL, SOILS AND TESTING DIVISION

---

GENERAL INFORMATION GUIDE FOR TECHNICIAN AND INSPECTOR  
CERTIFICATION PROGRAM (TICP)

---

**1. PURPOSE**

- 1.1 The purpose of the West Virginia Division of Highways (WVDOH) Technician and Inspector Certification Program is to improve the quality assurance of embankments, subgrades, base course, asphalt and Portland cement concrete by the certification of industry and WVDOH. This procedure is to establish guidelines for this purpose.
- 

**2. GENERAL**

- 2.1 It is the WVDOH's intent to conduct a cooperative program of training, study, and examination so that personnel of the producer, contractor, and the WVDOH will be able to better assure, by their increased technical knowledge, the level of quality required by the governing Specifications.
- 

**3. SCOPE**

- 3.1 This procedure is applicable to all requirements, guidelines, and other support documents of the WVDOH that reference conditions, methods, and levels of qualification specific to the WVDOH Training and Certification Program.
- 

**4. POLICIES AND ADMINISTRATION**

- 4.1 Board of Certification - The Certification Program will be carried out in accordance with general policy guidelines established or approved by the Chief Engineer . They will be advised by a Board composed of the following members:

1. Chief Engineer
2. Human Resources Director
3. Materials Control Soils and Testing (MCS&T)'s Director
4. Quality Assurance Training Program Administrator
5. Applicable MCS&T Supervisors

- 4.1.1 The Certification Board will meet upon call of the MCS&T's Director.

- 4.2 Administration - The program will be administered by the Director of the MCS&T (hereafter referred to as "Director"). The Director will have the assistance of an Implementation Committee appointed by the Chief Engineer as follows:



1. Quality Assurance Training Program Administrator
  2. Applicable MCS&T Supervisors
  3. A representative of the WVDOH Human Resources Division.
- 4.2.1 In addition the Certification Board may jointly select representatives of producers and contractors to work with the Implementation Committee at such times and on such matters as the Director and the representatives mutually agree. These representatives shall not be candidates for certification.
- 4.2.2 The Implementation Committee will meet upon call of the Director, or person authorized by the Director. The board shall have a minimum of three (3) members in order to form a quorum for a meeting.
- 4.2.3 The Program Administrator shall be appointed by the Director. The Program Administrator will be assigned to assist the Director in administering the program and to handle planning, administration, and coordinating functions as may be delegated within the scope of appropriate WVDOH directives.

---

**5. REQUIREMENTS**

- 5.1 Where applicable, quality control representatives of a contractor or producer will be certified in one (or more) of the certifications listed in Section 6.0, depending upon the individual's duties or responsibilities. Responsibilities and qualification requirements are listed in appropriate support documents such as Materials Procedures, Quality Control Plans and others.
- 5.2 For purposes of the WVDOH Quality Assurance Program, a non- WVDOH certified technician/Inspector represents the company of which he/she is a full-time employee on the WVDOH project, owner, or partner (as defined by the Federal Wage and Hour Legislation). If said company has subsidiary or affiliated organizations, each organization will be required to have its own certified Technicians/Inspectors where applicable unless the Chief Engineer makes an exception. Exceptions will be granted only when it can be proven that the certified Technician/Inspector actually performs the duties of the technician/inspector for all of the subsidiary or affiliated organizations.
- 5.3 Designated WVDOH personnel will be certified where applicable in one (or more) of the certifications listed in Section 6.0 depending upon the individual's duties and responsibilities.

---

## 6. CERTIFICATIONS

6.1 All certifications listed in the sections below require written examinations. Some of the listed certifications require a practical examination after successful completion of the written examination. It is the responsibility of the applicant to determine which certification is applicable to his/her assignment. Following is a description of the certifications listing relevant information about each:

### 6.2 AGGREGATE CERTIFICATIONS

6.2.1 Aggregate Sampling Inspector - The web-based examination for an Aggregate Sampling Inspector consists of the following areas:

1. Specifications
2. Sampling Fundamentals
3. Sampling Methods and Equipment
4. Gradations
5. T11 Wash Test

6.3 The Aggregate Sampling Inspector requires the successful completion of an online examination. Certification as an Aggregate Sampling Inspector qualifies the employee, either Industry or Division, to perform sampling of aggregates relevant to the Quality Control Program or Acceptance Program respectively.

6.3.1 Aggregate Technician - The written examination for an Aggregate Inspector consists of the following areas:

1. Aggregate Specifications and Procedures
2. Aggregate Fundamentals
3. Sampling, Control, and Inspection of Aggregates
4. Aggregate Testing

6.3.2 After successful completion of the written examination, the applicant will be required to pass a practical examination consisting of his/her demonstration of testing common to normal aggregate quality requirements. Certification as an Aggregate Inspector qualifies the employee, either Industry or Division, to perform sampling and/or testing of aggregates relevant to the Quality Control Program or Acceptance Program respectively.

## 6.4 COMPACTION CERTIFICATIONS

6.4.1 Soils and Aggregate Compaction Inspector - The written examination for a Soils and Aggregate Compaction Inspector consists of the following areas:

1. Specifications
2. Soil Compaction Test Procedures
3. Radiation Safety and Nuclear Gauge
4. Test Procedure Problems

6.4.2 After successful completion of the written examination, the applicant will be required to pass a practical examination demonstrating his/her proficiency in using the testing equipment. Certification of the Soils and Aggregate Compaction Inspector qualifies the employee, either Industry or Division, to conduct tests on all Soil and Aggregate construction materials that require compaction testing.

## 6.5 CONCRETE CERTIFICATIONS

6.5.1 Concrete Technician - The written examination for a Concrete Technician consists of the following areas:

1. Specifications
2. Fundamentals
3. Sampling and Testing
4. Control and Inspection
5. Mix Proportioning and Adjustment

6.5.2 The Concrete Technician requires only the successful completion of the written examination; no practical examination test is required. Certification of the Concrete Technician qualifies the employee, either Industry or Division, to make plant and mix adjustments, proportioning, and other duties.

6.5.3 Concrete Inspector - The written examination for a Concrete Inspector consists of the following areas:

1. Fundamentals
2. Sampling and Testing
3. Control and Inspection
4. Specifications

6.5.4 After successful completion of the written examination, the applicant will be required to pass a practical examination demonstrating his/her proficiency in conducting tests common to concrete quality control. Certification as a Concrete Inspector qualifies the employee, either Industry or Division, to perform sampling and/or testing of concrete relevant to the Quality Control Program or Acceptance Program respectively.

## 6.6 ASPHALT MIXTURE CERTIFICATIONS

6.6.1 Asphalt Plant Technician - The written examination for an Asphalt Plant Technician consists of the following areas:

1. Specifications
2. Fundamentals
3. Sampling and Testing
4. Control and Inspection
5. Mix Proportioning and Adjustment

6.6.2 After successful completion of the written examination, the applicant will be required to pass a practical examination demonstrating their proficiency in conducting tests common to Asphalt quality control. Certification of the Asphalt Technician qualifies the employee, either Industry or Division, to take asphalt mixture samples, perform quality control or quality assurance testing on plant produced asphalt mixtures, make plant and mix adjustments, aggregate proportioning, and other duties.

6.6.3 Asphalt Field Technician – The written examination for an Asphalt Field Technician consists of the following areas:

1. Specifications
2. Surface Preparation
3. Mix Delivery and Placement
4. Joint Construction
5. PWL
6. Asphalt Compaction

6.6.4 Successful completion of the written examination and a practical examination test is required. Certification as an Asphalt Field Technician qualifies the employee, either Industry or Division, to oversee or inspect asphalt pavement construction. In addition, the class hand-out material is a valuable reference tool for each stage of the construction process. The required radiation safety training is included in this class and will certify attendees with a passing score to perform nuclear density testing on asphalt pavements.

6.6.4.1 Asphalt Field Technicians must also be evaluated by qualified District personnel on the first WVDOH paving project in which they perform this testing. The District personnel will make the decision as to whether or not the technician is correctly conducting the nuclear density tests in accordance with the Specifications. The District will also complete an evaluation form and send it to the MCS&T for processing. A technician that does not demonstrate proper nuclear density testing techniques shall not be allowed to continue testing on the WVDOH project. They must be replaced by another qualified technician. Anyone who does not meet the evaluation standards must provide proof of additional WVDOH approved radiation safety training before another evaluation will be conducted.

6.6.5 Inertial Profiler Operator- The written examination for the inertial profiler operator covers of the following areas:

1. WVDOH Specifications
2. AASHTO and ASTM Specifications
3. Knowledge of operation and analysis of collected data.

6.6.6 This certification covers an employee of either a contractor, consultant, or DOH staff to operate a lightweight/low-speed and high-speed inertial profiler.

6.7 Radiation Safety

6.7.1 This certification is required by the Nuclear Regulatory Commission (NRC) before operating a portable nuclear gauge. The training consists of 3 - 4 hours classroom instruction and has a 25-50 question closed book exam. A minimum score of 70 percent is required for passing the course. The course and exam will cover the following areas:

1. Proper storage and security of portable nuclear gauges
2. Transportation of portable nuclear gauges
3. Personal safety while operating a portable nuclear gauge.

---

## 7. TRAINING

7.1 Training - The Division of Highways, contractors, and producers may sponsor courses of instruction consisting of schools and seminars to help prepare personnel for certification under one or more of these certification programs. To the extent possible, these courses of instruction will be joint efforts of the industry and WVDOH. Nothing in this document shall be interpreted to prohibit any party from conducting courses of instruction for their personnel to assist in preparation for these exams.

7.2 The purpose of the schools is to provide helpful information and instruction for people preparing to take the WVDOH Technician/Inspector examinations. These courses are designed to provide instruction for people with a basic foundation in the subject matter.

---

## 8. EXAMINATIONS

8.1 Examinations, both written and practical, will be coordinated by MCS&T. The locations and dates of the examinations will be announced on the [MCS&T's Webpage](http://transportation.wv.gov/highways/mcst/Pages/techcert.aspx)<sup>1</sup>. The examinations may be held on a regional basis when feasible. Most written examinations will be an "open book" type, with a time limit. Practical examinations require performance of the tests required by the Specifications for the material type involved.

---

<sup>1</sup> <http://transportation.wv.gov/highways/mcst/Pages/techcert.aspx>

- 8.2 To pass the written examinations, the applicant must obtain a score of at least 70 percent. The Inertial Profiler Operator exam requires a minimum of 75 percent to pass. The applicant will be allowed two attempts within a 12-month period to obtain a passing score per each certification class attended.
- 8.3 After the applicant passes the written examination, the applicant will have two attempts within a 12-month period to pass the practical exam. (Where applicable)
- 8.4 Certificate Non-Transferable - The status of the certification for a Technician or an Inspector is not transferable and is valid only for the quality control procedures designated by the bearer's certificate.
- 8.5 Revocation of Certificate - If at any time a WVDOH, contractor's, producer's, or supplier's Technician or Inspector is found to have altered or falsified test reports or is found to have improperly performed tests or reported their results, the individual's certification may be rendered invalid by the Chief Engineer upon recommendation of the Implementation Committee and/or the Board.
- 8.6 Renewal and Certification – Certifications shall be renewed as required in the Technician Inspector Certification Program (TICP) handbook. General guidance and information for renewal will be recommended by the Board as required by the Chief Engineer. All certifications shall terminate on December 31st of the year of expiration. There may be written, and practical examination required for recertification where applicable. More recertification information can be found in the Technician Inspector Certification Program (TICP) handbook available on the [MCS&T's Webpage](#)<sup>2</sup>.
- 8.6.1 The responsibility for obtaining re-certification shall lie with the certified individual.
- 8.6.2 The Implementation Committee or other designated party shall establish internal criteria for renewal. The Technician Certification Handbook with the current rules and requirements shall be posted on the [MCS&T's Webpage](#).
- 8.6.3 Upon obtaining renewal of certification, a renewal card may be printed from the [MCS&T Webpage](#).
- 8.7 For further information on classes, recertification, schedules, class calendars and other helpful information please visit the [MCS&T's Webpage](#).

---

## 9. FUNCTIONS AND RESPONSIBILITIES

- 9.1 Contractor or Producer - The producer and contractor will be responsible for product control of all materials during the handling, blending, and mixing operations. The

---

<sup>2</sup> <http://transportation.wv.gov/highways/mcst/Pages/techcert.aspx>

contractor and producer also will be responsible for the formulation of a design mix that will be submitted to the Division for approval.

- 9.1.1 Technician/Inspector - A Quality Control representative of a contractor or producer should be a certified Technician/Inspector as outlined in Section 5. and whose responsibilities may include such duties as proportioning and adjusting the mix, sampling and testing the product, and preparing control charts.
- 9.2 The WVDOH - The WVDOH is responsible for all acceptance decisions.
  - 9.2.1 District Materials Supervisor - District Materials activities are the responsibility of the District Materials Supervisor.
  - 9.2.2 Division Technicians and Inspectors – The WVDOH Technicians and Inspectors will be assigned as necessary to carry out the required acceptance decision activities. The WVDOH representatives will not issue instructions to the contractor or producer regarding process control activities. However, the WVDOH representatives have the responsibility to question, and where necessary to reject, any operation or sequence of operations, which are not performed in accordance with the contract documents.



02/29/2024

---

Ronald L. Stanevich, PE  
Director  
Materials Control, Soils & Testing Division

MP 106.03.50 Steward – Personnel, Payroll Section  
RLS:Eh  
ATTACHMENT



# WEST VIRGINIA TECHNICIAN INSPECTOR CERTIFICATION PROGRAM HANDBOOK



Revised FEBRUARY 29, 2024



---

**1. INTRODUCTION**

- 1.1 The purpose of the West Virginia Division of Highways (WVDOH) Technician and Inspector Certification Program (TCIP) is to improve the quality assurance of embankments, subgrades, base course, asphalt and Portland cement concrete by the certification of industry and Division of Highways personnel. This document is to establish guidelines for this purpose.
- 1.2 The Division's intent is to conduct a cooperative program of training, study, and examination so that personnel of the producer, contractor, and the Division of Highways will be able to better assure, by their increased technical knowledge, the level of quality required by the governing Specifications.
- 1.3 This document, along with MP 106.03.50, is applicable to all requirements, guidelines, and other support documents of the Division of Highways that reference conditions, methods, and levels of qualification specific to the Division of Highways' training and certification program.
- 1.4 There are often changes and additions to the TICP, so please, thoroughly review this document as well as the MCS&T Webpage to find out about any applicable changes.

---

**2. CERTIFICATION BOARD**

- 2.1 As per MP 106.03.50 the certification board members are:
1. Chief Engineer
  2. Human Resources Director
  3. Materials Control Soils & Testing Director
  4. Quality Assurance Training Program Administrator
  5. Applicable Materials Control Soils and Testing Group Supervisors

---

**3. APPLICATION AND CLASS SIGN-UP INSTRUCTIONS**

- 3.1 For course registration, instructions, please visit the [WVDOH MCST Webpage](#)<sup>1</sup> for Instructions:

---

**4. CERTIFICATIONS**

- 4.1 The TICP offers certification classes in the following disciplines:
1. Aggregate Technician
  2. Aggregate Sampling Inspector
  3. Soils & Aggregate Compaction Technician
  4. Portland Cement Concrete Technician
  5. Portland Cement Concrete Inspector
  6. Asphalt Plant Technician
  7. Asphalt Field & Compaction Technician
  8. Radiation safety

**\*\*EXCEPT AS NOTED HEREIN ALL CERTIFICATIONS ARE VALID FOR A THREE-YEAR PERIOD\*\***

---

**5. CLASS SUPPLY LIST**

- 5.1 We recommend that participants bring the following items with them to the certification classes:
1. Laptop Computer or Tablet (Mandatory)
  2. Photo ID
  3. Current WV Specification book and the latest Supplemental to the Specification book. You will need this during the test. These are also available in printable PDF format on the [WVDOH Webpage](#).<sup>2</sup>
  4. Hand held calculator (No electronic devices other than a Hand held calculators are allowed to be used during testing.)
  5. Hi-lighters
  6. Sticky Notes
  7. Ruler / Straight edge

---

<sup>1</sup> <https://transportation.wv.gov/highways/mcst/Pages/techcert.aspx>

<sup>2</sup> <https://transportation.wv.gov/highways/contractadmin/specifications/Pages/default.aspx>

---

**6. SPECIAL NEEDS AND REQUESTS**

- 6.1 Applicants with special needs should notify the Quality Assurance Training Program Administrator prior to the class to ensure that the training location is prepared to accommodate their needs.

---

**7. RECIPROCAL CERTIFICATIONS**

- 7.1 The West Virginia Division of Highways may recognize reciprocity certifications from other states. See MP 106.03.51 for detailed instructions.
- 7.2 American Concrete Institute (ACI) Field Testing Grade I certification will be accepted as a portion of the West Virginia PCC Inspector training. However, the applicant must pass the online West Virginia PCC Inspector written certification test before a certification will be issued.
- 7.3 Acceptance of WVDOH Certifications by other state agencies is at the sole discretion of the other agency.

---

**8. TRAINING**

- 8.1 The Division of Highways, contractors, and producers may sponsor courses of instruction consisting of schools and seminars to help prepare personnel for certification under one or more of these certification programs. To the extent possible, these courses of instruction will be joint efforts of the industry and WVDOH. Nothing in this document shall be interpreted to prohibit any party from conducting courses of instruction for their personnel to assist in preparation for these exams.
- 8.2 The purpose of the schools is to provide helpful information and instruction for people preparing to take the technician/inspector examinations. These courses are designed to provide instruction for people with a basic foundation in the subject matter.

---

**9. CERTIFICATIONS**

- 9.1 All certifications listed in the sections below require written examinations. Some of the listed certifications require a practical examination after successful completion of the written examination. Applicants are responsible to determine which certification is applicable to their assignment. The

following is a description of the certifications listing relevant information about each:

---

**10. AGGREGATE CERTIFICATIONS**

10.1 Aggregate Sampling Inspector

10.1.1 The written examination for an Aggregate Sampling Inspector consists of the following areas:

1. Specifications
2. Sampling Fundamentals
3. Sampling Methods and Equipment
4. Gradations
5. T11 Wash Test

10.2 There is no in-person class for the Aggregate Sampling Inspector Certification; the class is online-only and on-demand. The Aggregate Sampling Inspector Certification requires the successful completion of the examination. Certification as an Aggregate Sampling Inspector qualifies the employee, either industry or Division, to perform sampling of aggregates relevant to the quality control program or acceptance program respectively.

10.3 The test will be available online throughout the year but may only be attempted twice per year. A score of 70 is required for passing Aggregate Sampling Inspector.

10.4 Aggregate Technician

10.4.1 The written examination for an Aggregate Technician consists of the following areas:

1. Specifications
2. Aggregate Specifications and Procedures
3. Aggregate Fundamentals
4. Sampling, Control, and Inspection of Aggregates
5. Aggregate Testing

10.5 After successful completion of the written examination, applicants will be required to pass a practical examination consisting of their demonstration of procedures common to normal aggregate quality requirements. Certification as an Aggregate Technician qualifies the employee, either industry or

Division, to perform sampling and/or testing of aggregates relevant to the quality control program or acceptance program respectively.

---

**11. COMPACTION CERTIFICATIONS**

- 11.1 Soils & Aggregate Compaction Technician (SACT) - The written examination for the Soils & Aggregate Compaction Technician consists of the following areas:
1. Specifications
  2. Compaction Test Procedures
  3. Radiation Safety and Nuclear Gauge
  4. Test Procedure Problems
- 11.2 After successful completion of the written examination, the applicant will be required to pass a practical examination demonstrating his/her proficiency in using the testing equipment. Certification of the Compaction Technician qualifies the employee, either industry or Division, to conduct tests on all soil construction materials that require compaction testing.
- 

**12. CONCRETE CERTIFICATIONS**

- 12.1 Portland Cement Concrete Technician
- 12.1.1 The written examination for a Portland Cement Concrete Technician consists of the following areas:
1. Specifications
  2. Fundamentals
  3. Sampling and Testing
  4. Control and Inspection
  5. Mix Proportioning and Adjustment
- 12.2 The Portland Cement Concrete Technician certification requires only the successful completion of the written examination; no practical examination is required. Certification of the Portland Cement Concrete Technician qualifies the employee, either industry or Division, to make plant and mix adjustments, proportioning, and other duties.

- 12.3 Portland Cement Concrete Inspector
- 12.3.1 The written examination for a Portland Cement Concrete Inspector consists of the following areas:
1. Specifications
  2. Fundamentals
  3. Sampling and Testing
  4. Control and Inspection
  5. Specifications
- 12.4 After successful completion of the written examination, applicants will be required to pass a practical examination demonstrating their proficiency in conducting tests common to concrete quality control. Certification as a Portland Cement Concrete Inspector qualifies the employee, either industry or Division, to perform sampling and/or testing of concrete relevant to the quality control program or acceptance program respectively.

---

**13. ASPHALT CERTIFICATIONS**

- 13.1 Asphalt Plant Technician
- 13.1.1 The written examination for the Asphalt Plant Technician consists of the following areas:
1. Specifications
  2. Fundamentals
  3. Sampling and Testing
  4. Control and Inspection
  5. Mix Proportioning and Adjustment
- 13.2 After successful completion of the written examination, applicants will be required to pass a practical examination demonstrating their proficiency in conducting tests common to Asphalt quality control. Certification of the Asphalt Technician qualifies the employee, either industry or Division, to take asphalt mixture samples, perform quality control or quality assurance

testing on plant produced asphalt mixtures, make plant and mix adjustments, aggregate proportioning, and other duties.

- 13.3 Asphalt Field and Compaction Technician (AFCT) –
- 13.3.1 The written examination for the Asphalt Field and Compaction Technician consists of the following areas:
1. Specifications
  2. Compaction Test Procedures
  3. Radiation Safety and Nuclear Gauge
  4. Test Procedure Problems
  5. Testing Forms
- 13.4 After successful completion of the written examination, applicants will be required to pass a practical examination demonstrating their proficiency in using the testing equipment. Certification of the Asphalt Field & Compaction Technician qualifies the employee, either industry or Division, to conduct tests on all asphalt materials that require compaction testing.

---

**14. RADIATION SAFETY**

- 14.1 This certification is required by the Nuclear Regulatory Commission (NRC) before operating a portable nuclear gauge. The training consists of 3 - 4 hours classroom instruction and has a 25-50 question closed book exam. A minimum score of 70% is required for passing the course. The course and exam will cover the following areas:
1. Proper storage and security of portable nuclear gauges
  2. Transportation of portable nuclear gauges
  3. Personal safety while operating a portable nuclear gauge.

---

**15. EXAMINATIONS**

- 15.1 All participants are required to furnish their own laptop or tablet to take the final course exams. Examinations, both written and practical, will be coordinated by MCS&T. The locations and dates of the examinations will be announced at least two weeks prior to being given. All written examinations will be a one-part, 'open-book' type, with a time limit.
- 15.2 If an applicant fails to receive a minimum score of 70% on the first exam, they will be given another attempt to score a 70%. This second attempt shall

be a subsequent, scheduled make-up exam. Failure to attend any examination counts as a failed exam.

- 15.3 If the re-test examination is not passed, the applicant must attend the certification school. Practical examinations require performance of the tests required by the Specifications for the material type involved.
- 15.4 After the applicant passes the written examination, they will be granted two attempts within a 12-month period to pass the practical exam. All practical examinations are pass / fail. If an applicant fails the practical twice, the applicant may not take another practical test in the same 12-month period without first attending the certification school. The scheduling of the practical examination and re-examination is established by the MCS&T section running the certification class.

---

**16. CERTIFICATION AND RE-CERTIFICATION**

16.1 Certification

16.1.1 An individual must pass the examination in each level for which they are requesting certification. Unless otherwise noted, to pass the written examinations, the applicant must obtain a minimum score of 70 percent.

16.1.2 If an applicant fails to receive a minimum score of 70% on the first exam, they will be given another attempt at a later date to score a 70%. This second attempt shall be a subsequent, scheduled make-up exam. Failure to attend any examination counts as a failed exam.

16.1.3 Upon successfully completing the requirements for certification, applicants may print their certification card from the divisions Webpage. <http://dotftp.wv.gov/materialsdir/>

16.1.4 This certification is not transferable. A certification is valid for up to Three years and expires December 31, of the 3rd year of certification.

16.2 Re-Certification

16.2.1 The renewal of all certifications shall require a written exam and a hands-on practical exam, where applicable.

16.2.2 Applicants will be given two scheduled attempts to pass the recertification exam and one attempt to pass the practical exam (each, respectively). Any applicant that fails to acquire a minimum score of 70% on a recertification exam or who fails the subsequent practical exam will not have their certification renewed. The applicant will be required to take the respective certification classes at the next available time given by MCS&T.

16.2.3 Any failed recertification examination taken prior to the expiration date of the current certification, either practical or written will not result in



termination of any current certification prior to the expiration date of that certification.

- 16.2.4 The certification holder is responsible updating their personal information on the [online learning website](#)<sup>3</sup>.
- 16.2.5 Certification holders are responsible to ensure that their certifications stay current. The West Virginia Division of Highways will no longer mail reminder letters to certification holders.
- 16.2.6 If an applicant seeking recertification disagrees with a recertification decision, they may file a written appeal with the board. (See Appealing a Decision).

---

**17. TESTING PROTOCOL**

- 17.1 The TICP has a testing protocol that must be followed. The protocol includes testing environment, time limits, proctoring exams, etc. The entire protocol will be covered with attendees prior to testing.

---

**18. REVOCATION OF CERTIFICATION**

- 18.1 The Certification Board grants certification upon satisfactory completion and maintenance of certain conditions and may be revoked upon any breach of these conditions.
- 18.2 Generally, certifications may be revoked if in the opinion of the certifying authority, an individual has knowingly committed acts detrimental to the integrity of the Certification Program or transportation industry. Examples of situations that warrant revocation include, but are not limited to:
  - 1. Deliberate falsification of field or quality control test results or records.
  - 2. Deliberate falsification of calculations, test results or materials
  - 3. Cheating on certification/re-certification exams.
  - 4. Submittal of false information on certification applications.
  - 5. Submitting trial mix mixture and/or calculations completed by someone other than the signatory, or knowingly supplying trial mix mixture and/or calculations for another individual's certification.
- 18.3 The Quality Assurance Training Program Administrator will take the lead in gathering facts and investigating any allegations which may require

---

<sup>3</sup> <http://www.onlinelearning.wv.gov/student/home.html>

revocation of a certification. The review board will notify the individual in writing of intent to revoke certification(s).

---

**19. APPEALING A DECISION**

19.1 Any individual who disagrees with a decision by the Certification Board has 10 business days from the date of receipt of the notification to respond in writing to the board and present documentation to support their continued certification and/or request an opportunity for a meeting to present their case.

19.2 If the individual fails to respond within 10 days of receipt of the original notification of revocation letter, the revocation becomes final.

Not later than 20 business days after receiving a request for a meeting from the individual, the Certification Board will schedule a meeting in which the appellant can present their case. If the Certification Board was not persuaded by the documentation provided by the appellant and believes that revocation of the certification is warranted, the appellant may file a written appeal to the Chief Engineer for review. All information including any letter(s) of explanation from the appellant will accompany the documents submitted to the Chief Engineer. The board will mail the decision of the Chief Engineer to the appellant. The decision by the Chief Engineer is final.

---

**20. THE LENGTH OF REVOCATION:**

20.1 First Offense

20.1.1 This may include revocation of all certifications for up to one year. After the revocation period the individual may obtain recertification by passing respective certification exam and a practical (if applicable). If either exam is failed, the individual will be required to take the certification class before being permitted to test again. The individual will be required to retake and pass the written exam regardless of whether it was previously passed.

20.2 Second Offense

20.2.1 This may include revocation of all certifications for up to five years. There is also the possibility of demotion and reduced pay for WVD OH employees. After the revocation period the individual may obtain recertification by passing the respective certification exam and a practical (if applicable) at the discretion of the board. If either exam is failed, the individual will be required to take the certification class before being permitted to test again.

The individual will be required to retake and pass the written exam regardless of whether it was previously passed.

20.3 Third Offense

20.3.1 This may include revocation of all certifications for life. There is also the possibility of termination, demotion and reduced pay for WVDOH employees.

---

**21. CONTACT INFORMATION**

21.1 If an applicant/technician/appellant has any questions about the DOH program or needs more information. Please contact: [Qaschoolscoordinator@wv.gov](mailto:Qaschoolscoordinator@wv.gov)

WEST VIRGINIA DEPARTMENT OF TRANSPORTATION  
DIVISION OF HIGHWAYS  
MATERIALS CONTROL, SOILS AND TESTING DIVISION

MATERIALS PROCEDURE

---

PROCEDURAL GUIDELINES FOR MAINTAINING CONTROL  
CHARTS FOR AGGREGATE GRADATIONS

---

**1. PURPOSE**

- 1.1 To provide a standard method for developing and maintaining control charts to evaluate the grading characteristics of mineral aggregates.
- 

**2. SCOPE**

- 2.1 Control charts shall be maintained where specified for sized aggregates, for bases and sub-bases, aggregates for Portland Cement and asphalt mixtures, etc.
- 

**3. INTENT**

- 3.1 It is the intent to have the procedure outlined hereinafter used in instances in which it can be reasonably and logically applied. The applicability of the procedure shall normally depend on circumstances such as the number of samples, the continuity of delivery, etc. The moving average may not necessarily be continuous for the entire project. A new moving average series may be started after periods of inactivity, changes in materials or processes, change in job mix formula, resuming operations after correcting deficiencies, etc.
- 

**4. GENERAL**

4.1 Paper Charts

- 4.1.1 Control charts shall be prepared on 10 x 10 cross section paper approximately 25 inches wide. A chart length of approximately 30 inches shall be displayed at all times. When standard cross section sheets are used, the most recent sheet must be displayed, and all the previous sheets placed chronologically in a holder.

- 4.1.2 The item number and/or description of the material shall be noted on the top of the chart and visible at all times.

- 4.1.3 Control charts shall be maintained at the project office or at the testing site where applicable.

- 4.1.4 Scale – The control chart shall have a vertical scale of one division equal to one percentage point (or one inch equal to 10 percent), except in the following cases: (a) a vertical scale of two divisions equal to one percentage point (or one inch equals five percent) shall be used for any sieve which has a specification tolerance range less than ten percent, and (b) in the case of coarse aggregates used in

Portland cement concrete, a vertical scale of one division equal to 0.1 percentage point (or one inch equal to one percent) shall be used for the #200 sieve.

- 4.1.5 On the horizontal scale the test values shall be plotted on the heavy, vertical lines (one inch apart), progressing from the left to the right.
- 4.1.6 General Arrangement- Control charts are to be arranged on the cross-section paper in the manner described below; an example of the arrangement is shown on Attachment 1. [Note on the attachment the 10 X 10 squares are “stretched” vertically to allow the graph to fit the 8 1/2 by 11 paper.]
- 4.1.7 The largest sieve size shall be located toward the top of the chart and the smallest sieve size toward the bottom of the chart. The spacing between the lower limit of one sieve and the upper limit of the adjacent sieve shall be a minimum of one inch.
- 4.1.8 The vertical scale for each sieve shall be arranged so that the heavy lines shall have a value of zero or a value which is a multiple of five. For instance, zero, five, ten, fifteen, etc.
- 4.1.9 Lines corresponding to the upper and lower limits of the specification shall be drawn in red (pen or pencil) across the graph. At the beginning and end of each sheet (or length of the displayed portion) a vertical red line shall be drawn between the specification limits of each sieve, an arrow shall be placed at the end of each vertical line. The specification limits shall be indicated above and below the arrows, and the sieve size and scale shall be indicated between the limits on the outside of the displayed portion of the chart.
- 4.1.10 Inside the solid red lines, that define the specification limits, two green dashed lines shall be drawn. (Note exception in Section 4.1.11). These lines shall be located parallel to the specification lines and at a distance from each specification line equal to approximately twenty (20) percent of the specification range. The band (area) between the green dashed lines and the specification line shall be known as the caution band. This band may be shaded a light yellow or amber to symbolize the caution which the contractor shall exercise to prevent the quality of his/her work from going outside the specification limits.
- 4.1.11 For screens specifying only 100 percent passing, plotting of caution band is not applicable. Also, when the lower specification limit is zero, plotting of the lower caution band is not necessary.
- 4.1.12 Plotting of Test Data – Individual test values shall be plotted with a blue color pen, or pencil, using the symbol O. [For paper charts the circle shall be approximately 1/10 (0.1) inch in diameter.]
- 4.1.13 Averages of consecutive test values shall be plotted with a red color pen, or pencil, using the symbol □. [For paper charts the square shall be approximately 1/10 (0.1) inch on either side.]
- 4.2 Computer Generated Charts

- 4.2.1 Standard variable control computer generated charts allowing hand plotting or computer plotting of individual data may be used under the following constraints: The chart sequence shall display the applicable sieve sizes vertically in descending order from top to bottom of the display in the least number of pages as practical when printed. The screen display shall show horizontally on any given sieve at least eight potential data areas.
- 4.2.2 The item number and/or description of the material shall be noted on the top of the chart and visible at all times.
- 4.2.3 Control charts shall be maintained at the project office or at the testing site where applicable. These charts must be kept current, printed daily when applicable, and prominently displayed vertically in the specified sieve sequence (from largest sieve to smallest sieve). When printed, the most recent sheet(s) shall be displayed, and the previous sheets shall be placed chronologically in a holder
- 4.2.4 Scale – To the extent possible, the control chart shall have a vertical scale which visualizes the differences in tolerances limits between the specified sieves.
- 4.2.5 On the horizontal scale the test values shall be plotted on heavy, vertical lines, progressing from the left to the right.
- 4.2.6 General Arrangement – Control charts shall be arranged on the computer screen (and when printed and displayed) in the manner described hereinafter.
- 4.2.7 The largest sieve size shall be located toward the top of the chart and the smallest sieve size toward the bottom of the chart. The spacing between the lower limit of one sieve and the upper limit of the bordering sieve shall be such that a clear demarcation between sieves is provided.
- 4.2.8 The vertical scale for each sieve shall be arranged so that the heavy lines shall have a value of zero or a value which is a multiple of five. For instance, zero, five, ten, fifteen, etc.
- 4.2.9 General construction of the control chart shall be the same as described in Sections 4.1.9 through 4.1.13 as applicable.

---

**5. PLOTTING TEST DATA**

- 5.1 Symbols and Color Code
  - 5.1.1 Individual test values shall be plotted in a blue color using the symbol described in Section 4.1.12
  - 5.1.2 Averages of consecutive test values shall be plotted with a red color using the symbol described in Section 4.1.13.
- 5.2 Individual Test Values and Moving Average.

- 5.2.1 Test values shall be rounded to the nearest whole percentage point and plotted, except the No. 200 sieve shall be rounded to the nearest one tenth (0.1) percentage point then plotted.
- 5.2.2 The average at the start of the job begins with the second sample result. This average shall be plotted on the appropriate line on the control chart. Likewise, the average is continued for the third through fourth result, averaging all previous results and plotting each of these averages on the appropriate line on the control chart. The moving average shall be considered to be the average of five consecutive test values and is determined by starting with the fifth test value and averaging it with the four preceding test values. Thereafter only the last consecutive five sample result shall be averaged, i.e., second test value through sixth test value, third test value through seventh test value, and so forth. All averages shall be plotted on the control chart in the manner described in Section 4.1.13 and rounded in the manner described in Section 5.2.1.
- 5.2.3 As successive symbols are plotted across the control chart, from left to right, the blue symbol O (individual value) shall be connected with a dashed blue line as depicted in Attachment 1, and the red symbols shall be connected with a solid red line as depicted in Attachment 1.
- 5.2.4 All additional samples, if taken, shall be plotted on successive heavy vertical lines and treated in the same manner as above.
- 5.2.5 At the bottom of the cross-section paper, or below the last (smallest) represented sieve size printed from the computer, and immediately left of the vertical line on which test data is plotted, the following information shall be written:
1. The laboratory number assigned to the test.
  2. The initials of the person plotting the test data.
  3. The date the sample was taken.

---

**6. INDIVIDUAL OR MOVING AVERAGE TEST VALUES OUTSIDE THE SPECIFICATIONS**

6.1 Individual Test Values

- 6.1.1 When the individual test value on a sieve is outside the specification limits, or differs markedly from those preceding it, the Project Engineer/Supervisor and the contractor shall be promptly advised. The contractor shall immediately take any steps that may be necessary to bring the production under control.

6.2 Moving Average

- 6.2.1 When an average value of consecutive tests falls in the caution zone the contractor shall be advised that the material is, or is becoming, borderline, and the following notation shall be made in the plant or project diary:

“Contractor advised that \_\_\_\_\_ material is borderline”. (Write item number for base course or aggregate size and item number for other material in the blank space).

6.3 Material Outside Specification Limits

6.3.1 When three consecutive individual test values are outside the specification limits or when an average of consecutive tests falls outside the specification limits the contractor shall be promptly advised that the material is non-conforming, and the contractor shall immediately take any necessary steps to correct the deficiencies. When an average falls outside of the specification limits and the two immediately following individual test values are also outside the specification limits, operations shall be discontinued until the contractor gives reasonable assurance that the deficiency has been corrected. After the contractor has taken significant steps to correct the deficiency the next individual sample that meets the specifications after production is resumed shall be used to start a new average.



01/04/2023

---

Ronald L. Stanevich, PE, Director  
Materials Control, Soils & Testing Division

MP 300.00.51 Steward – Aggregate & Soils Section  
RLS:M  
ATTACHMENT



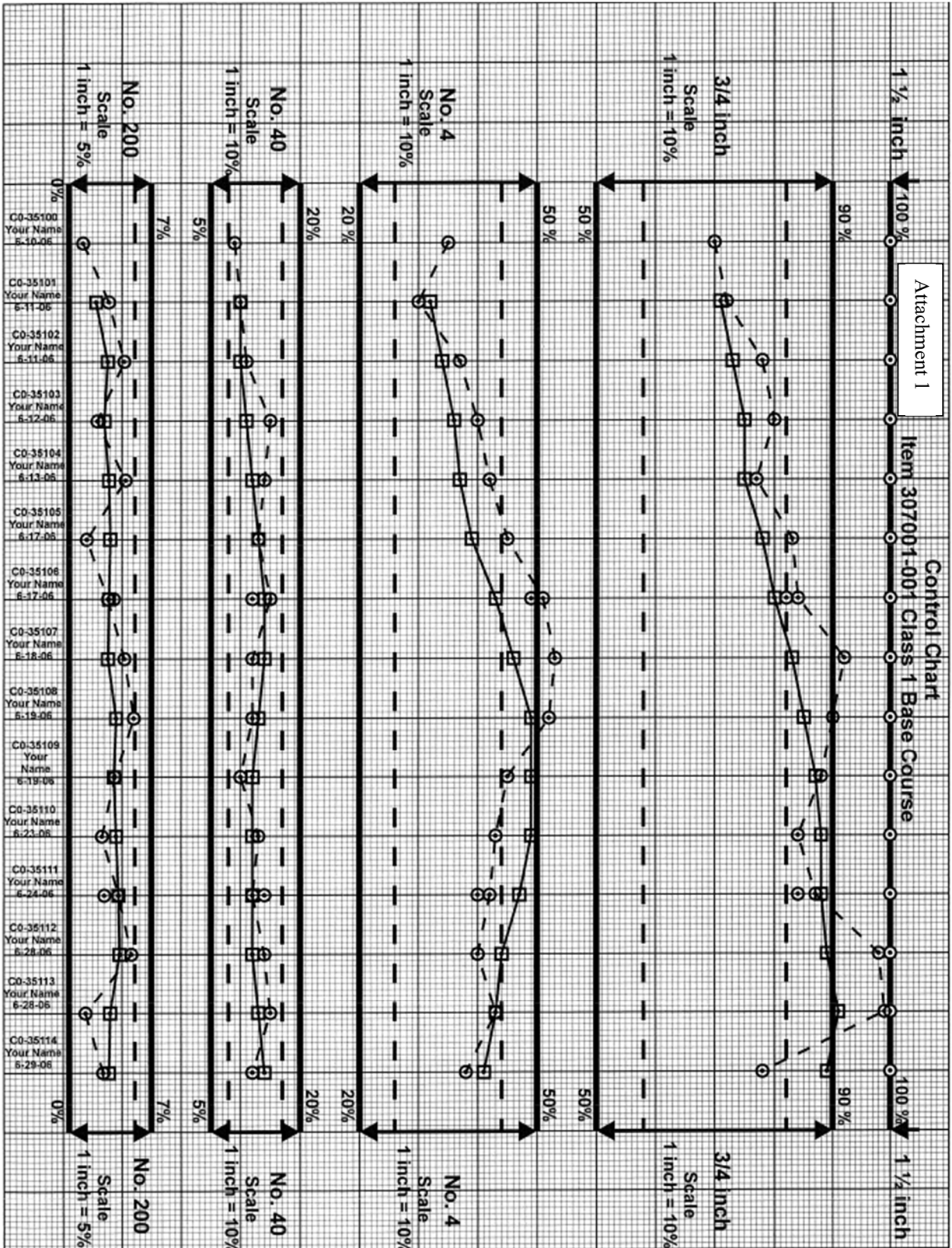

WEST VIRGINIA DEPARTMENT OF TRANSPORTATION  
DIVISION OF HIGHWAYS  
MATERIALS CONTROL, SOILS AND TESTING DIVISION

MATERIALS PROCEDURE

---

GUIDE FOR QUALITY CONTROL AND ACCEPTANCE PLANS  
FOR SUBGRADE, BASE COURSE, AND AGGREGATE ITEMS

---

**1. PURPOSE**

- 1.1 The purpose of this Materials Procedure (MP) is to establish minimum requirements for the Contractor's Quality Control (QC) Program and Acceptance Plan. It is intended that these requirements be used as a procedural guide in detailing the inspection, sampling, and testing deemed necessary to maintain compliance with the material and Specification requirements.
- 1.2 To establish procedural guidelines for approval and documentation of the Master QC Plan.
- 

**2. SCOPE**

- 2.1 This procedure is applicable to Aggregate items placed in the field. It outlines the quality control procedures for items used and includes procedures for approving and using a Master and/or Project Specific Quality Control (QC) Plan. This procedure also aids in documentation and retention of the QC Plan in ProjectWise.
- 

**3. REFERENCED DOCUMENTS**

- 3.1 MP 109.00.21 - Basis for Charges for Non-Submittal of Sampling & Testing Documentation by the Established Deadline
- 3.2 MP 300.00.51 - Procedural Guidelines for Maintaining Control charts for Aggregate Gradations
- 3.3 MP 700.00.54 - Procedure for Evaluating Quality Control Sample Test Results with Verification Sample Test Results
- 3.4 MP 700.00.06 - Aggregate Sampling Procedures
- 3.5 ML-25, Procedure for Monitoring the Activities Related to Sieve Analysis of Fine and Coarse Aggregate
- 3.6 WV Division of Highways Construction Manual, Current Edition
- 

**4. GENERAL REQUIREMENTS**

- 4.1 The Contractor shall provide and maintain a QC system that will provide reasonable assurance that all materials and products submitted to the District for acceptance will conform to the contract requirements whether natural, manufactured or processed by the Contractor or procured from suppliers, subcontractors, or vendors. The Contractor shall perform or have performed the inspections and tests required to substantiate product conformance to contract document requirements and shall also perform or have performed all inspections and tests otherwise required by the contract. The Contractor's QC

inspections and tests shall be documented and shall be available for review by the Engineer/District throughout the life of the contract. The Contractor shall maintain standard equipment and qualified personnel as required by the Specifications to assure conformance to contract requirements. Procedures will be subject to the review of the District before the work is started.

---

## 5. QUALITY CONTROL PLAN

- 5.1 The Contractor shall prepare a QC Plan detailing the type and frequency of inspection, sampling, and testing deemed necessary to measure and control the various properties of materials and construction governed by the Specifications. As a minimum, the sampling and testing plan shall detail sampling location, sampling techniques, and test frequency to be utilized. Attachment #1 shows guidelines for the QC Plan. QC sampling and testing performed by the Contractor may be utilized by the District for acceptance.
- 5.1.1 A QC Plan must be developed by the Contractor and submitted to the Engineer/District prior to the start of construction on every project. Acceptance of the QC Plan by the Engineer/District will be contingent upon its concurrence with these guidelines.
- 5.2 As work progresses, an addendum(s) may be required to the QC Plan to keep the QC program current. Personnel may be required to show proof of certification for testing.
- 5.3 QC Plan Guidelines: The QC plan shall include but not be limited to the following information:
- 5.3.1 Name of company official responsible for QC program. Contact phone number(s) and email(s) shall be included in the cover letter.
- 5.3.2 List certified personnel as specified in Section 106 of the Specifications, whether from the submitting company, consultant testing firm, or both.
- 5.3.3 List of the Aggregate items to be controlled by QC Plan.
- 5.3.4 Sampling and Testing Plan: As a minimum, the sampling and testing plan should detail sampling locations, test methods, and test frequencies to be used. To facilitate the District's monitoring activities, which are described in Section 7.1, all completed gradation samples must be retained by the Contractor until further disposition is designated by the District Materials Supervisor. The QC Plan should state where and how these samples will be maintained. Applicable sections of Materials Letter ML-25 should be used for guidance.
- 5.3.5 Testing Facility: The plan shall state the specific location where the samples(s) will be tested and retained.
- 5.3.6 Documentation Plan: The Contractor's plan to document and distribute test results shall be described.
- 5.3.7 Forms and Distribution: Approved processing forms available on the [MCS&T Webpage](#)<sup>1</sup> shall be used to record the test data. Gradation tests will be recorded on Form T300. The lab

---

<sup>1</sup> <https://transportation.wv.gov/highways/mcst/Pages/tbox.aspx>

oratory reference number will always start with a "C" for all QC samples taken and tested by the Contractor. One copy of each completed form should be retained by the Contractor until the work is completed and accepted. The original signed copy of the test data is to be delivered to the District Materials Supervisor. To be an effective QC function, tests must be completed and results distributed in a regular and timely manner. The plan, therefore, must state what action will be taken in the event that testing and reporting are not completed in a reasonable period of time - preferably within 72 hours after the sample is taken (at the discretion of the District).

5.3.8 Control Charts: The Specifications require the plotting of gradation test results on control charts using the moving average concept as described in MP 300.00.51. The QC Plan should state where and how the charts shall be maintained and made available to District personnel. These charts are part of the District's acceptance procedures and must be available to the District when the project is completed or at the request of the District personnel. At the Contractor's request, the requirement of Control Charts may be waived on a per project basis. The Contractor will submit a written request to the District asking that the Control Charts be waived. The District will make a determination based on the size of the project and the number of gradation tests required.

5.3.9 Disposition of Non-Specification Material: The Contractor shall provide a detailed plan of action for the immediate notification of all parties involved in the event that nonconforming situations are detected.

5.3.10 Delivery Tickets

Each truckload of aggregate delivered at the project shall be accompanied by delivery ticket with all the following information:

1. Ticket number
2. Producer/Supplier Code
3. Producer/Supplier Name
4. Producer/Supplier Location
5. Contract Identification Number (CID #)
6. Federal Project Number (If applicable)
7. State Project Number
8. Date/Time
9. Material Code/Name
10. License Number of Haul Unit or Truck Number
11. Load Number
12. Gross Truck Weight
13. Tare Truck Weight
14. Net Weight
15. Weighperson's Name certifying that all information on the ticket is correct.

The following information shall be documented on the ticket by the project:

1. Contract Item Number
2. Contract Line Number

5.3.10.1 Documentation shall be provided to the project as per the requirements of Section 109.20 of the Specification.

5.3.11 Types of QC Plans

5.3.11.1 QC Plans which are intended for use on more than one project shall be defined as Master QC Plans. Section 6.1 outlines the procedures for Master QC Plan submittal and approval.

5.3.11.2 QC Plans which are intended for use on a single project shall be defined as Project Specific QC Plans. Project Specific QC Plans shall contain a cover letter which includes the following: project description, CID#, and Federal and/or State Project Number.

5.3.11.3 A contractor may submit a project specific cover letter referencing the Master QC plan instead of a Project Specific QC Plan.

5.3.11.4 Once any QC Plan is approved for a project, the key-date shall be entered in Site Manager by the appropriate District Materials personnel. The first date entered shall be the date the Project QC Plan letter is received. The second date shall be when the District approves the QC Plan for use on the project.

---

**6. MASTER QUALITY CONTROL PLAN**

6.1 The intent of a Master QC Plan is to facilitate the approval process in a more uniform manner. The Contractor may submit a Master QC when their workload in a given District is routinely repetitive for the year. Testing includes both performing the test and submitting the results as per MP 109.00.21.

6.1.1 The Contractor may submit a new Master Aggregate Items QC Plan each year to each District in which they have or expect to have work (see Attachment #2 for an example). If the Contractor does not have work or does not have a history of work in a given District for the year, then a Master Field QC Plan shall not be submitted to that District.

6.1.2 The District will review the submitted Master QC Plan to see if it meets the requirements for the Aggregate Items in the QC Plan as per Section 5.3. If accepted, the District shall assign a laboratory reference number to the Master QC Plan for future referencing. The District will acknowledge approval of each Master QC Plan to the Contractor by letter (see Attachment #3 for an example), which will include the laboratory reference number and a copy of the approved Master QC Plan. This will then be scanned and placed in ProjectWise under the appropriate District's Org for that Contractor and/or Producer/Supplier.

6.1.3 Once a project has been awarded, if a Contractor elects to use the approved Master Aggregate Items QC Plan on that project, the Contractor shall submit a letter requesting to use the Master QC Plan for that project. This letter must be on the Contractor's letterhead, be addressed to the District Engineer/Manager or their designee, and contain the following information: project number, CID#, project description, type of QC Plan, and the laboratory reference number for the Master QC Plan. (See Attachment #4 for an example).

6.1.4 The District shall review the referenced Master QC Plan to ensure it covers all items in the project. If the referenced Master QC Plan is found to be insufficient for some items on the project, the District shall request the Contractor to submit additional information for QC of those items as an addendum on a project specific basis. When the District is satisfied with the QC Plan for this project, a letter shall be sent to the Contractor acknowledging

approval (see Attachment #5 for an example), with the following attached: the Contractor's project QC Plan request letter and the Master QCP approval letter. This shall then be placed in the project's incoming-mail mailbox in ProjectWise.

- 6.1.5 A Master QC Plan that has been approved for project use shall be good for the duration of that project, even if that project continues into future calendar years.
- 6.1.6 For the use of District Personnel, the District approval letter for this project must state the ProjectWise link to the referenced Master QC Plan for that Contractor. For example, WVDOT ORGS > District Organization #> Materials > Year>Master QC Plans, etc.
- 6.1.7 The Master Aggregate items QC Plan shall be valid for the duration of one calendar year beginning on January 1st and ending on December 31st.

---

## 7. ACCEPTANCE PLAN

- 7.1 Per 307.2 of the Specifications, the acceptance (verification) sampling and testing is the responsibility of the District and QC tests are the responsibility of the Contractor. Acceptance activities (sampled and tested at the frequency given in Section 7.1.2) may be accomplished by conducting verification sampling and testing completely independent of the Contractor and, in some cases, by witnessing tests performed by the Contractor, or by a combination of the two. The following guidelines provide a system, which should result in sufficient confidence in the Contractor's documentation of their QC operations to permit acceptance of the material in accordance with the procedure set forth in the Specifications.
  - 7.1.1 The District shall review all information supplied by the Contractor on the QC Plan. Note, in particular, the qualifications of the sampler, tester, the location, and other qualifying statements about the testing facility. In the event that little qualifying information is supplied or has been demonstrated by the testing facility: Prior to work, the District (or their representative) shall review the availability, type, and suitability of the testing equipment and verify all calibrations. This information should be documented and kept available at the District Materials Section.
  - 7.1.2 The District shall sample and test, completely independent of the Contractor, at a frequency equal to or greater than ten (10) percent of the frequency for testing given in the approved QC Plan. Witnessing the Contractor's sampling and testing activities may also be a part of the acceptance procedure, but only to the extent that such tests are considered "in addition to" the ten (10) percent independent tests.
  - 7.1.3 Plot the results of gradation tests performed by the District on the Contractor's QC charts with a red circle, but do not include these values in the moving average. When the Contractor's tests are witnessed, circle the Contractor's test result on the control chart with red. These values are used in the moving average calculations. The laboratory number will always start with an "M" for all acceptance (verification) samples taken and tested in this manner by the District, and will always start with a "0" for all of the Contractor's tests, which are witnessed by the District.
  - 7.1.4 Evaluate the results of acceptance (verification) tests, whether performed or witnessed by the District, in accordance with MP 700.00.54.

- 7.2 If the evaluation indicates similarity with the QC test(s), the control chart will be considered acceptable to that point.
- 7.2.1 If dissimilarity is determined, an immediate investigation shall be conducted in an effort to determine the cause. Until the situation is resolved, any samples held in accordance with ML-25 will be retained and may be used in whatever manner deemed appropriate during the investigation.
- 7.3 Implement ML-25 for aggregate gradations.

---

**8. ABSENT TESTING OF MATERIAL**

- 8.1 If the Contractor fails to perform testing of the material in accordance with the Contractor's Division Approved Quality Control Plan, payment for the portion of the item represented by the absent test shall be withheld, pending the Engineer's decision whether or not to allow the material to remain in place. Testing includes both performing the test and submitting the results as per MP 109.00.21.
- 8.1.1 If the Engineer allows the material to remain in place, the Division shall not pay for the material represented by the absent test. However, the Division shall pay for the cost of the placement of the material, including labor and equipment. The invoice or material supplier cost (if applicable), determined at the time of shipment, shall be used to calculate the cost of material when evaluating the total cost of labor and equipment.

---

**9. MATERIAL TEST DATA**

- 9.1 The Contractor's Quality Control Plan shall clearly state the name(s) of the individual(s) entering test data as outlined in MP 109.00.21.

**Michael Mance** Digitally signed by Michael Mance  
Date: 2024.08.01 14:22:04 -04'00'

---

Michael A. Mance, P.E.  
Interim Director  
Materials Control, Soils & Testing Division

MP 307.00.50 Steward – Aggregate and Soils Section  
MM: R  
ATTACHMENTS

**ATTACHMENT #1 - GUIDELINES FOR CONTRACTOR'S QUALITY CONTROL**

<b>Item Description</b>	<b>Property</b>	<b>Minimum Frequency</b>
207 Subgrade	Gradation	One (1) sample per day of placement. Note 1
	Atterburg Limits	From an approved aggregate source: one (1) test at the beginning of placement and then each 10,000 tons. Not from an approved aggregate source a minimum of one (1) test per 6 days placement.
212 select Material for Backfill	Gradation	Minimum of one (1) sample per day of Placement. Note 1
307 Crushed Aggregate	Gradation	One (1) sample per each one-half (1/2) day placement. Note 1
	Atterburg limits	One(1) test at the beginning of placement and then each 10,000 tons thereafter
	Other tests as requested by the Division or required by the contract documents: percent crushed particles, unit weight, etc.	As requested by the Division or required by the contract documents.
307 Aggregate Shoulder course for Resurfacing Projects	Gradation	One (1) sample per day of placement. Note 1
	Atterburg limits	One (1) test at the beginning of placement and then each 10,000 tons thereafter
	Other tests as requested by the Division or required by the contract documents: percent crushed particles, unit weight, etc.	As requested by the Division or required by the contract documents.



**ATTACHMENT #1 GUIDELINES FOR CONTRACTOR'S QUALITY CONTROL (CONTINUED)**

604 Class 1 Aggregate	Gradation	Minimum of one (1) sample per day of placement. Note 1
606 Aggregate for Underdrain	Gradation	Minimum of one (1) sample per day of placement. Note 1
609 Bed Course Material	Gradation	Minimum of one(1) sample per day of placement. Note 1
626 Aggregate	Gradation	Minimum of one (1) sample per day of placement. Note 1
	Atterburg Limits	From an approved aggregate source: one (1) test at the beginning of placement and then each 10,000 tons. Not from an approved aggregate source a minimum of one (1) test per 6 days placement.
636 Aggregate	Gradation	One (1) sample per each one-half (1/2) day of placement. Note 1: Note 2
	Atterburg Limits	One (1) test at beginning of placement and then each 10,000 tons thereafter. Note 2

**Note 1:** In the event project activities are such that relatively small quantities of material are being placed per placement date, and to prevent over sampling, the Engineer may approve the following alternate sampling method: A minimum of One (1) sample per six (6) consecutive days shall be taken to represent up to each 170 cubic yards (250 tons). Sampling is to be done on the first day of aggregate placement. In this case the sample shall be taken at a random time and place

**Note 2:** When Aggregate for maintaining traffic is not to be part of any succeeding base or pavement course, the appropriate aggregate size shall be determined by the Engineer. If the aggregate is from an approved source, then it shall be accepted by visual inspection. If the Contractor elects to use aggregate from an unapproved source, test results shall be provided to show that the liquid limit and plasticity index meet the requirements in Table 704.6.2B

\*\*\* ATTACHMENT #2 - EXAMPLE GUIDE FOR AGGREGATE ITEMS QUALITY CONTROL PLAN \*\*\*

The Acme Company  
20 First St.  
Somewhere, WV XXXXXXXX

Mr./Ms/Mrs. \_\_\_\_\_  
WV Division of Highways  
District \_\_\_ Engineer/Manager  
\_\_\_\_\_, WV

RE: “year” Master Aggregate Items QC Plan  
DISTRICT: \_\_\_\_\_

Dear Mr./Ms/Mrs. \_\_\_\_\_

We are submitting our Master QC Plan for Aggregate Items , developed in accordance with the (year) WVDOH Standards and Specifications, (year)WVDOH Supplemental specifications, MP300.00.51, MP 700.00.54, ML-25, and AASHTO Testing standards.

The Quality Control Program is under the direction of \_\_\_\_\_. They can be contacted by telephone number \_\_\_\_\_, email \_\_\_\_\_ and/or in person.

- 1.) All testing will be performed by qualified personnel as per WVDOH Specification Section 106 Control of Materials. Proof of personnel certification shall be provided to WVDOH inspectors upon request.
- 2.) Specify items to be controlled and the methods by which each item will be tested (For example:207,307...etc) Attachment #1 summarizes the different materials, minimum frequencies, and the appropriate test procedure or method for controlling each material.  
  
- 207 Items    - 212 Items    -307 Crushed Aggregate Items    - ETC>>>>>
- 3.) List the location (address) and lab where testing will be performed.
- 4.) State the method and means by which that Contractor will document and distribute test results.
- 5.) State what forms will be used for tests the time frame for completing testing and distributing of test information to District Materials.

- 6.) Specify in the QC Plan where and how the charts will be maintained and made available to Division/District personnel. Control Charts will use the moving average concept as described in MP 300.00.51.
- 7.) Specify a plan of action providing for immediate notification of all parties involved in the event that nonconforming material situations are detected.

Very Truly Yours,

---

Title

\*\*\*\*\* ATTACHMENT #3 WVDOH LETTERHEAD \*\*\*\*\*

ACME Company  
20 First St.  
SOMEWHERE, WV #####

RE: Aggregate Items Master QC Plan  
Description: (Year) Construction Season

Dear Mr./Ms/Mrs. \_\_\_\_\_,

Your Master Aggregate Quality Control Plan (M#-#####) for  
\_\_\_\_\_ has been reviewed and found to be acceptable for the following  
items:

- 207 Aggregate Items      - 212 Aggregate Items
- 307 Aggregate Items      - ETC

As work progresses throughout the season, an addendum(s) may be required to this QCP to keep the QC program current. **Also note that personnel may be required to show proof of certification for testing. Please use Lab Reference # M#-##### when corresponding about this QC plan.** Please make sure that all appropriate personnel have a copy of this plan in their possession.

Very Truly Yours,

\_\_\_\_\_  
Title

\*\*\*\*\* ATTACHMENT #4 - EXAMPLE \*\*\*\*\*

THE ACME COMPANY INC.  
20 First St.  
Somewhere, WV XXXX

Mr./Ms/Mrs \_\_\_\_\_  
WV Division of Highways  
District \_\_\_\_ Engineer/Manager  
\_\_\_\_\_, WV \_\_\_\_\_

Subject: Aggregate Items QC plan  
For project

Fed. Project No \_\_\_\_\_  
State Project No. \_\_\_\_\_  
Contract ID No. \_\_\_\_\_  
Description \_\_\_\_\_

Dear Mr./Ms/Mrs. \_\_\_\_\_,

We would like to use our approved Aggregate Items Master Quality Control Plan, reference number \_\_\_\_\_ for the project referenced above. We feel that all items on the referenced project are covered by the Master Quality Control Plan for Aggregate Items.

The QC Plan is under the direction of \_\_\_\_\_,  
\_\_\_\_\_ (title), and will be the Company's contact representative to the Division of Highways District Materials and Construction Departments. They can be contacted in person at the project, by telephone \_\_\_\_\_ or at email account \_\_\_\_\_.

Very Truly Yours,

\_\_\_\_\_  
Title

\*\*\*\*\* ATTACHMENT #5 - WVDOH LETTERHEAD \*\*\*\*\*

THE ACME COMPANY INC.  
20 First St.  
Somewhere, WV XXXXX

RE: \_\_\_\_\_ Aggregate Items QC Plan

Project CID#: #####  
Fed/State Project #: #####- ## - #####.##  
Description: Falling Slide  
County : XXXXXXX

Dear Mr./Ms/Mrs. \_\_\_\_\_,

Your request to use your Master Aggregate Items Quality Control Plan (M# - #####) for Aggregate Items on the project referenced above, has been reviewed and found to be acceptable for the following items:

- 207 Aggregate Items
- 212 Aggregate Items
- 307 Aggregate Items
- ETC

As work progresses throughout this project an addendum(s) may be required to this QCP to keep the QC program current. **Please use M# - ##### when corresponding about this QC plan. Also note that personnel may be required to show proof of certification for testing.** Please make sure that all appropriate personnel have a copy of this plan in their possession.

**For Division/District use**

The Master Quality Control Plan can be reviewed in ProjectWise at this Link:

WVDOT ORG>D0#>year>MASTER QC PLANS>Contractors or Plant>Contractor Name>Name of Quality Control Plan

Very Truly Yours,

\_\_\_\_\_  
Title

WEST VIRGINIA DEPARTMENT OF TRANSPORTATION  
DIVISION OF HIGHWAYS  
MATERIALS CONTROL, SOILS AND TESTING DIVISION

MATERIALS PROCEDURE

---

STANDARD METHOD FOR DETERMINATION OF  $\bar{A}$  OF THE  
TOTAL SOLIDS IN PORTLAND CEMENT CONCRETE

---

**1. PURPOSE**

- 1.1 To establish a procedure for determining the  $\bar{A}$  of the total solids contained in portland cement concrete.
- 1.2 To establish a uniform definition of  $\bar{A}$ .
- 

**2. SCOPE**

- 2.1 This procedure shall apply in all cases where the specification requires the determination of  $\bar{A}$  of the total solids in portland cement concrete.
- 

**3. DEFINITIONS**

- 3.1  $\bar{A}$  (A-Bar) – A factor that characterizes the gradation of an aggregate. The size of the factor is very highly correlated with the aggregate surface area. The  $\bar{A}$  factor is used as a control in concrete mix designs.
- 

**4. PROCEDURE**

- 4.1 Since the solids contained in a portland cement concrete mix consist of coarse aggregate, fine aggregate, and portland cement, this procedure will address the determination of  $\bar{A}$  of these solids in combination.
- 4.1.1 The mass of the solid materials used in the mix proportions shall be used to determine the percent of each constituent material in the total solids.
- 4.1.1.1 Determine the total mass of solids:  $M_{ca} + M_{fa} + M_c = M_t$

Where:

$M_{ca}$  = mass of coarse aggregate (SSD) used in one cubic yard (meter) of concrete.

$M_{fa}$  = mass of fine aggregate (SSD) used in one cubic yard (meter) of concrete.

$M_c$  = mass of cement used in one cubic yard (meter) of concrete.

$M_t$  = total mass of solids in one cubic yard (meter) of concrete.

Determine the fractional part of each solid (solid fraction):

$$\frac{M_{ca}}{M_t} = \text{fractional part of coarse aggregate in the mix}$$

$$\frac{M_{fa}}{M_t} = \text{fractional part of fine aggregate in the mix}$$

$$\frac{M_c}{M_t} = \text{fractional part of cement in the mix}$$

4.1.2 Determine the gradation of each of the individual materials using standard procedures with the following modifications.

4.1.2.1 When determining the fine aggregate gradation, include Standard Sieve sizes 3/8 inch (9.5 mm), No. 4 (4.75 mm), No. 8 (2.36 mm), No. 16 (1.18 mm), No. 30 (600  $\mu\text{m}$ ), No. 50 (300  $\mu\text{m}$ ), No. 100 (150  $\mu\text{m}$ ), and No. 200 (75  $\mu\text{m}$ ).

4.1.2.2 When determining the coarse aggregate gradation, all material passing the smallest specification sieve shall be sieved through either eight or twelve inch sieves. Only a minor amount of material will be retained on any sieves above the No. 200. This amount of material is considered to be insignificant and is added to the amount retained on the No. 200 sieve.

4.1.3 Determine the Solid  $\bar{A}$ 's. The Solid  $\bar{A}$  of each constituent shall be determined by adding the cumulative percentages by mass of material passing each of Standard Sieve sizes 1 1/2 inch (37.5 mm), 3/4 inch (19 mm), 3/8 inch (9.5 mm), No. 4 (4.75 mm), No. 8 (2.36 mm), No. 16 (1.18 mm), No. 30 (600  $\mu\text{m}$ ), No. 50 (300  $\mu\text{m}$ ), No. 100 (150  $\mu\text{m}$ ), and No. 200 (75  $\mu\text{m}$ ) and dividing by 100.

4.1.4 Determine the  $\bar{A}$  of each of the solids using the fractional parts (solid fractions) from 4.1.1.2 and the Solid  $\bar{A}$  of each constituent from 4.1.3.

$$\bar{A}_{ca} = \text{fractional part of coarse aggregate} \times \text{Solid } \bar{A} \text{ of coarse aggregate}$$

$$\bar{A}_{fa} = \text{fractional part of fine aggregate} \times \text{Solid } \bar{A} \text{ of fine aggregate}$$

$$\bar{A}_c = \text{fractional part of cement} \times \text{Solid } \bar{A} \text{ of cement}$$

Where:

$$\bar{A}_{ca} = \bar{A} \text{ of coarse aggregate}$$

$$\bar{A}_{fa} = \bar{A} \text{ of fine aggregate}$$

$$\bar{A}_c = \bar{A} \text{ of cement}$$



4.1.5 Determine the  $\bar{A}$  of the Total Solids:

$$\bar{A} \text{ Total Solids} = \bar{A}_{ca} + \bar{A}_{fa} + \bar{A}_c$$



08/31/2022

---

Ronald L. Stanevich, P.E.  
Director  
Materials Control, Soils and Testing Division

MP 601.03.51 Steward – Cement and Concrete Section  
RLS:T  
ATTACHMENT

EXAMPLE OF CALCULATIONS  
A TOTAL SOLIDS

1. Total mass of solids in one cubic yard (meter) of concrete:

$$M_{ca} = \text{Mass of SSD Coarse Aggregate} = 1800 \text{ lb. (816 kg)} \quad M_{fa} =$$

$$\text{Mass of SSD Fine Aggregate} = 1100 \text{ lb. (499 kg)} \quad M_c = \text{Mass of}$$

$$\text{cement} = 600 \text{ lb. (272 kg)}$$

$$M_t = \text{Total mass of Solids}$$

$$M_t = M_{ca} + M_{fa} + M_c$$

$$M_t = 1800 \text{ lb. (816 kg)} + 1100 \text{ lb. (499 kg)} + 600 \text{ lb. (272 kg)} = 3500 \text{ lb. (1587 kg)}$$

2. Fractional part of each solid:

$$\frac{M_{ca}}{M_t} = \frac{1800 \text{ lb. (816 kg)}}{3500 \text{ lb. (1587 kg)}} = 0.514$$

$$\frac{M_{fa}}{M_t} = \frac{1100 \text{ lb. (499 kg)}}{3500 \text{ lb. (1587 kg)}} = 0.314$$

$$\frac{M_c}{M_t} = \frac{600 \text{ lb. (272 kg)}}{3500 \text{ lb. (1587 kg)}} = 0.171$$

3. Determination of the Solid  $\bar{A}$  of each constituent:

PERCENT PASSING

<u>Sieve Size</u>	<u>Coarse Aggregate</u>	<u>Fine Aggregate</u>	<u>Cement</u>
1 1/2 in. (37.5 mm)	100	100	100
3/4 in. (19.0 mm)	84	100	100
3/8 in. (9.5 mm)	21	100	100
No. 4 (4.75 mm)	2	98	100
No. 8 (2.36 mm)	1	83	100
No. 16 (1.18 mm)	0	65	100
No. 30 (600 $\mu$ m)	0	48	100
No. 50 (300 $\mu$ m)	0	13	100
No. 100 (150 $\mu$ m)	0	3	100
No. 200 (75 $\mu$ m)	0.5	1.5	100
Totals	208.5	611.5	1000
Solid $\bar{A}$ 's	2.08	6.12	10

4. Determine the  $\bar{A}$  of each of the solids:

$$\begin{aligned} \bar{A}_{ca} &= 0.514 \times 2.08 = 1.07 \\ \bar{A}_{fa} &= 0.314 \times 6.12 = 1.92 \\ \bar{A}_c &= 0.171 \times 10 = 1.71 \end{aligned}$$

5. Determine the  $\bar{A}$  of the Total Solids:

$$\bar{A}_{\text{Total Solids}} = 1.07 + 1.92 + 1.71 = 4.70$$

WEST VIRGINIA DEPARTMENT OF TRANSPORTATION  
DIVISION OF HIGHWAYS  
MATERIALS CONTROL, SOILS AND TESTING DIVISION

MATERIALS PROCEDURE

---

AGGREGATE SAMPLING PROCEDURES

---

**1. PURPOSE**

- 1.1 To provide a uniform procedure for obtaining aggregate samples.
- 

**2. SCOPE**

- 2.1 This procedure shall apply to the following:
- (a) Process Control sampling by the Contractor.
  - (b) Acceptance Sampling by the Division.
  - (c) Independent Assurance Sampling by the Division.
  - (d) Record Sampling by the Division.
- 

**3. GENERAL**

- 3.1 Taking a good sample is just as important as conducting a good test. The sampler must use every precaution to obtain samples that will show the true nature and condition of the material they represent.
- 3.2 Most aggregates are mixtures of various particle sizes, which tend to separate, or segregate, during transporting or stockpiling. For this reason, aggregate samples should be obtained at the last practical point before the material is incorporated into the finished product or before compaction.
- 3.3 Frequency of sampling will be in accordance with the applicable directives for the type sample being procured.

---

#### 4. DEFINITION OF TERMS

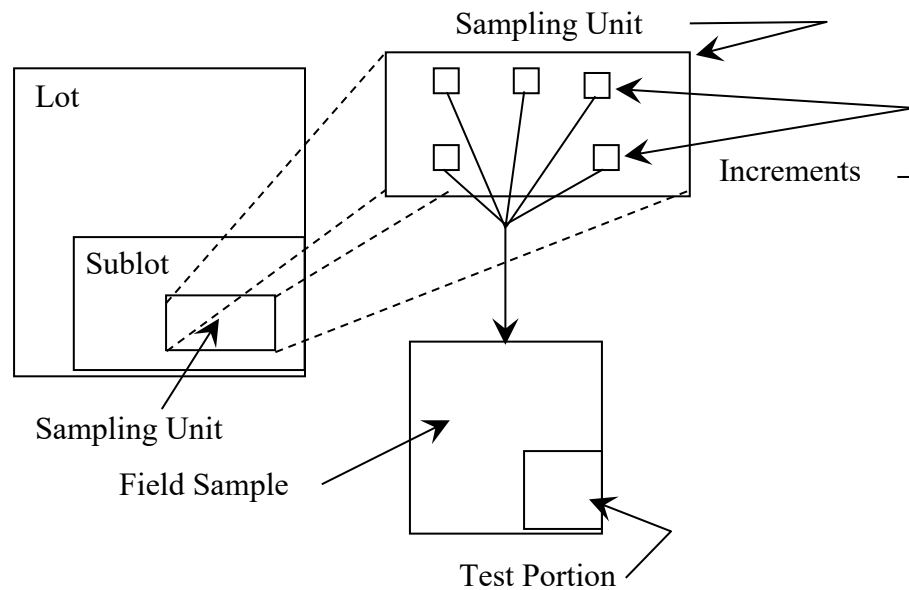

- 4.1 Lot: The quantity of material represented by an average test value, not to exceed five individual test values, calculated in accordance with MP 300.00.51.
- 4.2 Sublot: The quantity of material represented by a single test value. In the case where only one sample is needed for the total plan quantity, the subplot may be considered the Lot.
- 4.3 Sampling Unit: The quantity of material within the subplot from which increments are obtained to be combined into a field sample.
- 4.4 Increment: The portion of material removed from the sampling unit to be combined into a field sample.
- 4.5 Field Sample: A composite of increments.
- 4.6 Test Portion: The material split from the field sample to be used in performing a specific test.
- 4.7 Random Location: A location whose position depends entirely on chance. In other words, one location has as good a chance being selected as any other.

---

#### 5. CONTRACTOR RESPONSIBILITY

- 5.1 The Contractor shall provide all reasonable facilities and furnish the Division the information, assistance and samples required by the Engineer and Inspector for proper inspecting or testing of materials and workmanship.
- 5.2 All materials and each part or detail of the work shall be subject to inspection by the Engineer. The Engineer or a representative shall be allowed access to all parts of the work and shall be furnished with such information and assistance by the

Contractor as is required to make a complete and detailed inspection. To facilitate the inspection of materials, all delivery tickets shall contain as a minimum the information required in MP 700.00.01.

---

**6. SAMPLING PROCEDURES**

- 6.1 There are four general areas from which aggregate samples are usually obtained. These include (1) Sampling from the roadway after the aggregate has been placed, but prior to compaction, (2) Sampling from a conveyor belt, (3) Sampling from a flowing stream of aggregate, and (4) Sampling from stockpiles.
- 6.1.1 Sampling from the roadway (e.g., bases and subbases)
- 6.1.1.1 The first step in obtaining a roadway sample is to locate the subplot. This is usually the quantity of material that will be represented by the one sample and is defined as a section of roadway of given width and length.
- 6.1.1.2 The next step is to randomly locate a sampling unit within the subplot. A sampling unit is defined as an area having dimensions of approximately 12 feet by 12 feet, or an area of approximately 144 square feet in locations having any dimension less than 12 feet. Locating the sampling unit is accomplished by use of random numbers contained in Attachment I. Any pair of numbers (decimals) may be used to locate a sampling unit within the subplot. To locate the sampling unit in a subplot defined by area, the length of the area, in feet, is multiplied by one decimal of the pair, and width is multiplied by the other decimal. The resulting distances are to be measured from one end and one side of the area.
- 6.1.1.3 For example, a subplot of material consists of base course aggregate 26 feet wide from Station 956+00 to 965+00. The total length in feet is thus 96,500 minus 95,600, or 900 feet. A pencil tossed on Attachment I points to the pair of decimals 0.115 and 0.447. To locate the sampling unit, the first decimal is multiplied by the length of the subplot, and the companion decimal is multiplied by the width. The length value will be measured from Station 956+00 and the width value from the left-hand edge of the base. Thus, 900 multiplied 0.115 equals 104, and 26 multiplied by 0.447 equals 12, so the sampling unit would be located at Station 956+00 plus 1+04, or 957+04 at 12 feet from the left edge. This point could define the center or any corner of the sampling unit. If we use the center, a 12-foot by 12-foot sampling unit would fall between Stations 956+98 and 957+10 with longitudinal boundaries at 6 feet and 18 feet from the left edge of the base.
- 6.1.1.4 Five approximately equal increments are then located within the sampling unit. This is also best accomplished by means of the random numbers in Attachment 1. Procedures to follow are essentially the same as those set forth for locating the sample unit. The five increments are taken from the sampling unit and combined to form a field sample whose weight equals or exceeds the minimum recommended in Table I. All increments shall be taken from the roadway for the full depth of the material being sampled, care being taken to exclude any foreign material which may have been incorporated during the normal construction process. The specific areas from which each increment is to be removed shall be

clearly marked; a metal template placed over the area is a definite aid in securing approximately equal increment weights.

6.1.2 Sampling from a Conveyor Belt

6.1.2.1 The first step in obtaining a sample from the conveyor belt is to define the subplot. This is generally defined as a unit of time, i.e., a half-day or a day's production. The next step is to randomly locate a sampling unit within the subplot. A sampling unit in this case is generally considered to be the material contained within the length of the conveyor. Locating the sampling unit is accomplished by use of the random numbers contained in Attachment I. Any number may be used to locate a sampling unit within the subplot. To locate the sampling unit in a subplot defined by time, the length of time, usually in minutes, is multiplied by the random decimal obtained from Attachment I.

6.1.2.2 For example, a subplot of material consists of concrete aggregate used in a half-day's production estimated to be between 8:00 a.m. and 12:00 noon. A pencil tossed on Attachment I points to decimal 0.279. Thus, the sampling unit would be located somewhere within the four-hour period (8:00 a.m. to 12:00 noon). Four (hours) multiplied by 60 (minutes per hour) multiplied by 0.279 equals 67 minutes. The sampling unit would be located 67 minutes after the 8:00 a.m. startup; or at 9:07 a.m. (or as soon thereafter as practical).

6.1.2.3 Five randomly located, approximately equal increments are obtained from the sampling unit and combined to form a field sample whose weight equals or exceeds the minimum recommended in Table I. The location of the five increments is determined by multiplying the length of the belt by five random numbers. The conveyor belt is stopped while the increments are being obtained. Two templates, conforming to the shape of the belt and spaced such that the material contained between them will yield an increment of the required size, are inserted into the aggregate stream on the belt. All material between the templates is carefully scooped into a suitable container, including all fines on the belt collected with a brush and dustpan.

6.1.3 Sampling from a Flowing Aggregate Stream (bin or belt discharge)

6.1.3.1 Definition of the subplot and location of the sampling unit is generally identical with sampling from a conveyor belt, with the exception that the sampling unit in this case is defined as that material which will flow during a five-minute period. Once the sampling unit is located, five approximately equal increments, randomly spaced, are obtained and combined to form a field sample whose weight equals or exceeds the minimum recommended in Table I. Each increment is taken from the entire cross-section of the material as it is being discharged. It is usually necessary to have a special device constructed for use at each individual plant. This device will consist of a pan of sufficient size to intercept the entire cross-section of the discharge stream and hold the required quantity of material. A set of rails may be necessary to support the pan as it is passed under the discharge stream. If the sampling pan overflows, it should be struck level so that only material that is within the pan is retained.

6.1.4 Sampling from a Stockpile

- 6.1.4.1 If possible, stockpile sampling should be avoided when sampling to determine the gradation of an aggregate. However, circumstances sometimes make it necessary, and when this occurs a sampling plan and the number of samples to be taken must be considered for each specific case. Stockpiled aggregates tend to segregate with the coarser particles rolling to the outside base of the pile, which makes gradation representation difficult. Because of this, every effort should be made to enlist the services of power equipment (such as a front-end loader) to develop a separate small sampling pile composed of material taken from various levels and depths in the main stockpile. Increments from this pile may be combined, thoroughly mixed, and reduced by quartering and/or sample splitter to obtain the field sample. Methods for quartering and splitting samples are given in AASHTO R76. If power equipment is not available, hand sampling may be employed to obtain at least three increments per sample: One increment taken from the top one third of the pile, one from the middle and one from the bottom third. When hand sampling, the outer layer of the pile should be removed (scraped away with the shovel) at the point prior to sampling.

---

**7. WEIGHTS REQUIRED**

7.1 Field Sample Weights

- 7.1.1 Field sample weights as listed in Table I are minimum values. Actual weights required must be predicated on the type and number of tests to which the material is to be subjected. The amounts specified in Table I will provide adequate material for routine gradation and quality analysis.

7.2 Test Portion Weight

- 7.2.1 The weight of the test portion to be obtained from the field sample for a specific test will be defined in the Standard Procedures of the test involved. Reduction of the field sample into test portions is done with a sample splitter. The weight of test portion recommended for gradation testing is given in Table II.

---

**8. TRANSPORTING SAMPLES**

8.1 Testing at Site of Sampling

- 8.1.1 Samples taken for testing in the field may be placed in any suitable clean container of appropriate size which is secure enough to prevent loss of material when transporting the sample to the testing location.

8.2 Samples to be Shipped from Site of Sampling

- 8.2.1 Samples to be shipped should be placed in standard sampling sacks. If the sample contains an appreciable quantity of fine material, a plastic liner should be put in the sack to prevent loss of the fines. Each sack must be securely tied to prevent loss of material in transit. It is also essential that sample identification be maintained from the field to the testing site. Each sack must have appropriate



indelible identification attached and enclosed so that field reporting, laboratory logging, and test reporting may be facilitated.

RLS:Ms  
Attachments

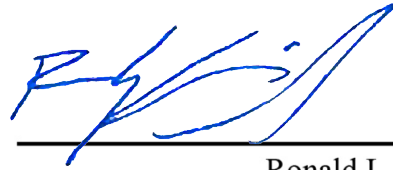

12/08/2021

---

Ronald L. Stanevich, P.E.  
Director  
Materials Control, Soils and Testing Division

**TABLE I**  
**WEIGHT OF SAMPLES**

<u>NOMINAL MAXIMUM SIZE OF PARTICLES*</u>	<u>MINIMUM WEIGHT OF FIELD SAMPLES</u>	
<u>Sieve Size</u>	<u>Kilo</u>	<u>lb</u>
No. 8	10	25
No. 4	10	25
3/8 in.	10	25
1/2 in.	15	35
3/4 in.	25	55
1 in.	50	110
1 1/2 in.	75	165
2 in.	100	220
2 1/2 in.	125	275
3 in.	150	330
3 1/2 in.	175	385

\*The nominal maximum size of particles is defined as the largest sieve size listed in the applicable specifications upon which any material is permitted to be retained. Exception: If the specification tolerances are such that no sieve listed has a range of X-100 percent passing, then the next smallest standard sieve, as listed in Table I, and below that sieve which 100 percent must pass will be considered the nominal maximum size.

**TABLE II**  
**TEST PORTION FOR GRADATION**

<u>NOMINAL MAXIMUM SIZE OF PARTICLES</u>	<u>MINIMUM WEIGHT OF TEST PORTION</u>	
<u>Sieve Size</u>	<u>Kilo</u>	<u>lb</u>
No. 8	0.1	0.3
No. 4	0.5	1.0
3/8 in.	1.0	2.0
1/2 in.	2.0	4.0
3/4 in.	5.0	11.0
1 in.	10.0	22.0
1 1/2 in.	15.0	33.0
2 in.	20.0	44.0
2 1/2 in.	35.0	77.0
3 in.	60.0	130.0
3 1/2 in.	100.0	220.0

**ATTACHMENT I**

**RANDOM NUMBERS**

.858	.082	.886	.125	.263	.176	.551	.711	.355	.698
.576	.417	.242	.316	.960	.879	.444	.323	.331	.179
.587	.288	.835	.636	.596	.174	.866	.685	.066	.170
.068	.391	.139	.002	.159	.423	.629	.631	.979	.399
.140	.324	.215	.358	.663	.193	.215	.667	.627	.595
.574	.601	.623	.855	.339	.486	.065	.627	.458	.137
.966	.589	.751	.308	.025	.836	.200	.055	.510	.656
.608	.910	.944	.281	.539	.371	.217	.882	.324	.284
.215	.355	.645	.450	.719	.057	.287	.146	.135	.903
.761	.883	.711	.388	.928	.654	.815	.570	.539	.600
.869	.222	.115	.447	.658	.989	.921	.924	.560	.447
.562	.036	.302	.673	.911	.512	.972	.576	.838	.014
.481	.791	.454	.731	.770	.500	.980	.183	.385	.012
.599	.966	.356	.183	.797	.503	.180	.657	.077	.165
.464	.747	.299	.530	.675	.646	.385	.109	.780	.699
.675	.654	.221	.777	.172	.738	.324	.669	.079	.587
.269	.707	.372	.486	.340	.680	.928	.397	.337	.564
.338	.917	.942	.985	.838	.805	.278	.898	.906	.939
.130	.575	.195	.887	.142	.488	.316	.935	.403	.629
.011	.283	.762	.988	.102	.068	.902	.850	.569	.977
.683	.441	.572	.486	.732	.721	.275	.023	.088	.402
.493	.155	.530	.125	.841	.171	.794	.850	.797	.367
.059	.502	.963	.055	.128	.655	.043	.293	.792	.739
.996	.729	.370	.139	.306	.858	.183	.464	.457	.863
.240	.972	.495	.696	.350	.642	.188	.135	.470	.765

WEST VIRGINIA DEPARTMENT OF TRANSPORTATION  
DIVISION OF HIGHWAYS  
CONTRACT ADMINISTRATION DIVISION

MATERIALS PROCEDURE

---

PROCEDURE FOR EVALUATING QUALITY CONTROL SAMPLE TEST  
RESULTS WITH VERIFICATION SAMPLE TEST RESULTS

---

- 1.0 PURPOSE
- 1.1 To provide a procedure for the comparison of quality control sample test results with verification sample test results.
- 2.0 SCOPE
- 2.1 This procedure is primarily applicable to the contractor's test results when used in the acceptance process. Other tests, not necessarily applicable to the acceptance process but used for control of materials, may also apply.
- 2.2 Materials and Tests
  - 2.2.1 Aggregate Gradations
  - 2.2.2 Hot Mix Asphalt
    - 1. Asphalt Content
    - 2. Air Voids
    - 3. Stability
    - 4. Flow
  - 2.2.3 Portland Cement Concrete
    - 1. Air Content
    - 2. Consistency
- 3.0 PROCEDURE
- 3.1 The following procedure will be implemented by the District Materials Engineer/Supervisor.

- 3.2 Immediately after completion of the verification sample, it will be compared to applicable quality control sample test results for the same item. Note that all samples being compared must be taken from the same sampling location, e.g., stockpile, roadway, etc., and sampled and tested in the same manner. The comparison will be made in the following manner (also see sample computation sheets in the attachments).
- 3.2.1 If there are more than ten quality control samples available, determine the average of the ten consecutive quality control samples ( $\bar{X}_{10}$ ) whose midpoint is nearest chronologically to the verification sample. Should there only be five to ten quality control samples available, determine the average of all the available consecutive quality control test results. When comparing the grading characteristics of an aggregate, the average ( $\bar{X}$ ) for each sieve will be determined.
- 3.2.2 In the event there are less than five quality control samples available when the verification sample is complete, the District Materials Engineer/Supervisor will make an informal review of the data. If the data is such that a dissimilarity appears obvious (even without a formal comparison) then Section 4.1 of this procedure would apply. If, however, the verification sample results appear to be similar to the quality control sample results then the verification sample would be judged at this point by the District Materials Engineer/Supervisor to be similar, and the applicable portions of Section 5.1 of this procedure would apply with the following statement: "This verification sample (verification sample number recorded here) has been judged to be similar in accordance with Section 3.2.2 of MP 700.00.54."
- 3.2.3 Determine the range (R) of the quality control samples used in Section 3.2.1 by subtracting the smallest test value from the largest test value. When comparing the grading characteristics of aggregate, the range (R) for each sieve will be determined.
- 3.2.4 Compute the interval (I) by substituting the values calculated in Sections 3.2.1 and 3.2.3 into the proper equation below. When comparing the grading

characteristics of aggregate, the interval(I) for each sieve will be determined.

No. of Samples Used in Calculating the Average in Section 3.2.1	Equation for Computing the Interval (I)
10	$I = X(\bar{)}_{10} + 0.91R$
9	$I = X(\bar{)}_9 + 0.97R$
8	$I = X(\bar{)}_8 + 1.05R$
7	$I = X(\bar{)}_7 + 1.17R$
6	$I = X(\bar{)}_6 + 1.33R$
5	$I = X(\bar{)}_5 + 1.61R$

- 3.2.5 The interval(I) is determined by first adding the average ( $X(\bar{)}_n$ ) to the product of the range (R) times the given constant (This determines the upper limit of the interval). Note that for gradings, if the result obtained is greater than 100, it will be recorded as 100. And second, subtract the product of the range (R) times the given constant from the average ( $X(\bar{)}_n$ ). This determines the lower limit of the interval. Note here that if the result is less than zero, it will be recorded as zero.
- 3.2.6 Compare the verification sample test result with the calculated interval. When comparing the grading characteristics of aggregates, a comparison for each sieve will be determined.
- 3.3 If the verification sample is an aggregate and all sieve results coincide with or lie between the upper and lower limits of the interval, the quality control sample test results will be considered similar to the verification sample test results.
- 3.4 If the verification sample is an aggregate and any one of the compared values (on any sieve) is not similar to the quality control data, the quality control samples will be considered dissimilar to the verification sample.
- 3.5 If the verification sample is an asphalt mix, and the asphalt content and air voids coincide with or lie between the upper and lower limits of their interval,

the quality control samples will be considered to be similar to the verification sample.

3.6 If the verification sample is an asphalt mix, and any one of the compared values is not similar to the quality control data, the quality control samples will be considered to be dissimilar to the verification sample.

3.7 If the verification sample (test) is Portland Cement concrete, and both the air content and consistency coincide with or lie between the upper and lower limits of their interval, the quality control samples (tests) will be considered to be similar to the verification sample.

#### 4.0 EVALUATION

4.1 If the quality control sample data is dissimilar to the verification sample the following action will be taken where appropriate.

4.1.1 Review the quality control sampling procedure.

4.1.2 Review the quality control testing procedures.

4.1.3 Check testing equipment

4.1.4 Review computations.

4.1.5 Review documentation.

4.1.6 Perform any additional investigations that may clarify the dissimilarity.

#### 5.0 REPORTING

5.1 If the quality control samples are found to be similar to the verification sample, proof of the similarity will be shown on the back of, or attached to, the original verification sample test report. The proof will include all of the calculations specified in Section 3.2.1 through 3.2.6 using the format similar to that shown on the appropriate sample computation sheet (attached). The report should be signed by the District Materials Engineer/Supervisor and distributed as specified in Sections 5.5 and 5.6.



- 5.2 If the quality control samples are dissimilar to the verification sample, the investigation described in Section 4.0 will be documented on the reverse side, or attached to, the original verification sample test report as described below, omitting the words in parenthesis which do not apply. A copy of all calculations specified in Section 3.2.1 to 3.2.6 using the format similar to that shown on the appropriate sample computation sheet will also accompany the test report.
1. Quality control sampling procedures (are, are not) in accordance with applicable directives.
  2. Quality control testing procedures (are, are not) in accordance with applicable directives.
  3. Testing equipment (is, is not) in proper working order.
  4. Computations (are, are not) correctly performed.
  5. Documentation (is, is not) properly performed.
  6. Report any other information that may have been determined in accordance with Section 4.1.6.
- 5.3 All negative replies noted above will be explained. This will include a brief statement of the action taken to correct the deficiency. In the event other documentation is needed, such as a District Materials Inspection Report, to explain and/or support the final resolution of the dissimilarity, the dissimilar verification sample number should be referenced therein.
- 5.4 Results of the investigation as reported will be signed by the District Materials Engineer/Supervisor.
- 5.5 On the test report at the bottom will be typed the following: "Issued by District (Number) per MP 700.00.54, (Date)."
- 5.6 The signed, issued report should be prepared in duplicate and distributed as follows:

MP 700.00.54  
REPLACES ML27 AND ML31  
ISSUED: JULY 1991  
REISSUED: JANUARY 1995  
1ST REVISION: JULY 2000  
PAGE 6 OF 6

---

5.6.1 The original copy will be submitted to the Contract Administration Division, Materials Section.

5.6.2 On copy should be maintained in the District Materials file.

---

  
Robert K. Tinney, Director  
Contract Administration Division

RKT:bk

ATTACHMENTS

MP 700.00.54  
 REPLACES ML27 AND ML31  
 ISSUED: JULY 1991  
 REISSUED: JANUARY 1995  
 1ST REVISION: JULY 2000  
 ATTACHMENT NO. 1

**COMPUTATION SAMPLE SHEET  
 ASPHALT**

Quality Control Lab. Number	Date	Asphalt Content (%)	Air Voids (%)	Stability Newtons)	Flow (0.25mm)
C7-68439	9-15-98	3.8	3.7	9586	11.3
C7-68676	9-16-98	4.3	3.2	9512	9.8
C7-68922	9-16-98	3.5	4.1	9688	10.6
C7-69314	9-17-98	4.0	4.4	9450	11.5
C7-69658	9-17-98	4.2	3.8	9498	10.2
C7-69770	9-18-98	4.0	5.0	9725	9.1
C7-69879	9-22-98	4.0	4.6	9531	10.3
C7-69891	9-22-98	4.0	3.7	9706	11.1
C7-70126	9-23-98	4.5	3.0	9825	11.6
C7-70245	9-24-98	4.3	4.6	9412	10.8

X(bar) = 4.06 4.01 9593.3 10.63

Property	Average X(bar) <sub>10</sub>	Constant ± (0.91)	Range x (R)	Interval (I)	V.S. <sup>1</sup> Result	Similar Yes/No
Asphalt Content	4.06	0.91	1.0	5.0/3.2 <sup>2</sup>	4.5	Yes
Air Voids	4.01	0.91	3.0	6.7/1.3 <sup>2</sup>	3.9	Yes
Flow	10.63	0.91	2.5	12.9/8.4 <sup>2</sup>	10.3	Yes
Stability	9593.3	0.91	413	9969/9217 <sup>3</sup>	9650	Yes

Note: All four of these tests may not apply to any one sample. For those tests that do apply and all replies in the "Similar" column are "Yes", take action specified in Section 5.1. If one or more of the applicable test replies in the "Similar" column are "No", take action specified in Section 5.2.

- 1 - Verification Sample.
- 2 - Round calculated intervals to nearest 0.1 percent.
- 3 - Round calculated interval to nearest whole Newton.

MP 700.00.54  
 REPLACES ML27 AND ML31  
 ISSUED: JULY 1991  
 REISSUED: JANUARY 1995  
 1ST REVISION: JULY 2000  
 ATTACHMENT NO. 2

**COMPUTATION SAMPLE SHEET  
 PORTLAND CEMENT CONCRETE**

Quality Control ID or Lab. Number	Date	Air Content (%)	Consistency (Slump) (inches)
01	9-15-98	6.2	2.50
02	9-16-98	7.0	2.75
03	9-16-98	5.2	2.50
04	9-17-98	6.4	3.00
05	9-17-98	5.0	2.75
06	9-18-98	5.8	2.25
07	9-22-98	5.4	2.50
08	9-22-98	4.4	2.75
09	9-23-98	6.0	3.00
10	9-24-98	6.0	2.50

X(bar) = 5.74 2.65

Property	Average X(bar) <sub>10</sub> ±	Constant (0.91)	Range (R)	Interval (I)	V.S. <sup>1</sup> Result	Similar Yes/No
Air Content	5.74	0.91	2.6	8.1/3.4 <sup>2</sup>	7.6	Yes
Consistency (Slump)	2.65	0.91	0.75	3.25/2.00 <sup>3</sup>	3.00	Yes

Note: If all replies in the "Similar" column are "Yes", take action Specified in Section 5.1. If one or both of the replies in the "Similar" column are "No", take action specified in Section 5.2.

- 1 - Verification Sample
- 2 - Round calculated interval to nearest 0.1 percent.
- 3 - Round calculated interval to nearest 0.25 inches.

MP 700.00.54  
 REPLACES ML27 AND ML31  
 ISSUED: JULY 1991  
 REISSUED: JANUARY 1995  
 1ST REVISION: JULY 2000  
 ATTACHMENT NO. 3

**COMPUTATION SAMPLE SHEET  
 AGGREGATE GRADATIONS**

Quality Control							
Lab. Number	Date	1 ½"	1"	½"	#4	#8	#200
C7-57698	08-10-98	100	100	25	4	2	0.6
C7-57972	08-10-98	100	100	30	2	2	0.6
C7-58793	08-11-98	100	99	28	2	1	0.4
C7-58845	08-11-98	100	99	49	8	2	1.0
C7-76068	08-12-98	100	100	32	2	1	0.5
C7-76271	08-12-98	100	100	36	1	1	0.6
C7-78174	08-13-98	100	100	42	2	2	0.7
C7-78232	08-13-98	100	100	19	1	1	0.5
C7-78496	08-14-98	100	100	36	2	2	0.3
C7-78541	08-15-98	100	100	43	1	1	0.5

X(bar) = 100 99.8 34.0 2.5 1.5 0.57

Sieve Size	Average X(bar) <sub>10</sub> ±	Constant (0.91)	Range x (R)	Interval (I)	V.S.* Result	Similar Yes/No
1 ½"	100	0.91	0	100/100	100	Yes
1"	99.8	0.91	1	100/99	100	Yes
½"	34.0	0.91	30	61/7	24	Yes
#4	2.5	0.91	7	9/0	2	Yes
#8	1.5	0.91	1	2/0	1	Yes
#200	0.57	0.91	0.7	1.2/0	0.4	Yes

Note: If all replies in the "Similar" column are "Yes", take action Specified in Section 5.1. If one or more of the replies in this column are "No", take action specified in Section 5.2.

All calculated intervals are to be rounded to the nearest whole number except the #200 sieve which is rounded to the nearest 0.1.

\* Verification Sample

WEST VIRGINIA DEPARTMENT OF TRANSPORTATION  
DIVISION OF HIGHWAYS  
MATERIALS CONTROL, SOILS AND TESTING DIVISION

MATERIALS PROCEDURE

---

STANDARD METHOD OF TEST FOR PERCENT CRUSHED PARTICLES

---

**1. PURPOSE**

- 1.1 To set forth a standard method of test for determining the percent of crushed particles in coarse aggregate.
- 

**2. SCOPE**

- 2.1 This method of test is applicable to that portion of crushed aggregate which is retained on the 4.75 mm (No. 4) sieve when that material is being used for applications where the standard specifications places a requirement on the percent of crushed particles.
- 

**3. EQUIPMENT**

- 3.1 *Balance*—The balance shall have sufficient capacity, be readable to 0.1 percent of the sample mass, or better, and conform to the requirements of ASSHTO M 231.
- 3.2 *Oven*—An oven capable of maintaining a temperature of 230°F ± 9°F (110°C ± 5°C).
- 3.3 *Sieve*—4.75 mm (No. 4), conforming to AASHTO M 92
- 3.4 *Pans*—Large flat pans for spreading the aggregate in a single layer, and suitable for containing the pieces of aggregate as they are separated.
- 3.5 *AASHTO Compliant Splitter* – Compliant with AASHTO M 92
- 

**4. DEFINITIONS**

- 4.1 Crushed Particle - A particle of aggregate which has at least one face fracture as defined in Section 4.1.1.
- 4.1.1 Face Fracture - A face fracture is defined as a break that has resulted from the production process (crushing operation) which constitutes an area of at least 25 % of the largest two-dimensional area of the particle.
- 4.1.2 Single Face Fracture - A particle which has only one exposed break in a single plane meeting the requirements set forth in Section 4.1.1. An example of a single face fracture is shown in Figure 1.

FIGURE 1

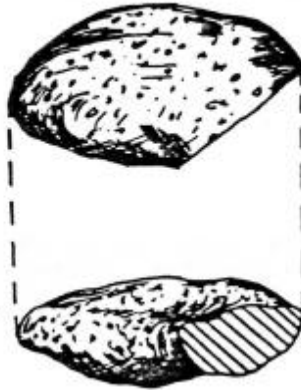

- 4.1.3 Multi-Face or Two Face Fracture - A particle which has at least two exposed breaks in two or more planes meeting the requirements set forth in Section 4.1.1. An example of a multi-face fracture is shown in Figure 2.

FIGURE 2

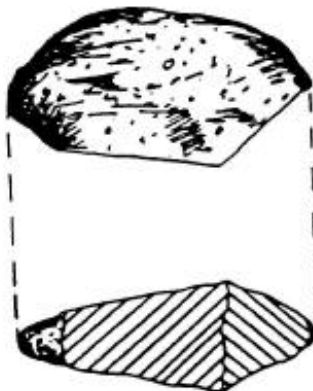

---

## 5. TEST PORTION PREPARATION

- 5.1 Obtain enough aggregate from the field sample to yield a test portion of the appropriate size by use of a sample splitter. (*see NOTE*)
- 5.2 Sieve the aggregate over a 4.75 mm (No. 4) sieve and discard the minus 4.75 mm (No. 4) material.
- 5.3 Gently wash the aggregate retained on the 4.75 mm (No. 4) sieve to remove any dust or coatings.
- 5.4 Dry the clean, sieved aggregate to a constant mass in an oven maintained at 230°F ± 9°F (110°C ± 5°C).

*NOTE:* Approximate mass of the test portion of crushed aggregate after sieving.

NOMINAL MAXIMUM SIZE OF PARTICLES	MINIMUM MASS OF TEST PORTION
9.5 mm (3/8-in.)	500 g
19 mm (3/4-in.)	1500 g
37.5 mm (1-1/2-in.)	3000 g
Over 37.5 mm (1-1/2-in.+)	5000 g

---

**6. TEST PROCEDURE**

- 6.1 Weigh the test portion and record the mass to the nearest gram on the WVDOH Form T 302 (see attached sample form). The live form is available on the WVDOH MCS&T [Webpage Toolbox](#).<sup>1</sup> See NOTE in Section 5. for the required test portion mass.
- 6.2 Place the test portion in a large, flat pan or on another suitable workspace. Arrange and label three pans for separating the test portion into single-face, multi-face, and no-face fractures.
- 6.3 Pick up and inspect each particle to determine the number of face fractures and place them in the appropriate pan or container.
- 6.4 After the entire test portion has been separated, weigh each fraction and record the masses on the T302 form to the nearest whole gram.
- 6.5 The entire test portion is to be re-combined and the test is to be conducted by a second technician. The second technician is to follow the steps described in Sections 6.1 through 6.4.
- 6.6 Use form T302 for comparison of the two Technician's results. When the results obtained by two technicians vary more than two percent, it is necessary for both technicians to review the test procedure and re-conduct the test, beginning at Section 6.1.

---

<sup>1</sup> <https://transportation.wv.gov/highways/mcst/Pages/tbox.aspx>



---

**7. CALCULATIONS**

7.1 Let  $M_2$  = the mass of all particles which have two or more face fractures.

$M_1$  = the mass of all particles which have only one fractured face.

$M_0$  = the mass of all particles which have no fractured faces.

$M_3 = M_1 + M_2$  = Total mass of crushed particles (Single-Face or more)

$M_4$  = Total test portion mass

7.2 Total Percent Crushed Particles (Single-Face or more) =

$$(M_3 / M_4) \times 100$$

7.3 Percent Multi-face Fractures =

$$(M_2 / M_4) \times 100$$

7.4 When the final two results have been obtained, they shall be averaged, and the average reported is to be to the nearest 1.0%.

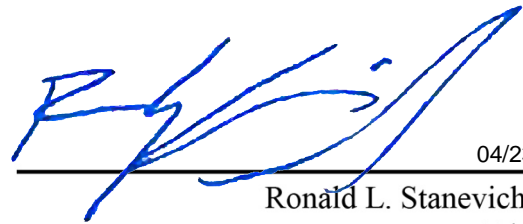

04/23/2020

Ronald L. Stanevich, P.E.  
Director

Materials Control, Soils and Testing Division

RLS: Ms

Attachment

WEST VIRGINIA DIVISION OF HIGHWAYS  
MATERIALS SECTION  
FACE FRACTURE  
MP 703.00.21

Lab Location: _____	Producer/Supplier Name: _____
Lab Reference Number: _____	Producer/Supplier Code: _____
Date Sampled: _____	Material Code: _____
Contract ID: _____	Project Number: _____

Technician 1: \_\_\_\_\_ Technician 2: \_\_\_\_\_

Source \_\_\_\_\_ Date \_\_\_\_\_ Field Sample # \_\_\_\_\_

Technician 1:	Initial Mass _____	Mass (Nearest 1g)	Percent of Sample (Nearest 0.1%)
	0 Face _____	_____	_____
	1 Face _____	_____	_____
	2 or More Face _____	_____	_____
	Final Mass _____	_____	_____
	Total Crushed Particles _____	_____	_____

Technician 2:	Initial Mass _____	Mass (Nearest 1g)	Percent of Sample (Nearest 0.1%)
	0 Face _____	_____	_____
	1 Face _____	_____	_____
	2 or More Face _____	_____	_____
	Final Mass _____	_____	_____
	Total Crushed Particles _____	_____	_____

Final Results

	Tech 1	Tech 2	Difference (Must be less than 2%)	Average to Nearest 1%
0 Face	_____	_____	_____	_____
1 Face	_____	_____	_____	_____
2 or More Face	_____	_____	_____	_____
Total Crushed Particles	_____	_____	_____	_____

**WEST VIRGINIA DIVISION OF HIGHWAYS**  
SIEVE ANALYSIS OF FINE AND COARSE AGGREGATE (AASHTO T-27)  
MATERIALS FINER THAN NO. 200 SIEVE BY WASHING (AASHTO T-11)

Site Manager I.D.# or AASHTOWare Project I.D.#:  Lab Reference Number: Technician: Producer / Supplier Code: Producer / Supplier Name: Site Manager Material Code: Date Sampled: Date Tested:	Aggregate Size:      Combo User Input Sieve Type Coarse:      12 Inch Sieve Type Fine:      12 Inch Material Type:      Lime Stone	Spec Sieve Sizes    % Pass    Pass /Fail _____ _____ _____ _____ _____ _____ _____ _____ _____ _____
Contract #: Project #: Auth #: Item #: Tons / CY		

- (A) Initial Oven Dry Mass of Total Sample..... (A) \_\_\_\_\_
- (B) Oven Dry mass of Total Sample After T-11..... (B) \_\_\_\_\_
- (C) Oven Dry Mass of Plus No. 4 Material..... (C) \_\_\_\_\_
- (D) Oven Dry Mass of Plus No. 4 Material After T-11..... (D) \_\_\_\_\_
- (E) Oven Dry Mass of Minus No. 4 Material Used in Split..... (E) \_\_\_\_\_
- (F) Combination Gradation Coarse Fraction Pan Material After Dry Sieving (K)..... (F) \_\_\_\_\_
- (G) Total Oven Dry Mass of Minus No. 4 Material (E+F)..... (G) \_\_\_\_\_
- (H) Initial Oven Dry Mass of Total Fine Sample or Mass of Minus No. 4 Material..... (H) \_\_\_\_\_
- (I) Oven Dry Mass of Total Fine Sample or Mass of Minus No. 4 Material After T-11..... (I) \_\_\_\_\_

**Sieve Analysis of Coarse Aggregate**

Sieve Size	Mass Retained M <sub>R</sub>		Over Loading	% Retained (M <sub>R</sub> /A)x100	Percent Passing	Reported Percent Passing	Material Specifications	
	Regular	Combination					Low	High
(J) Pan .....								
(K) Combination Grad. Pan .....								
(L) Loss By T-11.....								
(M) Final Total (Σ M <sub>R</sub> )								

C. F. =   (G)   ÷   (P)    
 C. F. = \_\_\_\_\_ ÷ \_\_\_\_\_  
 C. F. = \_\_\_\_\_

**Sieve Analysis of Fine Aggregate**

Sieve Size	Mass Retained M <sub>R</sub>		Over Loading	% Retained (M <sub>R</sub> /(HorA) x100	Percent Passing	Reported Percent Passing	Material Specifications	
	Regular	Combination					Low	High
(N) Pan.....								
(O) Loss By T-11.....								
(P) Final Total Fine Sample (Σ M <sub>R</sub> ).....								
(Q) Final Total - No. 4 (Σ M <sub>R</sub> ).....								
(R) Combined Total (M+Q).....								
(S) Sample Loss or Gain	(A-M) or (M-A).....							
	(H-P) or (P-H).....							
	(A-R) or (R-A).....							
(T) Percentage of Initial OD Mass ((S/A)x100) or ((S/H)x100)								

Name: \_\_\_\_\_  
 Signature: \_\_\_\_\_  
 Date: \_\_\_\_\_

Remarks:	<b>Pass/Fail</b>	Lab Info Only: <input type="checkbox"/>	

WEST VIRGINIA DIVISION OF HIGHWAYS  
MATERIALS CONTROL SOILS & TESTING DIVISION  
FACE FRACTURE  
MP 703.00.21

Lab Number		Project and Contract					Date Sampled			Transmit Date
Test Sequence	Material Code	C					Item Number	Plant Source Code	Aggregate Source Code	
		Quantity								
Sieves:	1st	2nd	3rd	4th	5th	6th	7th	8th	No. 200	
Design Number	Bitumen Content		Unit Weight		Face Fracture		LL	PL	PI	
	Target	Actual	Weight	%One	%Two					
AASHTO Size	Smallest Sieve 100%	Target A-bar	Actual A-bar	FA A-bar	CA No. 200	FA No. 200	Total No. 200	P/F/N		

Technician 1: \_\_\_\_\_ Technician 2: \_\_\_\_\_

Source \_\_\_\_\_ Date \_\_\_\_\_ Field Sample # \_\_\_\_\_

Technician 1.	Initial Mass (Nearest 1g)	Mass (Nearest 1g)	Percent of Sample (Nearest 0.1 %)
	_____	_____	_____
	0 Face	_____	_____
	1 Face	_____	_____
	2 or More Face	_____	_____
	Final Mass	_____	_____
	Total Crushed Particles	_____	_____
Technician 2.	Initial Mass	Mass (Nearest 1g)	Percent of Sample (Nearest 0.1 %)
	_____	_____	_____
	0 Face	_____	_____
	1 Face	_____	_____
	2 or More Face	_____	_____
	Final Mass	_____	_____
	Total Crushed Particles	_____	_____

Final Results	Tech 1	Tech 2	Difference (Must be 2% or less)	Average Results to Nearest 1 %
0 Face	_____	_____	_____	_____
1 Face	_____	_____	_____	_____
2 or More Face	_____	_____	_____	_____
Total Crushed Particles	_____	_____	_____	_____

T303E

WEST VIRGINIA DIVISION OF HIGHWAYS

Rev. 1-05

MATERIALS CONTROL SOILS AND TESTING DIVISION

UNIT WEIGHT OF AGGREGATE AASHTO T 19

CALIBRATION OF UNIT WEIGHT MEASURE

DATE \_\_\_\_\_

CALIBRATED BY \_\_\_\_\_

MEASURE SIZE \_\_\_\_\_

A. Weight of Measure, Glass, Grease, and Water \_\_\_\_\_

B. Weight of Measure, Glass, and Grease \_\_\_\_\_

C. Weight of Water in Measure \_\_\_\_\_

D. Convert g to lb. if necessary \_\_\_\_\_

E. Temperature of Water (Nearest 0.2°F or 0.1°C) \_\_\_\_\_

F. Weight of Water at Temperature E (from Tables in Aggregate Manual  
Chap. 5, AASHTO T19) \_\_\_\_\_

G. Factor for Measure (Round to nearest thousandth) \_\_\_\_\_

All Weightes rounded to the nearest 0.1 lb. or 50 g (0.05 kg)

$C = A - B$

$D = C \div 453.6$  (If C measured in g)

$D = C$  (If C measured in lb.)

$G = F \div D$

UNIT WEIGHT OF AGGREGATE

Lab Number		Project and Contract					Date Sampled			Transmit Date	
Test Sequence	Material Code		C			Quantity	Item Number		Plant Source Code		Aggregate Source Code
	1st	2nd	3rd	4th	5th		6th	7th	8th	No. 200	
Sieves:	1st	2nd	3rd	4th	5th	6th	7th	8th	No. 200		
Design Number	Bitumen Content		Unit Weight		Face Fracture		%One	LL	PL	PI	
	Target	Actual					%Two				
AASHTO Size	Smallest Sieve 100%	Target A-bar	Actual A-bar	FA A-bar	CA No. 200	FA No. 200	Total No. 200			P/F/N	

Technician \_\_\_\_\_

Rodded \_\_\_\_\_ Loose \_\_\_\_\_ Jigged \_\_\_\_\_

Source \_\_\_\_\_

Date \_\_\_\_\_ Field Sample # \_\_\_\_\_

1st Trial

2nd Trial

A. Weight of Measure and Aggregate

\_\_\_\_\_

\_\_\_\_\_

B. Weight of Measure

\_\_\_\_\_

\_\_\_\_\_

C. Weight of Aggregate

\_\_\_\_\_

\_\_\_\_\_

D. Convert Weight of Aggregate from g to lb. if necessary

\_\_\_\_\_

\_\_\_\_\_

E. Correction Factor of Measure (Report to the nearest lb./ft.<sup>3</sup>)

\_\_\_\_\_

\_\_\_\_\_

F. Weight per Cubic Foot (Reported to nearest lb./ft.<sup>3</sup>)

\_\_\_\_\_

\_\_\_\_\_

G. Average Weight per Cubic Foot (Report to the nearest lb./ft.<sup>3</sup>)

\_\_\_\_\_

H. Average Tons/yd.<sup>3</sup> (Reported to nearest 0.01 Tons/yd.<sup>3</sup>)

\_\_\_\_\_

All weights measured to the nearest 0.1 lb or 50 g (0.05 kg).

$C = A - B$

$D = C \div 453.6g$  (if C is measured in g)

$F = D \times E$

$H = G \times 27 \div 2000$

BULK SPECIFIC GRAVITY AND ABSORPTION  
FINE AGGREGATE

Laboratory No.	
Field Sample No.	
Date	
Source	
Tested By	

(Record masses to 0.1 g)

A = Mass of oven-dry sample in air, grams ((a)-(b)) \_\_\_\_\_

(a) Mass of oven-dry sample and drying pan in air, grams \_\_\_\_\_

(b) Mass of drying pan, grams \_\_\_\_\_

B = Mass of pycnometer filled to calibration mark with distilled water, grams \_\_\_\_\_

C = Mass of pycnometer, sample, and water to calibration mark, grams \_\_\_\_\_

D = Mass of saturated-surface-dry sample in air, grams \_\_\_\_\_

Bulk Specific Gravity (Oven Dry Basis) =  $\frac{A}{B+D-C}$  = \_\_\_\_\_

Bulk Specific Gravity (Saturated-Surface-Dry Basis) =  $\frac{D}{B+D-C}$  = \_\_\_\_\_

Apparent Specific Gravity =  $\frac{A}{B+A-C}$  = \_\_\_\_\_

Absorption, percent =  $\frac{D-A}{A} \times 100$  = \_\_\_\_\_

**Report Specific Gravities to the nearest 0.01**  
**Report Absorption to the nearest 0.1%**

T306  
Rev. 9-22

WEST VIRGINIA DIVISION OF HIGHWAYS  
MATERIALS CONTROL SOILS & TESTING DIVISION

BULK SPECIFIC GRAVITY AND ABSORPTION  
COARSE AGGREGATE

Laboratory No.	
Field Sample No.	
Date	
Source	
Tested By	

(Record masses to 1 g)

A = Mass of oven-dry sample in air, grams	
B = Mass of saturated-surface-dry sample in air, grams	
C = Mass of saturated sample in water, grams	

Bulk Specific Gravity (Oven Dry Basis) =  $\frac{A}{B-C}$  = \_\_\_\_\_

Bulk Specific Gravity (Saturated-Surface-Dry Basis) =  $\frac{B}{B-C}$  = \_\_\_\_\_

Apparent Specific Gravity =  $\frac{A}{A-C}$  = \_\_\_\_\_

Absorption, percent =  $\frac{B-A}{A} \times 100$  = \_\_\_\_\_

Report Specific Gravities to the nearest 0.01  
Report Absorption to the nearest 0.1%



LIQUID / PLASTIC LIMIT AND PLASTICITY INDEX

Lab Number		Project and Contract					Date Sampled			Transmit Date
Test Sequence	Material Code		C			Item Number	Plant Source Code		Aggregate Source Code	
	1st	2nd	3rd	4th	5th		6th	7th		8th
Sieves:	1st	2nd	3rd	4th	5th	6th	7th	8th	No. 200	
Design Number	Bitumen Content		Unit		Face Fracture		LL	PL	PI	
			Target	Actual	Weight	%One	%Two			
								0	0	0
AASHTO Size	Smallest Sieve 100%	Target A-bar	Actual A-bar	FA A-bar	CA No. 200	FA No. 200	Total No. 200			P/F/N

Technician \_\_\_\_\_ Date \_\_\_\_\_ Field Sample # \_\_\_\_\_

Source \_\_\_\_\_

**Report all masses to nearest 0.01 g.  
Calculate % of Water to nearest 0.1%.**

LIQUID LIMIT

		A	B	C	D	E	F	G
Dish No.	No. of Blows	Mass of Dish & Wet Soil	Mass of Dish & Dry Soil	Mass of Dish	Mass of Water	Mass of Dry Soil	% of Water	Liquid Limit

PLASTIC LIMIT AND PLASTICITY INDEX

	H	K	L	M	N	P	R	S
Dish No.	Mass of Dish & Wet Soil	Mass of Dish & Dry Soil	Mass of Dish	Mass of Water	Mass of Dry Soil	% of Water	Plastic Limit	Plasticity Index

Liquid Limit

D = A - B

E = B - C

F = (D / E) X 100

G = VALUE FROM FLOW CURVE (Nearest Whole No.) (3 pt. method)

G = F X (CORR. FACTOR) (Nearest Whole No.) (1 pt. method)

Plasticity Index

S = G - R

Plastic Limit

M = H - K

N = K - L

P = (M / N) X 100

R = P (Nearest Whole No.)

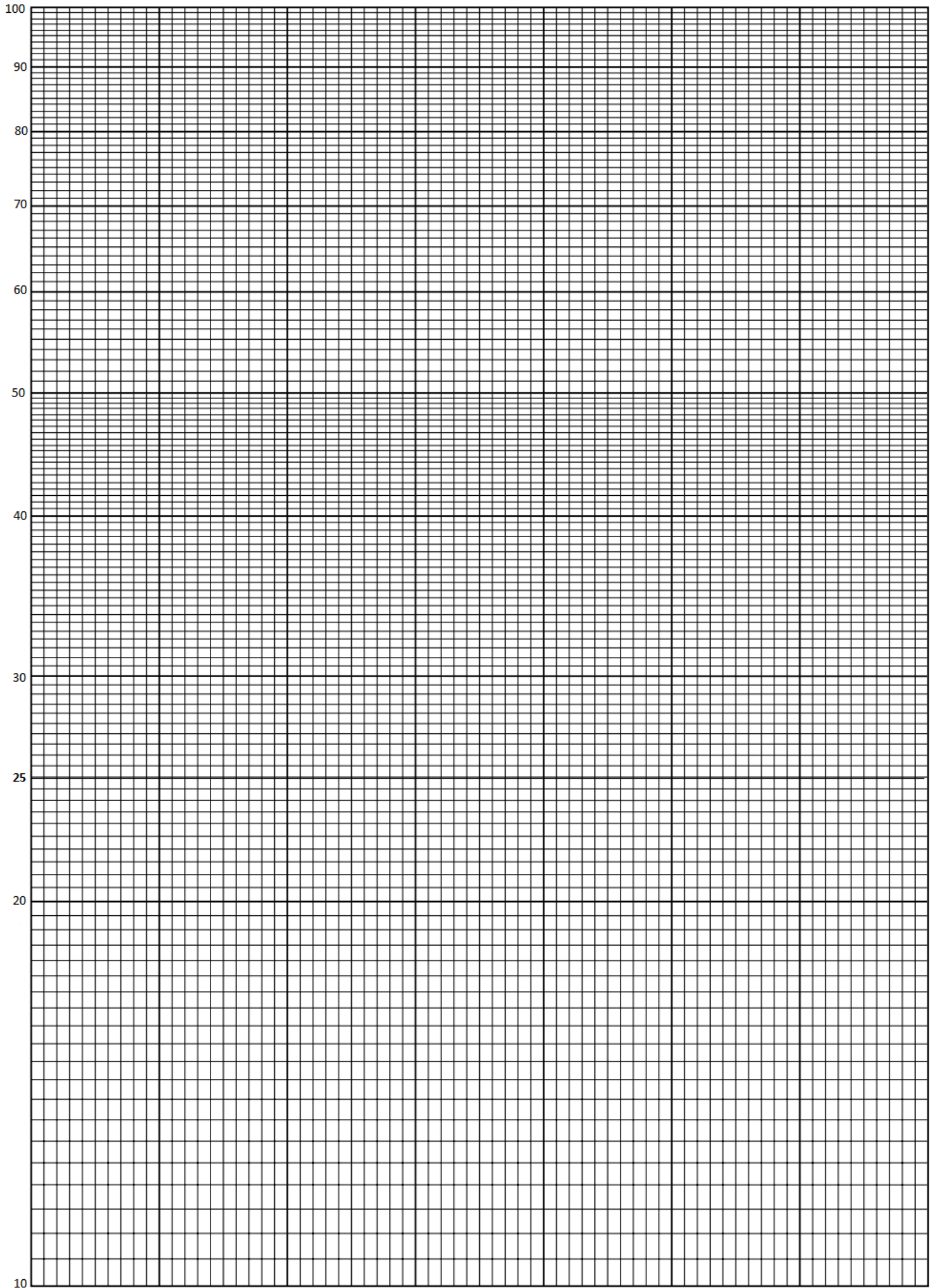

T100  
REV. 1-97

**WEST VIRGINIA DIVISION OF HIGHWAYS**  
**TEST SAMPLE DATA**

Laboratory Number	_____	Source Code	_____
Material Description	_____	Source	_____
Materials Code	_____	Item No. 1	_____
Date Received	_____	Item No. 2	_____
Project ALP	_____	Quantity	_____
Project/Auth. Number	_____	Unit	_____
Date Sampled	_____	Station	_____
Sampled By	_____	Elevation	_____
Field Sample Number	_____	Offset	_____
Bridge Number	_____	CS Tag Number	_____
Test Required	_____		

Other Identification \_\_\_\_\_  
\_\_\_\_\_  
\_\_\_\_\_

REMARKS:

**EXCERPTS FROM  
WEST VIRGINIA DIVISION OF HIGHWAYS  
CONSTRUCTION MANUAL  
DIVISION 700, MATERIALS CONTROL**

Required Samples and Tests

703(3)

MATERIAL	SAMPLE LOCATION	MINIMUM FREQUENCY	SAMPLE SIZE	SAMPLE TESTING	REMARKS
<b>AGGREGATES (Quality Check)</b>					
Commercial Sources	At Source (Sampled by MCS&T Division)	Sampled and tested annually.	75 – 125 lbs (35 – 60 kg)	Tests conducted by MCS&T Division (See Note 4).	For sampling method, see MP 700.00.06.
	At Intermediate or Final Destination (Sampled by field personnel.)	One sample per each 10,000 tons (10 000 Mg) or 5,000 yd <sub>3</sub> (4 000 m <sub>3</sub> ) of material used for project(s).	Refer to MP 700.00.06.	Tests conducted by field personnel. (See Note 3)	For sampling method, see MP 700.00.06.
Local Sources	At Production or Storage Site (Sampled by field personnel.)	One sample per each six days of production.	Refer to MP 700.00.06.	Tests conducted by MCS&T Division. (See Note 4)	For sampling method, see MP 700.00.06.
	At Production or Storage Site (Sampled by field personnel.)	One sample per each six days of production.	Refer to MP 700.00.06.	Tests conducted by field personnel. (See Note 3)	For sampling method, see MP 700.00.06.
<b>AGGREGATES (Gradation Check)</b>					
Base Course, Subbase and, Shoulders	Typically sampled from the roadway prior to compaction. (See Note 9)	One sample per each half day of operation or as specified in the Contractor's approved Quality Control Plan.	Refer MP 700.00.06.to	Gradation (See Note 1)	Refer to MP 700.00.06.
Portland Cement Concrete	See Remarks.	One sample per each day of operation.	Refer to MP 700.00.06.	Gradation and Total Solids (See Note 1)	Refer to MP 700.00.06 and MP 601.03.51
Misc. Items (bedding, backfill around pipe culverts, underdrains etc.)	Project Stockpile or Production Site	One sample per each half-day of operation or stockpiling.	Refer to MP 700.00.06.	Gradation(See Note 1)	Refer to MP 700.00.06.
Misc. Items (subgrade, select material for backfilling)	Project Stockpile or Production Site	One sample per each day of production or shipment unless otherwise specified.	Refer to MP 700.00.06.	Gradation (See Note 1)	Refer to MP 700.00.06.

**MINIMUM SAMPLING AND TESTING CRITERIA  
Figure 703A**

703(4)

Required Samples and Tests

MATERIAL	SAMPLE LOCATION	MINIMUM FREQUENCY	SAMPLE SIZE	SAMPLE TESTING	REMARKS
<b>AGGREGATES (Density and Thickness Check)</b>					
Base Course and Subbase	Roadway	DENSITY One sample per each working-width layer per 2,000 ft (600 m) (lot size).	As required by governing test procedures.	Conformity with 80% to specified target percent of dry density.	Divide the "lot" into five approximately equal size sublots and randomize location of density tests.
		THICKNESS: One sample per each working-width layer per 1,200 ft (350 m).	As required by governing test procedures.	(See Note 1)	Measure after all fine grading operations are completed and randomize location of thickness tests.

**Notes:**

1. Refer to the governing section of the contract documents.
2. Unless otherwise specified, take samples at the point of delivery if the material has not been previously sampled and tested by the WVDOT Materials Control, Soils and Testing Division. Certain material sources consistently demonstrate an ability to supply acceptable products. WVDOT periodically samples and tests products from selected material sources and, if acceptable, will designate the source as approved and certified. Contact the Materials Control, Soils and Testing Division for an updated list of approved and certified material sources (e.g., mills, terminals). Unless otherwise specified, if the Contractor provides sufficient documentation to substantiate that a material has been supplied by an approved and certified source, accept the material for use upon delivery to the project site (i.e., no further sampling and testing is required). Otherwise, further sampling and testing may be required. The Project Office should maintain an up-to-date list of all approved and certified material sources that are applicable to the project.
3. Conduct all tests required by the contract documents except for the following: Los Angeles Abrasion (LA), soundness, mortar strength, organic impurities, and deleterious content (analysis optional). The tests may include, but will not be limited to, the following: Atterberg Limits (liquid limit, plastic limit, and plasticity index), percent crushed particles (single-face and multiple-face fracture), unit weight, and others as specified.
4. The WVDOT Materials Control, Soils and Testing Division will test for the following: Los Angeles Abrasion (LA), soundness, deleterious content, mortar strength, and organic impurities.
5. Unless the shipment is certified or pre-tested, take one asphalt sample per shipment at its point of delivery. An asphalt shipment is considered certified if it is shipped from a WVDOT approved and certified material source. Contact the Project Office or Materials Control, Soils and Testing Division for an updated list of approved and certified material sources. A shipping document will accompany each pre-tested asphalt shipment. A laboratory number will appear on the shipping document from which the asphalt material's test results can be obtained. As needed, use this laboratory number to confirm the acceptability of the material.

**MINIMUM SAMPLING AND TESTING CRITERIA**

**(Continued)  
Figure 703A**

6. The following procedures apply to all quantities of Portland cement concrete from A1 plants and all quantities of miscellaneous concrete, as defined by IM 18, from A2 plants. If sufficient plant production exists, the WVDOT Materials Control, Soils and Testing Division will obtain a minimum of ten randomly selected samples from plant production and test for compressive strength, air content, and consistency. Yield will be determined from one of the ten samples. For a minimum of four of these samples, the batching operation at the plant will be observed to check operational control and to obtain aggregate samples for gradation testing. If plant production is insufficient to fulfill these requirements, however, the Materials Control, Soils and Testing Division will obtain one sample per two days of operation, minimum, and test for compressive strength, air content, and consistency. One yield test will be conducted for every ten samples. For a minimum of 40% of the samples, but no more than four times per month, the batching operation at the plant will be observed to check operational control and to obtain aggregate samples for gradation testing. For testing in either A1 or A2 plants, project personnel may substitute observations of the Contractor's quality control tests in lieu of the testing normally required by Figure 703A, except that occasional testing may be performed on the project to monitor the Contractor's program. In the event that the Contractor's quality control testing does not provide sufficient data to meet the requirements of Figure 703A, additional testing will be performed by the Division to complete the minimum frequency required.
7. The sampling frequency and tests for structural concrete also apply to Portland cement concrete pavement, where coring is considered impractical, and to all structural items constructed with pavement concrete (e.g., approach slabs), if authorized in the contract specifications.
8. Do not accept material delivered to the job site unless the shipment has a corresponding WVDOT approval number. In such cases, contact the WVDOT Materials Control, Soils and Testing Division for resolution or disposition. Refer to the "Evidence of Inspection List," which is updated annually and available in each District office, for the contact person within the Materials Control, Soils and Testing Division and the material's required acceptance criteria.
9. Unless specified otherwise, the Project Engineer may approve sampling at an alternate point if the following conditions are met: a) The material is taken from a conveyor belt or pug mill and hauled directly to and incorporated into the job with samples taken from the conveyor belt or pug mill discharge; b) The sampling procedure is in accordance with MP 700.00.06; and c) Sufficient data is developed to assure that the test results of samples taken from the alternate point do not differ significantly from the test results of samples taken from the roadway.

**MINIMUM SAMPLING AND TESTING CRITERIA**  
**(Continued)**  
**Figure 703A**







