



ACCESSIBLE RIGHTS-OF-WAY:
SIDEWALKS • STREET CROSSINGS • OTHER PEDESTRIAN FACILITIES

A DESIGN GUIDE

November 1999

A publication of the U.S. Architectural and Transportation Barriers Compliance Board
(The Access Board)

TABLE OF CONTENTS

Introduction_____6

Part I: Regulatory Requirements for Accessible Public Rights-of-Way

Chapter 1: Overview of the Americans with Disabilities Act_____11

- 1.1 Title II of the ADA:
State and Local Government Services_____12
- 1.2 ADA Implementing Regulations _____12
 - 1.2.1 The Preamble _____13
 - 1.2.2 The Rule _____13
 - 1.2.3 Accessibility Standards for New
Construction and Alterations _____13
- 1.3 ADAAG _____14
- 1.4 Rights-of-Way Guidelines _____15
- 1.5 Industry Guidelines _____16
- 1.6 Other Applicable Laws and Regulations _____16

Chapter 2: Title II Requirements _____17

- 2.1 New Rights-of-Way Construction _____18
- 2.2 Alterations to Developed Rights-of-Way _____19
- 2.3 Program Accessibility in Existing Facilities _____20
 - 2.3.1 Transition Plan _____22
 - 2.3.2 Fundamental Alteration/Undue Burden _____22
 - 2.3.3 Design Standards _____23
- 2.4 Using ADAAG _____23

Part II: Best Practices in Accessible Rights-of-Way Design and Construction

Chapter 3: Pedestrian Accessibility _____29

- 3.1 Introduction_____29
 - 3.1.1 Construction Tolerances _____30
 - 3.1.2 Metrics _____31
 - 3.1.3 Path of Travel _____31
- 3.2 Sidewalks _____33
 - 3.2.1 Width _____33
 - 3.2.2 Running Slope _____34

3.2.3	Cross Slope	37
3.2.4	Surfaces	47
	3.2.4.1 Gratings	50
	3.2.4.2 Gaps	50
	3.2.4.3 Maintenance	51
3.2.5	Pedestrian Envelope	52
3.3	Intersection Design	55
3.3.1	Continuous-Flow Intersections	55
3.3.2	Geometric Design	55
3.4	Curb Ramps	56
3.4.1	Types of Curb Ramps	58
3.4.2	Curb Ramp Usability Considerations	64
3.4.3	Curb Ramp Location	67
3.4.4	Running Slope	75
3.4.5	Cross Slope	76
3.4.6	Transitions	76
3.4.7	Landings	83
3.4.8	Alternatives to Curb Ramps	83
3.5	Pedestrian Street Crossings	86
3.5.1	Street/Sidewalk Detectability	88
3.5.2	Accessible Pedestrian Signals (APS)	90
3.5.3	Types of APS	91
3.5.4	Pedestrian Pushbuttons	92
3.5.5	Crossing Times	93
3.5.6	Marked Crossings	95
3.5.7	Islands	96
3.5.8	Overpasses and Underpasses	96
3.6	Street Furniture and Equipment	101
3.6.1	Benches	101
3.6.2	Telephones	104
3.6.3	Drinking Fountains	104
3.6.4	Sidewalk Toilets	107
3.6.5	Pedestrian Signage	107
3.6.6	Bus Stops	109
3.6.7	Miscellaneous Items	109
3.7	Temporary Facilities	112
3.7.1	Temporary Facilities	112
3.7.2	Temporary Access	112
3.8	Vehicular Ways and Facilities	116
3.8.1	On-Street Parking	116
3.8.2	Scoping	116
3.8.3	Parallel Parking	119
3.8.4	Other On-Street Parking	119
3.8.5	Loading Zones	119
3.8.6	Speed Bumps	119
3.8.7	Callboxes	123

TABLE OF CONTENTS

3.9	Accessible Design Resources	124
3.9.1	Publications	124
3.9.2	Technical Assistance	125
	Appendices	129
A	Pedestrian Planning and Funding under TEA-21	131
B	Accessible Design Resources	136
C	Checklist	144

*"The employment, transportation, and public accommodation sections of... [the ADA] would be meaningless if people who use wheelchairs were not afforded the opportunity to travel on and between the streets."
--Report of the House Committee on Education and Labor*

INTRODUCTION

This design guide was developed by the U.S. Architectural and Transportation Barriers Compliance Board (the Access Board) in collaboration with the U.S. Department of Transportation (DOT)/Federal Highway Administration (FHWA) to assist public works and transportation agencies covered by title II of the Americans with Disabilities Act (ADA) in designing and constructing public sidewalks and street crossings. The recommendations in this publication may also be applied to shared-use paths that occupy a public right-of-way. State and local transportation engineers, planners, landscape architects, civil engineers, and others who design pedestrian facilities will also find useful guidance here for improving existing public pedestrian circulation networks to be more usable by pedestrians who have disabilities.

Title II of the ADA contains both general and specific obligations for State and local governments. Several of these obligations affect the design, construction, maintenance, and improvement of pedestrian facilities, particularly curb ramps. Although final standards for the design and construction of accessible pedestrian facilities in the public right-of-way have not yet been published, existing ADA standards developed for pedestrian routes on sites can be adapted for application to sidewalks and street crossings.

This design guide consists of two parts. Part I contains an overview of ADA title II obligations, particularly as they affect new construction and alterations in the public right-of-way. Part II contains best practices recommendations—and the rationale behind them—for the design, construction, alteration, and retrofit of public pedestrian facilities. By implementing this guidance and, where appropriate, incorporating it in State, local, and industry documents, title II entities can achieve a more consistent approach to the design of accessible rights-of-way features.

Sidebar material in this design guide includes excerpts from the U.S. Department of Justice (DOJ) title II regulation (28 CFR Part 35 Nondiscrimination on the Basis of Disability in State and Local Government Services; Final Rule), the DOJ Title II Technical Assistance Manual, and the ADA Accessibility Guidelines (ADAAG), including advisory material from its Appendix. Examples of accessible rights-of-way design from towns and

cities across the U.S. are also noted. Shorthand checklists of accessible features are provided at major headings for easy reference.

Photographic and figure illustrations highlight exemplary as well as inaccessible design. A particular effort has been made to clarify issues of cross slope and counterslope through drawings.

Appendices to this design guide include a bibliography for those wishing to develop a further understanding of regulatory and design issues. Enclosures on planning and funding under TEA-21 provide an operational context for the pedestrian design environment. A pedestrian facility checklist provides an overview of accessibility requirements.

"The ADA provides for equality of opportunity, but does not guarantee equality of results. The foundation of many of the specific requirements in the Department's regulations is the principle that individuals with disabilities must be provided an equally effective opportunity to participate in or benefit from a public entity's aids, benefits, and services."
--DOJ Title II Technical Assistance Manual

**28 CFR Part 35
 NONDISCRIMINATION ON THE BASIS OF
 DISABILITY IN STATE AND LOCAL GOV-
 ERNMENT SERVICES**

Subpart A-General

§35.101 Purpose

The purpose of this part is to effectuate subtitle A of title II of the Americans with Disabilities Act of 1990 (42 USC 12131), which prohibits discrimination on the basis of disability by public entities.[...]

§35.102 Application

(a) [T]his part applies to all services, programs, and activities provided or made available by public entities.[...]

35.104§ Definitions [...]

Facility means all or any portion of buildings, structures, sites, complexes, equipment, rolling stock or other conveyances, roads, walks, passageways, parking lots, or other real or personal property, including the site where the building, property, structures, or equipment is located.[...]

Public entity means --

- (1) Any State or local government;*
- (2) Any department, agency, special purpose district, or other instrumentality of a State or States or local government; and*
- (3) The National Railroad Passenger Corporation, and any commuter authority (as defined in section 103(8) of the Rail Passenger Service Act).*

CHAPTER 1:

OVERVIEW OF THE AMERICANS WITH DISABILITIES ACT

The Americans with Disabilities Act (ADA) is a civil rights statute that prohibits discrimination against people who have disabilities. Under the ADA, designing and constructing facilities that are not usable by people who have disabilities constitutes discrimination. In addition, failure to make the benefits of government programs, activities, and services available to people who have disabilities because existing facilities are inaccessible is also discrimination.

1.1 Title II of the ADA: State and Local Government Services

Title II, subpart A, of the ADA covers State and local government services, including the design and construction of buildings and facilities and the operation of government programs. Rulemaking authority and enforcement are the responsibility of the Department of Justice (DOJ). However, the Department of Transportation (DOT) has been designated to implement compliance procedures relating to transportation, including those for highways, streets, and traffic management. The Federal Highway Administration (FHWA) Office of Civil Rights oversees the DOT mandate in these areas.

(Title II, subpart B, which is not covered in this design guide, addresses the acquisition and manufacture of transportation vehicles and the operation of certain transportation systems. Rulemaking authority and enforcement for this section of the ADA are the responsibility of DOT and its modal administrations.)

1.2 ADA Implementing Regulations

Title II implementing regulations for subpart A were published in the Federal Register at 56 FR 144 (28 CFR Part 35) on July 26, 1991. These regulations have three parts:

- the **preamble**;
- the **rule**, and
- referenced accessibility **standards** for new construction and alterations.

Part 35, Appendix A (Preamble)**New Construction and Alterations**

...ADAAG is the standard for private buildings and was issued as guidelines by the Architectural and Transportation Barriers Compliance Board (ATBCB) under title III of the ADA. It has been adopted by the Department of Justice and is published as appendix A to the Department's title III rule in today's Federal Register.

The ATBCB has announced its intention to issue title II guidelines in the future. The Department anticipates that, after the ATBCB's title II guidelines have been published, this rule will be amended to adopt new accessibility standards consistent with the ATBCB's rulemaking. Until that time, however, public entities will have a choice of following UFAS or ADAAG, without the elevator exemption.

1.2.1 The Preamble

The preamble contains a section-by-section analysis of the rule. It is a useful guidance document, providing both background and commentary on the rulemaking process and a rationale for the decisions reflected in the rule. It is a good source for examples and illustrations of key provisions, such as program access, undue burden, and technical infeasibility.

1.2.2 The Rule

The text of the DOJ title II rule contains all the requirements that apply to covered State and local government entities under title II, including many general, operational, and communication provisions, in addition to requirements for facility design, construction, and retrofit.

1.2.3 Accessibility Standards for New Construction and Alterations

Title II requires that facilities constructed or altered after January 26, 1992 be designed and constructed to be readily accessible to and usable by people who have disabilities. Work that conforms to the provisions of either the Uniform Federal Accessibility Standard (UFAS) or section 1-10 of the ADA Accessibility Guidelines (ADAAG) is deemed to comply with this requirement. State and local governments may choose to follow either standard.

With respect to street and sidewalk construction, there is little difference between the provisions of ADAAG and those of UFAS. UFAS, published in 1984 to guide Federal construction, is familiar to highway departments and State agencies as a consequence of Federal funding of highway and related construction. When ADAAG was developed in 1991, it was based on UFAS scoping and technical provisions.

This design guide is based on provisions in ADAAG, sections 1-10, published by the Access Board in 1991 and adopted by DOJ as the ADA Standard for Accessible Design for private sector (title III) facilities. DOT has also adopted ADAAG as its standard for accessible facility design (49 CFR Part 37).

ADAAG

1.3 The ADA Accessibility Guidelines contain requirements that apply to new construction and alterations. Organized into five parts, ADAAG includes:

- **general information**, instructions, and definitions (sections 1-3);
- **scoping provisions** that define when, which, and how many elements are required to be accessible (section 4.1.1-4.1.7);
- **technical specifications** for accessible elements (section 4.2-4.35);
- **special occupancy** sections that apply additional scoping and technical provisions to certain facility types (sections 5-10); and
- an advisory **appendix** that offers additional (nonmandatory) information on accessibility (paragraph numbers in the appendix correspond to those in the guidelines, where an asterisk notes a related entry in the appendix).

The scoping provisions may require: (1) that a certain accessible design element, such as a curb ramp, be provided; (2) that if a certain element, such as telephone, is provided, it must be accessible; (3) that a minimum number or percentage of several elements of a type, such as parking spaces, be accessible; or (4) that an element conform to a technical provision or section. A few scoping provisions permit limited exceptions to the general application of accessibility requirements.

Technical provisions describe the characteristics of an accessible element, such as the slope of a ramp, the turning space required at a landing, or mounting heights for operating hardware. Some building elements—telephones are a good example—are subject to several kinds of technical provisions as a result of separate scoping provisions. Some units must be installed at a height accessible to people who use wheelchairs; some must be equipped for use by people who are hard of hearing; others must incorporate a text telephone or support the connection of a portable text telephone. The technical provisions specify the accessibility required in scoping.

ADAAG scoping and technical provisions for new construction and alterations

These requirements [section 14 of the Access Board's Interim Final Rule]...are not yet included in the Department's regulation. Therefore, compliance with the requirements of section 14...is not required. Until this Department publishes a final regulation that establishes specific requirements for accessible public sidewalks, public entities may elect to meet their obligation to provide accessible sidewalks by using the technical provisions applicable to accessible exterior routes under the ADA Standard [ADAAG] or UFAS, or they may follow any other accessibility standard in effect in their jurisdiction.

--DOJ technical assistance letter

"If there are no applicable scoping requirements (i.e., how many features must be accessible), then a reasonable number, but at least one, must be accessible."

--DOJ Title II Technical Assistance Manual

apply to work that is undertaken within the boundary of a site. Many of these provisions can also be applied to the design of pedestrian facilities in the public right-of-way, such as walks, ramps, and other circulation routes; street furniture; curb ramps, marked crossings, and islands; parking; and similar design elements.

1.4

Rights-of-Way Guidelines

In 1994, the Access Board proposed more specific rights-of-way guidelines as part of an interim final rule containing special application sections for certain State and local government facilities. Section 14 of the interim rule adapted basic ADAAG 1-10 provisions for application to public rights-of-way, but was not adopted as part of the DOJ Standard for Accessible Design. In November 1999, the Board established a Federal advisory committee to develop final rights-of-way provisions from section 14 proposals. DOJ action to include rights-of-way Standards in the title II regulation is expected in 2001.

This does not mean, however, that public rights-of-way are not covered by the ADA. Title II requires non-discrimination in all programs, services, and activities of public entities. The construction, alteration, or maintenance of the public rights-of-way is an activity of a public entity and is therefore subject to the nondiscrimination requirements. Although no Federal scoping or technical requirements have been established that apply specifically to public rights-of-way, both ADAAG and UFAS contain technical requirements for the construction of accessible exterior pedestrian routes that may be applied to the construction of public rights-of-way. In the absence of a specific Federal standard, public entities may also satisfy their obligation by complying with any applicable State or local law that establishes accessibility requirements for public rights-of-way that are equivalent to the level of access that would be achieved by complying with ADAAG or UFAS.

Massachusetts has passed legislation requiring access for pedestrians and bicyclists in all new, reconstructed, and major maintenance projects.

Owasso, MI lends Community Development Block Grant (CDBG) funds to assist in projects that remove barriers in downtown facilities.

A streetscape project in Cordell, OK is using \$300,000 in Federal Transportation Enhancements funding to improve pedestrian accessibility and complement Main Street Program historic restorations.

This design guide has been developed to provide uniform guidance to State and local governments on how to design and construct accessible public pedestrian facilities until such time as the Access Board, DOJ, and DOT issue final requirements.

1.5 Industry Guidelines

Transportation organizations have also begun to incorporate accessibility requirements in their own guidelines and documents of good practice. Industry organizations are considering the joint development of pedestrian guidelines to complement the bicycle guidelines now in preparation for the American Association of State Highway and Transportation Officials (AASHTO). Many State and local government transportation agencies have already adopted pedestrian standards that include accessibility requirements. Several of these were based on the proposed provisions of the Access Board's right-of-way guidelines in section 14 (now withdrawn).

1.6 Other Applicable Laws and Regulations

Street, sidewalk, and shared-use path construction that is funded wholly or in part with Federal monies is also subject to the Architectural Barriers Act of 1968 and the Rehabilitation Act of 1973, both of which currently reference the accessibility standards in UFAS. DOT implementing regulations requiring curb ramps and other accessibility features on Federal-aid highway construction covered by section 504 of the Rehabilitation Act have recently been amended to reference ADAAG rather than UFAS.

Other Federal laws, including the Federal-aid Highway Act of 1973, the Urban Mass Transit Act of 1973, and the Transportation Equity Act for the 21st Century (TEA-21), all include accessibility objectives. Federal-aid programs are a primary funding source for pedestrian accessibility improvements; many access projects have been funded by transportation enhancement monies. TEA-21 clarified that accessibility improvements to pedestrian facilities are eligible for funding under the Surface Transportation Program. Approximately \$33 billion is authorized over the six years of the program (1998-2003) for sidewalk improvements to comply with the Americans with Disabilities Act. In addition, transportation engineers are directed to consider accessible traffic signals where appropriate. The increased emphasis on pedestrian and bicycle modes in TEA-21 greatly expands both the opportunities for and obligations to achieve rights-of-way access. The ADA requires that all pedestrian projects be accessible, regardless of funding sources.

"Under this regulation [DOJ implementing regulations for title II of the ADA], maintenance of pedestrian walkways by public entities is a covered program that is required to be made accessible by the installation of curb ramps where existing pedestrian routes cross curbs..."

--DOJ Title II Technical Assistance Manual

§35.151 New construction and alterations

(a) Design and construction. Each facility or part of a facility constructed by, on behalf of, or for the use of a public entity shall be designed and constructed in such manner that the facility or part of the facility is readily accessible to and usable by individuals with disabilities, if the construction was commenced after January 26, 1992.

(b) Alteration. Each facility or part of a facility altered by, on behalf of, or for the use of a public entity in a manner that affects or could affect the usability of the facility or part of the facility shall, to the maximum extent feasible, be altered in such a manner that the altered portion of the facility is readily accessible to and usable by individuals with disabilities, if the alteration was commenced after January 26, 1992.

(c) Accessibility standards. Design, construction, or alteration of facilities in conformance with the Uniform Federal Accessibility Standards (UFAS) or with the Americans with Disabilities Act Accessibility Guidelines for Buildings and Facilities (ADAAG) shall be deemed to comply with the requirements of this section with respect to those facilities...Departures from particular requirements of either standard by the use of other methods shall be permitted when it is clearly evident that equivalent access to the facility or part of the facility is thereby provided.[...]

(e) Curb ramps.

(1) Newly constructed or altered streets, roads, and highways must contain curb ramps or other sloped areas at any intersection having curbs or other barriers to entry from a street level pedestrian walkway.

(2) Newly constructed or altered street level pedestrian walkways must contain curb ramps or other sloped areas at intersections to streets, roads, or highways.

CHAPTER 2: TITLE II REQUIREMENTS

A public pedestrian circulation network is both a "program", i.e., a service delivered by a government to its citizens, and a set of "facilities," e.g., the sidewalks, curb ramps, street crossings, and related pedestrian elements that are instrumental in providing the service.

Title II of the ADA requires accessibility in both the construction and operation of facilities and programs:

- new and altered **facilities** must be designed and constructed to be accessible to and usable by individuals with disabilities;
- existing facilities and **programs** must achieve program accessibility.

In addition, title II adds more specific rights-of-way coverage:

- **new and altered** streets with sidewalks must contain curb ramps;
- certain **existing** pedestrian routes must be retrofitted with curb ramps.

It is a measure of their importance to accessible pedestrian circulation that curb ramps are the only construction item expressly required in the title II regulation.

2.1 New Rights-of-Way Construction

The highest degree of accessibility is required in new work, at the time when it is most cost-effective to incorporate accessible design features. Compliance is measured against the applicable technical specifications in the new construction standard.

Examples of new right-of-way construction include the application of municipal land development standards to new subdivisions, the extension of an existing right-of-way into newly annexed territory, and the master planning, design, and construction of a new town center.

ADAAG 4.1.6(1) Alterations.

(j) *EXCEPTION: In alteration work, if compliance with 4.1.6 is technically infeasible, the alteration shall provide accessibility to the maximum extent feasible. Any elements or features of the building or facility that are being altered and can be made accessible shall be made accessible within the scope of the alteration.*

Technically infeasible. Means, with respect to an alteration of a building or facility, that it has little likelihood of being accomplished because [...] site constraints prohibit modification or addition of elements, spaces, or features that are in full and strict compliance with the minimum requirements for new construction and which are necessary to provide accessibility.

“What does ‘maximum extent feasible’ mean?”

Occasionally, the nature of a facility makes it impossible to comply with all of the alterations standards. In such a case, features must only be made accessible to the extent that it is technically feasible to do so. The fact that adding accessibility features during an alteration may increase costs does not mean compliance is technically infeasible. Cost is not to be considered...”

–DOJ Title II Technical Assistance Manual

In downtown Auburn, AL a complying passageway was constructed along building facades at a sidewalk elevation that eliminated steps at each shop entrance. The sidewalk run at the curb was retained, with landscape elements separating the two. Ramps connected the two levels at several points along the sidewalk.

2.2 Alterations to Developed Rights-of-Way

An alteration is a change that affects (or could affect) access to or usability of a facility or a part of a facility. If a covered entity alters an existing facility or part of a facility, the altered area must be accessible to and usable by people who have disabilities to the maximum extent feasible.

Alterations must follow the ADA Standards for Accessible Design unless compliance is technically infeasible. Where the nature of an existing facility makes it virtually impossible to comply with all of the accessibility standards applicable to planned alterations, any altered features of the facility that can be made accessible must be made accessible.

Additionally, because alterations to existing rights-of-way offer fewer opportunities to mitigate the effects of topography and to incorporate maneuvering space and other accessibility features, accessibility guidelines include less stringent technical criteria for some conditions, such as a steeper permitted slope for a curb ramp where it may be technically infeasible to meet new construction requirements. Alterations, however, may not be undertaken that have the effect of reducing existing levels of accessibility below the requirements for new construction.

Examples of alterations in rights-of-way construction include a downtown sidewalk improvement project, a roadway realignment or widening, or the addition of a sidewalk along an existing right-of-way. Where additional right-of-way is acquired for a roadway project, it is important to consider accessible sidewalk construction, where appropriate. Such right-of-way acquisitions may also offer opportunities to improve access to adjacent sites and existing facilities.

Some ADA compliance problems, and even court cases, have arisen from differing interpretations of the term “alteration.” Many highway agencies consider the removal of a wearing surface and its replacement with a new thickness of paving as merely routine maintenance—part of the long-term maintenance program for a roadway—and, therefore, not an “alteration.” The ADA definition of an alteration, however, is much broader. The DOJ title II implementing regulation (see 28 CFR §35.151) defines an alteration as a

"Resurfacing beyond normal maintenance is an alteration. Merely filling potholes is considered to be normal maintenance."

--DOJ Title II Technical Assistance Manual

In *Kinney vs Yerusalim* (812 F. Supp. 547 [F.D. PA, 1993]), a district court determined that the resurfacing of public streets in the city of Philadelphia was an alteration that affected the usability of the street and thus triggered the requirement for curb ramp installation at intersections under the DOJ title II regulation.

"When streets, roads, or highways are newly built or altered, they must have ramps or sloped areas wherever there are curbs or other barriers to entry from a sidewalk or path. Likewise, when new sidewalks or paths are built or altered, they must contain curb ramps or sloped areas wherever they intersect with streets, roads, or highways."

--DOJ technical assistance letter

Appendix A to Part 35
[Preamble, including section-by-section analysis]

§35.150 Existing facilities

...The concept of "program accessibility" was first used in the section 504 regulation adopted by the Department of Health, Education, and Welfare for its federally assisted programs and activities in 1977. It allowed recipients to make their federally assisted programs and activities available to individuals with disabilities without extensive retrofitting of their existing buildings and facilities, by offering those programs through alternative methods. Program accessibility has proven to be a useful approach and was adopted in the regulations issued for programs and activities conducted by Federal Executive agencies. The [ADA] provides that the concept of program access will continue to apply with respect to facilities now in existence, because the cost of retrofitting existing facilities is often prohibitive.[...]

In choosing among methods, the public entity shall give priority consideration to those that will be consistent with provision of services in the most integrated setting appropriate to the needs of individuals with disabilities. Structural changes in facilities are only required when there is no other feasible way to make the public entity's program accessible. (It should be noted that "structural changes" include all physical changes to a facility...[...])

...[A] public entity should provide an adequate number of accessible parking spaces in existing parking lots or garages over which it has jurisdiction.

"Installation of curb ramps to provide access

change that "...affects or could affect the usability of a facility or part of a facility." In *Kinney v. Yerusalim*, a Federal district appeals court decision held, "if a street is to be altered to make it more usable by the general public, it must also be made more usable for those with ambulatory disabilities." If resurfacing affects the usability of a street for motor vehicles (or for pedestrians at crosswalks), curb ramps must be included where pedestrian routes cross curbs or other barriers to use. Surface projects of more limited scope, such as spot patching, thincoat sealing, reseating of disturbed curbing, restriping of existing markings in place, and similar efforts, could be considered as maintenance rather than alterations. FHWA policy states that agencies should plan to incorporate curb ramps on all resurfacing projects beyond normal maintenance where pedestrian routes exist.

The placement of benches, public telephones, or public toilets at specified locations within a developed streetscape or the addition of pedestrian signals at a street crossing should also be considered alterations requiring accessible features for those elements within the scope of the project.

Program Accessibility

2.3 in Existing Facilities

Program accessibility is a provision of the ADA and DOJ title II regulations—not ADAAG, and applies to the existing facilities and programs of a jurisdiction. It allows a range of methods to ensure that people who have disabilities are not denied access to public programs. In many situations, an operational solution may achieve program accessibility without the need for construction.

The concept of program accessibility has been widely misunderstood. Derived from regulations implementing the Rehabilitation Act of 1973, the idea of providing access to programs—not just to facilities—permits a broader and more flexible range of solutions to existing access problems. Subpart D (Program Accessibility) of the title II regulation begins with a general prohibition of discrimination, stating that a government may not deny the benefits of its programs, activities, and services to people with disabilities because its existing facilities are inaccessible. It goes on to require that title II entities operate their programs so that they are available to people with disabilities. In fact, existing facilities do not have to be made accessible if other methods of providing access are effective. Except for the installation of curb ramps—which are specifically required for program

to existing pedestrian walkways on existing streets that are not otherwise being altered may be necessary in order to provide access to the 'program' of using public streets and walkways..."

--DOJ Title II Technical Assistance Manual

"To achieve or maintain program accessibility, it may be appropriate to establish an ongoing procedure for installing curb ramps on request in areas frequented by individuals with disabilities as residents, employees, or visitors."

--DOJ Title II Technical Assistance Manual

*Subpart D-Program Accessibility
§35.149 Discrimination prohibited
[N]o qualified individual with a disability shall, because a public entity's facilities are inaccessible to or unusable by individuals with disabilities, be excluded from participation in, or be denied the benefits of the services, programs, or activities of a public entity or be subjected to discrimination by any public entity.*

access—structural changes are an option of last resort.

A pedestrian circulation system—sidewalks, street crossings, shared-use paths in the public right-of-way—is a program that a local government provides for its citizens. And it is the general availability of this program to people with disabilities that must be evaluated when considering the existing pedestrian environment. Full compliance with facility standards developed for new construction and alterations may not be required to achieve program access.

Program accessibility can be thought of as providing a basic level of usability. It targets high-priority access improvements—such as curb ramps—that eliminate major barriers to the use of existing facilities, so that people with disabilities are not excluded from participation. Program accessibility requires careful planning to identify those efforts that will provide the greatest access for the resources available. Non-construction approaches may include alternate accessible routings, relocating services or activities to accessible locations, or taking the service or benefit directly to the individual.

Jurisdictions should consider whether such operational solutions will be supportable over the long term. For some rights-of-way elements, structural changes may be more economical.

In an existing right-of-way that is not otherwise being altered, the minimum requirement for achieving program accessibility is the installation of curb ramps at selected locations where existing pedestrian walkways cross curbs. This work must be identified in the transition plan required of public entities covered by title II.

The Build Greater Austin Program in Austin, TX has dedicated \$3.6m to sidewalk installation, prioritizing improvements along transit routes. An accessibility advisory group identifies locations needing curb ramps, maintenance, barrier removal, and other spot improvements for pedestrians with disabilities.

"To promote both efficiency and accessibility, public entities may choose to construct curb ramps at every point where a pedestrian walkway intersects a curb. However, public entities are not necessarily required to construct a curb ramp at every such intersection."

--DOJ Title II Technical Assistance Manual

"Alternative routes that make use of existing curb cuts may be acceptable under the concept of program accessibility in limited circumstances where individuals with disabilities need only travel a marginally longer route. In addition, the fundamental alterations and undue burdens limitations may limit the number of curb ramps required."

--DOJ Title II Technical Assistance Manual

The San Francisco Department of Public Works has established a 5-point ranking system to identify and prioritize curb ramp installation. Of highest priority are locations with existing ramps that are deemed unsafe. Ranking second are locations where no curb ramp currently exists at a pedestrian crossing. A third category will add a curb ramp at a location where only one crossing direction currently has a curb ramp. Priority four includes substandard curb ramps that do not fully comply with standards but are considered safe to use. Of lowest priority are severely-constrained locations where curb ramp installation alone would be prohibitively expensive and require substantial reconstruction.

2.3.1 Transition Plan

Where structural modifications are necessary to achieve program accessibility—as in the addition of curb ramps—the DOJ regulation requires State and local governments that employ 50 or more staff members to develop a transition plan that provides for the removal of the barriers at issue. With respect to pedestrian facilities, the DOJ regulation imposes a specific construction requirement. This requirement directs each jurisdiction to include in its transition plan a schedule for providing curb ramps where pedestrian walkways cross curbs and specifies a priority for locating them at:

- State and local government offices and facilities;
- transportation;
- places of public accommodation (private sector facilities covered by title III);
- places of employment; and
- other locations (for instance, along routes used by residents with disabilities).

DOJ's Title II Technical Assistance Manual notes that curb ramps may not be required at every existing walkway if a basic level of access to the pedestrian network can be achieved by other means, e.g., the use of a slightly longer route.

Action items listed in a community's transition plan, including the installation of curb ramps at specified existing pedestrian walkways, were to have been completed by January 26, 1995. Entities that have not finished this work should review and update their schedules and place a high priority on accomplishing the work necessary to complete plan items and elements.

2.3.2 Fundamental Alteration and Undue Burden

The program accessibility obligation for existing facilities does not require a covered entity to take any action that it can demonstrate would result in a fundamental alteration in the nature of a service, program, or activity or in undue financial and administrative burdens. The decision that compliance would result in such alterations or burdens must be made by the head of a public entity or his or her designee after considering all resources available for use in the funding and operation of the service, program, or activity, and must be accompanied by a written statement of the reasons for reaching that

§35.164 Duties

This subpart does not require a public entity to take any action that it can demonstrate would result in a fundamental alteration in the nature of a service, program, or activity or in undue financial and administrative burdens. [...]

If an action required to comply with this subpart would result in such an alteration or such burdens, a public entity shall take any other action that would not result in such an alteration or such burdens but would nevertheless ensure that, to the maximum extent possible, individuals with disabilities receive the benefits or services provided by the public entity.

The National Organization on Disability recognized the town of Eagle Point, OR with a community service award for the renovation of its downtown to improve access for people with disabilities. Utility poles were moved, new sidewalks and sidewalk connectors were constructed, curb ramps were added, and barriers to access to retail facilities along the sidewalk have been removed.

conclusion. Furthermore, such a decision does not relieve the entity from obligations to take other remedial actions (to ensure that individuals with disabilities receive the benefits or services provided by the entity) that do not constitute an undue burden or fundamental alteration. See the DOJ regulation at 28 CFR §35.150(a)(3) and related preamble discussion for guidance.

2.3.3 Design Standards

Although structural changes undertaken for program accessibility must aim at meeting ADAAG technical provisions, it may not be feasible to achieve full accessibility in all elements and features in the developed right-of-way environment. For instance, reconstruction of the sidewalk area and relocation of existing features on it will not generally be necessary to achieve program accessibility at an existing intersection. If it is not possible to install a curb ramp that is fully compliant with ADAAG in an existing sidewalk, each feature of accessibility should be maximized within the constraints of site conditions at that location. Every such decision must be arrived at individually, after considering the effects of contributing factors. While a standardized approach may be possible in new construction, where finished conditions can be specified within general tolerances, designing program access solutions requires case-by-case attention to field conditions. Designers who are familiar with the rationale behind accessibility specifications will be prepared to balance possible options to achieve a usable whole.

Using ADAAG

2.4 Private sector entities covered by title III must use ADAAG scoping and technical provisions for new construction and alterations when designing buildings, facilities, and related site improvements. Where pedestrian routes are provided within the boundaries of a site from parking areas, public sidewalks, or public transportation stops and building entrances, at least one route must meet ADAAG criteria for an accessible route. In addition, where pedestrian routes connect buildings and facilities on a common site, such as in an office park, multibuilding complex, recreation area, shopping center, or school campus, at least one such route must be accessible. Pedestrian elements along accessible routes—telephones, drinking fountains, kiosks, and similar facilities—must also meet ADAAG requirements. ADAAG site development criteria require that on-site connections to public streets, sidewalks, and transportation facilities must be accessible.

“What if neither ADAAG nor UFAS contain specific standards for a particular type of facility?”

In such cases, the technical requirements of the chosen standard should be applied to the extent possible. If no standard exists for particular features, those features need not comply with a particular design standard. However, the facility must still be designed and operated to meet other title II requirements, including program accessibility.

ILLUSTRATION: A public entity is designing and constructing a playground. Because there are no UFAS or ADAAG standards for playground equipment, the equipment need not comply with any specific design standard. The title II requirement for equal opportunity and program accessibility, however, may obligate the public entity to provide an accessible route to the playground, some accessible equipment, and an accessible surface for the playground.”

--DOJ Title II Technical Assistance Manual

ADAAG 3.5 Definitions.

Accessible Route. A continuous unobstructed path connecting all accessible elements and spaces of a building or facility...

Exterior accessible routes may include parking access aisles, curb ramps, crosswalks at vehicular ways, walks, ramps, and lifts.

ADAAG (or UFAS) is also the design standard for public entities constructing individual or multiple facilities on sites bounded by property lines or rights-of-way. The design of a new city hall, government center, courts or correctional complex, State university campus, municipal park, or public zoo must comply with title II site development and building standards.

Scoping and technical provisions that govern such construction can be found at: **ADAAG 4.1.2 Accessible Sites and Exterior Facilities, ADAAG 4.1.3 New Construction, and ADAAG 4.1.6 Alterations.**

ADAAG provisions have been developed from research that measures the responses of a wide range of people with disabilities. The features that are required in ADAAG for the accessible route on a site are, for the most part, the same features necessary to ensure the accessibility of a public sidewalk or shared-use path in the public right-of-way. For example, an abrupt 1/2-inch (13 mm) change in level is as significant a barrier to wheelchair travel on a public sidewalk as it is on an accessible route on a site.

Not all the design criteria required of an accessible route on a site, however, may be feasible in a public right-of-way. For example, it may not be possible in sloping terrain to limit the running slope of a sidewalk to 1:12 (8.33%), which is the maximum permitted for a ramp on an accessible route. Nor is it practical to propose that sloping walks be uniformly provided with handrails. Applying such standards could interfere with the normal use of pedestrian circulation facilities. Nevertheless, it is wise to plan new sidewalks to minimize running slope as much as is feasible and, where walkways are steep, to consider elements that may make them more usable, including handrails, level landings at reasonable intervals, and benches for resting.

Technical provisions for accessible features appropriate to pedestrian facilities may be found in the following sections of ADAAG:

- 4.2 Space Allowance and Reach Range**
- 4.3 Accessible Route**
- 4.4 Protruding Objects**
- 4.5 Ground and Floor Surfaces**
- 4.6 Parking and Passenger Loading Zones**
- 4.7 Curb Ramps**

- 4.8 Ramps
- 4.9 Stairs
- 4.15 Drinking Fountains
- 4.22 Toilet Facilities
- 4.27 Controls and Operating Mechanisms
- 4.29 Detectable Warnings
- 4.30 Signage
- 4.31 Public Pay Telephones
- 4.32 Fixed or Built-in Seating and Tables
- 4.34 Automated Teller Machines

CHAPTER 3: PEDESTRIAN ACCESSIBILITY

The Access Board and the Federal Highway Administration have jointly developed the guidance in this technical assistance manual to encourage standardization in the accessible design and construction of new sidewalks, curb ramps, street crossings, and related pedestrian facilities. The recommendations that follow have been adapted from site and building provisions to meet the special conditions encountered in the public right-of-way. Although these recommended practices have been developed for new construction and alterations, jurisdictions will also find useful guidance here on improving the usability of existing pedestrian facilities.

3.1 Introduction

Pedestrians who have mobility impairments, including those who use wheelchairs, will benefit most from design approaches that minimize physical barriers to travel and maneuverability. Pedestrians with cognitive and sensory impairments, particularly those who have limited vision and those who are blind, should have access to information on the pedestrian environment that is necessary for independent travel.

Most provisions in the standards can be applied without difficulty when new construction or alteration of streets and sidewalks, is undertaken. The DOJ Title II Technical Assistance Manual advises covered entities to apply appropriate ADAAG (or UFAS) technical provisions to the extent possible when no standards exist for particular features.

Many States have adopted these or similar standards; several require a higher degree of accessibility in public rights-of-way. DOJ technical assistance rendered in response to questions about ADA coverage of sidewalks in residential areas notes that public sidewalks are considered a “program” of State or local government. Where sidewalk construction is undertaken by, on behalf of, or subject to, the design standards of a public jurisdiction, it must be accessible to pedestrians who have disabilities. Public sidewalks, curb ramps, street crossings, and other pedestrian features that meet ADAAG, UFAS, or other accessible design criteria (that meet or exceed ADA accessibility requirements) in effect in a jurisdiction are deemed to comply with ADA title II requirements.

3.1.1 Construction Tolerances

The right-of-way environment is typically held to less exacting tolerances for finishes, dimensions, and other parameters than are buildings and other facilities. It is rare for a fractional dimension to have significance in highway specifications. The dimensions of accessibility, however, must be more finely measured: a difference of more than 1/4 inch (6.5 mm) in the elevation of adjacent surfaces can significantly affect the usability of a walkway; a change in slope from 1:12 (8.33%) to 1:10 (10%) may preclude the independent use of a curb ramp by some pedestrians. For this reason, it is particularly important to design and specify exterior facilities that are well within the limits established in accessibility standards.

By specifying the maximum permissible slope, an engineer may miss the opportunity to achieve a lesser and, therefore, more usable slope. Furthermore, field construction based on such a specification may fail to achieve the access that is required, leading to liability for changes that may be costly. Dimensions noted in accessibility provisions as “maximum” or “minimum” should not, therefore, be considered dimensions for design, because they represent the limits of a requirement. To be sure that field tolerances result in usable construction, notes and dimensions in construction documents should identify and incorporate expected tolerances so that a required dimension is not exceeded by the addition of a finish or a variation in construction practice. Plans that reflect such considerations also provide a better basis for decision making in the field.

The City of Roseville, CA directs contractors to set extruding machines and forms at a 1.5% cross slope for sidewalks generally, and at 1% for those with steep longitudinal grades to avoid inadvertently exceeding the 2% maximum.

3.1.2 Metrics

Dimensions noted in accessibility guidelines have been derived from research conducted in English units. Metric equivalents currently incorporated in the guidelines do not conform to transportation industry practices. (“Hard” mathematical conversions are used in accessibility guidelines, while “soft” close equivalents based on standardly-rounded metric units are the basis for highway dimensions.) Industry conversion tables typically do not include lengths of less than 1 inch (25 mm). These conversion tables thus cannot express the difference, as provided in ADAAG, between a lip of 1/4 inch (6.5 mm), which is permitted to be vertical, and one of 1/2 inch (13mm), which must be beveled. Such differences can be important to the usability of a pedestrian route. The following conversion table has been

proposed for upcoming revisions to the ADA Accessibility Guidelines:

English (inch/feet)	Metric Rounding Tolerance (inches x 25.4, rounded to: mm/m)
<1/2 inch	nearest tenth of a millimeter
1/2 inch to <3 inches	nearest millimeter
3 inches to <10 feet	nearest 5 millimeters
10 feet to ~33 feet	nearest 10 millimeters (where conversion is less than 10 000 mm)
~33 feet and greater	nearest meter (where conversion equals or exceeds 10 000 mm)

Dimensions specified in this document note the English unit first (as specified in the ADA standards), followed in parentheses by its metric equivalent (from the chart above). Although ADAAG initially (1991) specified cross slope at 1:50 (2%) maximum, site design practices in architecture and landscape architecture continue to use 1:48—or the easily-figured 1/4 inch per foot—for the English-unit measure. Revisions to ADAAG will recognize this practice by establishing 1:48 (2%) as the equivalent for cross slope. This manual also adopts that practice.

3.1.3 Path of Travel

On a site, the property line establishes the limits of the obligation to improve the path of travel to an altered area of a building or facility. In the public right-of-way, the path-of-travel obligation is contained within the scope and physical limits of an improvement contract or project limit. The altered area should, to the maximum extent feasible, provide an accessible connection to adjacent existing segments of the pedestrian network and related pedestrian facilities. Where necessary, corresponding modifications to adjacent areas within the project limits may be needed to ensure that grades, finishes, and surfaces will meet or match those of the alteration. This is routinely done in roadway and sidewalk construction. The Department of Justice has not interpreted the path-of-travel obligation to extend beyond the limits of an alteration project and its connections to existing improvements.

3.2 Sidewalks

Sidewalks are walkways that parallel a street or highway within the roadway border width. The term generally implies a separated (horizontally and/or vertically) and paved surface. Sidewalks in the public right-of-way most commonly border and take the slope of adjacent roadways.

Shared-use paths may also serve a pedestrian circulation/transportation function, particularly in suburban and rural rights-of-way. Where such a route is located in a public right-of-way and provides a direct pedestrian connection between neighborhoods, residential areas, schools, employment centers, and other origins and destinations, it must be accessible.

Other public pedestrian routes may parallel water or rail transportation corridors or occupy public rights-of-way in easements. Roadway shoulders may also be used by and improved for pedestrians. When used for utilitarian circulation purposes (rather than recreation, for example), pedestrian facilities are considered a transportation mode.

In urban areas, sidewalks predominate; in outlying areas and in the pedestrian transportation corridors that link them to other destinations, shared-use paths may be more common. Because each route provides a unique connection between diverse origins and destinations, such pedestrian routes, when they occupy the public right-of-way, must be designed and constructed to be accessible.

Pedestrian routes that are located within sites rather than in the public right-of-way must comply with ADAAG (or UFAS, if it is a public, Federal, or Federally assisted project). Site planners must provide at least one accessible route from public transportation stops, accessible parking, and accessible passenger loading zones, and public streets and sidewalks to the accessible building entrance they serve. At least one accessible route also must connect accessible buildings, facilities, and spaces that are on the same site.

Trails designed for recreation on sites, in parks, and in wilderness areas are included in a separate ADA rulemaking now under development by the Access Board. Additional guidelines specific to recreation uses will be proposed by the Board in future rulemakings.

This manual addresses sidewalks, walkways, and similar pedestrian transportation routes that are located within a public right-of-way. Given the importance of pedestrianism as a transportation mode and the fact that the pedestrian routes are used even when affected by rain, snow, or ice, providing more than the minimum of access features is strongly encouraged.

The utilitarian transportation function of sidewalks also suggests a high priority for accessibility. Ideally, the sidewalk network that makes up a public pedestrian circulation system should permit passage to every address and pedestrian feature on or along every pedestrian route.

"The ADA...does not require the provision of an accessible route in cases where there is no pedestrian route for the general public...Whether a route for the general public exists within a site depends upon the unique characteristics of the site, including its geography and proximity to public transportation stops. Factors such as the presence of sidewalks, crosswalks, or significant pedestrian flow along a particular route should also be considered in determining whether a route for the general public exists..."

--DOJ Title II Technical Assistance Manual

The pedestrian provisions in the "Green Book" of the American Association of State Highway and Transportation Officials (AASHTO) recommend sidewalk construction for most locations. New directives in Federal transportation legislation support the provision of pedestrian and bicycling elements whenever roadway work is undertaken. However, ADA implementing regulations do not require paved walks or curb ramps where pedestrian routes are not otherwise provided. When a pedestrian route is constructed, however, it must be accessible.

3.2.1 Width

Walkway width recommendations in current transportation industry guidelines generally exceed the 36-inch (915-mm) minimum needed for accessible travel. The Institute of Transportation Engineers (ITE), in its 1998 recom-

SIDEWALK WIDTH

- ✓ 36" (915 mm) minimum for travel;
32" [815 mm] at a point
- ✓ 60" (1525 mm) minimum for passing
space or U-turn
- ✓ extra room where turning or maneuvering is required

ADAAG Appendix: A4.2.1(2) Space Requirements for Use of Walking Aids.

Although people who use walking aids can maneuver through clear width openings of 32 in (815 mm), they need 36 in (915 mm) for comfortable gaits. Crutch tips, often extending down at a wide angle, are a hazard in narrow passageways where they might not be seen by other pedestrians...

(3) Space Requirements for Passing. Able-bodied persons in winter clothing, walking straight ahead with arms swinging, need 32 in (815 mm) of width, which includes 2 in (50 mm) on either side for sway, and another 1 in (25 mm) tolerance on either side for clearing nearby objects or other pedestrians. Almost all wheelchair users and those who use walking aids can manage within this 32 in (815 mm) width for short distances. Thus, two streams of traffic can pass in 64 in (1625 mm) in a comfortable flow. Sixty in (1525 mm) provides a minimum width for a somewhat more restricted flow. If the clear width is less than 60 in (1525 mm), two wheelchair users will not be able to pass but will have to seek a wider place for passing. Forty-eight inches (1220 mm) is the minimum width needed for an ambulatory person to pass a non-ambulatory or semi-ambulatory person. Within this 48 in (1220 mm) width, the ambulatory person will have to twist to pass a wheelchair user, a person with a service animal, or a semi-ambulatory person. There will be little leeway for swaying or missteps.

mended practice publication, "Design and Safety of Pedestrian Facilities," recommends planning sidewalks that are a minimum of 5 feet wide (1525 mm) with a planting strip of 2 feet (610 mm) on local streets and in residential and commercial areas. Sidewalks in central business districts should be wide enough to meet level-of-service criteria. AASHTO's "Green Book" recommends a minimum paved width of 3 meters—approximately 10 feet—for shared-use paths. The accessible widths in UFAS and ADAAG are minimums for passage, not sidewalk width recommendations (SEE FIGURE 1).

Because wheelchairs, like other wheeled vehicles, do not track within the same path when turning, additional length and width are necessary at turns. And because the length of a wheelchair space—48 inches (1220 mm)—exceeds its width of 30 inches (760 mm), extra walkway width is necessary to turn and operate an entrance door, to approach and activate a pedestrian crossing signal button, or to enter or leave a curb ramp (SEE FIGURE 1). Passing space for two wheelchairs can be provided in a space that is 60 inches (1525 mm) wide, which is usually available at a corner, a driveway, or a building entrance (ADAAG requires passing spaces to be located at reasonable intervals, not to exceed 200 feet/61 m, along accessible routes). A circle 60 inches (1525 mm) in diameter will minimally accommodate a full reverse in direction.

Narrow sidewalks immediately adjacent to street curbs provide little margin for maneuvering, particularly in crowds when line of sight is limited or when water, snow, or ice make control less precise. A moment's inattention or a blocked view may well result in a fall if a crutch tip or wheel drops off a sidewalk edge or into a planting recess. Wider walkways minimize the hazards presented by such dropoffs.

Some pedestrians who use crutches need as much as 42 inches (1065 mm) in width to achieve a comfortable gait. An individual traveling with a service animal or sighted guide will use a minimum of 48 inches (1220 mm) of width for easy passage. Sidewalks that are at least 60 inches (1525 mm) wide allow pedestrians to travel comfortably side-by-side and are the minimum convenient width for turning or passing.

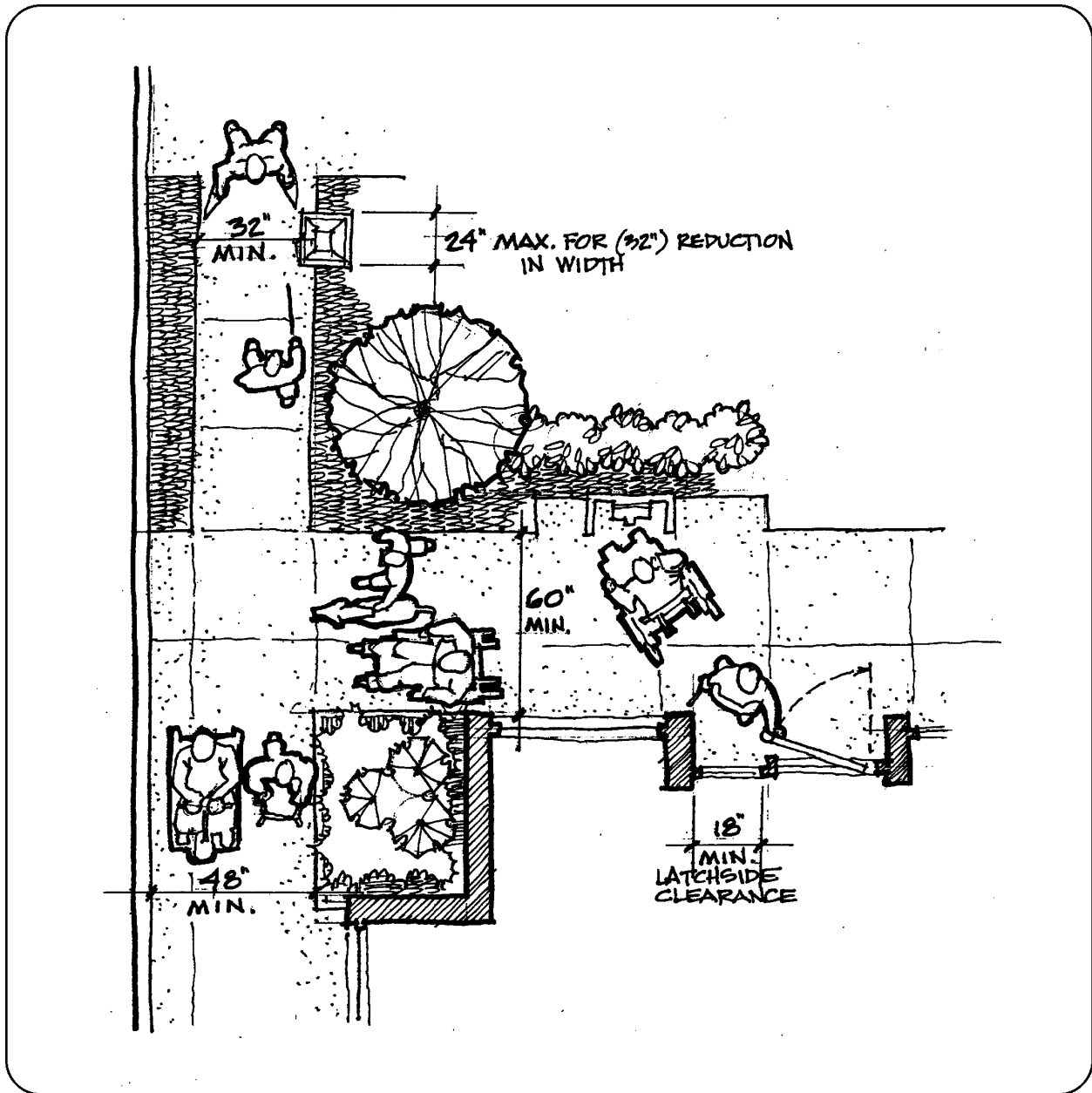

1

Passage widths within sidewalk

Dimensions shown are minimums necessary for usability. Overall sidewalk widths will generally exceed these dimensions. Note maneuvering space requirements for use of doors and wheelchair space requirements at street furniture such as telephones, drinking fountains, and similar elements.

SIDEWALK SLOPE

- ✓ minimum slope consistent with roadway
- ✓ 2% maximum cross slope ("level"), including driveways

In many hilly cities—Seattle, Pittsburgh, San Francisco—handrail segments have been provided along steeply sloping sidewalks where building facades permit.

In response to advocacy from residents with disabilities, the Sacramento County, CA Board of Supervisors has adopted a policy that limits the distance that a sidewalk may depart from the horizontal or vertical alignment of the adjacent roadway.

"A public entity must reasonably modify its policies, practices, or procedures to avoid discrimination..."

ILLUSTRATION: A municipal zoning ordinance requires a set-back of 12 feet from the curb in a central business district. In order to install a ramp to the front entrance of a pharmacy, the owner must encroach on the set-back by three feet. Granting a variance in the zoning requirement may be a reasonable modification of town policy."

--DOJ Title II Technical Assistance Manual

Reconstruction of an existing intersection or roadway may make it possible to reapportion the right-of-way width between street, sidewalk, and landscaping elements or even to modify the street elevation or curbface height to improve access (SEE FIGURES 2 AND 3). Where sidewalk width is inadequate or sidewalk cross slope is excessive, the adjacent street may have sufficient width to borrow for sidewalk expansion. Some traffic-calming measures (bulbouts and curb extensions, for example) can also produce extra sidewalk width (SEE FIGURE 4). Increased walkway width can better accommodate curb ramps and landings at pedestrian crossings. Where the full width of a sidewalk cannot be altered to meet cross slope requirements, it may be possible to blend in a complying passageway within it.

3.2.2 Running Slope

On a new site, a knowledgeable designer can often manipulate cut and fill, entrance location, and approach direction and length to limit walkway running slope to 1:20 (5%), adding, where necessary, ramped segments with handrails and landings at or below the 1:12 (8.33%) slope specified in accessibility standards for ramps. These slopes will not be consistently possible to achieve along public sidewalks and shared-use paths, where running slope is tied to roadway gradient and underlying terrain. Nevertheless, running slope should be kept to the minimum feasible consistent with these factors. Artificial slopes should not be added as landscaping features, nor should meandering walkways that add significantly to the travel distance be permitted on a primary circulation route.

Level runouts can provide access to entrances located along sloping sidewalks (SEE FIGURE 6). Alternatively, a wider sidewalk can accommodate the blending room necessary for a transition to the level landing required at entrances. Parallel ramps may also be used to provide access to existing raised entrances constructed originally with steps (SEE FIGURES 7 AND 8). Stairs may connect diverging sidewalk levels, as long as a stair-free route is also available.

3.2.3 Cross Slope

Excessive cross slope is a major barrier to travel along sidewalks for pedestrians who use wheelchairs and scooters, pedestrians who use walkers and crutches, pedestrians who have braces or lower-limb prostheses, and those

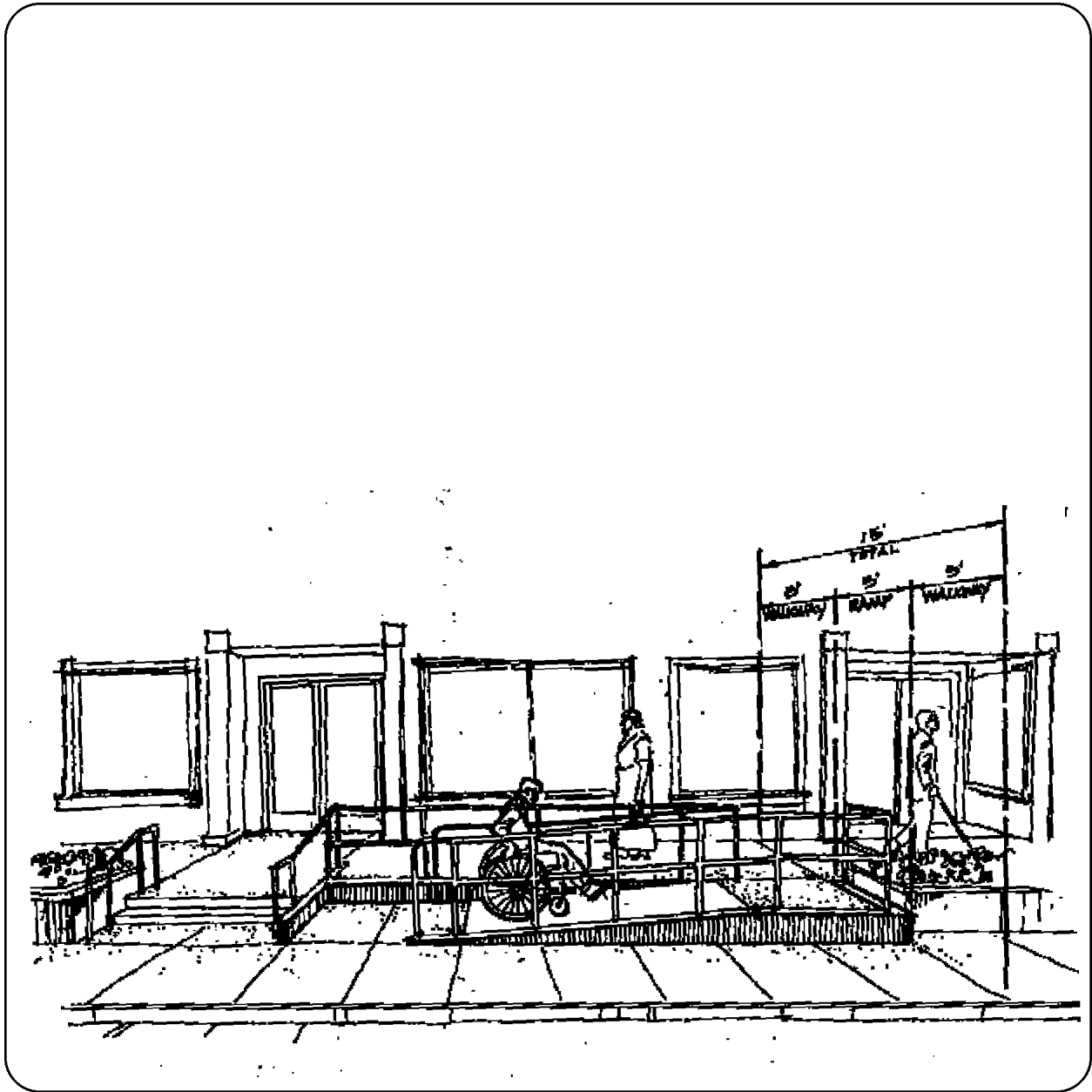

2

Removing entrance barriers

A setback of as little as 15 feet (4.5 m) can provide continuous street- and shop-level access where existing buildings are constructed with entryway steps. A more generous frontage can accommodate landscaping and site furnishings. Ramps and stairs link the two levels.

**3****Downtown Improvement Program: Auburn, AL**

This ambitious streetscape program incorporates an upper level sidewalk to eliminate steps at shop entries. Brick and stone retaining walls enclose ramp and stair access between upper shop and lower street level sidewalks. Landscaping, benches, and lighting are located in the intermediate space

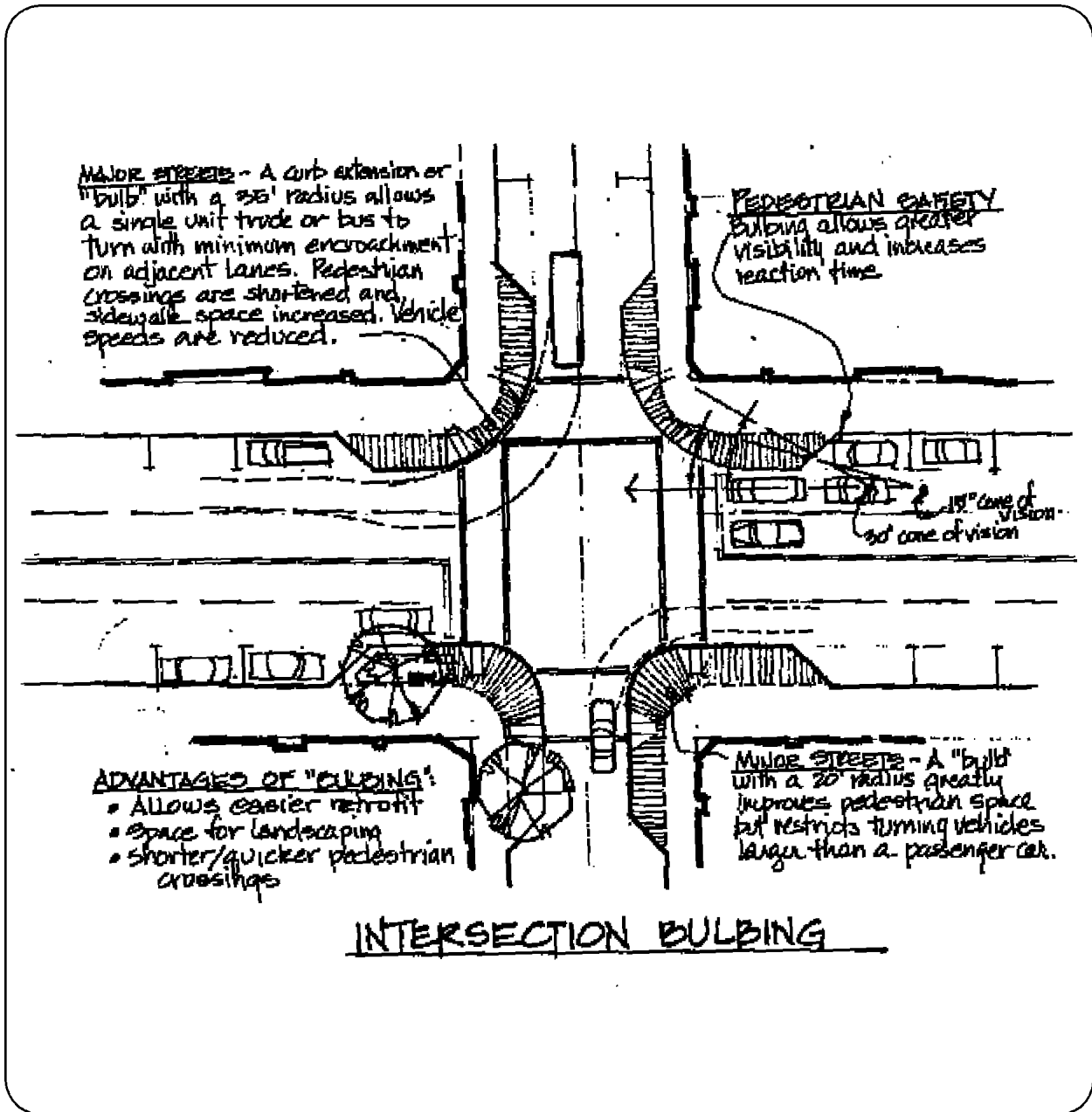

4

Ramp retrofit for existing inaccessible sidewalks

A neckdown or bulbout can 'borrow' level area from the parking lane along the street to provide the space necessary for perpendicular curb ramps—with landings—at intersections. Paired ramps can then be easily provided, even in narrow sidewalks. Neckdowns have traffic calming benefits and shorten crossing time and distance for pedestrians while improving visibility for both drivers and pedestrians.



5

Split sidewalk: Washington, DC

Where sidewalks slope steeply, a level extension of the walkway can provide accessible entrances. Steps reconnect diverging sidewalk levels.

**6****Building entrance ramp: Washington, DC**

Where sidewalk widths exceed 8 feet, an exterior access ramp parallel to the building facade may be added to provide an accessible entrance. Curbs or low walls and railings will help make ramp/stair locations detectable.

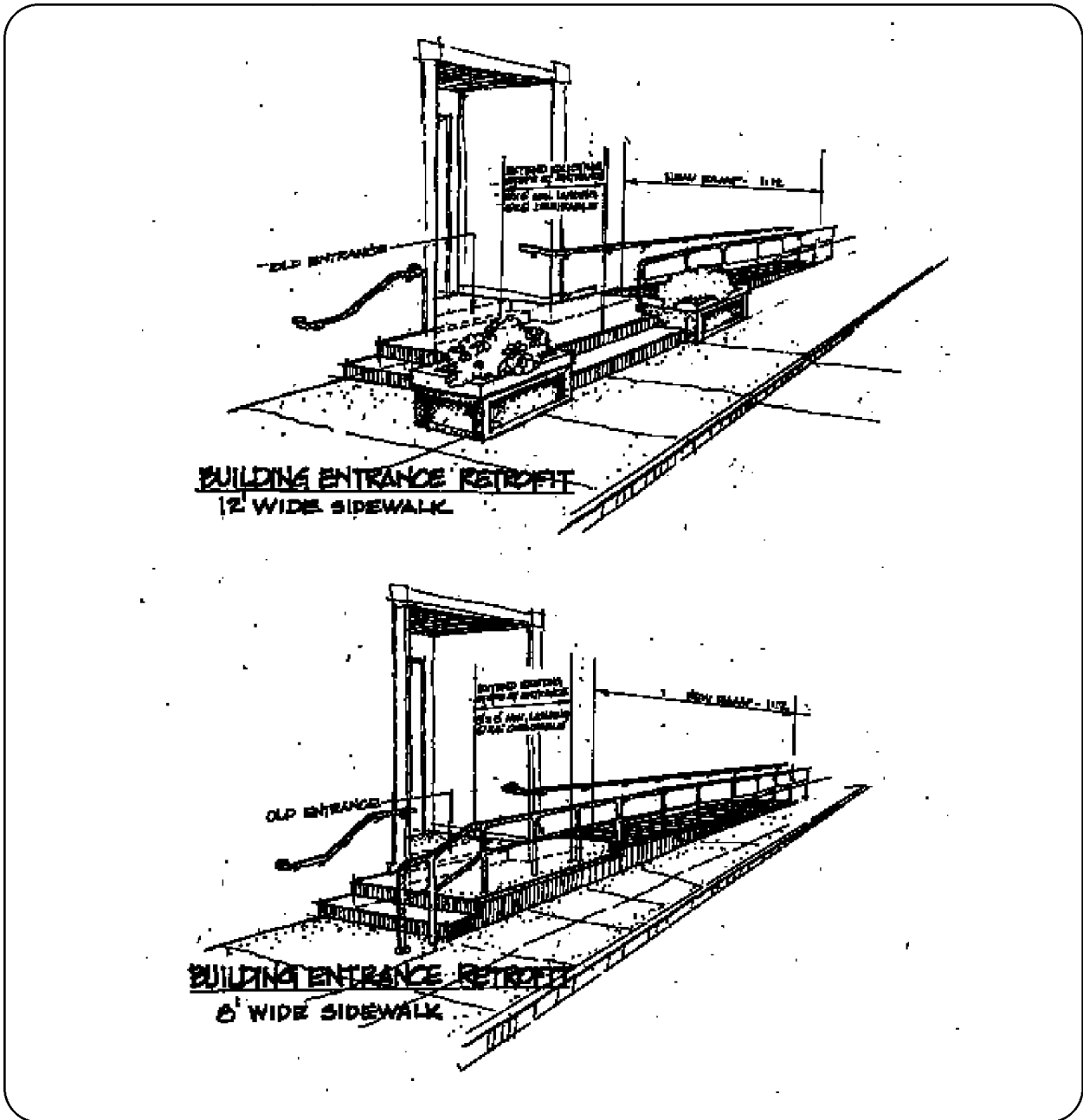

7

Building entrance ramp retrofits

Note that new ramp and stair handrails should extend beyond the ramp or stair run a distance of 12 inches (305 mm). The bottom extension at stairs should be the width of one tread plus 12 inches (305 mm) to provide support during the transition to a level surface

ADAAG Appendix: A4.5 Ground and Floor Surfaces.

Cross slopes on walks and ground or floor surfaces can cause considerable difficulty in propelling a wheelchair in a straight line.

The Australian accessibility standard permits a maximum crossfall of 1:100 along access routes in the public way.

with gait, balance, and stamina impairments. Energy that might otherwise be used in forward travel must be expended to resist the perpendicular force of a cross slope along a travel route. Cross slopes that exceed 1:48 (2%) significantly impede forward progress on an uphill slope and compromise control and balance in downhill travel and on turns. Because the cross slope of a sidewalk is typically toward the roadway, the pedestrian who loses traction or balance will be directed toward the street. In wet or freezing weather, travel across a slope always carries the threat of sliding into the roadway (SEE FIGURE 8).

Pedestrians who use crutches are particularly susceptible to cross slope when they are traveling downhill. Children, including children with disabilities and those using bicycles and other wheeled toys, are primary users of sidewalks in residential areas and are significantly less able to compensate for cross slope than adults.

Driveway aprons in residential subdivisions where narrow sidewalks are immediately adjacent to the curb are the most frequently encountered example of excessive cross slope along a pedestrian route. A level area with minimal cross slope is necessary for accessible passage across a driveway. Driveway aprons that are constructed like ramps, with steep, short side flares, can render a section of sidewalk impassable, especially when encountered in series, as in residential neighborhoods. Compound cross slopes, such as those that occur at the flares of a driveway apron or curb ramp, may cause tipping and falling if one wheel of a chair loses contact with the ground or the tip of a walker or crutch cannot rest on a level area (SEE FIGURE 9). A walker must have a flat plane to rest on if it is to provide adequate support. Wheelchair users whose upper trunk mobility is limited can be thrown from their seats by differentials in cross slope occurring over a small distance. Manual chairs, although more maneuverable than battery-heavy power chairs, are much more likely to tip on compound slopes. When this happens, it is difficult to recover control, direction, and traction.

Several design approaches are possible to achieve a complying apron, including a retrofit treatment for existing driveways that ensures a passageway across the opening that does not exceed cross slope limits (SEE FIGURES 10 AND 11).

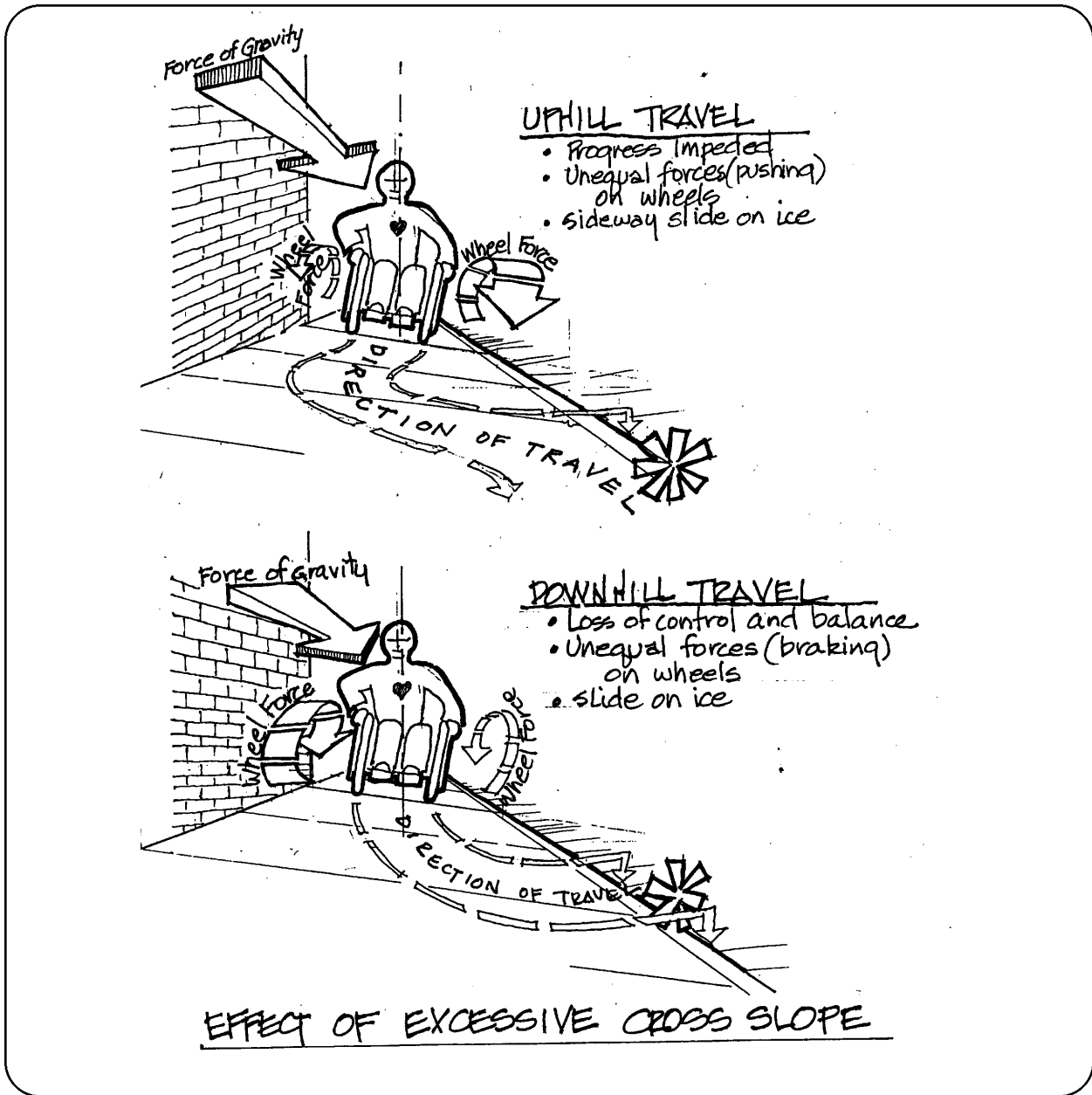

8

Cross slope

Sidewalk cross slope should be limited to 1:48 (2%). Pedestrians who use manual wheelchairs and walking aids must expend additional effort to counteract the effects of cross slope. This is particularly difficult when the sidewalk running slope is steep. Narrow sidewalks are especially hazardous, since they require maneuvering at or near the curb.

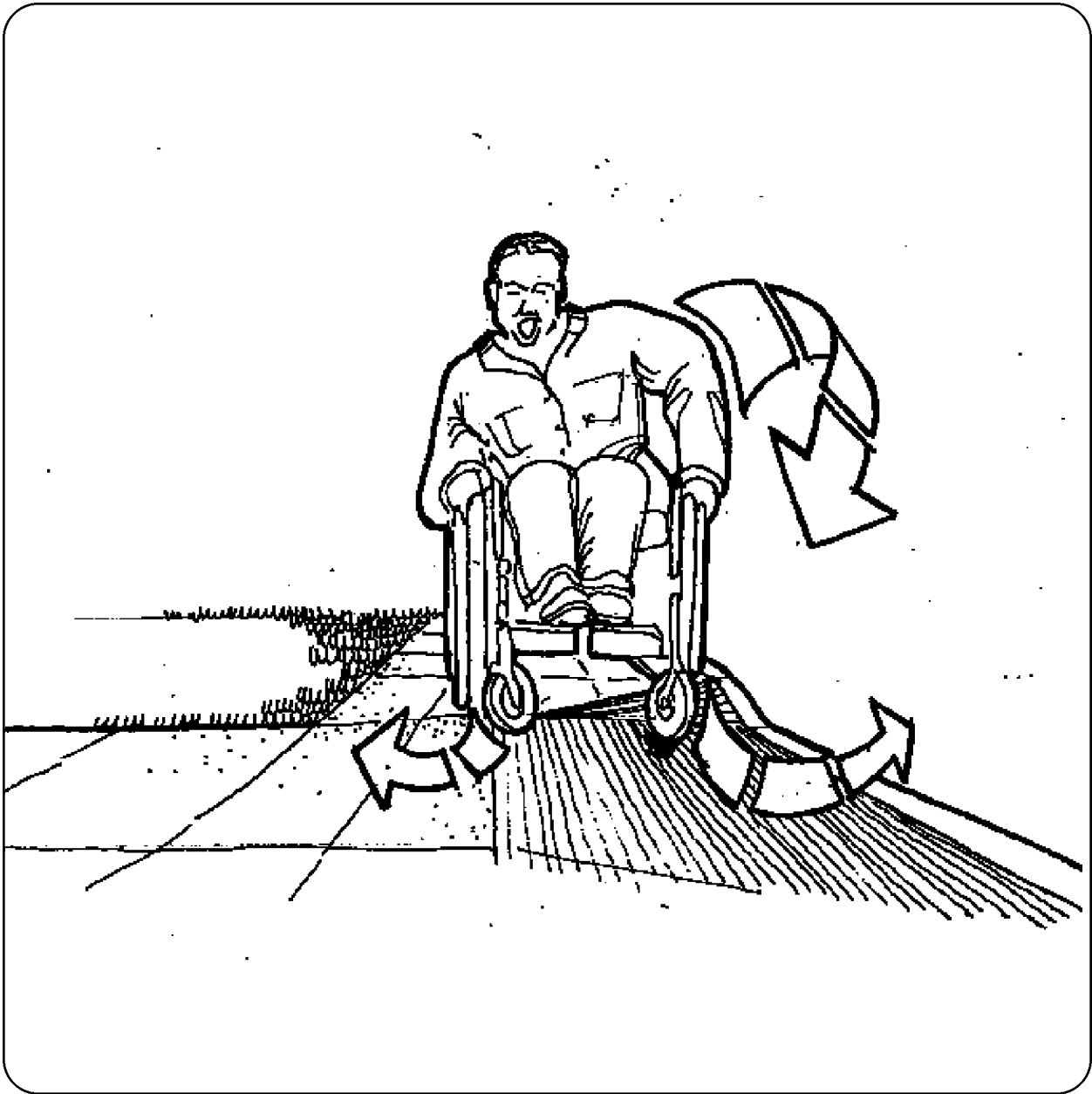

9

Compound slope

A wheelchair or walker needs a planar surface for travel. Where a drive wheel, caster, or leg tip loses contact with the surface, control and stability are at risk. Such locations include the side flares of curb ramps or driveway aprons where a level landing has not been provided or curb ramp approaches that are not perpendicular to the running slope of the ramp.

A California homebuilder submitted details illustrating how driveway aprons in narrow sidewalks at the street edge can be limited to a 1:48 slope to the street by ramping the sidewalk down to a lesser curb height before it crosses the driveway. A substantial lip at the gutter will help manage storm water and minimize the difference in elevation that must be ramped. Where bicyclists or residents with disabilities may use driveway aprons in the absence of sidewalks, a lip is not recommended.

Walkways that curve tightly while sloping are also problematic, requiring constant stroke or gait adjustment. Sidewalk intersections in hilly terrain should be planned to avoid excessive cross slope toward the street. Where sidewalks of excessive cross slope are being reconstructed, it may be possible—if there is sufficient width—to provide a 36-inch-wide (915-mm) continuous routing with a complying cross slope within the overall sidewalk width, blending adjacent surfaces to meet it.

Where accessible sidewalks intersect at a corner, a level landing (1:48 or 2% in each travel direction) should result. Limiting cross slope requires careful attention to walkway design and construction to maintain positive drainage. Because the range-of-finish tolerance is greater in the right-of-way environment than in building and facility construction, it is particularly important that contractors work to the 1:48 (2%) maximum to ensure a usable result.

3.2.4 Surfaces

Sidewalks and shared-use paths should meet the "...stable, firm, and slip-resistant..." criteria established in accessibility standards. The Access Board's "Technical Assistance Bulletin #4: Surfaces" contains additional information on the performance requirements for walking surfaces on an accessible route.

In extremes of climate, where wet or freezing conditions occur frequently, surface water must be carefully controlled and maintenance must be emphasized in both the vehicular and pedestrian way. Salted or broom-finish concrete provides good slip resistance; a broom finish is also useful in channeling runoff across a walkway.

Where unit pavers are installed, it may be difficult to achieve positive drainage within the 1:48 (2%) cross slope recommended for sidewalks and shared use paths. For these surfaces, permeable or open joints may be necessary to control ponding. Some specialty pavings are not suitable for sidewalks, although they may have applications along walkways—or portions of walkways—not required to be accessible. Split-face stone units, cobblestones, and similar irregular surfaces are not easily traversed by pedestrians who have mobility impairments and may catch a dragging foot or trigger a painful spasm in response to repeated jarring in some wheelchair users. Nevertheless, some textured walking surfaces can provide useful cues to

SURFACES

- ✓ stable, firm, slip-resistant
- ✓ 1/4" (6 mm) maximum vertical change in level; (1/2" [13 mm] if beveled)
- ✓ 1/2" (13 mm) maximum gratings/gaps in direction of travel
- ✓ 2-1/2" (65 mm) maximum gap at rail flangeway in transportation facilities

In Holland, MI, the public works department installed a snow-melting system beneath sidewalks, streets and parking lots in the downtown core as part of a Main Street revitalization program.

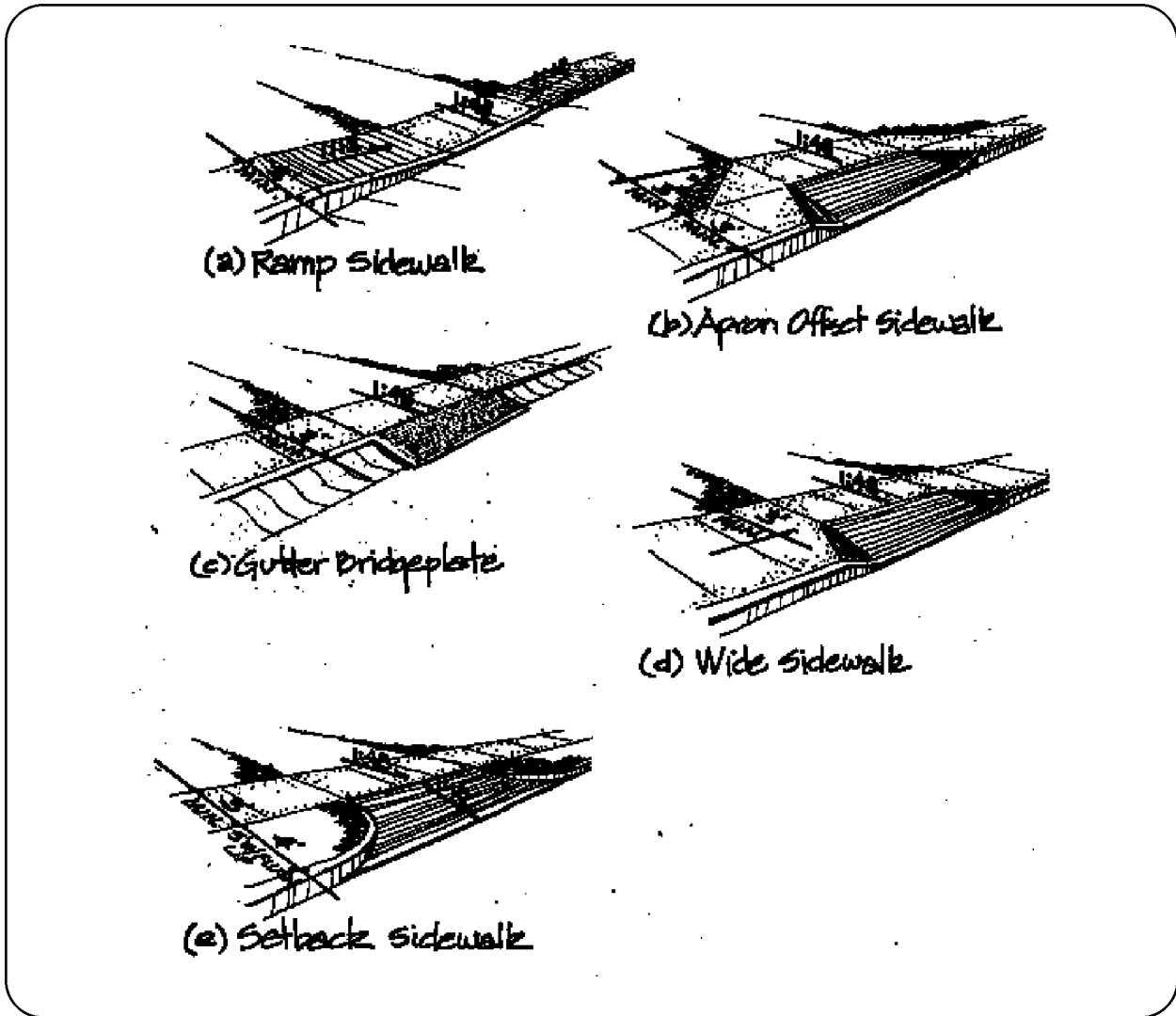

10

Driveway aprons

Excessive cross slope on driveway aprons can be a significant barrier to sidewalk use. Even with narrow sidewalks along the curb, it is possible to design a sidewalk to pass across the driveway apron without exceeding the 1:48 (2%) cross slope limitation.

- (a) A curbside sidewalk can be ramped down to a driveway apron at street level.
- (b) A sidewalk can be offset to provide a 36-inch (915 mm) width across the top of the apron
- (c) The lower rise of rolled curb sections may be useful in minimizing sidewalk setback requirements in residential developments, but may require a bridgeplate at the gutter for vehicle use and similar construction at street crossings
- (d) A wider sidewalk may narrow to 36 inches (915 mm) across the driveway.
- (e) A setback of 48 inches (1220 mm) will allow the sidewalk to clear a 1:10 (10%) apron if there is a 1/2" (13 mm) lip at the gutter to minimize the vertical change that needs to be ramped.

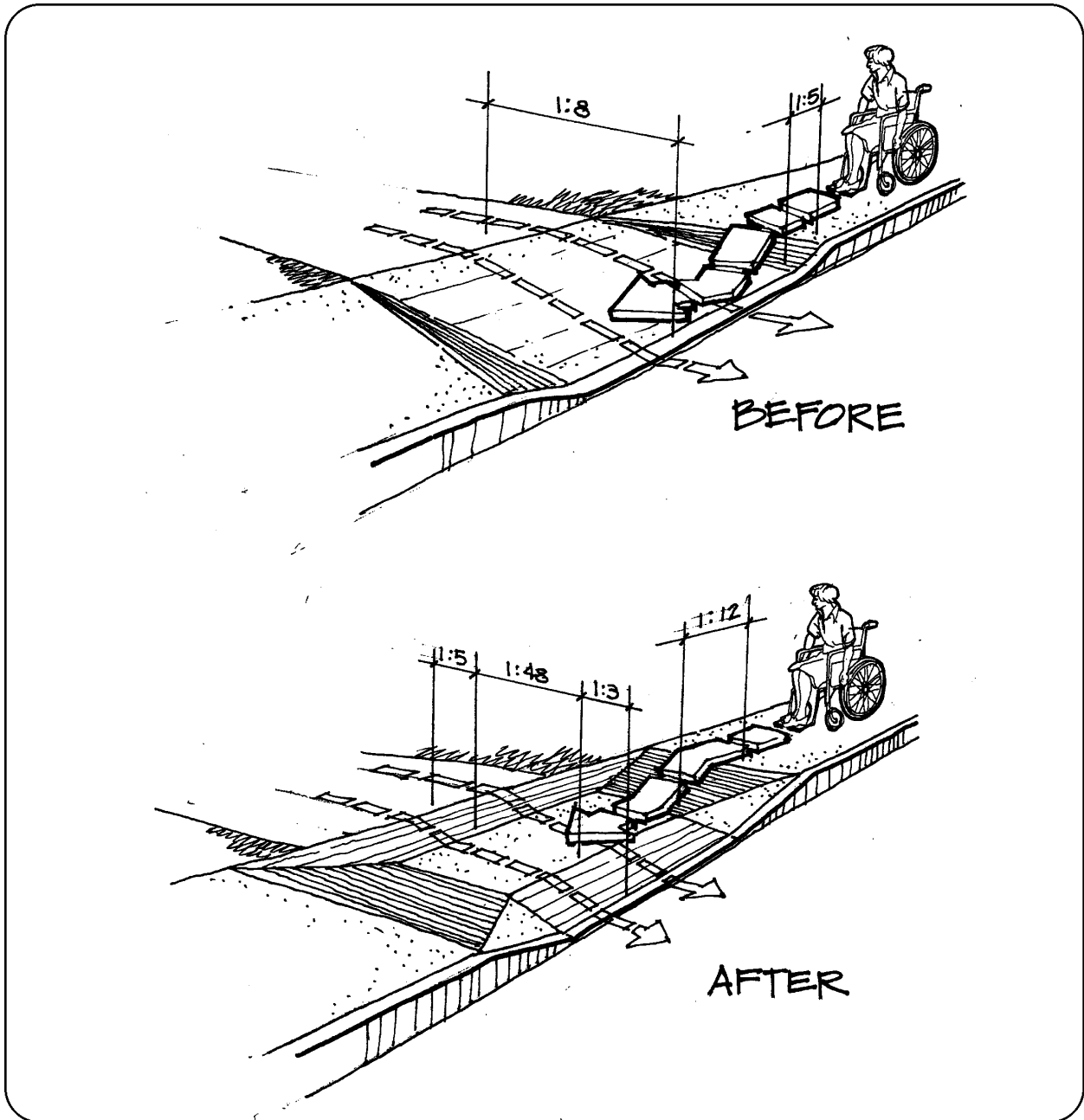

11

Driveway/sidewalk retrofit

Existing non-complying aprons can be reconstructed to achieve a usable cross slope for a width of 36 inches (915 mm). Cars must slow to negotiate the two steeper ramps on either side of the sidewalk crossing, but will not “bottom out” at these angles.

Canada's National Research Council has successfully tested a conductive concrete mix that stayed ice- and snow-free through Ottawa's 1997 winter season. Materials scientists anticipate applications to airport runways, bridges, sidewalks, and curb ramps. Production and heating costs are reported to be modest.

ADAAG Appendix: A4.5 Ground and Floor Surfaces.

People who have difficulty walking or maintaining balance or who use crutches, canes, or walkers, and those with restricted gaits are particularly sensitive to slipping and tripping hazards. For such people, a stable and regular surface is necessary for safe walking, particularly on stairs. Wheelchairs can be propelled most easily on surfaces that are hard, stable, and regular. Soft loose surfaces, such as [...] loose sand or gravel, wet clay, and irregular surfaces such as cobblestones can significantly impede wheelchair movement.

ADAAG 4.5.4 Gratings.

If gratings are located in walking surfaces, then they should have spaces no greater than 1/2 in (13 mm) wide in one direction [...]. If gratings have elongated openings, then they shall be placed so that the long dimension is perpendicular to the dominant direction of travel.

pedestrians who are blind when such materials are used as borders and edges of walkways and street crossings. Standardization and consistency in use are important for effective communication of right-of-way information. The wide range of surface textures commonly encountered on sites and public sidewalks, however, makes it difficult for blind pedestrians to derive a particular meaning from a difference in a commonly-used pattern or material. Exposed aggregate finishes have been found to be slippery when wet and are not recommended for sloping surfaces. Incised or imprinted patterns may not be detectable underfoot or to a cane. Research has shown that the truncated dome specification in ADAAG 4.29.2 is highly detectable to blind pedestrians and can be used effectively to indicate the location of a crosswalk or to indicate the division between a walkway and vehicular way, particularly where there is no distinguishable curb. Placement is critical: materials should be installed on the pedestrian walkway or curb ramp immediately adjacent to the street. (See 3.5.1 Street/Sidewalk Detectability for additional discussion).

3.2.4.1 Gratings

Other surface features that affect accessibility include gratings and similar fittings that have horizontal openings or gaps that exceed 1/2 inch (13 mm) in the direction of travel. Such gaps can capture the small front wheel of a wheelchair or the end of a crutch, suddenly stopping forward progress and possibly leading to a tip or fall. Additionally, the frame angles in which access covers and gratings are set often result in significant gaps when installed in a sidewalk.

Metal gratings are of particular concern to pedestrians who use walking aids. When wet, the grids can be extremely slippery, and the elongated openings can become a sliding track for the tip of a crutch or cane. Slip-resistant finishes or nonmetallic materials are available at additional cost for installations where the location or extent of exposed gratings may pose a problem for pedestrians, such as on pedestrian bridges and overpasses.

Where possible, gratings and similar sidewalk fittings should be located off the travel path. Note, however, that tree gratings—unless part of the pedestrian circulation route—need not meet surfacing provisions.

3.2.4.2 Gaps

Flangeway gaps at rail crossings, particularly where light rail lines are integrated into a street or a pedestrian mall, are a growing accessibility concern. Where the accessible route in a transit station must cross a track,

ADAAG 10.3 Fixed Facilities and Stations. 10.3.1 New Construction.

New stations in rapid rail, light rail, high speed rail, and other fixed guideway systems [...]

(13) Where it is necessary to cross tracks to reach boarding platforms, the route surface shall be level and flush with the rail top at the outer edge and between the rails, except for a maximum 2-1/2 inch gap on the inner edge of each rail to permit passage of wheel flanges. [...] Where gap reduction is not practicable, an above-grade or below-grade accessible route shall be provided.

"Public entities must maintain in working order equipment and features of facilities that are required to provide ready access to persons with disabilities. Isolated or temporary interruptions in access due to maintenance and repair of accessible features are not prohibited."

--DOJ Title II Technical Assistance Manual

accessibility standards permit the inner flangeway gap at the rail to be no more than 2-1/2 inches (63 mm). If the gaps are larger than that, an over- or underpass is required. Even this dimension, however, may be problematic. There have been numerous reports from pedestrians who use wheelchairs describing circumstances in which the small front wheels of a manual chair dropped into a flangeway gap and could not be extricated. Even the larger wheels of a power chair can swivel and drop sideways into a gap of this dimension, especially if the rail is raised above the surrounding surface. Rail lines that carry freight cars may need as much as a 4-inch (100 mm) flangeway to avoid train derailings. Flangeway fillers that are currently available do not hold up at the weights and speeds of travel common on freight systems, but may be acceptable on lines that serve only light rail vehicles.

3.2.4.3 Maintenance

Sidewalk surfaces that have settled or heaved over time can be a significant barrier for pedestrians. Surfaces that are smooth and rollable when newly installed may not stay that way, particularly where masonry units are installed without an adequate subbase. Knowledgeable design, wise material selection, good construction practices, and regular maintenance procedures can help ensure that differences in level between adjacent units do not exceed the limits of usability. Surface provisions for an accessible route limit allowable vertical differences in level between abutting surfaces to no more than 1/4 inch (6.5 mm); if bevelled at 1:2, a 1/2-inch (13-mm) difference in elevation is permitted.

Although it may not be feasible to meet new construction criteria consistently along older sidewalks, agencies and entities responsible for sidewalks should note that the DOJ regulation includes requirements for the maintenance of accessible features. Public works departments should respond quickly to citizen reports of damaged surfaces along high-priority routes, so that pedestrians with mobility impairments do not have to seek alternate routes. A maintenance program targeted to heavily used routes and, where necessary, a snow removal program that includes clearing curb ramps at street crossings will minimize delay and inconvenience for pedestrians with disabilities.

Seattle's Bicycle and Pedestrian Coordinator administers a citizen-request improvement program to receive, prioritize, and address right-of-way problems. The process helps the city defend liability claims by documenting its response to safety and maintenance concerns.

**ADAAG Appendix: A4.4.1
(Protruding Objects).**

Service animals are trained to recognize and avoid hazards. However, most people with severe impairments of vision use the long cane as an aid to mobility. The two principal cane techniques are the touch technique, where the cane arcs from side to side and touches points outside both shoulders; and the diagonal technique, where the cane is held in a stationary position diagonally across the body with the cane tip touching or just above the ground at a point outside one shoulder and the handle or grip extending to a point outside the other shoulder. The touch technique is used primarily in uncontrolled areas, while the diagonal technique is used primarily in certain limited, controlled, and familiar environments. Cane users are often trained to use both techniques.

Australian guidelines prohibit the placement of any obstruction within the sidewalk 'walk zone', a 60-inch-wide pedestrian route between intersections.

PROTRUDING OBJECTS

- ✓ **critical zone is between 27" (685 mm) and 80" (2030 mm) above finished floor (AFF)**
- ✓ **maximum projection perpendicular to circulation route:**
 - **4" (100 mm) maximum projection from wall**
 - **12" (305 mm) maximum projection from post (if detectable at base)**

ADAAG 4.4.2 Head Room.

Walks, halls, corridors, passageways, aisles, or other circulation spaces shall have 80 in (2030 mm) minimum clear head room. [...]

Maintenance of pedestrian routes should also be considered a "program" of an entity covered by title II. Where abutters or owners of adjacent property are charged with responsibility to fund repairs or improvements or to clear snow from sidewalks, municipalities should consider how to ensure the accessibility of those routes.

3.2.5 Pedestrian Envelope

The passage along or within a sidewalk or shared-use path should be clear of obstructions underfoot, overhead, or in between. Objects that protrude over a circulation route above a height of 27 inches (685 mm) are not detectable by cane.

Objects that encroach on a travel path can be a significant hazard for pedestrians who are blind (SEE FIGURES 12 and 13). Elements below 80 inches (2030 mm) that overhang a sidewalk or shared-use path, such as awnings, banners, signs, and tree branches, and items that protrude into the sidewalk above a height of 27 inches (685 mm), including wall-mounted telephones, projecting signal boxes, and similar impediments, often are not detected by blind pedestrians who use a long cane to travel independently. In contrast, street furnishings with a leading edge below 27 inches (685 mm)—benches, bus stop enclosures, sign poles, and signal and lighting standards—can be more easily identified and avoided.

Wall-mounted elements at or above 27 inches (685 mm) should be limited to a 4-inch (100-mm) projection into any travel route. Although post-mounted items are permitted to overhang a support by 12 inches (305 mm) because the post itself should be detectable at its base, many pedestrians who are blind question the rationale for this provision. These pedestrians assert that post-mounted items are no more detectable than those that are wall-mounted and, thus, should be limited to the same 4-inch (100-mm) dimension.

A straightforward and predictable routing along a sidewalk, where equipment, street furniture, landscaping, and utilities are grouped together in a zone along the curb, will facilitate travel by pedestrians who have vision impairments. Note, however, that large open areas that do not have detectable landmarks, traffic sounds, or vertical facades that reflect sound may not offer sufficient cues for orientation and wayfinding. Where a corner lot is occupied by a park, parking lot, or building setback, it may be helpful to provide a raised curb or a grass or planted edge as a shoreline for cane travelers.

**12****Protruding objects**

The route along a sidewalk has a vertical dimension as well as a horizontal one. Items that project from walls and poles and landscaping that extends over or into the circulation route may not be detectable by pedestrians with vision impairments.

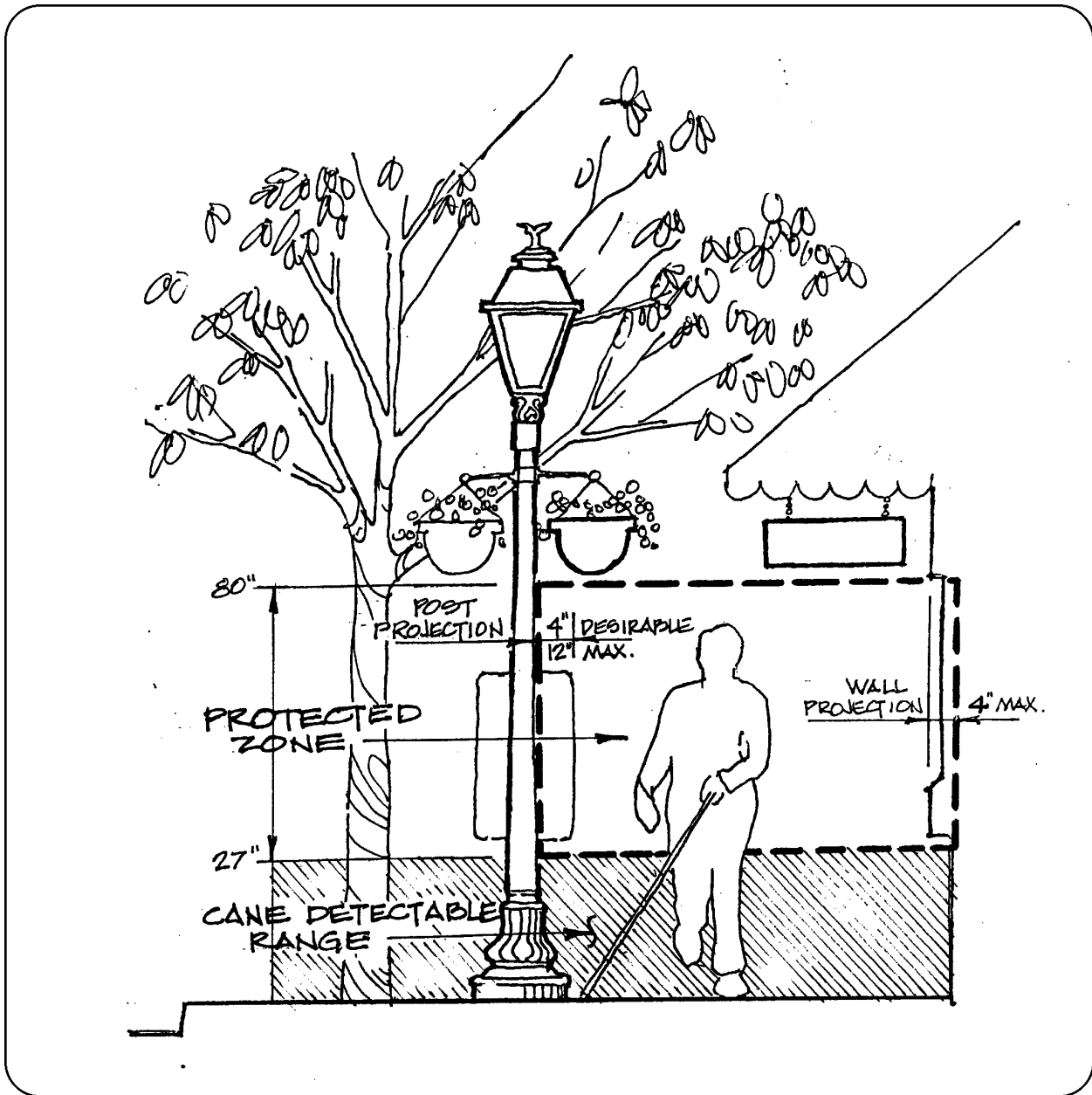

13

Protruding objects

Items that protrude into a circulation route can be hazards for pedestrians who are blind. Wall-mounted telephones, post-mounted drinking fountains, handrail extensions, and other projections along a sidewalk will be detectable by cane if the leading edge is at or below 27 inches (685 mm). Eighty-inch (2030 mm) headroom should be provided at signs and awnings. Tree branches should not encroach below this level.

STREET CROSSINGS

- ✓ contrasting markings
- ✓ pedestrian signals accessible, where provided
- ✓ accessible over- and undercrossings
- ✓ detectable sidewalk/street boundaries
- ✓ adequate crossing time
- ✓ paired curb ramps and landings where feasible
- ✓ accessible islands and medians

A videotape made by an orientation and mobility specialist at a suburban right-turn slip lane reveals that drivers rarely cede the right-of-way on large radius turns—even to pedestrians who are blind who are using white canes.

3.3 Intersection Design

3.3.1 Continuous-Flow Intersections

Although many traffic-calming measures now gaining acceptance in the United States will benefit pedestrians with disabilities, those who are blind or have low vision are concerned about the lack of crossing opportunities at roundabouts and unsignalized traffic circles. Visual observation is the only way to identify and select a gap for crossing at these locations. Analyzing traffic sounds is not a technique that can be effectively applied to crossings at these and other continuous-flow intersections, including many free right turn locations. Where traffic volume or speed is high, pedestrians with vision impairments (as well as children, pedestrians who have cognitive disabilities, and those who travel slowly) must often choose an alternate route that avoids such intersections. Although State white cane laws require motorists to yield the right-of-way to pedestrians crossing with white canes or service dogs, anecdotal information suggests that this rarely occurs and is not easy to enforce. The American Council of the Blind (ACB) and the Association for the Education and Rehabilitation of the Blind and Visually-Impaired (AER) have initiated research to determine how to ensure access to these types of intersections.

At unsignalized street crossings, including roundabouts, pedestrians who use wheelchairs are at a higher risk of being struck by moving vehicles because they are not easily visible to motorists, particularly where they must cross in front of more than one lane of traffic going in the same direction.

3.3.2 Geometric Design

Curb radii have gradually increased over the last several decades to accommodate the longer wheelbases of trucks and buses. This has greatly reduced the sidewalk area available for installation of signs, signal standards, control boxes, and other roadway appurtenances. Pedestrian platooning space at street corners has also been reduced. Where curb radii are large, pedestrians may be waiting in an area that lies outside a driver's field of vision.

Drivers, who are able to turn at higher speeds at these intersections, also have the advantage of time and momentum over the pedestrian waiting to cross and often fail to yield the right-of-way. Street crossings are longer

The Downtown Phoenix (AZ) Streetscape Project used a strategic visioning process to develop plans for a safe, pedestrian-friendly environment in the downtown core. Traffic calming measures included the conversion of one-way streets to two-way operation; the addition of diagonal on-street parking, and the enlarging of sidewalks at corners to accommodate pedestrians waiting to cross.

A leading pedestrian green interval (LPI) can allow pedestrians to occupy the crosswalk before cars are permitted to turn. Research in St. Petersburg, FL showed that a three-second LPI substantially reduced conflicts between pedestrians and vehicles. Where pedestrians with vision impairments receive notice of the onset of the advanced pedestrian interval by audible or tactile signals, they can initiate a crossing before turning vehicles seize the right of way—often a problem when the sound of the parallel traffic surge is used to determine the crossing interval.

The Institute of Transportation Engineers, in its proposed "Recommended Practice on Street Design Guidelines for Traditional Neighborhood Development" notes that the extra crossing distance is almost doubled by an increase in curb return radius from 10 feet to 15 feet.

where radii are large, and pedestrians who do not start at the beginning of a WALK cycle may not be able to complete a crossing in the allotted time. Those who travel more slowly or must wait to start until they can confirm the start of the pedestrian interval may be discouraged from attempting to cross at such intersections.

Stop lines, advanced to allow maximum storage space for vehicles awaiting a signal phase, give turning vehicles a significant edge over pedestrians when a light cycle changes; this encourages driver intimidation of pedestrians when turning. Cars waiting to turn right on red often block curb ramp and crosswalk access from the street or sidewalk. Pedestrians with vision impairments, whose cues to cross come from the sounds of parallel traffic, may not be able to detect or distinguish separate WALK cycles if turning vehicles regularly advance into the crosswalk, masking other cues. A delayed right turn may be helpful in such circumstances.

Smaller curb radii have traffic-calming effects, slowing driver speed at turns and giving pedestrians the opportunity to begin a crossing before the vehicle turns. The larger pedestrian platooning space at corners keeps pedestrians within a driver's field of view and shortens street-crossing distances and times, a benefit to both drivers and pedestrians (SEE FIGURE 14). For pedestrians who have vision impairments, the intersection with a smaller curb radius provides a more audible distinction between perpendicular and parallel traffic flows.

3.4 Curb Ramps

The curb ramp is the basic unit of accessibility in a pedestrian circulation network. Even on steep sites, pedestrians using motorized wheelchairs or being assisted in traveling can use curb ramps, and a connection to the street crossing should be available if there is a pedestrian walkway.

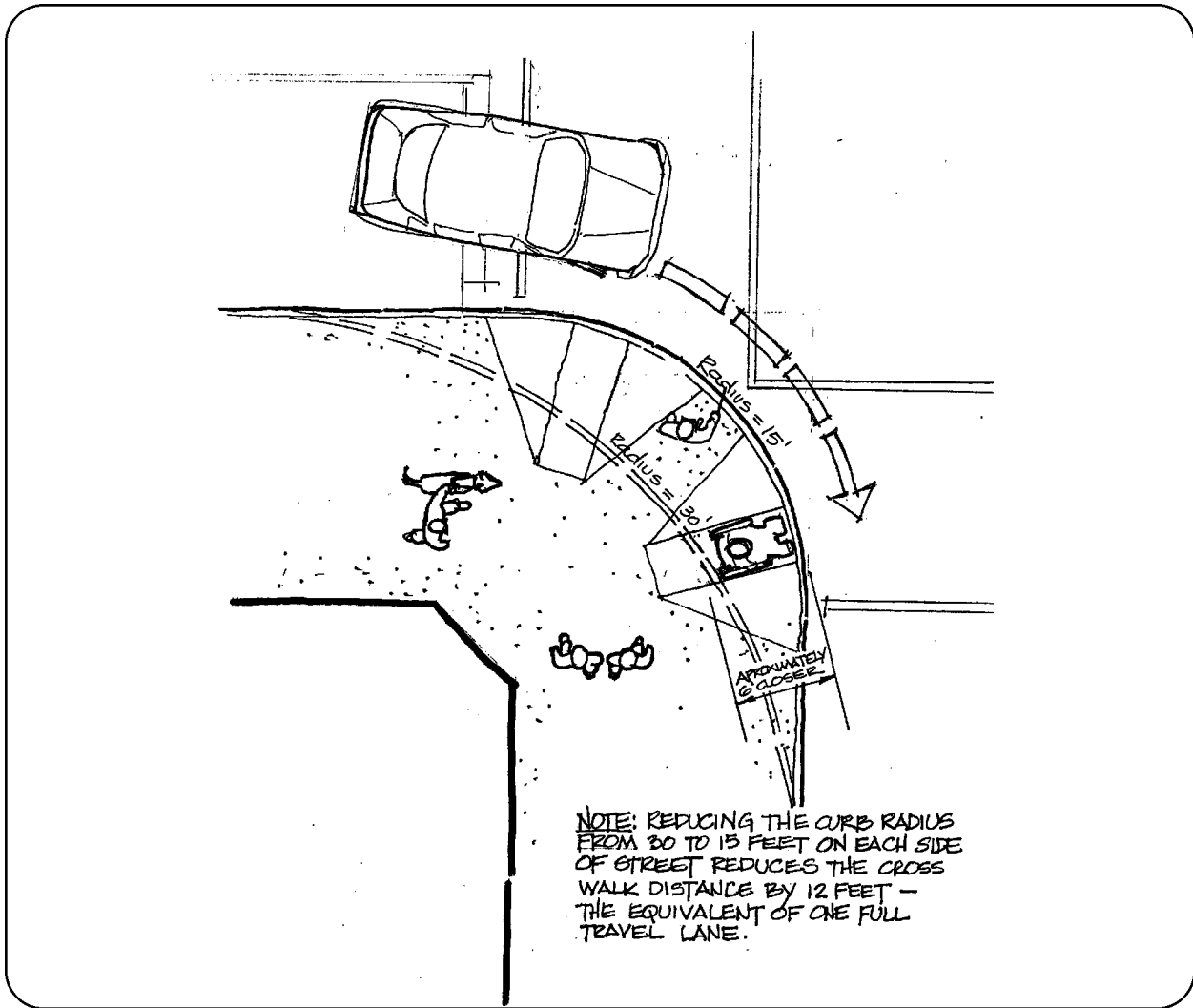

14 **Curb radius**

AASHTO's 'Green Book' on highway geometrics notes the additional pedestrian crossing distance attributable to larger curb radii. The time added to crossing between curbs increases dramatically at radii above 20 feet (6.1 m): a reduction of 15 feet (4.5 m) in curb radius will add enough space to most intersections to accommodate paired perpendicular curb ramps.

CURB RADIUS	ADDED DISTANCE FOR:		ADDED TIME (@ 3.5 FPS) FOR:	
	10' border	20' border	10' border	20' border
10'	2'-8"	---	.8 sec.	---
20'	13'-4"	5'-4"	4 seconds	1.4 seconds
30'	26'-8"	15'-4"	8 seconds	4.5 seconds
40'	41'-4"	27'-0"	12 seconds	8 seconds
50'	56'-4"	40'-0"	16 seconds	12 seconds

CURB RAMPS

- ✓ one at each crossing, where feasible
- ✓ perpendicular to curbline
- ✓ 1:12 maximum running slope (new construction)
- ✓ 1:48 (2%) maximum cross slope
- ✓ 36" (915 mm) minimum width
- ✓ level landing at top
- ✓ 36" (915 mm) long if toe room available
- ✓ 48" (1220 mm) long if constrained
- ✓ 60" (1525 mm) long if between ranges
- ✓ within crosswalk at foot
- ✓ no exposure to moving traffic lane
- ✓ 1:20 (5%) maximum counterslope at gutter
- ✓ flush (no lip) connection at street

Curb ramps are the only item of right-of-way construction specifically required in the DOJ title II regulation (see 35 CFR §35.150(c)(2) for existing facilities and §35.151(e) for new construction and alterations). Where new sidewalks or streets are constructed or existing pedestrian or vehicular ways are altered, curb ramps or other sloped areas must be provided at intersections with curbs or other barriers to use. Under program accessibility in existing facilities, the regulation also requires title II entities to install curb ramps along existing pedestrian routes that are not otherwise being altered to provide the benefits of public sidewalks to people who have mobility impairments. Many jurisdictions consider resident requests in establishing priorities for new sidewalks and identifying locations where curb ramps are required. DOJ title II regulations require that public entities give priority to providing curb ramps at walkways serving State and local government offices and facilities, transportation, places of public accommodation, and employees, followed by walkways serving other areas.

3.4.1 Types of Curb Ramps (SEE FIGURES 15, 16, 17, 18)

A curb ramp assembly should include top and bottom landings, the ramp run itself, and an edge treatment, but curb ramps need not be provided with handrails. Three basic curb ramp types are described in accessibility standards:

- the familiar **perpendicular** curb ramp (known as an inset, recessed, or returned ramp in some areas) cuts through a curb line at right angles and is located within the border width. Such a ramp may have returned edges if it is in a parkway or landscape strip but should have flared sides if pedestrians may walk across them (SEE FIGURE 15).
- the **diagonal** curb ramp, a variant of the perpendicular type (because it too cuts the curb line at right angles), is located at the midpoint or apex of the curb radius or return and serves two crossing directions with a single cut.
- the **built-up** curb ramp extends from the sidewalk and has edges that are blended down to the street surface with flared sides. Built-up ramps are a hazard to vehicles if installed in traffic lanes and do not provide edge protection for users, because their flares slope

down to the adjacent road surface rather than up to the sidewalk surface.

There are many variations of these curb ramp types. In addition, most public works plans add several other curb ramp types, including the following:

- the **parallel** or in-line curb ramp in which all or part of the sidewalk ramps down to a street crossing. Where a turn is required to make a perpendicular crossing, a landing at street level but within the sidewalk width is provided (SEE FIGURE 16).
- the **combined** (parallel and perpendicular) ramp, in which the sidewalk ramps down to a landing at a lesser curb height, thus allowing a shorter perpendicular run to connect to the street. These are useful in narrow borders (SEE FIGURE 17).
- the **semi-projected** curb ramp, a perpendicular curb ramp that extends over the gutter width, much like a built-up ramp, to gain additional run distance and height up the roadway crown (SEE FIGURE 18).

In Hilo, HI, curb ramps retrofitted along an existing sidewalk are projected through the gutter width, mitigating the effects of an excessive gutter counterslope and minimizing the rise--and therefore the run--of the ramp. This is a useful technique when adding curb ramps in an existing developed environment . Exposed edges of the ramp extension are flared back to the curb face. European variants of this type often include a vertical drainage grate in the face of the flared return.

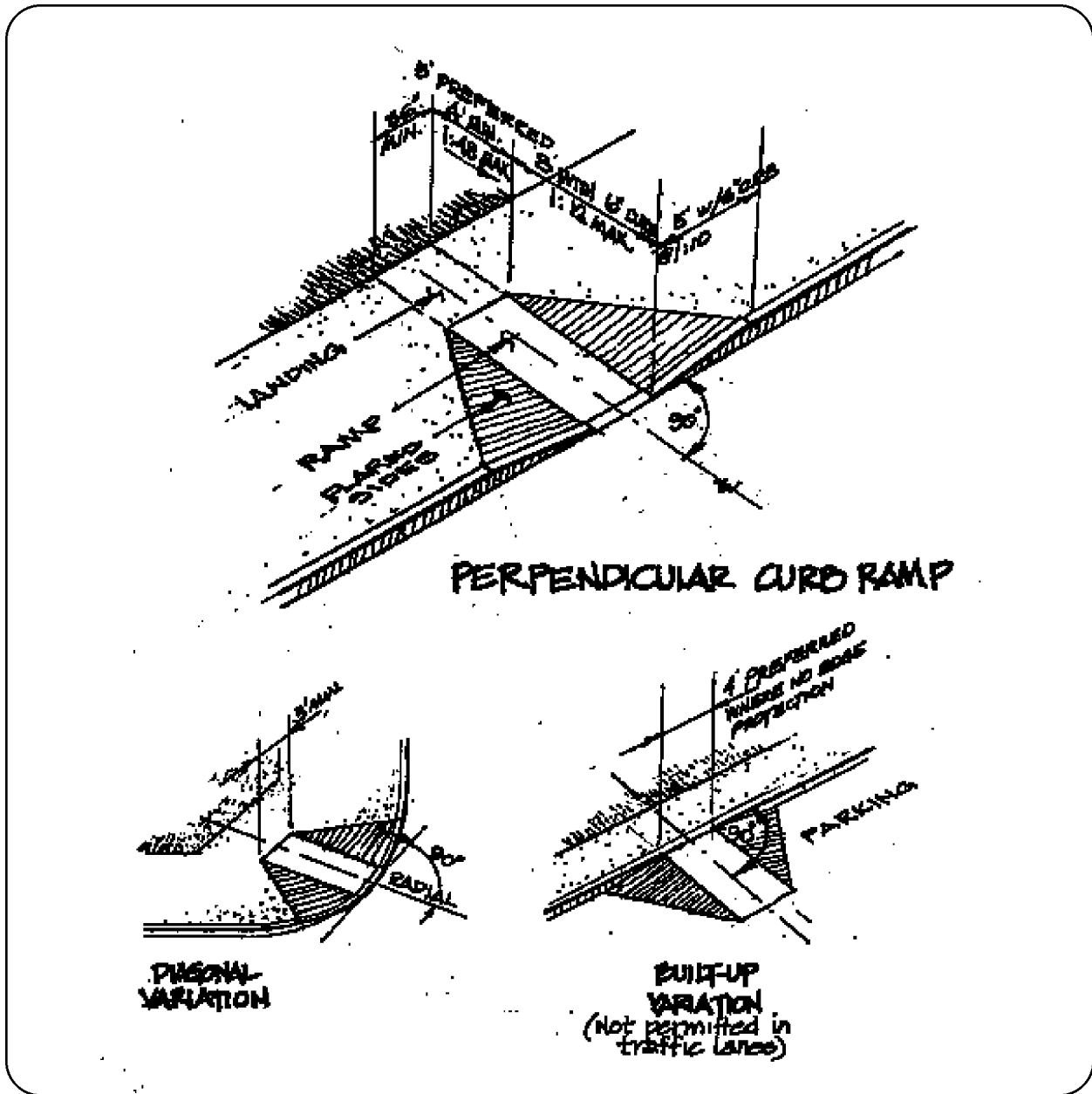

15

Perpendicular curb ramps

A perpendicular curb ramp is so named because the run of the ramp cuts the curb it crosses at a 90-degree angle). A perpendicular curb ramp may be located within the radius of a curbline. A diagonal curb ramp is a perpendicular curb ramp located at the apex of the curbline curve; a built-up curb ramp is a variant that is projected from the sidewalk rather than let into it.

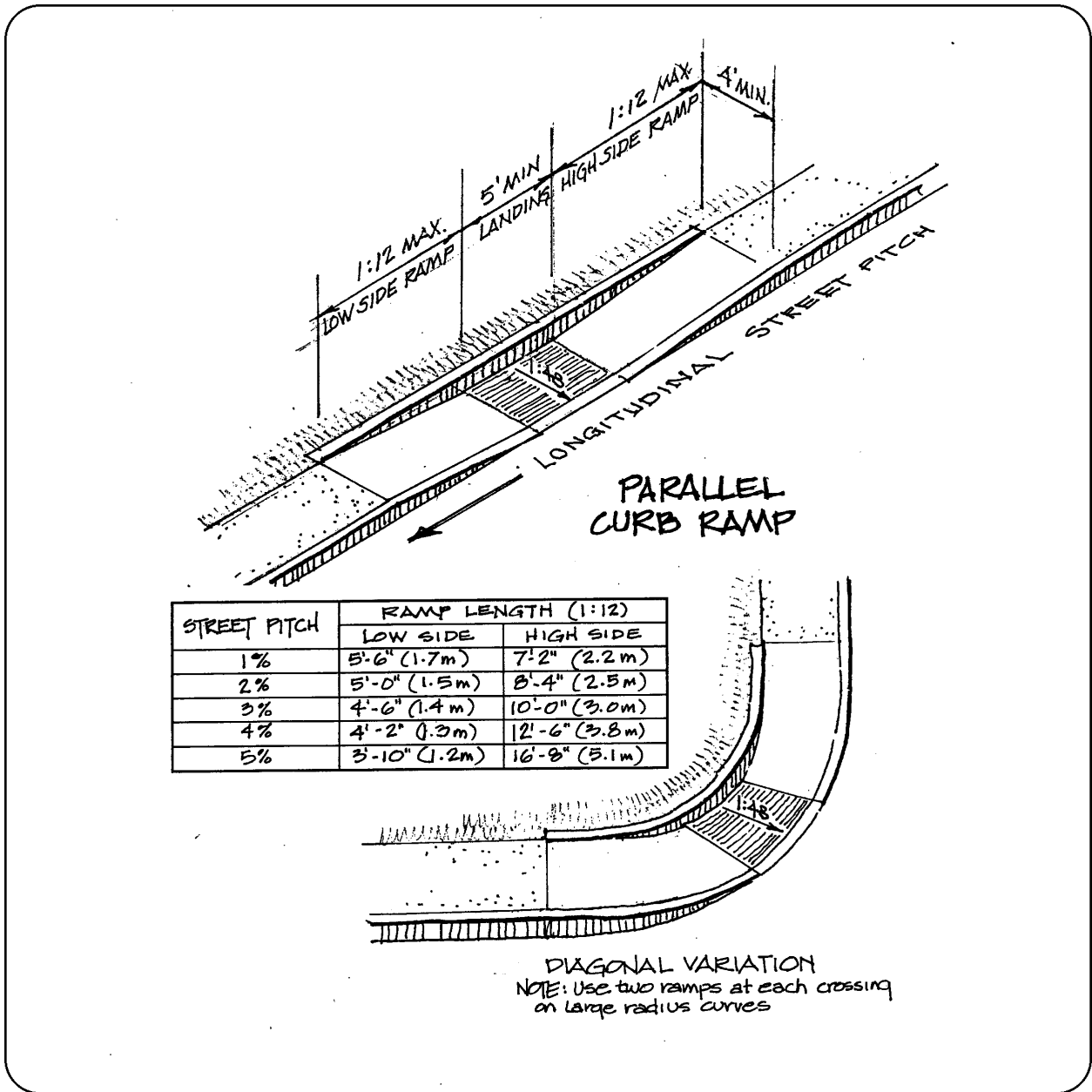

16

Parallel curb ramp

A parallel curb ramp slopes in the direction of sidewalk travel. Such ramps are useful in narrow sidewalks along the curb. The landing must be 60 inches (1525 mm) long to permit a turn into and out of the crosswalk. Like the sidewalk, the landing should not slope more than 1:48 (2%) to the street.

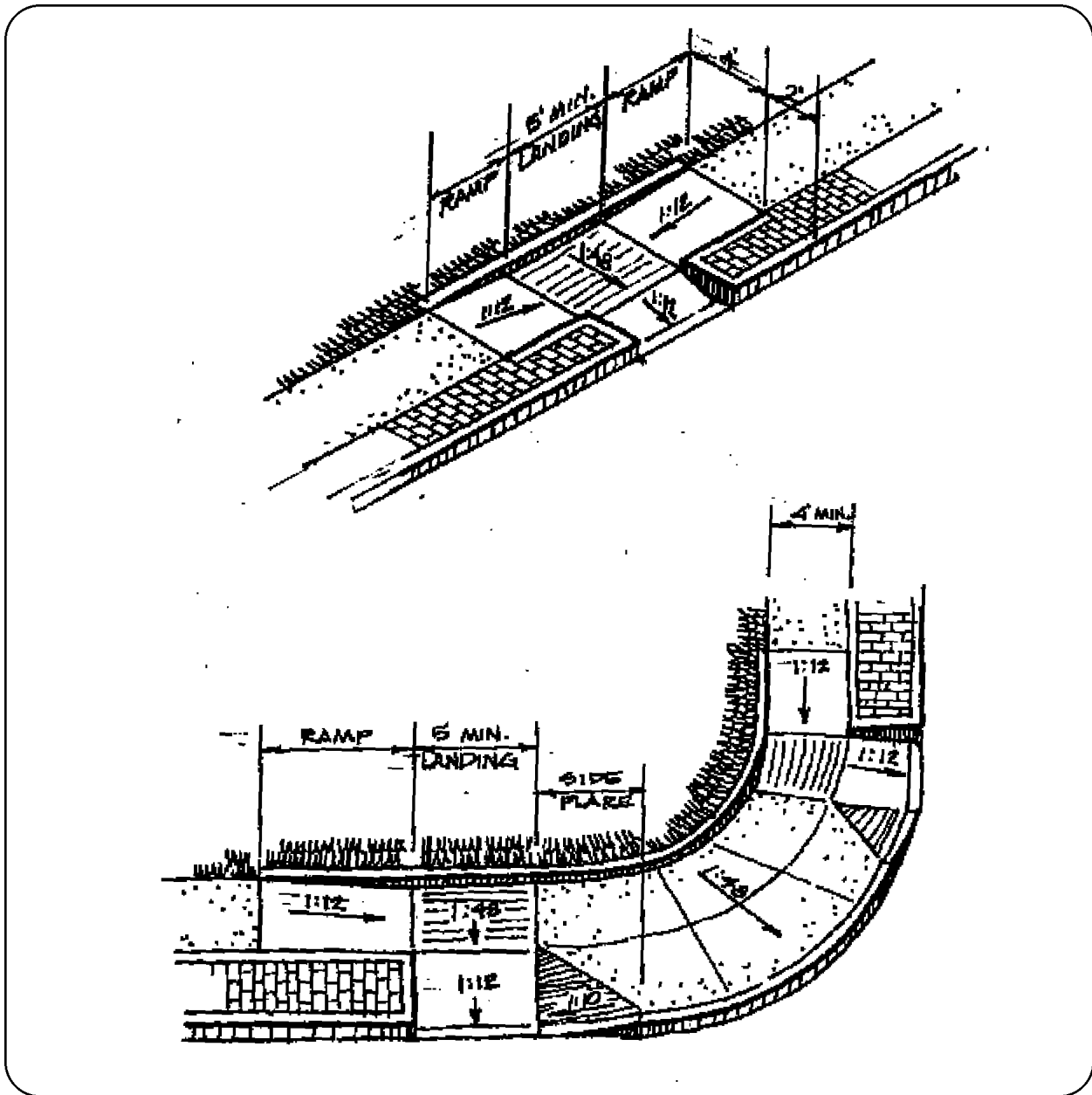

17

Combination (perpendicular/parallel) curb ramps

By using parallel and perpendicular ramps together, designers can serve narrower sidewalks without violating accessibility criteria. The short perpendicular run to the street can be protected by a landscaped setback or connected to the sidewalk with a warped surface.

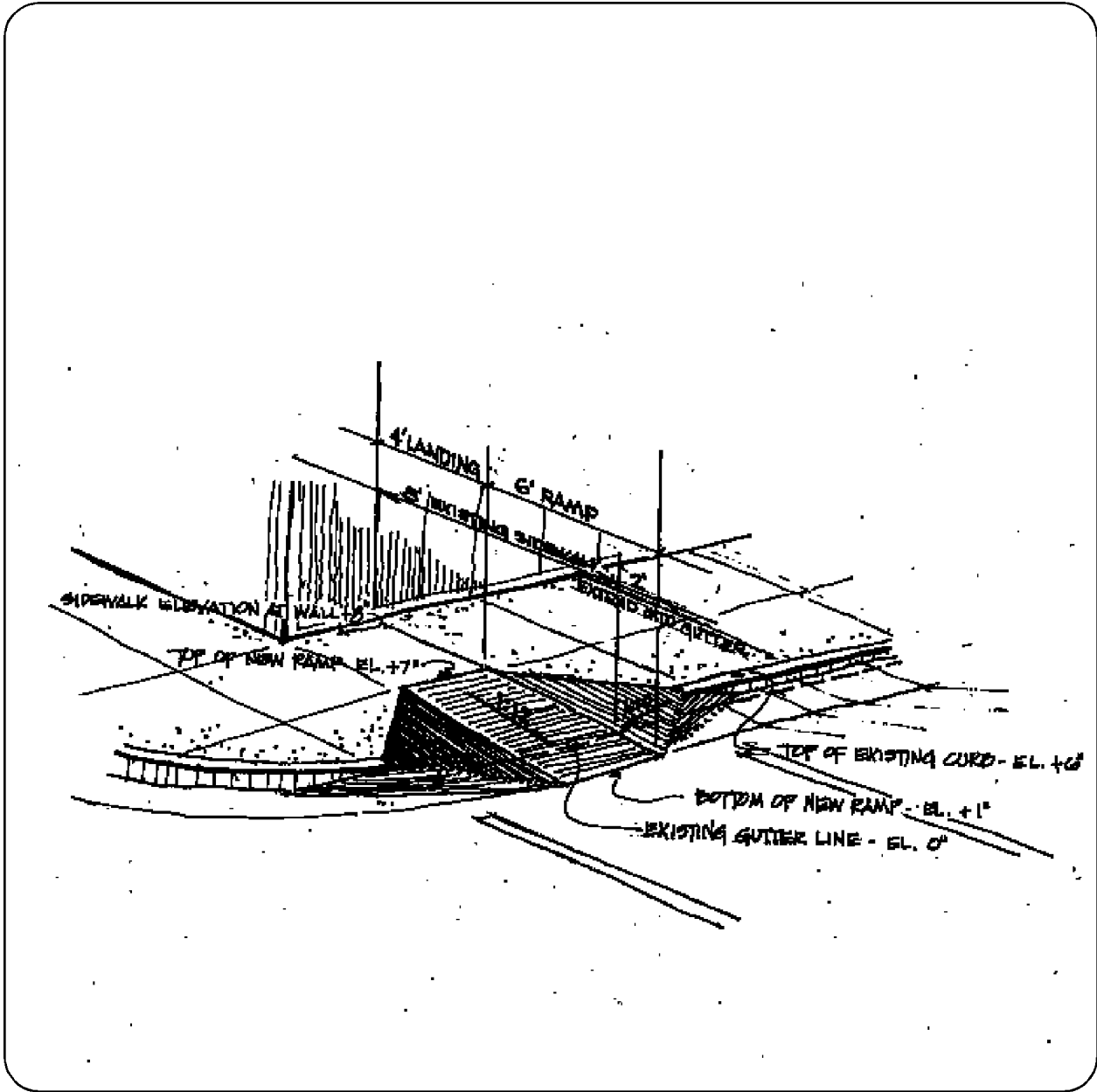

18

Semi-projected curb ramp

A curb ramp may project across the width of the gutter to add run length in a narrow sidewalk. Such an extension eliminates the transition through the gutter and keeps ponded water away from the toe of the curb ramp. Semi-projected ramps meet the street crown at a higher elevation, an additional benefit in shortening a ramp run.

3.4.2 Curb Ramp Usability Considerations

Sidewalk designers who understand the rationale behind accessibility criteria will be better prepared to evaluate the relative merits of curb ramp type, placement, landing width, slope, and cross slope when designing curb ramps along existing developed streetscapes (SEE FIGURE 19).

A pedestrian with a mobility impairment may be using a sport or standard manual chair, a three-wheeled power scooter with a front tiller, a standard power chair, or a large custom model capable of many seating adjustments. Each requires different features of a curb ramp for maximum usability, and performance differs in going up and down the ramp.

Large, heavy, power-driven wheelchairs cannot accomplish fine maneuvers in tight spaces, but they can be more stable on irregular exterior surfaces and can traverse a steep slope with little difficulty—as long as the power supply is available. Small, lightweight, manual chairs can maneuver tightly but are very unstable on cross slopes and are easily tipped backwards where ramp slopes are extreme. Such chairs are more versatile inside, however, particularly in older buildings where accessibility is limited and maneuvering space is at a premium, as in toilet rooms, on elevators, and at doors. Some three-wheeled power scooters with control tillers have large turning radii because of their longer wheelbases and are unstable on compound slopes because of their higher seats and narrow width.

For stability, it is important to approach the base or toe of the ramp straight on when ascending. Most manual chair users will take a run at an up-ramp to take advantage of forward momentum. To provide a straight shot to the top from the base at the street, the curb ramp needs to be perpendicular to the curb it cuts, so that both sides of the ramp are the same length (SEE FIGURE 20). If the curb ramp is skewed, with one side shorter than the other, it will be necessary to turn while ascending—a more difficult and taxing maneuver—or enter the ramp at an angle to the change in slope, which affects balance and compromises control. When all four wheels of a wheelchair or scooter are not in contact with the rolling surface, some of the maneuverability necessary to deal with surface irregularities and upslope—and the control necessary to manage a downslope—are lost. Because the downhill slope of a ramp usually ends in the street, a loss of control may have serious safety effects.

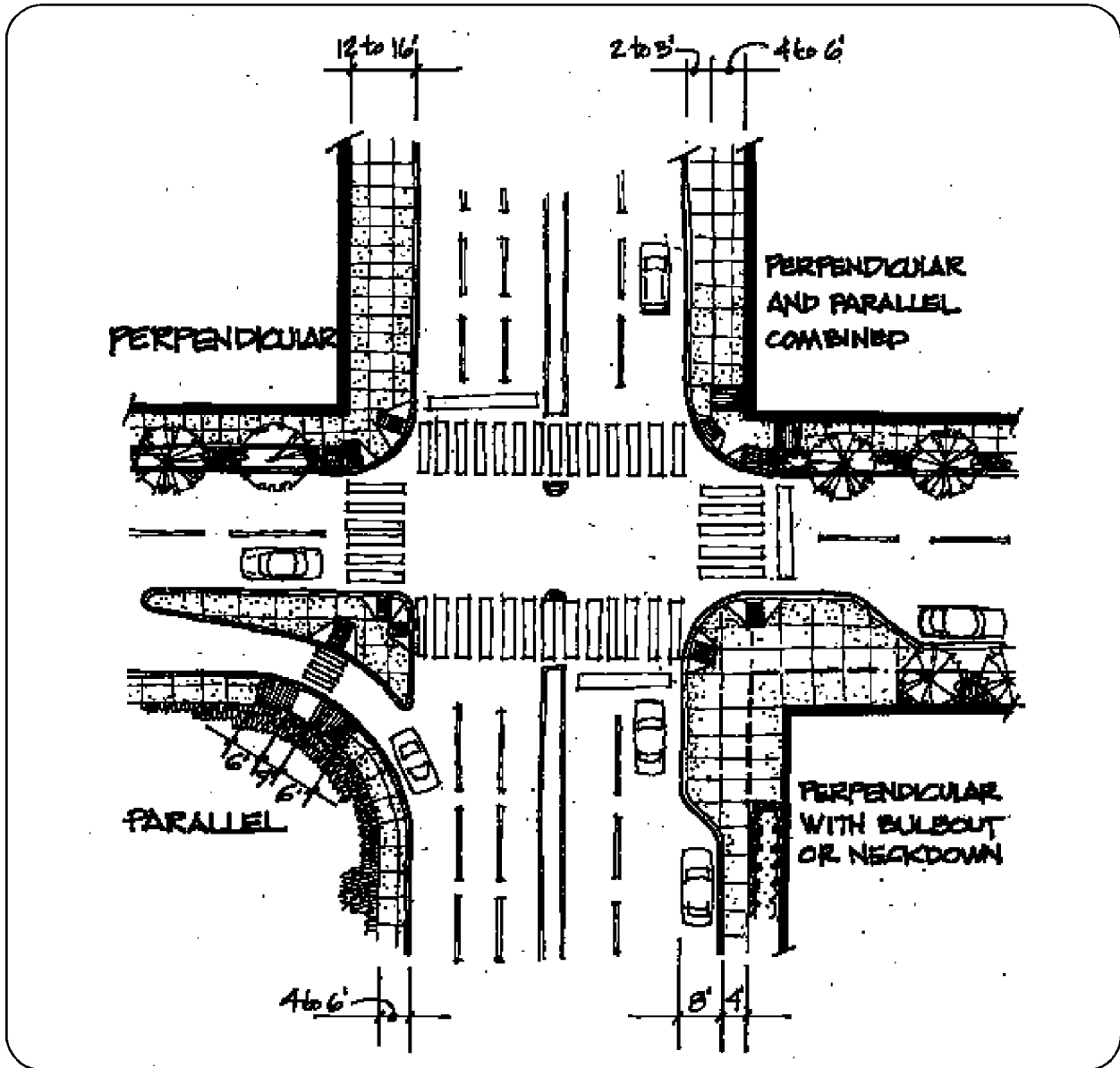

19

Curb ramp design

Curb ramp design is affected by many variables: curb height, available border width, crosswalk location, curb radius, and the placement of other elements are the major determinants. Assuming a six-inch (150mm) curb height and a 1:48 (20%) sidewalk cross slope, sidewalk widths of twelve feet (3660 mm) or more will be sufficient for a 1:12 (8.33%) perpendicular ramp run and a 48-inch (1220 mm) landing. If landscaped setbacks without cross slope are used, only ten feet ((3050 mm) of sidewalk width is necessary. Narrower border widths will not accommodate a ramp perpendicular to the curb unless the curb height is lessened. Sidewalks of three to six feet (915-1830 mm) in width will require parallel ramps, constructed by sloping the sidewalk itself down to a level landing at the crossing (the landing should slope to the street at 1:48/2% for drainage). Border widths between six and twelve feet (1830-3660 mm) can be treated with a combination ramp: a parallel ramp connecting to a level landing with a short perpendicular run to the street.

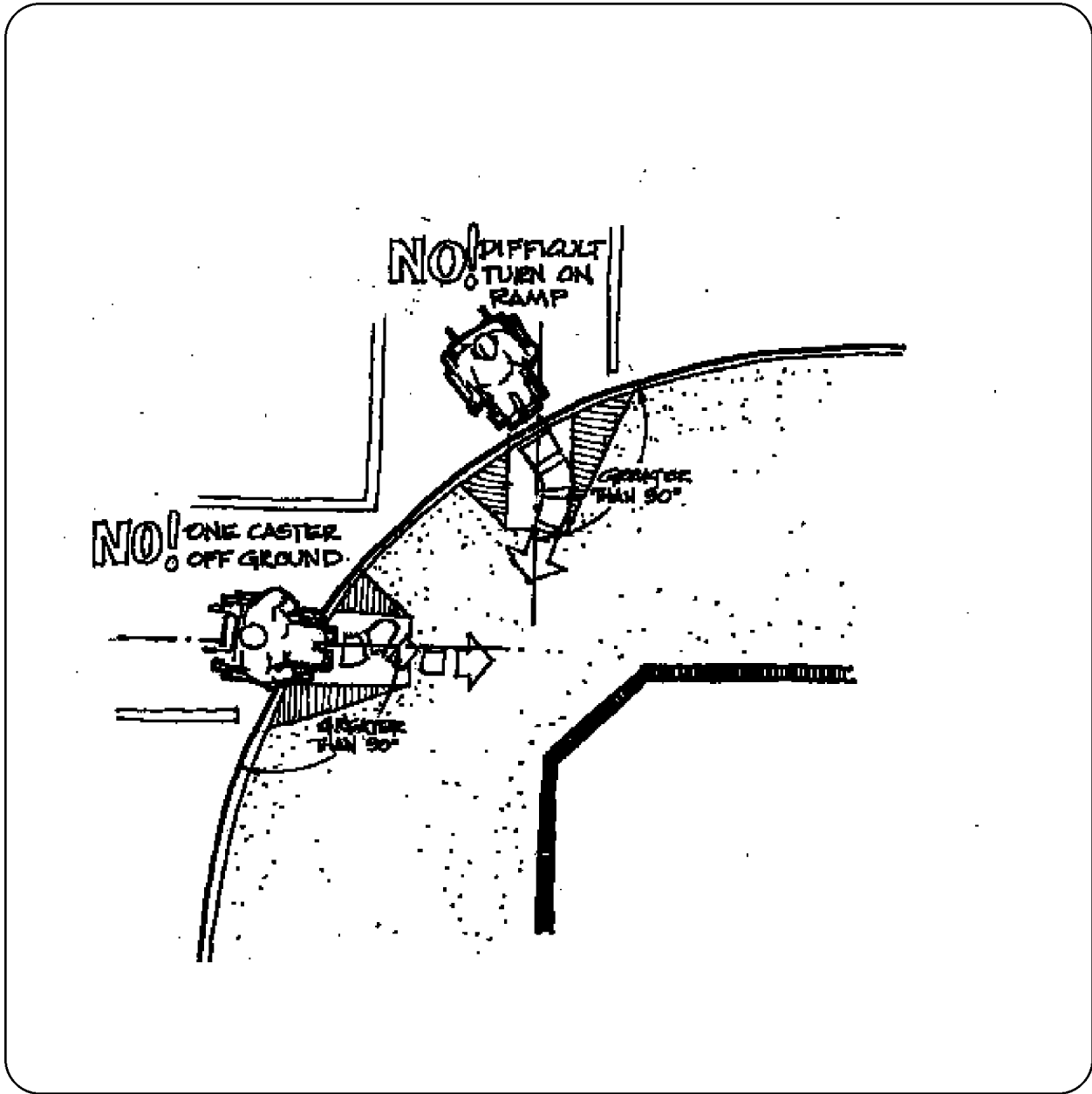

20

Curb ramp configuration

It is not necessary for curb ramps to be in-line with the crosswalk. Avoid curb ramp designs that require an angled approach or a turn during use. Pedestrians who use wheelchairs must 'square off' so that they approach a change in slope with both front wheels at the same time. A skewed approach would leave one caster off the ground, compromising balance and control. Additionally, pedestrians who take a run at an up-ramp cannot easily change direction while ascending. A ramp with one long and one short side is not designed for maximum usability.

The selection of curb ramp type is generally a function of available sidewalk width (SEE FIGURE 21). In new construction, a 6-inch (150-mm) curb height, when combined with the 1:48 (2%) cross slope of the sidewalk, will require a sidewalk width of almost 12 feet (3600 mm) to incorporate a perpendicular ramp at a slope of 1:12 (8.33%) and a top landing that is 48 inches (1220 mm) long.

Designers can often manipulate curb height for a short distance at corners to minimize the sidewalk width necessary to accommodate the desired type of ramp (SEE FIGURE 22). It is also possible to combine types by absorbing part of the elevation change within the run of the sidewalk, thus allowing the perpendicular curb ramp to the street to be a shorter run, as in a combined curb ramp, which may be advantageous in replacing existing ramps that lack landings (SEE FIGURE 23).

Other variables include the slope of curb ramp side flares, the width of a top landing, and the rise of the ramp itself, which may be significantly lessened by extending the ramp through the width of the gutter or altering the design curb height at the intersection.

3.4.3 Curb Ramp Location

As the curb radius increases and the area of the pedestrian corner decreases, there is less sidewalk space available for the installation of curb ramps. In many existing locations, only a single diagonal curb ramp can be contained within the width of the pedestrian crosswalks at the curb. Where existing sidewalks are being retrofitted with curb ramps, it may be impossible to install paired ramps because of the location of existing drainage and sidewalk appurtenances.

Good intersection design practice suggests that all pedestrians enter a crosswalk at the same point (SEE FIGURE 24). Diagonal curb ramps that require pedestrians who use wheelchairs to follow a different route than other pedestrians, where they may not be expected by or may be less visible to a driver, increase the potential for pedestrian-vehicular conflict (SEE FIGURE 25). This is a particular problem with turning vehicles, since a driver may not check for pedestrians entering the crosswalk from non-standard locations.

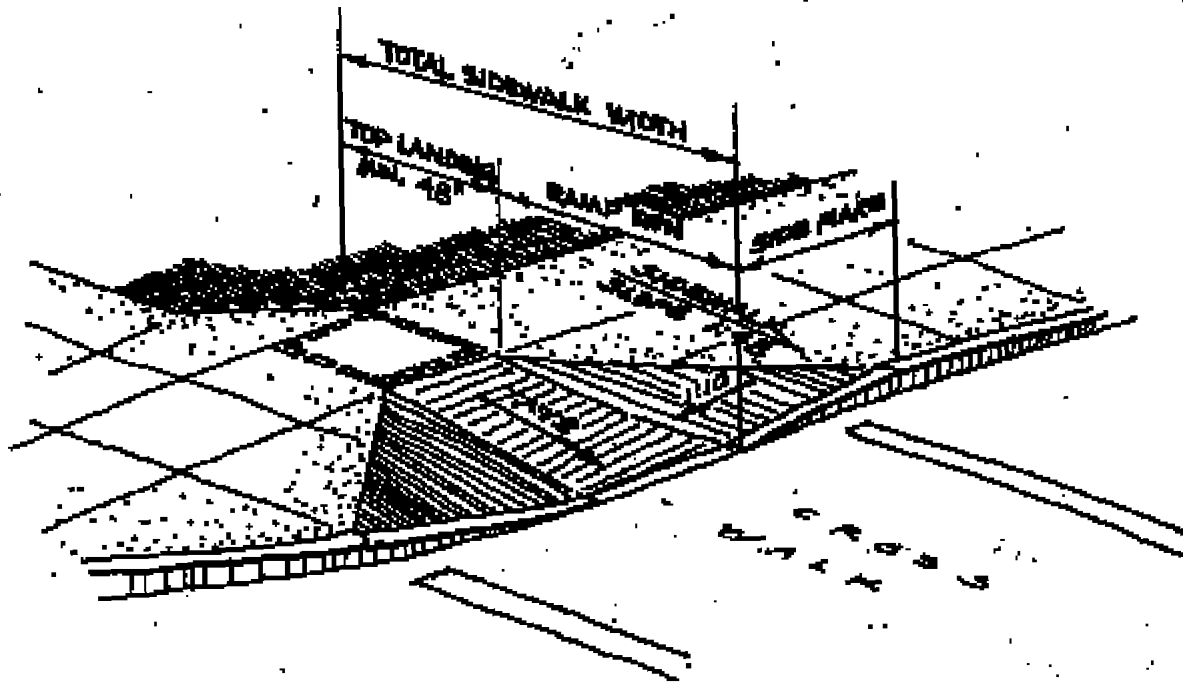

HEIGHT OF CURB FACE	SIDE FLARE WIDTH @ CURB	RAMP RUN LENGTH (PLAN)	TOTAL SIDEWALK WIDTH / 4 LANDING
4 in. (10.2 cm)	40 in. (1.0 m)	65 in. (1.6 m)	111 in. (2.8 m)
5 in. (12.7 cm)	50 in. (1.3 m)	75 in. (2.0 m)	126 in. (3.2 m)
6 in. (15.2 cm)	60 in. (1.5 m)	95 in. (2.4 m)	149 in. (3.6 m)
7 in. (17.8 cm)	70 in. (1.8 m)	111 in. (2.8 m)	159 in. (4.0 m)
7½ in. (19.0 cm)	75 in. (1.9 m)	118½ in. (3.0 m)	166½ in. (4.2 m)
8 in. (20.3)	80 in. (2.0 m)	126 in. (3.2 m)	174 in. (4.4 m)

21

Curb ramp run as a function of curb height

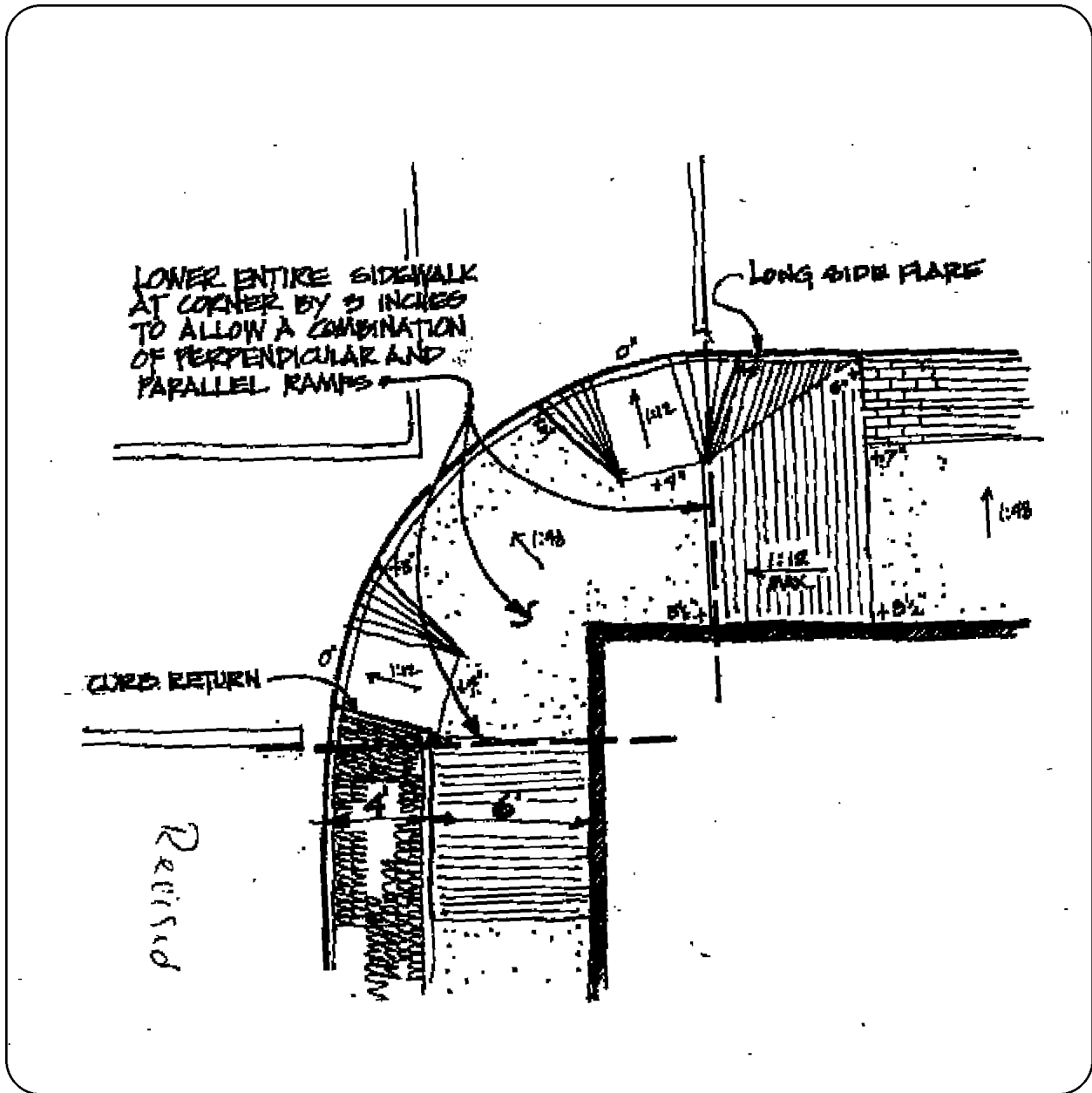

22

Retrofit curb ramp (combined type)

Curb height at intersections can be manipulated to permit shorter ramp runs.

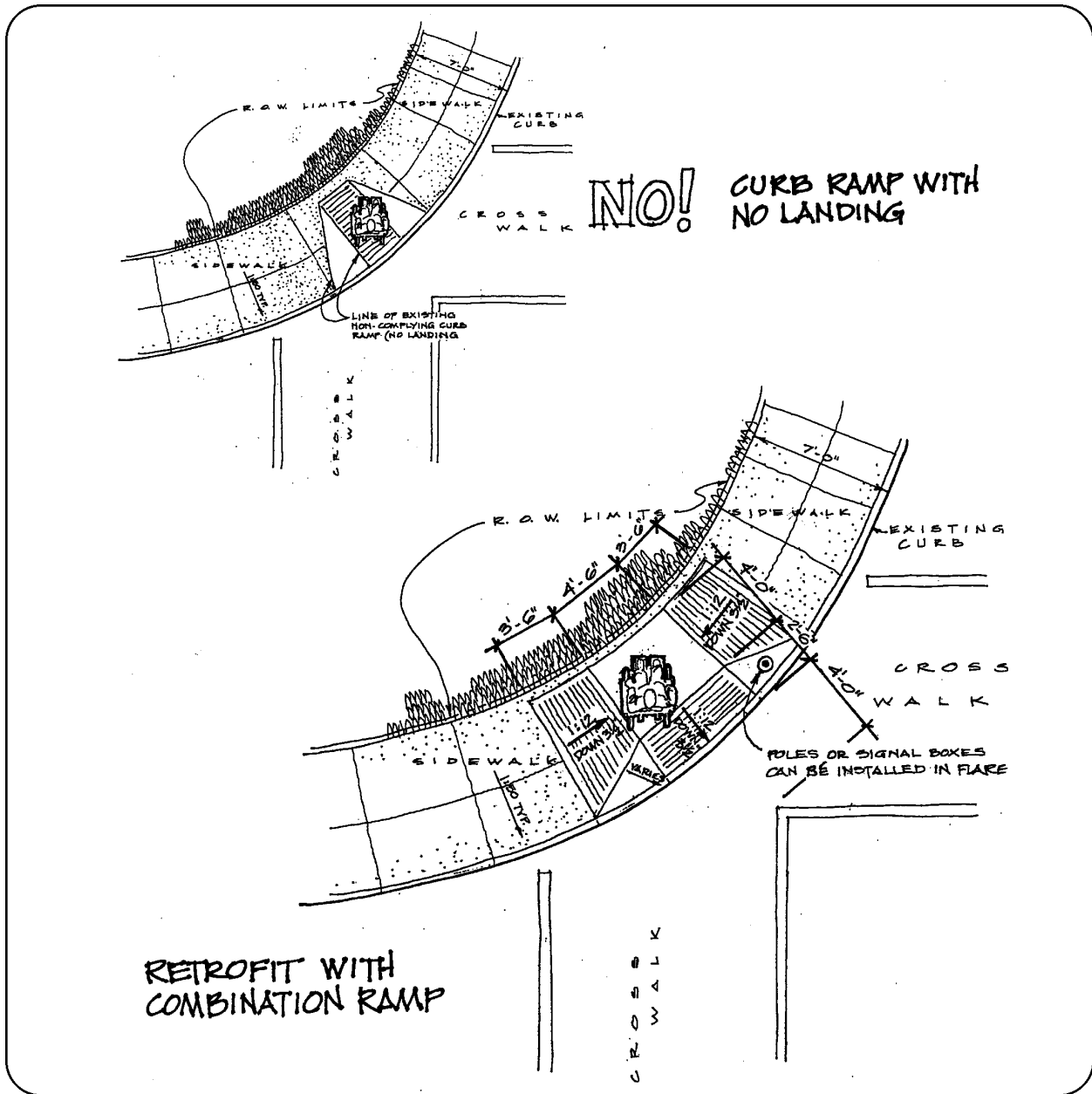

23

Retrofit curb ramp (combined type) for narrow sidewalks

Diagonal (perpendicular) curb ramps installed without required landings can be replaced by a combination of a parallel and perpendicular ramp. In narrower walkways, a 1:10 (10% slope) is permitted in alterations where a 1:12 (8.33%) slope cannot be met.

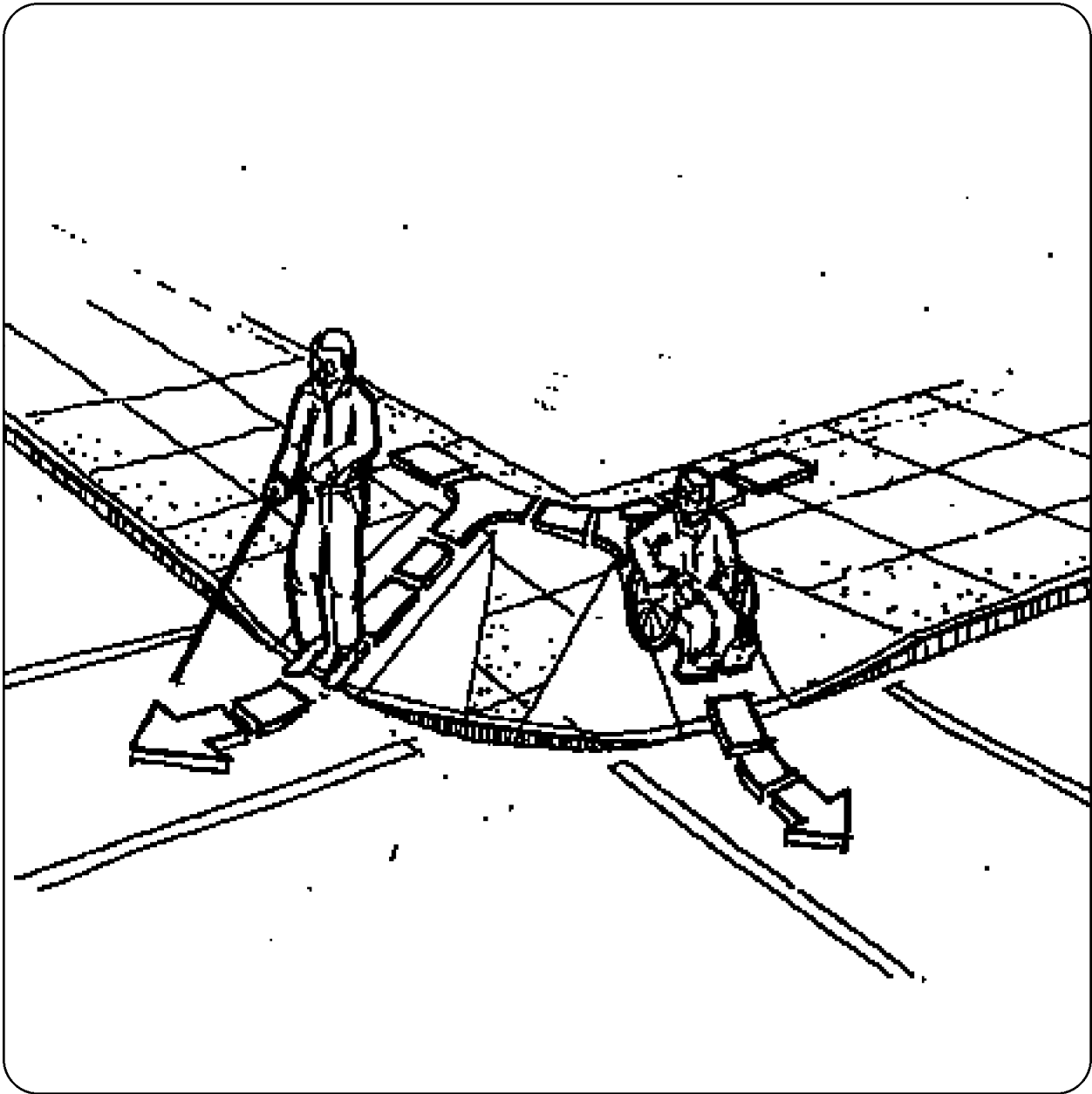
**24****Paired curb ramps**

Paired curb ramps are preferred by users because they permit all pedestrians to enter the crossing at the same point and they provide more useful information to blind pedestrians about the location of the corner and the crossings.

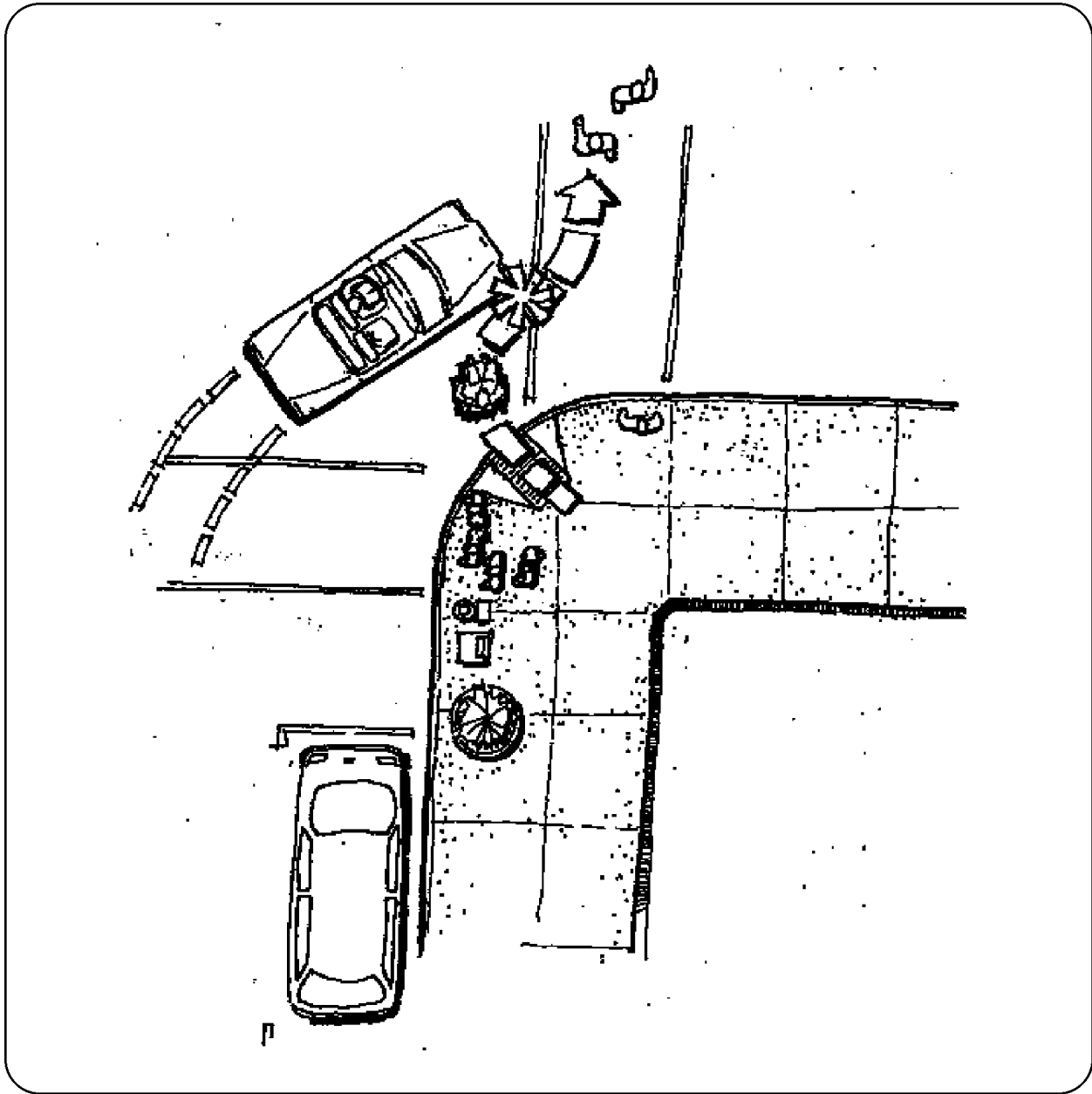

25

Diagonal curb ramps

Diagonal curb ramps are sometimes necessary in alterations where existing site development will not accommodate two ramps or large curb radii leave little sidewalk area at crosswalks. Pedestrians who use wheelchairs must leave the crosswalk to use a diagonal curb ramp. Drivers may not anticipate such a maneuver.

An apex curb ramp must accommodate wheelchair travel to either of the two perpendicular crossing directions. Those on corners with small radii—less than 20 feet (6 m)—expose wheelchair users to moving traffic at the foot of the ramp (SEE FIGURE 26).

Although current standards for diagonal curb ramps on sites require a 24-inch (610 mm) segment of straight curbing adjacent to the flares and within the marked crossing, this is rarely observed in the public right-of-way. This condition cannot be achieved with large curb radii without depressing the entire sidewalk corner, a construction that is problematic for pedestrians who have vision impairments. This requirement was instituted after comments by blind pedestrians that single (diagonal) curb ramps constructed at the apex of a curb return made it difficult to extract directional cues to a crossing. Research on how blind pedestrians make street crossings appears to support this concern. However, orientation and mobility specialists—professionals who teach travel skills to newly blind people and to children who are blind—note that curb ramps are no longer taught as indicators of crossing alignment, although they are one of a group of cues that may be useful in wayfinding by pedestrians who are blind. A diagonal curb ramp does not offer a pedestrian with a vision impairment as much information about an intersection as paired ramps at corners do, particularly with respect to the location of the crosswalk.

For these reasons, diagonal curb ramps are discouraged in new construction. In alterations, they should be considered a less desirable alternative if paired curb ramps can be installed.

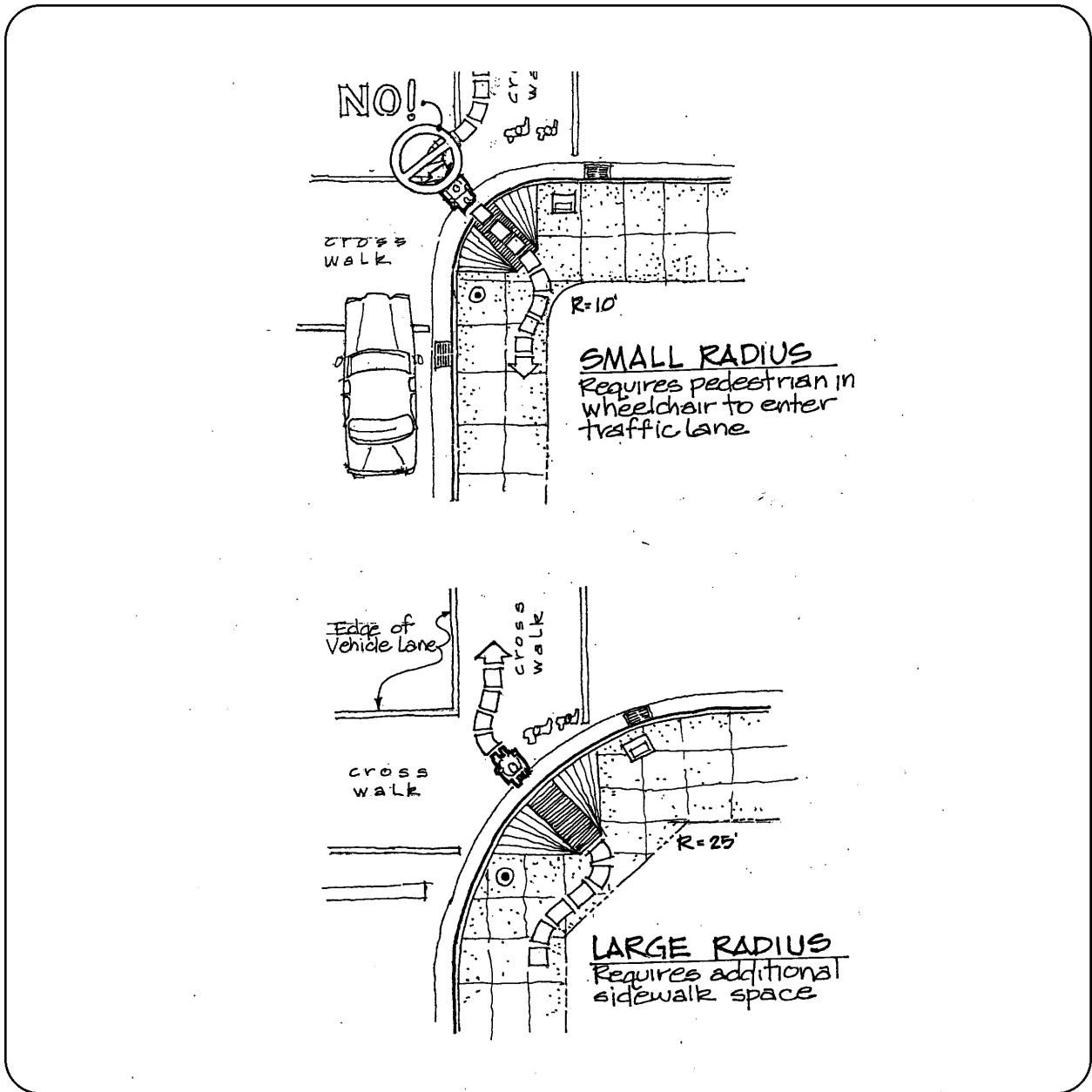

26

Diagonal curb ramps

Where curb radii are less than 20 feet (6 m), a diagonal ramp should be avoided, since moving traffic can encroach on the landing area.

ADAAG 4.7.2 Slope.

Slopes of curb ramps shall comply with 4.8.2. [...] Transitions from ramps to walks, gutters, or streets shall be flush and free of abrupt changes. Maximum slopes of adjoining gutters, road surface immediately adjacent to the curb ramp, or accessible route shall not exceed 1:20.

ADAAG 4.8.2 Slope and Rise.

The least possible slope shall be used for any ramp. The maximum slope of a ramp in new construction shall be 1:12. [...] Curb ramps and ramps to be constructed on existing sites [...] may have slopes and rises as allowed in 4.1.6(3)(a) if space limitations prohibit the use of a 1:12 slope or less.

3.4.4 Running Slope

Curb ramp design requires a balance of run length and slope. Accessibility standards set the maximum slope of a new curb ramp at 1:12 (8.33%) to provide maximum usability for the widest range of people who have mobility impairments. Some pedestrians who use wheelchairs can travel up short runs of steeper slope if the tipping angle of the chair is not exceeded (SEE FIGURE 27). Others will choose to travel with assistance on extreme slopes.

In existing developed rights-of-way, it may be necessary to install a steeper ramp to provide access to street crossings. In an alteration, slopes as steep as 1:10 (10%) are permitted for the distance of a 6-inch (150-mm) rise if it is not technically feasible to provide a ramp at 1:12 (8.33%). For a 3-inch (75-mm) rise, the maximum slope may be as steep as 1:8 (12.5%) where necessary. (In historic facilities, a 1:6 (16.67%) ramp with a maximum run of 24 inches (610 mm) is permitted if a lesser slope is infeasible and if the historic significance of the facility would be threatened or destroyed through the use of complying ramps).

In developed areas with existing sidewalks at steep running slopes, a switchback curb ramp serving the perpendicular crossing may provide a more usable connection to the street.

3.4.5 Cross Slope

Excessive cross slopes on curb ramps can make them unusable by most pedestrians with mobility impairments. The front casters of a wheelchair impart a downhill turning tendency when a cross slope is encountered. Counteracting this unwanted cross force requires manual or battery energy that is then not available for forward travel. Under slippery surface conditions, a loss of control or overturning can result. Such incidents usually end in the street. If a cross slope is extreme, scooters and power chairs with high centers of gravity risk tipping; sideways tips and falls are more common in power chairs and scooters, which are more frequently the aid of choice for outdoor travel. Ambulatory pedestrians who have gait impairments and those who use walking aids will have difficulty maintaining balance and continuing forward travel on curb ramps with excessive cross slope.

Curb ramp cross slope in new construction should not exceed 1:48 (2%). Where street crossings are planned at midblock or at T-intersections on sloping roadways, careful engineering is required to blend curb ramp, landing, and crosswalk at the vehicular way. In alterations, it may be necessary to accept a steeper cross slope because of the difficulty and cost of correction.

3.4.6 Transitions

At the foot of a curb ramp, a flush connection to a moderate gutter counterslope—no more than 1:20 (5%) for a wheelbase distance (approximately 24 inches/610 mm) from the curb—is necessary. This ensures that a wheelchair will not suddenly stop when the front wheels or footrest are caught by an opposing upslope, propelling the pedestrian forward and, perhaps, out of the seat, often with considerable force. In fact, some wheelchair users add seatbelts as insurance against just such conditions. Where there is a rapid transition from downhill to uphill slope over a short distance, a wheelchair may also get “hung up” between the front casters and rear anti-tip bars, leaving the drive wheels spinning uselessly off the ground (SEE FIGURE 27).

It is particularly important that the transition from the ramp to the street be flush, without a lip or other difference in level. Most wheelchairs are propelled by rear drive wheels; the smaller front wheels swivel freely. When these casters hit a raised lip, they swivel sideways and stop (SEE FIGURE 28).

**27****Transitions**

Too steep a ramp slope can cause tipping; once the rear anti-tip bars are engaged, it may be difficult to maintain forward motion and control.

A French firm has developed honeycombed thermoplastic blocks that retain storm water under curbside surfacing materials, discharging stored water gradually into the storm system. Test installations have proven effective in preventing drainage ponding and backup.

ADAAG 4.7.5 Sides of Curb Ramps.

If a curb ramp is located where pedestrians must walk across the ramp, or where it is not protected by handrails or guardrails, it shall have flared sides; the maximum slope of the flare shall be 1:10 [...].

Experts can “pop a wheelie” in a manual chair to overcome such barriers, but many other wheelchair users will not attempt such a risky maneuver. Power chair users may have to retreat--possibly into the street--and try the slope again at greater speed.

Some pedestrians who use wheelchairs will take a run at the upslope of a curb ramp to take advantage of forward momentum. Even a small lip at the gutter edge will interrupt this progress. A substantial lip will cause many wheelchairs to stop abruptly enough to dislodge the user. On a downslope, a lip can cause the front wheels to drop suddenly, pitching the pedestrian forward and into the street (SEE FIGURES 29 AND 30).

In new construction, it is possible to design gutter flow and collection so that water does not pond at the foot of a curb ramp; in alterations, it may be possible to relocate ponding away from the ramp to a less critical location by projecting the toe of the curb ramp through the gutter.

The effect of standard surface drainage design on curb ramp usability has not yet been resolved in street engineering practices. Many features developed to manage water flow--gutter slope, lips, gratings--are inimical to accessibility. Water rises in the toe of a curb ramp (or driveway apron) and may even freeze; even a small lip may make a ramp difficult or unsafe to use; gratings can trap wheels or walking aids. Curbside hydraulic design needs to be re-engineered to address these issues effectively.

Because the side flares of a standard perpendicular curb ramp will exceed the permitted 1:48 (2%) cross slope, an accessible route cannot include travel across a flare. Flared sides are limited in their slope so that they are not a tripping hazard for pedestrians who walk across them. They are not intended for use by pedestrians in wheelchairs, who make a turn into or out of a curb ramp on the landing required at the top. Flares are not required where the edges of a curb ramp are protected by landscaping or by such appurtenances as signal standards, controller boxes, or other barriers to travel across--rather than up or down--a curb ramp (SEE FIGURE 31).



28

Transitions

Vertical changes that exceed 1/4 inch (6 mm) in elevation at adjoining surfaces can cause front casters to swivel and “refuse” at a curb ramp or entrance threshold.



29

Transitions

Like vehicles, wheelchairs risk “bottoming out” or “getting hung up” where opposing slopes are not connected by a level area.



30

Transitions

A sudden drop while descending can propel a pedestrian from his wheelchair.

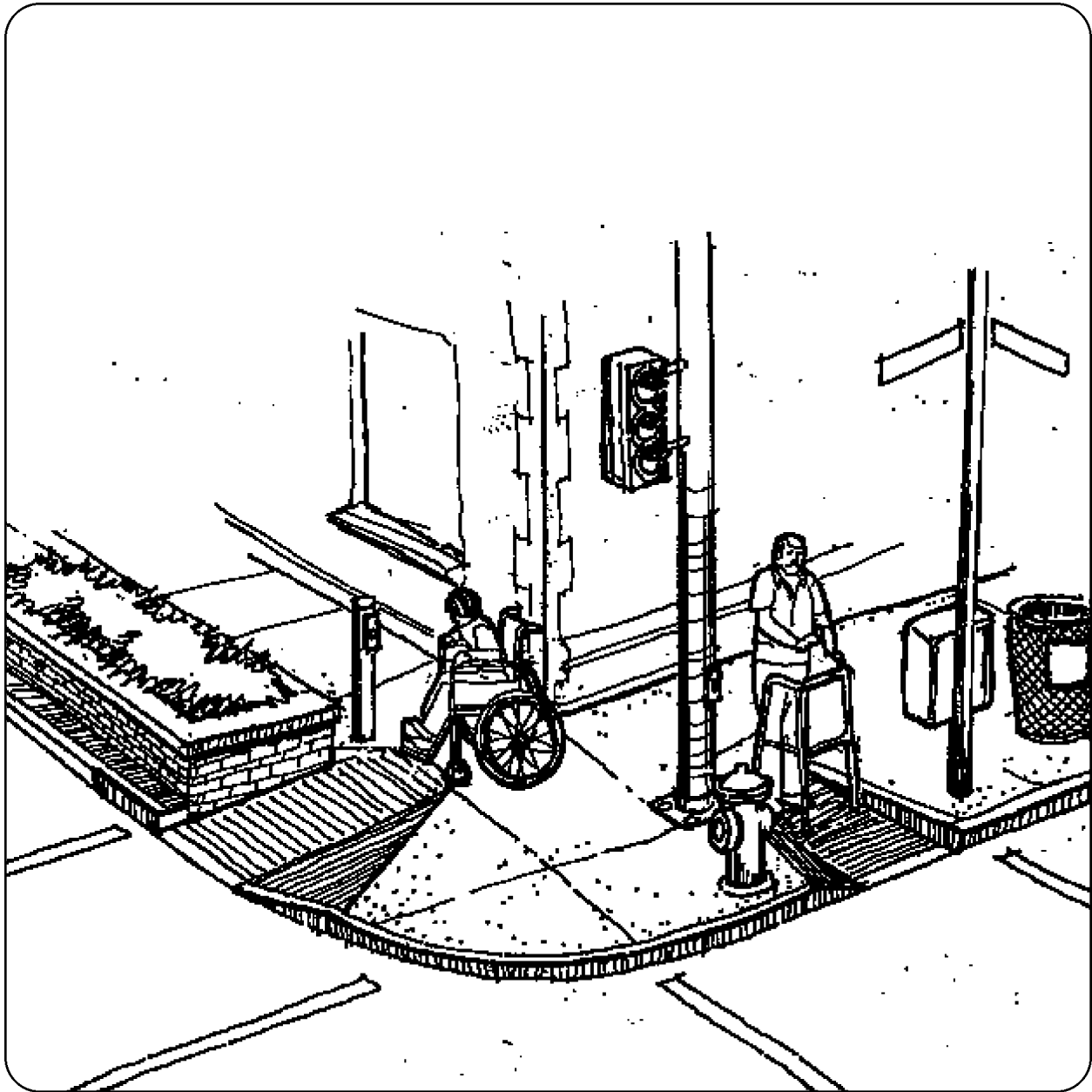

31

Edges of curb ramps

Side flares are not necessary where the ramp is protected from pedestrian cross-travel by planted areas, sidewalk equipment or site furniture, or by handrails or other barriers.

ADAAG Appendix: A4.8.4 Landings.

Level landings are essential toward maintaining an aggregate slope that complies with these guidelines. A ramp landing that is not level causes individuals using wheelchairs to tip backward or bottom out when the ramp is approached.

3.4.7 Landings

Level landings at the tops of curb ramps make it possible to change direction after completing the ascent, rather than during the rise, and to avoid traveling across the compound slope of a side flare when using the sidewalk rather than the curb ramp (SEE FIGURE 32). Top landings also provide a level area that allows pedestrians to bypass curb ramps entirely when traveling around a corner or to a street crossing that is in line with the direction of travel.

A landing length of at least 48 inches (1220 mm), the length of an occupied wheelchair; is required at perpendicular curb ramps in new construction; 60 inches (1525 mm) is preferred. In alterations in more constrained rights-of-way, 36 inches (915 mm) may be adequate if toe room is available beyond the sidewalk. Landing length is measured in the direction of travel to and from the ramp.

On parallel ramps, landings must be at least 60 inches (1525 mm) long to avoid trapping the footrest of a wheelchair between opposing upslopes. Landings are considered "level" when their slopes in the two perpendicular directions of travel do not exceed 1:48 (2%).

Where no turn is required on a landing to enter or leave a curb ramp, the slope of the landing in the direction of travel may be 1:20 (5%). These conditions are commonly found in the crosswalk at the foot of a curb ramp. Where a diagonal curb ramp is installed so that pedestrians using wheelchairs must make a turn to enter the crosswalk, the bottom landing in the street should be level (that is, with no more than a 1:48 [2%] running and cross slope) for a distance of at least 48 inches (1220 mm) to provide maneuvering space. This area should fall within the confines of the crosswalk markings and should not expose pedestrians entering one crossing to vehicles travelling in the opposing direction.

3.4.8 Alternatives to Curb Ramps

Curb ramps are not the only way to make a street crossing accessible to pedestrians who use wheelchairs. Some pedestrian districts have installed raised crosswalks at intersections, requiring vehicles, rather than pedestrians, to ramp up and down (SEE FIGURE 33). Raised crossings (also known as speed tables) are now being designed as traffic-calming measures in

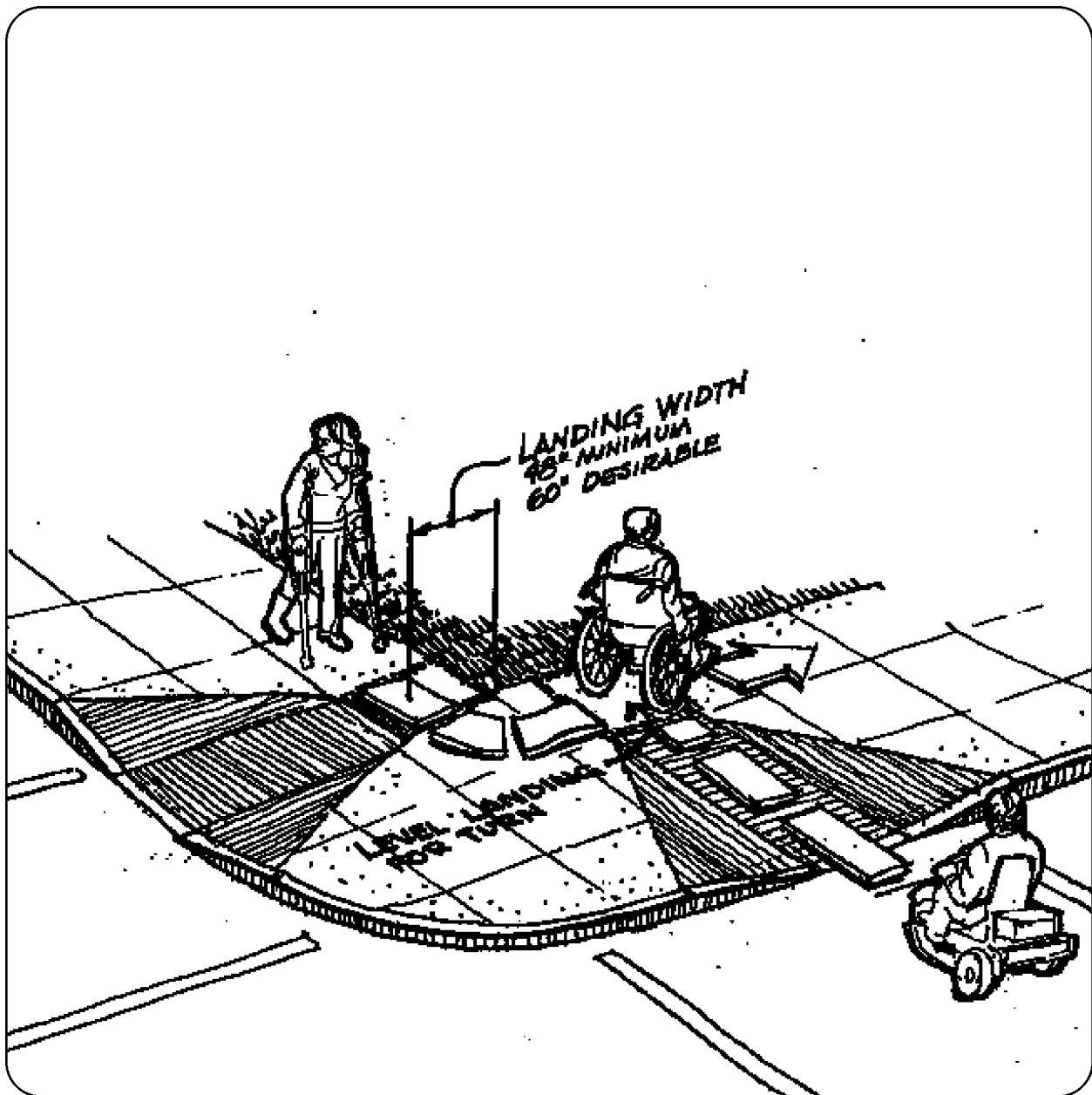

32

Ramp landings

Landings function as turning space when entering or leaving a ramp and also provide space to go by rather than over the curb ramp if continuing around a corner. Landings should not slope more than 1:48 in either direction of travel (i.e., they should be 'level'). A landing is necessary wherever a turn must be made to use a curb ramp.



33

Raised crossing: Cumberland, MD

Raised crossings, in which the sidewalks are continued across an intersection at curb height, requiring vehicles to ramp up and down, can provide the benefits of a ramp-free connection to the street. These can be especially useful in narrow sidewalks. However, a means of discriminating between the sidewalk and the street—typically, a tactile surface treatment—should be provided for pedestrians with vision impairments so that they are aware of leaving the protection of the sidewalk.

many communities and can be useful in making narrow sidewalks accessible without the installation of curb ramps. Care must be taken to ease the vehicle ramp so that drivers with disabilities are not affected by a sudden jolt.

Uncurbed transitions between sidewalk and street make it difficult for pedestrians with vision impairments to identify the boundary between pedestrian and vehicular areas. Detectable warning surfaces (see ADAAG 4.29.2) placed at the edge of the walkway adjacent to the street can provide information about the presence of a crosswalk, replacing the cues once provided by raised curbs. Audible locator tones installed in pedestrian pushbuttons may also be useful in identifying intersections.

Many older cities and towns have sidewalks raised well above street level, with two or three steps at corners to connect to the street crossing. If there is sufficient walkway width to do so, it is possible to ramp a portion of the sidewalk down to the intersection using design criteria for ramps. Although handrails would not usually be provided at curb ramps, they should be installed on longer ramp runs where the elevation change exceeds typical curb height (SEE FIGURE 34).

3.5 Pedestrian Street Crossings

Pedestrians who have vision and mobility impairments and cognitive disabilities are increasingly at a disadvantage when they leave the sidewalk to cross the street. The lack of useful information at intersections for blind pedestrians and those who have low vision is a particular impediment to independent travel.

Computerization of traffic operations has allowed substantial increases in traffic volume by designing for maximum vehicle time and space utilization, usually at the expense of pedestrians. The simple, straightforward street/sidewalk grid, with its 90-degree intersections controlled by fixed-time signaling, has been replaced by free lanes for turning traffic, multiphased crossings, and right turns on red for vehicles. In some configurations, traffic never stops. As complex traffic operations become the norm, pedestrians have had to rely on speed and vision to negotiate intersections.

A recent project in historic Silver City, NM, where sidewalks were almost 30 inches above the street in some locations, demonstrates this approach. Corner radiuses are constructed with stairs, some having as many as 6 risers. Sidewalk ramps, fitted with handrails, begin almost at mid-block and lead to level landings protected by the projection of the stairs at street level.

**34****Elevated sidewalks: Silver City, NM**

Historic sidewalks elevated two to three feet above street grade protected pedestrians from flooding during the region's brief rainy season. Wheeled bridges enabled residents to cross from corner to corner. A decade-long Main Street program added carefully designed long ramps at key intersections.

In Newport, RI, where narrow brick sidewalks in a historic downtown offer few locations for curb ramp installation, planners have proposed to raise the crosswalks to curb height in order to provide barrier-free crossing at major intersections. This solution also has a traffic-calming effect, but has raised concerns among blind residents about the detectability of the street edge.

Cumberland, MD's downtown pedestrian mall employs raised crosswalks at cross streets, slowing the speed of vehicles at these intersections, where cars-not pedestrians-must ramp up to, across, and down. Such 'speed tables' can be effective traffic calming devices, but do not provide notice to blind pedestrians of the boundary between pedestrian and vehicular areas. The Access Board recommends that detectable warnings be installed at such intersections.

California's accessibility regulation, title 24, requires a 24-inch-wide strip of detectable warning material where sidewalks enter a roadway without an intervening curb face. Several other states, including Florida and New Jersey, have adopted codes requiring detectable warnings. Austin, TX requires detectable warnings on all new curb ramps. Australia, Great Britain, and Japan have longstanding requirements for tactile surfaces. The International Standards Organization (ISO) is currently developing a standard for tactile pedestrian indicators. The ADAAG detectable warnings provision has been temporarily suspended for sidewalk applications, but is required at transit platforms.

3.5.1 Street/Sidewalk Detectability

Sidewalks that ramp gradually down to a street crossing give little notice of the change from pedestrian to vehicular way for pedestrians who are blind. The blended or depressed corners and wide diagonal curb ramps popular in downtown improvement projects a decade ago were found to be difficult to detect; pedestrians with vision impairments were not able to identify the boundary between the sidewalk and the street. Raised crosswalks that continue across a street at curb height do not provide curblines cues for pedestrians with vision impairments. Narrower curb ramps with more steeply sloping side flares or returned curbing are, however, easily identified using a long cane. Research supports the need for additional cues for blind pedestrians at locations where standard indicators, such as curbs or detectable curb ramp slopes, are absent.

Where ramp slopes fall below detectable limits (in California, ramp slopes of 1:15/6.67% or less), a tactile feature underfoot—such as the truncated domes of the ADAAG detectable warning specification—can provide a confirming cue (SEE FIGURE 35), if their meaning is known. However, there has been controversy about the application of detectable warnings on exterior sloped areas. A joint rulemaking by the Access Board, DOJ, and DOT has temporarily suspended the ADAAG requirement for detectable warnings on curb ramps, at reflecting pools, and at hazardous vehicular areas until July 2001 to determine if such surfaces pose problems for pedestrians who have mobility impairments (see "Technical Assistance Bulletin #1: Detectable Warnings"). Research completed for the Access Board in 1994 did not reveal any safety problems with detectable warnings installed on pedestrian surfaces. However, pedestrians with mobility impairments have expressed concern over their use on the slopes of curb ramps and transportation agencies anticipate problems with snow removal.

Over 30 U.S. firms currently manufacture the distinctive truncated dome surfacing that signals an approaching curblines underfoot. This tactile treatment is required at transit platform edges in the United States and is widely installed on curb ramps and at intersections in Japan, Australia, and Great Britain. Germany, France, and Belgium have begun pilot tests. An international standard is under development. Several U.S. cities have continued to install detectable warnings on new and altered curb ramps without reported problems. Engineers have suggested that the rows of flat-topped domes

**35****Detectable warnings**

Research has shown that a regular pattern of raised truncated domes is highly detectable underfoot and to a cane. For pedestrians with vision impairments, detectable warnings can provide a confirming cue of the street edge.

Japan, Canada, Great Britain, Australia, and Germany have developed standards for accessible pedestrian signals (APS). The International Standards Organization (ISO) is currently finalizing an APS standard. The California Traffic Manual also contains an APS standard.

Intersections in some parts of San Francisco are being fitted with infrared emitters that can send verbal crossing information on signal phase, street location, crossing direction, and even crossing type to pedestrians carrying individual receivers.

The City of Los Angeles has developed a rating system for street crossings to confirm the need for accessible pedestrian signals (APS). Engineers evaluate proximity to transit, pedestrian accidents, intersection configuration, street width, vehicle speed, traffic volumes and flow, and a range of special conditions that include right-turning volume, complex phasing, right turn signals, free right turns, and other items to arrive at a point total for each intersection that can be used to warrant requested signals. In 1985, the City of San Diego implemented an intersection evaluation policy for APS installation.

Research conducted in New York and in Clearwater, FL indicates that an audible pedhead prompt improves pedestrian safety. Engineers tested voiced reminders to pedestrians to 'look both ways' before entering a crossing.

(less than 1/4 in/6.5 mm high) be oriented to provide a clear track for wheelchair passage over a curb ramp. Some pedestrians who are blind recommend a width of only 24 inches (610 mm)--as is required along transit platforms--for adequate detectability, which may be less objectionable to wheelchair users.

Pedestrians who have low vision will benefit from the marking of curb ramp surfaces with a contrasting color, texture, pattern, or other finish; many would choose to avoid a curb ramp, if possible. Wheelchair users have also reported the effectiveness of a contrast in curb ramp surface in identifying where an opposing curb ramp meets the street, allowing pedestrians to travel quickly and directly across the roadway to an up-ramp. Where concrete paints or stains are used, care must be taken to ensure a slip-resistant surface, particularly when wet.

Transportation industry research on color, contrast, and visibility for roadway markings has not included subjects who have low or otherwise impaired vision. Until testing can be undertaken to determine the effectiveness of standard pedestrian markings for these users, the criteria in the Manual on Uniform Traffic Control Devices (MUTCD) are a useful guide. Several states require a particular color to mark accessible features; however, there are no specific color requirements in ADAAG or UFAS.

3.5.2 Accessible Pedestrian Signals (APS)

Pedestrians who are blind use audible and tactile cues in independent travel. At intersections with fixed-time signal phasing and consistent traffic flow, traffic light changes will be reflected in parallel or perpendicular traffic surges. The sounds of these surges are used by blind pedestrians to identify appropriate crossing intervals.

Intersections that have actuated signal timings, complex traffic patterns, or intermittent or sporadic traffic volumes may pose problems for pedestrians who have vision impairments. At these intersections, the signals for automobile and pedestrian traffic do not automatically correspond. Frequently, a separate WALK signal and phase is provided for pedestrians in response to a pushbutton. At this type of crossing (as well as at several other types, including midblock crossings where there is no parallel flow to rely on), an

accessible pedestrian signal (APS) may be desirable to provide blind and low-vision pedestrians with an equivalent to the visual signal provided for other pedestrians.

Although audible crossing indicators have been available for over 20 years, they have not been well received by traffic planners in the United States. This is probably attributable to two factors: One is noise pollution and consequent community opposition; the other is disagreement among blind people on the need for audible pedestrian signals.

TEA-21 amended Federal transportation law to include a directive that audible pedestrian signals be considered where appropriate for pedestrian safety. However, accessibility standards do not yet include scoping or technical specifications for audible crossing signals or other means of communicating visible information to pedestrians who have vision impairments. A standard has been proposed for inclusion in the next edition (2000) of the Manual of Uniform Traffic Control Devices.

3.5.3 Types of Accessible Pedestrian Signals

The Access Board has published "Accessible Pedestrian Signals" (publication A-37), a synthesis of current signal technology that includes a matrix comparing the features of units manufactured both in the U.S. and abroad. The Institute of Transportation Engineers has established an industry-consumer committee to develop technical assistance on APS installations.

When a resident requests the installation of an audible signal—or signals—along a particular route, local traffic engineers may consider a wider range of options today than the audible indicator that chirps or tweets to indicate the walk phase. Units are available that click or buzz at low frequencies and can indicate start times through vibration for people who are both deaf and blind. These units produce sound with less amplification than earlier units and may, therefore, be more acceptable to neighbors. Also available are pedestrian pushbuttons that produce a low-intensity, low-frequency click, allowing pedestrians with vision impairments to locate the control easily. Making the existence and location of the actuating device known to blind users has been a long-standing problem in pedestrian signal design.

In the last decade, development of broadcast signage and similar technologies has also promised to improve access to crossing information for pedestrians who are blind. Applications of intelligent transportation technologies now being deployed on highways may offer other solutions for pedestrians with disabilities.

In responding to a request for an accessible pedestrian signal, the engineer may find it useful to work closely with the blind pedestrian who will be using the intersection and with an orientation and mobility specialist. Mobility specialists can offer a useful perspective, because they are aware of the problems caused by the various types of intersections and because they understand the skills required by blindness. Any APS chosen must be carefully installed and adjusted so as not to interfere with the ability of the blind pedestrian to hear the sound of traffic, which will always remain of paramount concern.

Some mobility instructors suggest that audible pedestrian signals may also be useful to people who have cognitive impairments and to children and older people who have slower reaction times. In fact, recent research in New York City indicated that pedestrian safety in general can be enhanced through the use of recorded announcements at intersections. Providing audible information about crossing time can also speed pedestrian clearance.

Many traffic departments are considering the installation of automatic pedestrian-sensing equipment to trigger walk cycles. Some systems can extend crossing time, if needed, or cancel the signal altogether if the pedestrian crosses early. Such systems are not useful to pedestrians with vision impairments unless there is an audible indication of the crossing interval and a way of identifying intersections that have this type of actuation.

The city of Corvallis, OR has installed audible pedestrian signals at all of its signalized intersections.

3.5.4 Pedestrian Pushbuttons

Where a pushbutton or other operable device is provided for the use of pedestrians, the mechanism should not require more than 5 pounds (22.2 N) of force to activate. Because outdoor devices will often be used by pedestrians who are wearing gloves or whose movements may be restricted by bulky clothing, it is advisable to select the largest available pushbutton or bar dimension--a 2-inch (50 mm) minimum is recommended--and to ensure that

CONTROLS/OPERATION

- ✓ 5# (22.2N) maximum operating force
- ✓ no tight grasping, pinching, twisting of wrist
- ✓ one-hand operation
- ✓ highest operable part within reach range

ADAAG Appendix:**A4.3.1(1) Travel Distances.**

Many people with mobility impairments can move at only very slow speeds; for many, traveling 200 ft (61 m) could take about 2 minutes. This assumes a rate of about 1.5 ft/s (455 mm/s) on level ground. It also assumes that the traveler would move continuously. However, on trips over 100 ft (30 m), disabled people are apt to rest frequently, which substantially increases their trip times. Resting periods of 2 minutes for every 100 ft (30 m) can be used to estimate travel times for people with severely limited stamina. In inclement weather, slow progress and resting can greatly increase a disabled person's exposure to the elements.

it is raised above the surrounding surface for ease of operation. Devices that can be operated by a closed fist acting on any point on the surface will be most usable by pedestrians who have mobility impairments.

Pedestrian signal controls should be located within reasonable proximity of the curb ramp and crosswalk. The bar or button should be mounted within allowable reach ranges for pedestrians who use wheelchairs. A height of 42 inches (1065 mm)--the height required for elevator buttons--is recommended. There should be a 30" x 48" (760 mm X 1220 mm) level ground surface centered on each control for a forward or side approach, as appropriate. If a forward approach is provided, the button should be located in the same vertical plane as the leading edge of the clear ground space; if a side approach is planned, the clear ground space should be within 10 inches (255 mm) horizontally of the button. Pedestrians who use wheelchairs should be able to operate the button from a level landing rather than the sloped surface of a ramp.

Pedestrians who are blind should not have to travel more than a few steps to operate a button and then return to the curb to orient themselves for the crossing. It should be clear, by button location and associated tactile signage, which crossing direction is controlled; buttons for different crossings should not be mounted on the same face of a pole, and should be on separate standards if possible. A mounting pole may be used to shield the side of a curb ramp in place of a flared side.

3.5.5 Crossing Times

Crossing times that are based only on the 4-feet-per-second (1220-mm/s) walking speed of able-bodied adults will not be sufficient for pedestrians who do not start to cross immediately after the walk interval begins or whose walking speed is affected by a mobility impairment, stamina, or age (SEE FIGURE 36). Pedestrians who are blind or have low vision, those who have cognitive disabilities, and elderly pedestrians typically delay leaving the curb until they can satisfy themselves that vehicles have stopped.

Pedestrians who use wheelchairs typically travel faster than 4 feet per second (1220 mm/s), but those who use other mobility aids or who have gait or stamina impairments may travel at 1.5 feet per second (455 mm/s)

**36****Walking speed**

Many pedestrians travel much more slowly than 4 feet per second. Transportation industry research suggests that a more conservative walking speed—approximately 3.1 feet per second—may be warranted where pedestrian use is high. Where roadways are divided by medians, a safe waiting area should be provided. If pedestrian signals must be actuated, a pushbutton should be provided at the island. It should be located within accessible reach ranges. An audible indicator can identify the button location for pedestrians who are blind.

Flashing crosswalks have been installed in Santa Rosa, CA to alert drivers. Devices developed from aircraft landing lights have been embedded in the roadway surface. Pedestrian actuation triggers their operation. The contrast has been reported to be highly useful to pedestrians with vision impairments.

or less. Although the needs of elderly and disabled pedestrians have been widely studied, many of these research projects seem based on prescribing for the “special” circumstance in which such pedestrians are the only or the primary users of a crossing.

In fact, a truly representative sample of pedestrians would always include a few individuals whose travel speeds fall well below 4 feet per second (1220 mm/s). Options available to the traffic engineer include increasing the crossing time, decreasing the distance (using smaller curb radii or neckdowns and bulbouts that extend intersection corners across the width of the parking lane), subdividing the distance (using medians or refuge islands, with separate pedestrian controls on the median), or providing a pedestrian-actuated control that permits extended-time crossing on demand.

3.5.6 Marked Crossings

In a Canadian study now more than 15 years old, elderly and disabled pedestrians identified marked crossings as the single most valued intersection improvement. Like audible crossing signals, however, the subject of marked crosswalks has generated much industry discussion. Some believe that marked crossings threaten pedestrian safety by leading pedestrians to act on the belief that marked crosswalks offer them some protection. Others maintain that marked crosswalks do protect pedestrians and enhance their safety. Research currently underway for the FHWA may settle this debate. Accessibility provisions requiring the foot of a curb ramp to be contained within a crosswalk, where one exists, suggest that marked crossings are viewed as safety features.

MUTCD marking standards require white lines; where pavement is light colored, black edging is recommended to improve contrast. No test or value for contrast is provided. A 1988 FHWA study found that high-visibility/ladder-type crosswalk markings using a 12-inch (305-mm) stripe with 24-inch (610-mm) spacing had the highest level of motorist recognition. Because juvenile, elderly, and disabled pedestrians are highly dependent on transit, such markings are recommended at crossings that serve bus and other transit stops and stations.

3.5.7 Islands

Raised traffic islands should be cut through level with the street (a slight crowning of no more than 1:20 [5%] is permissible if necessary for positive drainage) if it is not possible to provide complying ramps at each curb and a 48-inch-long (1220-mm) level landing between them (SEE FIGURE 37). Designers should avoid offsetting ramps unless crosswalk locations determine such placement, in which case landings and a complying route between them must be provided (SEE FIGURE 38). Because the length of an occupied wheelchair is 48 inches (1220 mm), a cut-through median should provide some additional maneuvering length for safe refuge from traffic. A 60-inch (1525 mm) pedestrian space will accommodate longer wheelchairs and scooters more comfortably.

Raised islands that are cut through may limit wheelchair travel to a single user per crossing cycle. However, wider openings may not give blind pedestrians adequate cues about the presence of a median or the nature of a crossing. In such cases, detectable warnings underfoot can help identify the pedestrian area.

Where two signal cycles are required to complete a crossing, pedestrians with vision impairments should be advised with audible or other signals of the need to wait for the next crossing interval. A locator tone in the pushbutton on the median can provide this information. Devices that tick down the remaining crossing time may be helpful, if both visible and audible output is provided.

3.5.8 Overpasses and Underpasses

Grade-separated walkways, whether air-rights construction over the right-of-way or underground passageways beneath it, should be accessible by ramp or elevator (SEE FIGURES 39 AND 40). Circular or helical ramps do not meet most accessibility requirements, because they cannot accommodate the level landings required for every 30 inches of rise. Furthermore, such ramps produce a differential in slope for inside and outside wheelbases unless very large radii are used.

In suburban and rural areas where the extended right-of-way necessary to

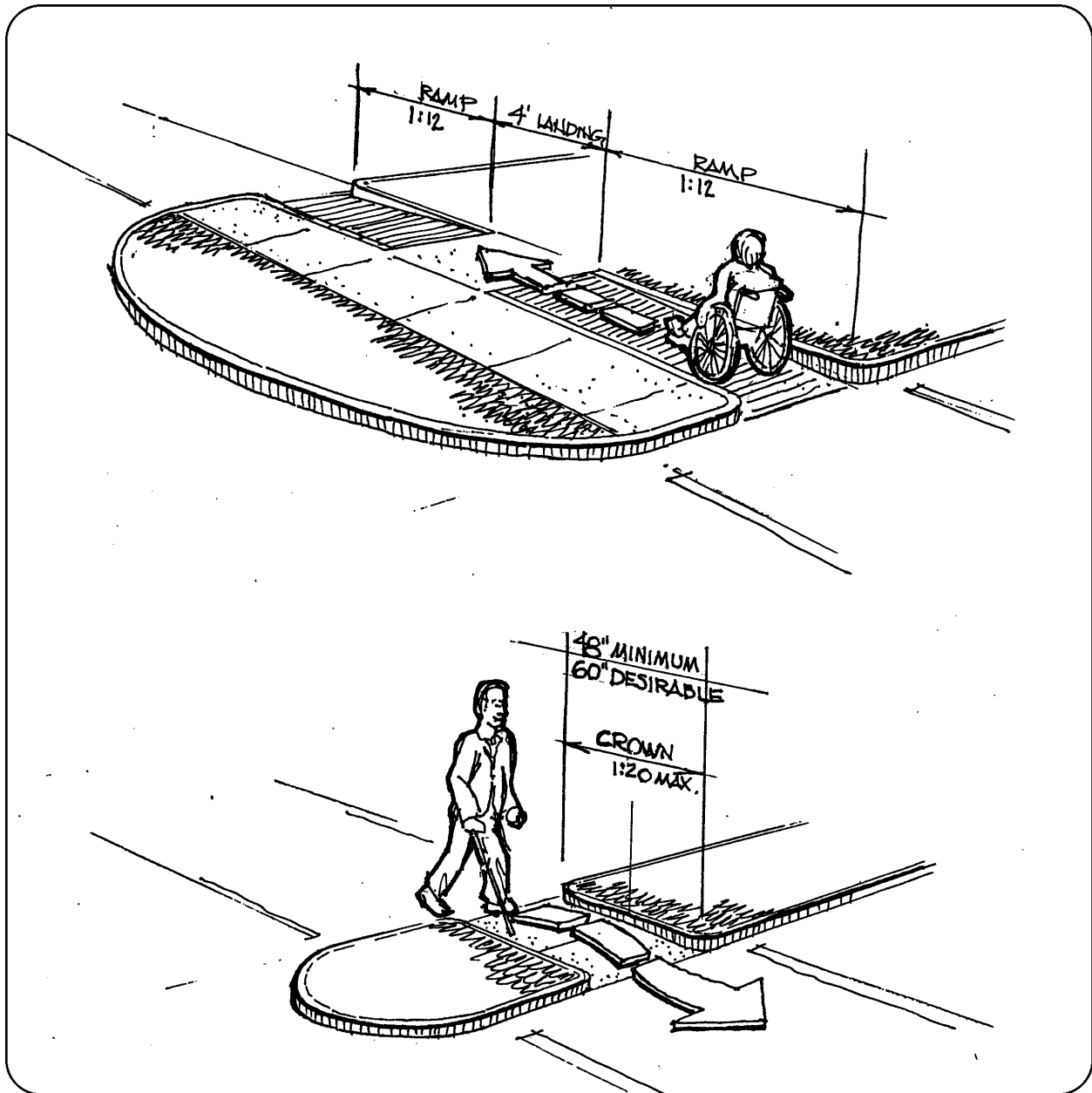

37

Islands and medians

Where medians or islands are provided for pedestrian refuge, they should be designed to provide accessible passage over or through them. Where pedestrian actuation of signals, including signals usable by blind and low-vision pedestrians, is necessary at the median, the button should be located at an accessible height and within reach of the passage at a level landing or at the midpoint of a cut-through.



38

Curb ramps at splitter island: Washington, DC

At first glance, these curb ramps may seem accessible. However, closer inspection reveals that there is no route between the two that is usable by a pedestrian in a wheelchair. Additionally, the granite pavers should not be considered an accessible surface.



39

Pedestrian overpass: La Jolla, CA

This overcrossing connects campus circulation routes with elevator access to waterfront classrooms below.

**40****Elevator access to steeply sloping site: La Jolla, CA**

Even with landings at every 30 inches of rise, continuous ramps are not the most usable choice for differences in elevation of a story or more. Elevator access to subway and elevated rail lines is now commonly provided by elevator and should be considered for highway, railroad, and other crossings and for steeply sloping terrain.

A New Jersey Transit Authority policy requires elevators where grade changes at overpasses and underpasses exceed 60 inches (1525 mm). New pedestrian bridges in Las Vegas, New York City, and San Juan, PR incorporate elevator access at each end.

A decade ago, Seattle pioneered a network of accessible through-block pedestrian routes that make use of elevators in existing buildings to travel from one street elevation to another.

In La Jolla, CA, a pedestrian route on the campus of the Scripps Oceanographic Institute begins at grade, extends in a bridge over a roadway, and connects to two four-stop hydraulic elevators that step down the coastal cliff to a research station on the waterfront.

ADAAG 4.2.4 Clear Floor or Ground Space for Wheelchairs.

The minimum clear floor or ground space required to accommodate a single stationary wheelchair and occupant is 30 in by 48 in (760 mm by 1220 mm). The minimum clear floor or ground space for wheelchairs may be positioned for forward or parallel approach to an object. Clear floor or ground space may be part of the knee space required under some objects.

STREET FURNITURE

- ✓ **30" x 48" (915 x 1220 mm) clear ground area at the element**
- ✓ **unobstructed reach range to highest operable part:**
 - forward (48" [1220mm] high maximum/15" [380 mm] minimum)
 - or
 - side (54" [1370 mm] high maximum/9" [230 mm] minimum)
- ✓ **operating force no greater than 5# (22.2N)**
- ✓ **hardware operable with one hand without tight grasping, pinching, or twisting of the wrist**
- ✓ **knee room 27" (685 mm) high, 30" (760 mm) wide, 19" (485 mm) deep where necessary for use**

ramp a 14-foot-high overpass is not a problem, ramp/landing runs over 300 feet long are not uncommon. Although such ramps meet accessibility criteria, many pedestrians with disabilities would not consider them usable at such lengths. Research with a small group of manual wheelchair users revealed that a majority could not complete a continuous ramp comprising three 1:12 (8.33%) slopes, each rising 30 inches (760 mm) to a level landing between segments) in one sustained effort. Other research suggests that many manual wheelchair users and people who use walking aids have difficulty completing even a single run of this length and slope. Where it is necessary to provide lengthy ramps, it is useful to design more frequent landings and lesser slopes for each successive segment.

In urban areas, elevators are increasingly being installed to serve elevated crossings and upper level walkways in much the same way that two- or three-stop hydraulic elevators have become the common route for below-grade transit access. Elevators are also being used to provide an accessible route on hilly sites (SEE FIGURES 41 AND 42).

Accessibility standards for transportation facilities require a ramped over- or underpass where the accessible route in a transit station crosses a rail line that has a flangeway gap that exceeds 2-1/2 inches (63 mm). FHWA standards promulgated as part of the DOT regulations implementing the Rehabilitation Act of 1973 have long required overpasses and underpasses on Federal-aid highways to be accessible to pedestrians who cannot use stairs.

3.6 Street Furniture and Equipment

Items installed for pedestrian use on or along a sidewalk should be accessible. Because most are single installations at intervals along a sidewalk, each individual location should provide accessible items. General accessibility provisions for street furniture and related streetside amenities include the following commonly provided elements.

3.6.1 Benches

Specifications for benches that are included in standards for dressing-room facilities and those for fixed seating at counters are not directly applicable to the design of streetscape benches. Pedestrians with disabilities will appreciate walkway seating with a fairly high seat, a shallow front-to-back dimen-



41

Public sidewalk elevator: Lynchburg, VA

Sidewalk elevations that differ by the equivalent of five stories are connected with this sidewalk elevator between buildings in the upper town and its riverfront.



42

Public sidewalk elevator: Lynchburg, VA

BENCHES

- ✓ 19" (485 mm) seat height
- ✓ shallow front-to-back dimension (24" [610 mm] recommended)
- ✓ supportive back
- ✓ armrests (for ease in sitting/standing)
- ✓ level base

TELEPHONES

- ✓ highest operable part within reach range
- ✓ volume control/hearing-aid compatible
- ✓ TTY capability

DRINKING FOUNTAINS

- ✓ "hi-lo"
- ✓ avoid projecting into circulation route
- ✓ accessible controls

ADAAG Appendix: A4.15 Drinking Fountains and Water Coolers.

[...] Two drinking fountains, mounted side by side or on a single post, are usable by people with disabilities and people who find it difficult to bend over.

sion, a supportive back, and an armrest for making the transition between standing and sitting (SEE FIGURE 43). Although basic accessibility scoping might suggest that only one bench in a grouping needs to meet these recommendations, design consistency and volume-purchasing discounts encourage standardization.

Disabled and elderly pedestrians have expressed strong support for requiring benches at regular intervals along public streets, especially where sidewalks slope steeply. A level area should be provided for the bench.

3.6.2 Telephones

Public pay telephones are frequently grouped on urban streets. This can permit one instrument to be installed at a wheelchair-accessible height and another to be mounted higher to enable pedestrians who have difficulty bending or stooping to use it easily. Exterior telephones can now incorporate a text telephone (or TTY) for nonvoiced communications, as well, so that a single unit can provide access to most users (SEE FIGURE 44). If only one instrument is provided, it should also be wheelchair accessible. All voice instruments intended for outdoor installations should have volume controls (routinely provided today) and be hearing-aid compatible. Additional information is available from the Access Board publication "Bulletin #3: Text Telephones."

3.6.3 Drinking Fountains

Wheelchair-accessible and standing-height drinking fountains should also be combined when installed on public sidewalks, because there may be considerable distances between these fixtures. Both drinking fountains and telephones need to be carefully located to avoid projecting into a circulation route. Note that the minimum knee room required for a drinking fountain—27 inches (685 mm)—is also the maximum height at which a projection over the sidewalk will be detectable by a pedestrian using a cane.

**43****Sidewalk benches**

Benches will be most useful to pedestrians if there are both arms and backs for support when transitioning from a sitting or standing position.



44

Exterior text telephone

Weather- and vandal-resistant TTYs for outdoor installation are available from several manufacturers.

SIDEWALK TOILETS

- ✓ each toilet room accessible
- ✓ accessible fixtures and fixture spaces
- ✓ grab bars
- ✓ maneuvering space at doors
- ✓ accessible hardware and accessories

ADAAG 4.1.3(11) Toilet Facilities.

If toilet rooms are provided, then each public and common use toilet room shall comply with 4.22. [...]

Several cities (San Francisco, New York City, Seattle, Philadelphia, and others) have tested accessible self-cleaning sidewalk toilets to widespread public enthusiasm and approval. Maintenance operations are typically supported by the sale of kiosk-mounted advertising.

ADAAG 4.30.3 Character Height.

Characters and numbers on signs shall be sized according to the viewing distance from which they are to be read. [...]

ADAAG 4.30.5 Finish and Contrast.

The characters and background of signs shall be eggshell, matte, or other non-glare finish. Characters and symbols shall contrast with their background—either light characters on a dark background or dark characters on a light background.

ADAAG Appendix:**A4.30.2 Character Proportion.**

The legibility of printed characters is a function of the viewing distance, character height, the ratio of stroke width to the height of the character, the contrast of color between character and background, and print font. The size of characters must be based upon the intended viewing distance. A severely nearsighted person may have to be much closer to recognize a character of a given size than a person with normal visual acuity.

3.6.4 Sidewalk Toilets

Several manufacturers are now providing and maintaining fixed, single-user toilet units for street-corner installation (SEE FIGURE 45). Accessibility standards require every newly constructed toilet facility to contain accessible fixtures, whether it is for a single user or has multiple stalls.

Portable toilet facilities on a site or in the public right-of-way should also be accessible; at least one unit in each cluster should meet ADA standards. Many of the units that are currently manufactured do not meet accessibility criteria, particularly with respect to turning space. Agencies responsible for the temporary rental of such facilities should compare portable unit specifications to the requirements of accessibility guidelines.

3.6.5 Pedestrian Signage

Pedestrian and street signage that complies with MUTCD will meet most accessibility criteria for character proportion, character height, and contrast, features that are important to pedestrians who have vision impairments. Accessibility standards also require a matte or other nonglare finish (note that non-glare finishes are not incompatible with requirements for reflectivity). Protruding signs must be posted high enough—80 inches (2030 mm) above the finished surface in ADAAG and 84 inches (2130 mm) in MUTCD—to clear pedestrian routes or be located out of the circulation route. Street signs with large letters are useful to pedestrians who have low vision, because it is usually not possible to view the signs closely.

Pedestrian signals at street crossings should provide a clear distinction between WALK and DON'T WALK symbols and should have colors identifiable by readers who have low vision. These pedestrians often find it necessary to use traffic signals on the sidewalk from which they are departing, because pedestrian signals are not distinguishable across a four-lane roadway. Audible or vibrotactile indicators can make such signals more useful to pedestrians who have vision impairments.

Lighting can greatly enhance the accessibility of signs and other orientation information, including crosswalks, curb and curb ramp markings, and barriers and hazard indicators.



45

Sidewalk toilets: San Francisco

Several U.S. cities are testing the use of accessible self-cleaning sidewalk toilet facilities, operated by coin or token, and supported by the sale of kiosk advertising. Each permanently-installed toilet should meet accessibility criteria. Where portable units are clustered, 1 in 20 (5%) should be accessible.

CLEAR FLOOR OR GROUND AREA

- ✓ 30" x 48" (760 x 1220 mm) wheelchair space, oriented for forward or side reach
- ✓ 48" (1220 mm) maximum forward high reach
- ✓ 54" (1370 mm) maximum side high reach
- ✓ extra room for maneuvering into confined areas
- ✓ accessible surface

BUS STOPS AND SHELTERS

- ✓ 96" (2440 mm) long x 60" (1525 mm) wide minimum
- ✓ slope same as roadway
- ✓ accessible route to and into shelter
- ✓ clear floor space 30" x 48" (760 x 1220 mm) fully within shelter
- ✓ legible signage

ADAAG 10.2.2**Bus Stop Siting and Alterations.**

(1) Bus stop sites shall be chosen such that, to the maximum extent practicable, the areas where lifts or ramps are to be deployed comply with section 10.2.1(1) and (2).

"What are walkways?"

Pedestrian walkways include locations where access is required for use of public transportation, such as bus stops that are not located at intersections or crosswalks."

–DOJ Title II Technical Assistance Manual

The Transit Authority of River City (Louisville, KY) has made funds available to the city to improve sidewalk accessibility for transit users. The city has also installed accessible pedestrian signals at key intersections.

ADAAG 10.2 Bus Stops and Terminals. New Construction.

(1) Where new bus stop pads are constructed at bus stops, bays, or other areas where a lift or a ramp is to be deployed, they shall have a firm, stable surface; a minimum clear length of 96 inches (measured from the curb or vehicle roadway edge) and a minimum clear width of 60 inches (measured parallel to the vehicle roadway) to the maximum extent allowed by

3.6.6 Bus Stops

Bus stops and shelters are covered as transportation facilities in accessibility guidelines adopted by DOT as part of the title II regulation (49 CFR Parts 27, 37, and 38). A route to and into a shelter and the size of a bus stop pad for the deployment of onboard ramps or lifts are regulated (SEE FIGURE 46). Bus route identification signs should meet readability criteria, although tactile signs are not required. Infra-red pedestrian signal technology has been used in some cities to label bus stops and routes for pedestrians who use a hand-held receiver. DOT's ADA regulations require that bus stop locations be audibly and visibly announced on the vehicle.

Transportation stops are considered pedestrian walkways and require curb ramps under the DOJ title II regulation. Because parked cars, traffic, and other conditions can make it impossible for a bus to pull up to a curb along its full length in order to deploy a lift or ramp, a bus stop should be served by a curb ramp so that a passenger may board or exit in the roadway when necessary. Curb ramps at the intersections where the bus stop is located will usually satisfy this requirement, although a curb ramp at the stop may be needed in some locations, particularly at midblock stops and in bus queues.

A common design problem is the location of a new shelter that does not provide adequate maneuvering space for access to and into the enclosure by pedestrians who use wheelchairs. Often, the route into the shelter is obstructed by a waste receptacle or sign. Other shelters are located too close to the edge of the sidewalk to enter without risk of a drop off. Some are located so that the entry route passes over a landscaping strip or tree box where the soil level creates a drop off (SEE FIGURE 47). In systems and on routes where only some buses are accessible, a passenger may be delayed a considerable period of time before boarding and should have shelter while waiting.

3.6.7 Miscellaneous Items

Other items commonly found on sidewalks—fire pullstations, mailboxes (including curbside receptacles for overnight delivery services), information and sales kiosks, and fixed vending machines—should meet basic accessibility requirements for approach, reach range, and operating force and control. Sidewalk passage should not be narrowed by the placement or installation of such items, particularly at turns and ramps and in places that

**46****Bus stops**

Because busses are not always able to pull up to the curb to deploy a lift, it is useful to have a curb ramp at each bus stop that is not immediately adjacent to a corner curb ramp. This will permit a passenger who uses a wheelchair to board from the street if necessary.



47

Bus stops

An accessible route to and into a bus shelter is required by the title II transportation guidelines. Access to this shelter requires travel over a portion of the tree box, where settlement of the soil creates a dangerous drop-off. At the other side, the tree is too close to the shelter--at least 32 inches (815 mm) is necessary for passage at a point.

legal or site constraints; and shall be connected to streets, sidewalks, or pedestrian paths by an accessible route complying with 4.3 and 4.4. The slope of the pad parallel to the roadway shall, to the extent practicable, be the same as the roadway. For water drainage, a maximum slope of 1:50 (2%) perpendicular to the roadway is allowed.

(2) Where provided, new or replaced bus shelters shall be installed or positioned so as to permit a wheelchair or mobility aid user to enter from the public way and to reach a location having a minimum clear floor area of 30 inches by 48 inches entirely within the perimeter of the shelter. Such shelters shall be connected by an accessible route to the boarding area provided under paragraph (1) of this section.

(3) Where provided, all new bus route identification signs shall comply with 4.30.5. In addition, to the maximum extent practicable, all new bus route identification signs shall comply with 4.30.2 and 4.30.3...

The City of San Francisco has policies covering construction barricades, scaffolding, sidewalk tables and chairs, and sub-sidewalk basements that include requirements for pedestrians with vision impairments.

ADAAG 4.11(4) Temporary Structures.

These guidelines cover temporary buildings and facilities as well as permanent facilities [...] Examples of temporary buildings or facilities covered by these guidelines include, but are not limited to: reviewing stands [...], bleacher areas, exhibit areas [...], or temporary safe pedestrian passage around a construction site.

require additional maneuvering space to operate an element or feature.

3.7 Temporary Facilities

3.7.1 Temporary Facilities

Facilities and events that temporarily occupy the public right-of-way are not exempted from accessibility requirements (SEE FIGURES 48, 49 AND 50). A street fair, viewing stands along a parade route, the kiosk of a street vendor, and other temporary facilities should all conform to accessibility requirements to the extent that they are covered by title II or title III. Temporary facilities that are part of the construction process itself are exempted.

3.7.2 Temporary Access

In locations where a continuous sidewalk or street crossing route cannot be provided for pedestrians—for example, when construction barricades intervene—an alternate route should be available. This may require temporary walkways and curb ramps to maintain access to addresses along a sidewalk obstructed for more than a short time (SEE FIGURE 51).

Sidewalk barriers should be detectable by blind pedestrians or those who have low vision. Plastic tape, movable cones, and print signs at a sidewalk excavation will not generally provide adequate notice or protection. Accessibility provisions for protruding objects and construction barrier criteria in MUTCD offer helpful guidance in this area.



48

Temporary facilities

Street fairs, festivals, parades, and other temporary events must be accessible. These photographs show how commonly this is overlooked.



49

Temporary facilities

Jurisdictions that license private entities to use sidewalks for retail or other purposes should include accessibility provisions in their standards.



50

Temporary facilities

ADAAG Appendix: A4.6.3 Parking Spaces.

The increasing use of vans with side-mounted lifts or ramps...has necessitated some revisions in specifications for parking spaces and adjacent access aisles. The typical accessible parking space is 96 in (2440 mm) wide with an adjacent 60 in (1525 mm) access aisle. However, this aisle does not permit lifts or ramps to be deployed and still leave room for a person using a wheelchair or other mobility aid to exit the platform or ramp...The "van accessible" parking space required by these guidelines provides a 96 in (2440 mm) wide space with a 96 in (2440 mm) adjacent access aisle which is just wide enough to maneuver and exit from a side-mounted lift. If a 96 in (2440 mm) access aisle is placed between two spaces, two "van accessible" spaces are created. Alternatively, if the wide access aisle is provided at the end of a row...it may be possible to provide the wide access aisle without additional space...A sign is needed to alert van users to the presence of the wider aisle, but the space is not intended to be restricted only to vans.[...] An essential consideration for any design is having the access aisle level with the parking space. Since a person with a disability, using a lift or ramp, must maneuver within the access aisle, the aisle cannot include a ramp or sloped area. The access aisle must be connected to an accessible route to the appropriate entrance to a building or facility. The parking access aisle must either blend with the accessible route or have a curb ramp complying with 4.7. Such a curb ramp opening must be located within the access aisle boundaries, not within the parking space boundaries. Unfortunately, many facilities are designed with a ramp that is blocked when any vehicle parks in the accessible space. Also, the required dimensions of the access aisle cannot be restricted by planters, curbs, or wheel stops.

3.8 Vehicular Ways and Facilities**3.8.1 On-Street Parking**

Just as the provision of pedestrian circulation on and along sidewalks constitutes a "program" of a title II entity, so too may the provision of on-street parking by a city or town be a program covered by title II. This is particularly true if the local government does not provide any other public parking in a garage or lot. For many addresses, on-street parking offers the most convenient access.

3.8.2 Scoping

It is difficult to be precise in recommending scoping for the number of accessible spaces that should be provided in new construction or alteration projects that include on-street parking. Accessibility scoping for parking lots and garages offers some guidance, but it is not directly applicable to urban blocks or suburban strips. A municipal policy of providing one accessible space per developed block face, in commercial areas where parking is controlled by meters, time limits, or similar regulation, is recommended. In residential areas, citizen requests may establish need and should be coordinated with the provision of curb ramps. The inventory of existing accessible on- and off-street public spaces and opportunities to designate accessible spaces where street slopes are minimal may also be factors.

Where parallel parking is already provided, accessible spaces can be designated at the head and foot of a block to take advantage of existing curb ramp access (SEE FIGURE 52). Locations at or near intersections are also more likely to have minimal street slopes and will be more usable by drivers and passengers who transfer between vehicles and wheelchairs. Spaces at the foot of a block can also accommodate vans that have rear-loading lifts and cars that have rear scooter hoists. If the sidewalk adjacent to an accessible space is unencumbered with plantings, benches, and signposts, vans can deploy side lifts directly on the sidewalk.

Some pedestrians with disabilities who are ambulatory will need accessible parking spaces close to a specific building or facility. Planners should consider providing accessible spaces--and curb ramps--at midblock or in other locations to provide a short or direct route to certain accessible entrances.

3.8.3 Parallel Parking



51

Temporary access: Albuquerque, NM

This downtown revitalization project included plywood ramps and sidewalks to maintain pedestrian access to businesses during construction.



52

Accessible on-street parallel parking: Alexandria, VA

Existing on-street parking is signed for accessible use. A thirteen-foot-wide (3965 mm) curb lane can accommodate an eight-foot (2440 mm) vehicle aisle and a five-foot (1525 mm) access aisle.

In Rockville, MD, accessible on-street parking is provided in a 13-foot-deep recess that allows the access aisle to be located on either the driver or passenger side of the vehicle. Two spaces are grouped, with curb ramps at the head and foot of the recess.

An Oakland, CA policy permits the city to designate resident-only 'blue zone' parking in front of the homes of people with disabilities.

ADAAG 4.1.2(5)(a) Accessible Sites and Exterior Facilities: New Construction.

If parking spaces are provided for self-parking by employees or visitors, or both, then accessible spaces complying with 4.6 shall be provided in each such parking area in conformance with the table below...

Total Parking in Lot	Minimum Number of Accessible Spaces
1-25	1
26-50	2
51-75	3
76-100	4
101-150	5
[...]	

In the historic downtown of Edenton, NC, accessible angled parking is provided at the head and foot of the block. Curb ramps are installed in bulbouts at each intersection.

PASSENGER LOADING ZONES

- ✓ 20-foot-long (6.1 m) level access aisle
- ✓ curb ramp
- ✓ 114" (2.9 m) overhead clearance at loading zones
- ✓ sidewalk clear for lift deployment
- ✓ mounted signage

Although ADAAG does not contain technical specifications for accessible parallel parking, a curb lane that is 13 feet (4 m) wide can accommodate an 8-foot (2440-mm) vehicle width and a 5-foot (1525-mm) access aisle. A curb ramp at the head or foot of the space can then provide access to the sidewalk. If the accessible space is adjacent to the street crossing, an existing corner curb ramp may serve it adequately. Sidewalk extensions—neckdowns or bulbouts—used to shorten street crossings or provide traffic calming, can also shelter the access aisle needed for fully usable on-street transfer from vehicle seat to wheelchair. Standard accessible parking signs should be installed. Several State accessibility codes have illustrated on-street spaces with access aisles inset into the sidewalk in the manner of loading-zone construction (SEE FIGURES 53 AND 54).

3.8.4 Other On-Street Parking

Perpendicular and angled on-street parking can be designed and constructed according to accessible parking space provisions (SEE FIGURE 55). Where one-way traffic prevails, it may be necessary to increase the number of access aisles provided or permit backing into the space to locate the access aisle on the side of the vehicle where it is needed. One in every eight accessible spaces should be van accessible, with an access aisle that is 8 feet (2440 mm) wide.

3.8.5 Loading Zones

Accessible design standards for passenger loading zones can be applied at many building entrances by including a curb ramp in front of the building and planning for adequate headroom where there is a canopy or other building element overhead. An access aisle for a vehicle lift can be provided on the sidewalk, if it is clear of obstructions, or a portion of the parking or driving lane may be used, where permitted, for vehicle-to-wheelchair transfer.

3.8.6 Speed Bumps

Drivers with disabilities report that a speed bump (or hump) is a barrier to roadway use, not merely an inconvenience. The jarring that can occur at even low speeds can be painful or dangerous. Other traffic calming approaches should be considered where feasible.

3.8.7 Callboxes



53

Accessible on-street parallel parking: Rockville, MD

Two accessible parking spaces are provided with a choice of driver- or passenger-side access aisles in this streetscape improvement project.



54

Accessible on-street parking

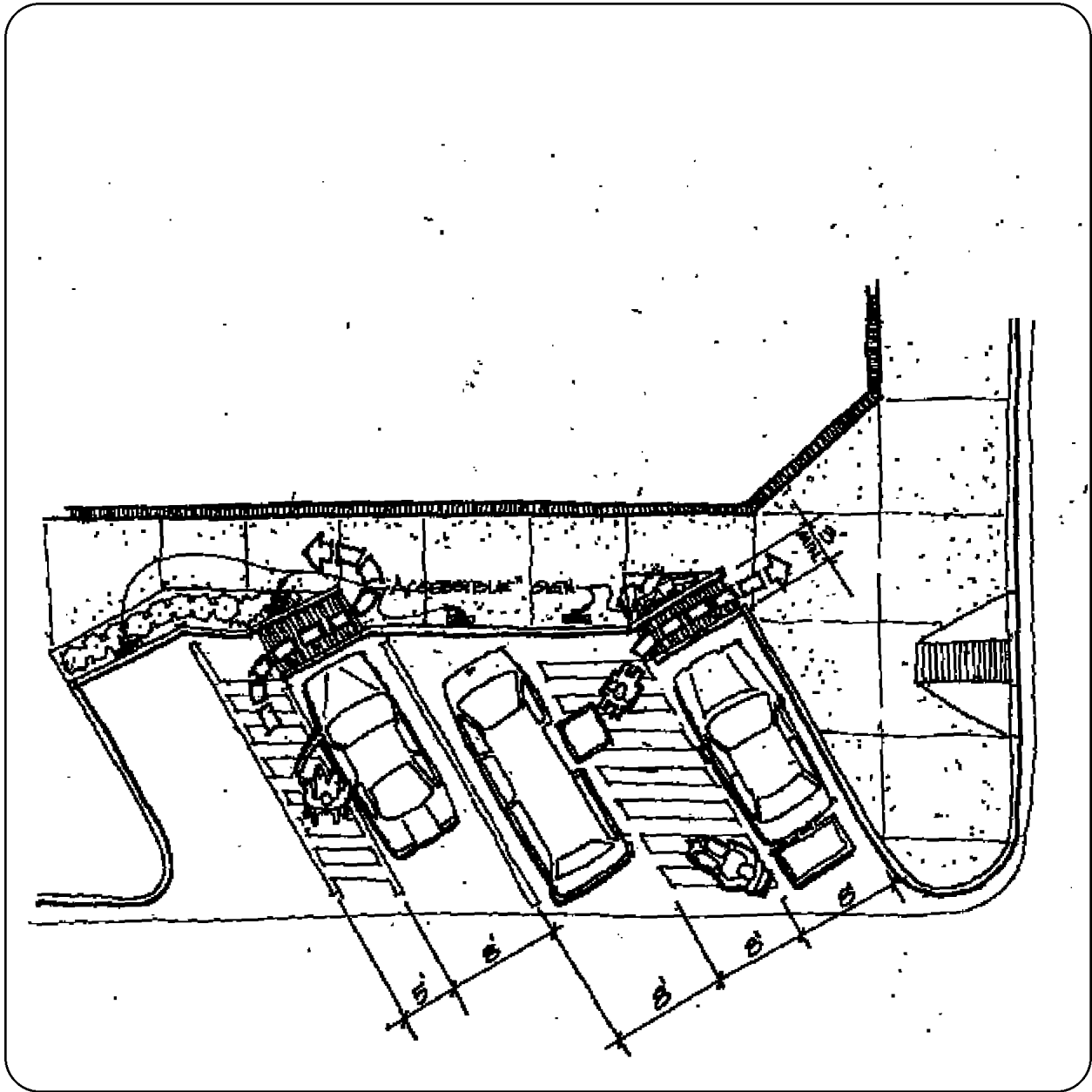

55

Accessible on-street parking

On-street accessible parallel and angled parking can be designed using the guidelines for perpendicular lot and garage spaces. These include five-foot-wide (1525 mm) access aisles at street level and curb ramps connecting to the sidewalk.

PARALLEL PARKING

- ✓ level access aisle full length of parking space
- ✓ curb ramp in sidewalk
- ✓ mounted signage
- ✓ sidewalk clear for lift deployment

The State of California is retrofitting all callboxes with TTYs

CALLBOXES

- ✓ accessible reach ranges at controls:
 - 48" (1220 mm) maximum AFF for front approach
 - 54" (1370 mm) maximum AFF for side approach
- ✓ accessible operation
- ✓ operable with one hand
- ✓ no tight grasping or twisting
- ✓ limited operating force
- ✓ communications accessibility
- ✓ operation should not require voice

In Ventura County, CA, callboxes that incorporate a TTY are currently being installed in some locations. Arizona state regulations require that all roadside callboxes incorporate TTYs. Virginia and Illinois provides public TTY access at every rest area throughout the state.

Although the need for roadside callbox systems is rapidly being diminished by the availability of cellular telephones (some new car manufacturers already include car telephones), it is likely that current systems will be maintained and, perhaps, even expanded for some years. Where callboxes are installed as a program of a State or local government, drivers with disabilities—both those who use wheelchairs and those who do not communicate by voice—must have a means to take advantage of the emergency help they offer.

Several jurisdictions now require that TTYs be installed at roadside callboxes. It is less common to provide callboxes that are physically accessible for a person who uses a wheelchair. Providers have voiced concerns about the safety of people with disabilities traveling on or along the shoulder of a high-speed roadway. It is true that pedestrian use of the breakdown lane can be dangerous, but people who use wheelchairs have expressed the need to have the same options to seek help as other drivers and have taken action, including filing lawsuits, to ensure the availability of those options. To be accessible to a pedestrian who uses a wheelchair, a callbox must be approachable from the shoulder without obstruction and should be mounted so that its highest operable part does not exceed side- or front-reach range limits. FHWA has indicated that boxes mounted at that height on breakaway supports do not pose a breakaway hazard to drivers. Manufacturers caution that care must be taken to ensure that snow is not plowed under or over callboxes installed at lower heights.

3.9 Accessible Design Resources

3.9.1 Publications

FHWA-sponsored research conducted in the early 1980s resulted in the publication of several pedestrian manuals that recommend accessible design criteria. The 1989 FHWA publication Handbook on Planning, Design, and Maintenance of Pedestrian Facilities (Zegeer, et al.) was the first to integrate accessibility and general pedestrian considerations. Its design recommendations are generally consistent with ADAAG and UFAS provisions and with this guide.

Recently, as part of the National Highway System Designation Act of 1995, FHWA issued an interim final rule adopting design standards promulgated by AASHTO in its 1995 edition of A Policy on Geometric Design of Highways and Streets. Chapter II (Design Controls and Criteria) of the "Green Book," as it is known, contains a discussion on designing to meet the needs of people with disabilities that reflects ADA implementing regulations. Chapter IV (Cross Section Elements) also refers to some accessibility criteria.

Industry organizations, including AASHTO, the American Society of Civil Engineers, the Institute of Transportation Engineers (ITE), the American Public Works Association (APWA), the National Committee on Uniform Traffic Control Devices, and others, have begun to incorporate appropriate accessibility provisions in organization guidelines and good practice recommendations as they are updated. Recent publications include "Design and Safety of Pedestrian Facilities" (ITE Technical Committee 5A-5, 1998) and "Standard Plans for Public Works Construction" (APWA, 1994). Changes in chapters on markings, signals, and traffic-control devices at railroad-highway grade crossings in MUTCD will be undertaken in 2000. Disability organizations are expected to provide detailed comment in several areas, particularly on accessible pedestrian signals.

TEA-21 legislation requires that FHWA, in concert with AASHTO and ITE, develop guidance on pedestrian and bicycle design and construction, including accessibility features. A joint industry/consumer task force will assist. AASHTO has proposed to undertake the development of Pedestrian Guidelines over the next two years. A National Cooperative Highway Research Program (NCHRP) project on the planning, design, and operation of pedestrian facilities, including requirements for accessibility, is also underway.

3.9.2 Technical Assistance

Questions about the design of accessible public rights-of-way and related pedestrian facilities may be addressed to the following DOT offices:

- **FHWA Office of Civil Rights**
202/366-0693 (V) or 202/366-5751 (TTY)
ADA and Section 504 enforcement and technical assistance relating to curb ramps, sidewalks and other pedestrian-related facilities
- **FHWA Office of Engineering, Federal-aid and Design Division, Geometric, Safety and Design Group**
202/366-0494 (V)
Design issues relating to curb ramps, sidewalks and streets

- **FHWA Office of Environment and Planning, Bicycle and Pedestrian Programs**

202-366-4634 (V)

TEA-21, the highway planning process, and general bicycle and pedestrian issues

- **FTA Office of Civil Rights**

888/446-4511 (V); 202/366-4018 (V); 202/366-0153 (TTY)

ADA and Section 504 technical assistance and enforcement relating to buses, paratransit, and commuter trains

- **FTA Office of Planning**

202/366-4033 (V)

TEA-21, the transit planning process, and Livable Communities

- **Departmental Office of Civil Rights**

202/366-4648 (V); 202/366-8538 (TTY)

General technical assistance and enforcement on civil rights issues relating to transportation

Compliance and enforcement issues and questions about program accessibility in existing facilities should be directed to the Department of Justice ADA information line at 800/514-0301 (V) or 800/514-0383 (TTY). Copies of the DOJ title II regulation may be ordered through the same telephone number. The Department also publishes a Title II Technical Assistance Manual (DOJ TA Manual) and a quarterly enforcement report. The DOJ ADA website can be found at: www.usdoj.gov/crt/ada/adahom1.htm.

Questions about the ADA Accessibility Guidelines, including future rulemaking on public rights-of-way accessibility, should be addressed to the Access Board technical assistance (TA) line at 800/872-2253 (V) or 800/993-2822 (TTY) between 10:00 a.m. and 5:30 Monday through Friday (no technical assistance after 2:00 pm on Wednesdays). Requests may also be faxed to the Board at 202/272-5447 (F). Copies of ADAAG may be obtained through the same Access Board information line. Also available are

a series of technical bulletins on ADAAG provisions; ADAAG and UFAS manuals and checklists; a nine-part transit manual for system administrators; an accessibility newsletter; several research publications, including the report of the Recreation Advisory Committee; and copies of Access Board rulemaking notices. A four-part training videotape, "Accessible Sidewalks: Design Issues for Pedestrians with Disabilities" is available on request.

Many Access Board documents, including ADAAG, can be downloaded from the Board's website at: <http://www.access-board.gov>. Arrangements can be made through the Access Board for specialized training for design professionals, transportation engineers and planners, and others responsible for applying accessibility guidelines to new construction and alterations.

PLANNING AND FUNDING UNDER TEA-21

Background and Role of TEA-21

More than \$100 billion is spent every year on our nation's highways by all units of government. This remarkable annual investment in roads is financed from a variety of Federal, State and local sources, including user fees, general funds, bond issues, and toll revenues. The Federal government collects approximately one-quarter of these funds through the Federal gasoline tax and redistributes almost all of the money that is generated to States and metropolitan areas to spend on their priorities, within certain programs and funding categories.

The Transportation Equity Act for the 21st Century (TEA-21), signed into law on June 9, 1998, determines the program areas and funding categories, in particular by defining what kind of activities are eligible for different pots of federal money. TEA-21 is one in a long line of transportation laws that, since 1956, has helped direct and lead transportation expenditures in the United States at the Federal, State and local level. In addition to setting funding priorities, the law also sets out certain planning and policy requirements for States and metropolitan areas.

Funding Opportunities for ADA Improvements

Most of the major categories of funding in TEA-21 can be used to build or retrofit sidewalks, crosswalks, and other accessible pedestrian facilities such as trails. Major funding sources include:

1. National Highway System. Accessible pedestrian facilities can be constructed as part of, or independent of, projects on the National Highway System (comprising 150,000 miles of Interstates and major US routes identified by States). Facilities may be in or across Interstate rights-of-way.
2. Surface Transportation Program (STP). TEA-21's largest single program provides States with funds for their own surface transportation priorities, which may be highway, transit, bicycle or pedestrian facilities. The law specifically identifies the retrofitting of sidewalks to comply with the Americans with Disabilities Act as an eligible activity for these funds.
3. Transportation Enhancements set-aside. Ten percent of the STP is

dedicated to 14 types of activity that are designed to enhance the traveling experience and opportunities including historic preservation, bicycle and trail facilities, and pedestrian facilities such as sidewalks. Every State administers this program slightly differently and this may affect the eligibility of sidewalk projects.

4. Safety set-aside. Another ten percent of the STP is dedicated to improving hazardous locations on the highway system, including features that are dangerous for pedestrians. Activities that might be funded as part of the Hazard Elimination Program include improved lighting, the removal of dangerous obstacles (poles, utilities etc) and the installation of new crossing facilities. Traffic calming activities were specifically identified as eligible by TEA-21.
5. Congestion Mitigation and Air Quality Program (CMAQ). The CMAQ funds are targeted at activities that will help reduce congestion and pollution in metropolitan areas that fail to meet Federal air quality standards. Pedestrian improvements are eligible for this category of funding, as encouraging walking may reduce the amount of vehicle travel.
6. Recreational Trails Program. This program provides funds to States to develop and maintain recreational trails and trail-related facilities for both motorized and non-motorized recreational trail uses.
7. Transit Enhancements. One percent of the Urbanized Area Formula Grant transit funds apportioned to each metropolitan area of more than 200,000 population must be used for 'transit enhancements activities' such as enhanced access for people with disabilities.
8. Pedestrian facilities are eligible for a variety of other funds including Federal Lands Highway, Scenic Byways, and Transit programs. Pedestrian-related planning and safety activities are also eligible activities under different programs in TEA-21.

All of these programs confer eligibility for funding on pedestrian-related projects and activities. However, few of the programs have any guaranteed minimum amount of funding that must go to improving access for people with disabilities -- the decisions as to what gets funded and what does not

are made at the State DOT and Metropolitan Planning Organization (MPO) level and the choices are made as part of a prescribed planning process that is described below. People or agencies seeking funding should note that Federal funds can only be used for projects that are in an approved State or MPO Transportation Improvement Program (TIP).

Those seeking funding should also note that funding for specific improvements can either be approved as an independent or stand-alone project, as an incidental part of a larger transportation project, or as part of a grouped type or list of similar activities (such as an annual program to improve a certain number of intersections to include curb cuts and crosswalks).

TEA-21 Planning Process

The transportation planning process established in 1991 as part of the Intermodal Surface Transportation Efficiency Act is continued by the Transportation Equity Act for the 21st Century. States and metropolitan areas (with populations of more than 50,000) are required to plan for the “development and integrated management and operation of transportation systems and facilities (including pedestrian walkways and bicycle transportation facilities) that will function as an intermodal transportation system...”

The planning process for both States and metropolitan areas is further required to consider projects and strategies that will increase the safety and security of the transportation system for nonmotorized users; increase accessibility and mobility options available to people; improve the quality of life; and enhance the integration and connectivity of the transportation system for people. States and MPOs are required to produce two basic planning documents: a Long-range Transportation Plan and a Transportation Improvement Program (TIP). The Long-range Transportation Plans have at least a 20-year horizon and must be regularly updated (every three years in metropolitan areas that do not meet federal air quality standards; every five years in other metropolitan areas; and “periodically” in States). The TIPs must list approved projects for which there is identified funding for each of the following three years, and must be updated at least every two years.

The Long-range Transportation Plans set the long term direction for transportation investment and typically include a broad vision statement, long-term goals and objectives, policy statements and priority areas for the State or metropolitan area. They may identify specific projects (such as road improvements or new transit construction), important corridors that need study, or programmatic areas (such as improving access for people with disabilities) that will receive special attention. Coverage of pedestrian issues may be integrated into the overall transportation plan or contained in a separate pedestrian plan that is incorporated by reference into the overall plan. In the latter instance, a separate pedestrian plan may well contain planning and design guidance related to sidewalks, crosswalks and other pedestrian facilities that will essentially determine how pedestrian infrastructure is developed in the years ahead.

The TIPs are quite different documents as they usually are little more than a long list of the specific projects that are going to be undertaken by the State or MPO in each of the following three years, each with a short description of the actions to be taken. Every project in the TIP must be consistent with projects, programs or policies contained in the long range plan and must have an identified source of funding.

The Long-range Transportation Plans and TIPs must be developed and approved through a process that gives the public, affected groups and agencies notice of and a reasonable opportunity to comment on the plans as they are developed. There are detailed federal guidance documents which outline the kind of public involvement activities that are sufficient to provide appropriate notice and opportunity for people to participate in the planning process, but there are few firm requirements that can be enforced.

At a minimum, public involvement should be "proactive and provide complete information, timely public notice, full public access to key decisions, and opportunities for early and continuing involvement..." (23 CFR 450.212 (a)), and must provide for:

- a) early and continuing public involvement throughout the transportation planing and programming process;

- b) timely information about transportation issues and processes to citizens;
- c) reasonable public access to technical and policy information used in the development of Statewide and metropolitan plans and TIPs;
- d) adequate public notice of public involvement activities and time for public review and comment at key decision points, including but not limited to action on the plan and TIP;
- e) a process for demonstrating explicit consideration and response to public input during the planning and program development process;
- f) a process for seeking out and considering the needs of those traditionally underserved by existing transportation systems, such as low income and minority households which may face challenges accessing employment and other amenities, and
- g) periodic review of the effectiveness of the public involvement process to ensure that the process provides full and open access to all and revisions to the process as necessary.

ACCESSIBLE DESIGN RESOURCES for PEDESTRIAN FACILITIES

State and local government facilities and programs are covered by title II of the Americans with Disabilities Act of 1990 (ADA); private sector facilities are covered by title III. Federal facilities and programs are subject to the Architectural Barriers Act of 1968 (ABA) and the Rehabilitation Act of 1973 (often called '504'). In addition to ADA title II coverage, Federally-assisted state and local government programs may also be subject to the Rehabilitation Act. Private sector facilities are subject to title III of the ADA.

State and local governments may choose to follow either the ADA Accessibility Guidelines (ADAAG) or the Uniform Federal Accessibility Standards (UFAS) for new construction and alterations under the ADA. UFAS is also the standard for ABA and Rehabilitation Act coverage (although many Federal agencies have directed that ADAAG be used where it provides a higher degree of accessibility). ADAAG is the only standard for title III (private sector) facilities.

Copies of the US Department of Justice (DOJ) ADA title II and title III regulations and their companion Technical Assistance Manuals can be obtained from DOJ by calling 800/514-0301 (V) or 800/514-0383 (TTY). Copies of UFAS and ADAAG may be obtained from the US Architectural and Transportation Barriers Compliance Board (the Access Board) via its toll-free technical assistance line at 800/872-2253 (V) or 800/993-2822 (TTY).

Other accessibility resources with application to pedestrian facilities include:

Design and Safety of Pedestrian Facilities

A Recommended Practice of the Institute of Transportation Engineers

ITE Technical Committee 5A-5 (1998)

Institute of Transportation Engineers

525 School Street, SW

Suite 410

Washington, DC 20024-2797

202/554-8050 (V)

--see Chapter 2: 'Pedestrians with Disabilities'

Sidewalk and Curb Ramp Design

State of New Mexico
Governor's Committee on Concerns of the Handicapped
Lamy Building, Room 117
491 Old Santa Fe Trail
Santa Fe, NM 87503
505/827-6465 (V); 505/827-6329 (TTY); 505/827-6328 (F)

A Working Approach to Accessibility in Public Rights-of-Way

Montana Department of Transportation
Darren Kaihlanen and Scott A. Keller, PE
MDT/MSU Design Section
204 Cobleigh Hall

Bozeman, MT 59717-3900
406/994-1843 (V); 406/994-1870 (F)
--curb ramp designs in Microstation CADD and Adobe Acrobat available at
MDT website: <http://www.mdt.state.mt.us>

Designing Sidewalks for People Who Use Wheelchairs

Beneficial Designs, Inc.
5858 Empire Grade
Santa Cruz, CA 95060
831/429-8447 (V)

Street Design Guidelines for Blind and Visually Impaired Pedestrians

American Council of the Blind
1155 Fifteenth Street NW, #720
Washington, DC 20005
202/467-5085 (F)

Accessible Sidewalks: Design Issues for Pedestrians with Disabilities (video, TRT 43 minutes)

US Architectural and Transportation Barriers Compliance Board

1331 F Street NW, #1000

Washington, DC 20004

800/872-2253 (V); 800/993-2822 (TTY); 202/272-5447 (F)

--also available: Report of the Recreation Access Advisory Committee

--also available: ADAAG Technical Assistance Manual

Accessible Pedestrian Signals (APS)

Billie Louis Bentzen, PhD and Lee S. Tabor, AIA

Accessible Design for the Blind

PO Box 1212

Berlin, MA 01503

978/838-2307 (V/F)

--synthesis of current (1998) APS technology and practice

--listing of US and foreign manufacturers

--also available from research sponsor, the US Access Board (see above)

ADA Standards for Accessible Design (videotape series)

Center for Universal Design

North Carolina State University, School of Design

Box 8613

Raleigh, NC 27695-8613

800/647-6777 (V/TTY)

Best Practices in Walkway and Trail Design

Beneficial Designs, Inc.

5858 Empire Grade

Santa Cruz, CA 95060

408/429-8447 (V)

--also be available from research sponsor FHWA

Universal Access to Outdoor Recreation: A Design Guide

MIG Communications
1802 Fifth Street
Berkeley, CA 94710

--also available: The Accessibility Checklist: An Evaluation System for Buildings and Outdoor Settings (1993) and Play for All Guidelines: Planning, Design and Management of Outdoor Play Settings for All Children (1993)

Everyone's Nature: Designing Interpretation to Include All (1994)

by Carol Hunter/Colorado Division of Wildlife
Falcon Press Publishing Company
Helena, MT

Design Standards to Accommodate People with Disabilities in Park and Open Space Design

by Michael L. Reis (1991)
University of Wisconsin-Extension
Madison, WI

Trail Intersection Design Guidelines

Wayne E. Pein, University of North Carolina Highway Safety Research Center
available from the UNC Highway Safety Research Center
730 Airport Road, Campus Box 3430
Chapel Hill, NC 27599-8710
919/962-2202 (V)

--also available from research sponsor FHWA

Spotlight on Safety

A series of pedestrian safety brochures sponsored by the Partnership for a Walkable America
Highway Safety Research Center
University of North Carolina
730 Airport Road, Campus Box 3430
Chapel Hill, NC 27599-3430
919/962-2202 (V); 919/962-8710 (F)

ADA Self-Evaluation Handbook for Park Districts

John McGovern
National Parks and Recreation Association
2775 South Quincy Street, Suite 300
Arlington, VA 22206-2204
703/820-4940 (V)
--also available from NRPA: Recreation Access in the 90s Newsletter
(bi-monthly)

Title II Action Guide

Barrier Free Environments/Adaptive Environments Center
available from LRP Publications
Department 400
747 Dresher Road, PO Box 980
Horsham, PA 19044-0980
800/341-7874, x353 (V)

Title II Technical Assistance Manual

U.S. Department of Justice
800/514-0301 (V); 800/514-0383 (TTY)
--also available: 28 CFR Part 35: Nondiscrimination on the Basis of Disability
in State and Local Government Services; Final Rule ("title II")

Park Access Digest (monthly) and other publications and workshops

Whole Access
517 Lincoln Avenue
Redwood City, CA 94061
415/363-2647 (V)

Park Practice Program Publications (three quarterly publications: Trends, Grist, and Design)

National Park Service
PO Box 37127
Washington, DC 20013-7127
202/343-7067 (V)
--see "Accessibilty and Outdoor Recreation" (Trends: v. 33, no. 1, 1996)

Disabled Outdoors Magazine

5223 South Lorel Avenue
Chicago, IL 60638
708/284-2206 (V)

Sports 'n Spokes (bi-monthly magazine)

Paralyzed Veterans of America
2111 East Highland Avenue, #180
Phoenix, AZ 85016-4702
602/224-0500 (V)

**Bicycle and Pedestrian Planning Under ISTEA:
Course #15135**

National Highway Institute
US Department of Transportation/Federal Highway Administration
Arlington, VA
703/285-2186 (V)
--Participant Workbook: Publication # FHWA-HI-94-028 (September 1994)

**Pedestrian and Bicycle Safety and Accommodation:
Course #38061**

National Highway Institute
US Department of Transportation/Federal Highway Administration
Arlington, VA
703/285-2186 (V)

**Introduction to Wheeling and Long Distance Racing
(video)**

Vinland National Center
PO Box 308
Loretto, MN 55357
612/479-3555 (V)

National Wheelchair Athletic Association Videotapes

Wheelchair Athletics of the USA/NWAA
1604 East Pikes Peak Avenue
Colorado Springs, CO 80909
719/635-9300 (V)

ADA TECHNICAL ASSISTANCE

US Architectural and Transportation Barriers Compliance Board (the Access Board)
800/872-2253 (V); 800/993-2822 (TTY); www.access-board.gov

US Department of Justice
800/514-0301 (V); 800/514-0383 (TTY);
www.usdoj.gov/crt/ada/adahom1.htm

US Department of the Interior/National Park Service
(by contract with the National Center on Accessibility at Indiana University)
V/TTY: 800/424-1877

US Department of Transportation
--FHWA Office of Engineering/Federal-aid and Design Division/Geometric,
Safety and Design Group: 202/366-0494
--FHWA Office of Environment and Planning/Bicycle and Pedestrian
Programs:
202/366-4634 (V)
--FHWA Office of Civil Rights: 202/366-0693 (V) or 202/366-5751 (TTY).
--Departmental Office of Civil Rights: 202/366-4648 (V) or 202/366-8538 (TTY)
--FTA Office of Civil Rights: 888/446-4511 (V); 202/366-4018 (V);
202/366-0153 (TTY)
--FTA Office of Planning: 202/366-4033

Regional Disability and Technical Assistance Centers (10 regions)
800/949-4232 (V/TTY)

National Center on Accessibility (in cooperation with the National Park
Service)
800/424-1877 (V/TTY)

CHECKLIST FOR ACCESSIBLE SIDEWALKS AND STREET CROSSINGS

The Americans with Disabilities Act (ADA) requires that new and altered public sidewalks and street crossings be accessible so that people with disabilities can use the pedestrian routes that connect buildings, facilities, and transportation modes. Title II of the ADA covers new sidewalks and streets constructed by or on behalf of a State or local government. The Department of Justice (DOJ) title II regulation specifically requires that curb ramps be provided when sidewalks or streets are newly constructed or altered. Sidewalks and curb ramps covered by title II should comply with the technical standards in ADAAG, UFAS (the 1984 standard for Federal construction), or other accessibility code that meets or exceeds the level of accessibility required under the ADA. Many of the same provisions that govern the accessible route on a building site or within a building, as specified in the ADA Accessibility Guidelines (ADAAG, sections 1-10), can also be applied to public sidewalks. Additional requirements for existing pedestrian networks not otherwise being altered are also included in the DOJ regulation.



CURB RAMPS

- ✓ A curb ramp or other sloped area is required wherever a new or altered pedestrian walkway crosses a curb or other barrier to a street, road, or highway. Similarly, a curb ramp is required wherever a new or altered street intersects a pedestrian walkway. A curb ramp may be perpendicular to the curb it cuts or parallel with the sidewalk. Other designs may also comply, including sidewalks that ramp down to a lesser curb height, combined with a short perpendicular curb ramp at the street.
- ✓ The running slope of a new curb ramp should not exceed 1 in 12 (8.33%). Curb ramps in alterations where it is technically infeasible to meet new construction requirements may have a maximum slope of 1 in 10 (10%).
- ✓ A level landing should be provided at the top of a perpendicular curb ramp. A curb ramp must connect to a travel route that is at least 36 inches (915 mm) wide and has a cross slope of no more than 1:48 (2%). The side flares of a curb ramp do not meet these criteria (the slope of a side flare is limited so that it will not present a tripping hazard to pedestrians).

- ✓ The transition from curb ramp to gutter should be flush. Lips are not permitted. Adjacent counterslopes in the line of travel should not exceed 1 in 20 (5%) and should connect smoothly with other elements of the pedestrian network.
- ✓ The foot of a curb ramp should be contained within the crosswalk markings. Pedestrians who use wheelchairs should not be directed outside the crosswalk or into an active travel lane in order to cross stopped traffic. If a diagonal ramp is used, the 48-inch long (1220 mm) bottom landing should be fully contained within the space between the curb radius and curb line extensions.

SIDEWALKS



- ✓ A new sidewalk should be wider than the minimum accessible travel width of 36 inches (915 mm). Maneuvering space is necessary for a pedestrian using a wheelchair to turn, to pass by other pedestrians, to operate and pass through an entrance door, to use a sidewalk telephone or to activate a pedestrian crossing button. A 60-inch (1525-mm) minimum width can accommodate turns and passing space and is recommended for sidewalks adjacent to curbs in order to provide travel width away from the drop-off at the street edge.
- ✓ The cross slope of a sidewalk should not exceed 1:50 (2%). Excessive cross slope tends to direct wheelchair users into the street. At driveways there should be a 36-inch (915-mm) wide passage with a cross slope of no more than 1:50 (2%). Corners at intersections should comply in both directions, since the running slope of one walkway will be the cross slope of another.
- ✓ Street furniture, plantings, and other fixed items should not protrude into travel routes. Pedestrians with vision impairments can detect objects mounted on walls or posts if their leading edges are at or below 27 inches (685 mm) above the sidewalk.



STREET CROSSINGS

- Consider the information needs of blind and low-vision pedestrians at intersections. Street crossing design should ensure that the boundary between the sidewalk and the street is detectable. Pedestrian crossing information should be available to all users.
- Insufficient crossing time may be a barrier for some pedestrians. Every pedestrian cohort should be expected to contain some walkers whose rate of travel is less than 4.0 feet per second.

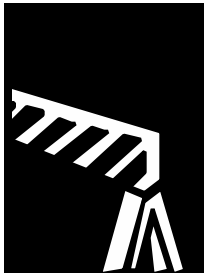

TEMPORARY WORK

- Temporary work should be accessible. Where construction blocks a public sidewalk for more than a short time, an alternate route that includes curb ramps and other accessible features should be provided. Temporary events and facilities, such as street fairs, parades, and vending carts should also meet accessibility criteria. Temporary road signage should not encroach on accessible passage or headroom.

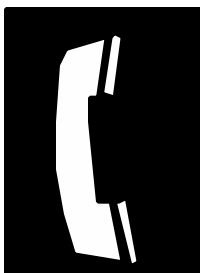

OTHER PEDESTRIAN FEATURES

- Pedestrian facilities on and along sidewalks must be accessible. Signal actuating buttons, drinking fountains, telephones, kiosks, and other pedestrian elements should meet accessibility criteria for approach and maneuvering space, reach range, and controls and operation.

ACKNOWLEDGEMENTS

Accessible Sidewalks and Street Crossings: a Design Guide

Written by: U.S. Access Board and Federal Highway Administration staff

Edited by: Lois Thibault, U.S. Access Board

Illustrations by: Scott Lewendon, LandTech

Designed by: Ziv Gil, Ziv Communications

Particular thanks go to Julie Zirlin, U.S. Department of Transportation, whose commitment made this publication possible and Ellen Harland, AIA, U.S. Department of Justice, whose graphics laid the groundwork for the illustrations.

Many people helped in producing and advising on this publication, among them Nick Artimovich, Andy Clarke, Marguerite Dicenso, Christopher Douwes, John Fegan, Nancy Johnson, and Barbara McMillen (FHWA); Dennis Cannon, Marsha Mazz, Jim Pecht, and Scott Windley (U.S. Access Board), Elizabeth Bacon (DOJ), Bill Hecker, AIA; Jerry Markesino, PE, Ken Kobetsky, PE and AASHTO reviewers, Julie Carroll, Sam Prestipino, Scott Keller, PE, Eric Dibner, and Allan Hockett.

U.S. Architectural and Transportation Barriers Compliance Board

<http://www.access-board.gov>

1331 F Street NW, Suite 1000, Washington, DC 20004-1111

V:202/272-5434

TTY:202/272-5449

FAX:202/272-5447

TECHNICAL ASSISTANCE LINE V:800/872-2253

TTY:800/993-2822

FIGURES

ILLUSTRATIONS

All illustrations are by Scott Lewendon.

Thanks to Bill Hecker, AIA , Jean Tessmer, David Grenier, Tom Pack, and Casey Yanagihara, for concepts illustrated in Figure 11 and to Bill Hecker for Figure 23.

PHOTOGRAPHS

3/Downtown Improvement Program: Auburn, AL (F. Allan Hockett)

5/Protruding objects (Access Board archives)

6/Split sidewalk: Washington, DC (Lois Thibault)

7/Building entrance ramp: Washington, DC (Lois Thibault)

12/Protruding objects (Access Board archives)

27/Transitions (Sam Prestipino)

28/Transitions (Lois Thibault)

29/Transitions (Access Board archives)

30/Transitions (Access Board archives)

33/Raised crossing: Cumberland, MD (Lois Thibault)

34/Elevated sidewalks: Silver City, NM (Eric Dibner)

35/Detectable warnings: Harrisburg, PA (Lois Thibault)

36/Walking speed (Lois Thibault)

38/Curb ramps at splitter island: Washington, DC (Lois Thibault)

39/Pedestrian overpass: La Jolla, CA (Lois Thibault)

40/Elevator access to steeply sloping site: La Jolla, CA (Lois Thibault)

41/Public sidewalk elevator: Lynchburg, VA (F. Allan Hockett)

42/Public sidewalk elevator: Lynchburg, VA (F. Allan Hockett)

43/Sidewalk benches (Access Board archives)

44/Exterior text telephone (Ultratec)

45/Sidewalk toilets: San Francisco (JC Decaux)

46/Bus stops (Lois Thibault)

47/Bus stops (Lois Thibault)

48/Temporary facilities: Washington, DC (Lois Thibault)

49/Temporary facilities (Lois Thibault)

50/Temporary facilities (Lois Thibault)

51/Temporary access: Albuquerque, NM (Lois Thibault)

52/On-street parking: Alexandria, VA (Lois Thibault)

53/Accessible on-street parallel parking: Rockville, MD (Lois Thibault)

54/Accessible on-street parallel parking: Rockville, MD (Lois Thibault)