

MANUAL ON TEMPORARY TRAFFIC CONTROL FOR STREETS AND HIGHWAYS

2006 EDITION



WEST VIRGINIA DEPARTMENT OF TRANSPORTATION
DIVISION OF HIGHWAYS
TRAFFIC ENGINEERING

SEVENTH PRINTING
MAY 2021

THE WEST VIRGINIA DEPARTMENT OF TRANSPORTATION
DIVISION OF HIGHWAYS
CHARLESTON, WEST VIRGINIA

ABSTRACT FROM THE RECORDS OF THE
COMMISSIONER'S ORDERS
DATED

March 9, 2006

Distribution:

AC
CC
CH
HD
DT/
DD
All Districts
FHWA

The Commissioner, upon recommendation of the Director, Traffic Engineering Division, and the concurrence of the Deputy State Highway Engineer - Development, hereby **ORDERS** the **ADOPTION** of the **MANUAL ON TEMPORARY TRAFFIC CONTROL FOR STREETS AND HIGHWAYS**, March 2006 edition, as the official Manual of the West Virginia Department of Transportation, Division of Highways, as required under provisions of Chapter 17C, Article 3, Section 1, of the Official Code of West Virginia, 1931 as amended.

The **MANUAL ON TEMPORARY TRAFFIC CONTROL FOR STREETS AND HIGHWAYS**, March 2006 edition, supersedes and replaces the 1994 edition of the **TRAFFIC CONTROL FOR STREET AND HIGHWAY CONSTRUCTION AND MAINTENANCE OPERATIONS** adopted as the official Manual of the Division of Highways by Commissioner's Order dated November 1, 1994.

NOW, THEREFORE, IT IS **ORDERED**, that the **MANUAL ON TEMPORARY TRAFFIC CONTROL FOR STREETS AND HIGHWAYS**, 2006 edition, be adopted.

Entered this 9th day of March, 2006

Paul A. Mattox, Jr., P. E.
Commissioner of Highways

STATE OF WEST VIRGINIA
WEST VIRGINIA DEPARTMENT OF TRANSPORTATION
DIVISION OF HIGHWAYS

Given under my hand and seal of the Division of Highways, I do hereby certify that the foregoing is a true abstract from the Orders of the West Virginia Commissioner of Highways, entered of record on March 9, 2006.

Division of Highways

TABLE OF CONTENTS

A.	GENERAL.....	1
B.	FUNDAMENTAL PRINCIPLES.....	3
C.	TEMPORARY TRAFFIC CONTROL ELEMENTS.....	8
	C.01 Temporary Traffic Control Plans.....	8
	C.02 Temporary Traffic Control Zones.....	10
	C.03 Components of Temporary Traffic Control Zones.....	10
	C.04 Advance Warning Area.....	10
	C.05 Transition Area.....	12
	C.06 Activity Area.....	13
	C.07 Termination Area.....	14
	C.08 Tapers.....	16
	C.09 Detours and Diversions.....	20
	C.10 One-Lane, Two-Way Traffic Control.....	20
	C.11 Flagger Method of One-Lane, Two-Way Traffic Control.....	20
	C.12 Flag Transfer Method of One-Lane, Two-Way Traffic Control.....	21
	C.13 Pilot Car Method.....	21
	C.14 Temporary Traffic Signal Method.....	21
	C.15 Stop or Yield Control Method.....	22
D.	PEDESTRIAN AND WORKER SAFETY.....	23
	D.01 Pedestrian Considerations.....	23
	D.02 Accessibility Considerations.....	27
	D.03 Worker Safety Considerations.....	29
E.	FLAGGER CONTROL.....	31
	E.01 Qualifications for Flaggers.....	31
	E.02 High-Visibility Clothing.....	31
	E.03 Hand-Signaling Devices.....	32
	E.04 Flagger Procedures.....	33
	E.05 Flagger Stations.....	34
F.	TEMPORARY TRAFFIC CONTROL ZONE DEVICES.....	37
	F.01 Type of Devices.....	37
	F.02 General Characteristics of Signs.....	38
	F.03 Sign Placement.....	39
	F.04 Sign Maintenance.....	41
	F.05 Regulatory Sign Authority.....	41
	F.06 Regulatory Sign Design.....	41
	F.07 Regulatory Sign Applications.....	42
	F.15 Warning Sign Function, Design, and Application.....	48
	F.16 Position of Advance Warning Signs.....	49

F.50	Guide Signs.....	65
F.55	Portable Changeable Message Signs	69
F.56	Arrow Panels.....	71
F.57	High-Level Warning Devices (Flag Trees).....	76
F.58	Channelizing Devices	76
F.59	Cones.....	82
F.60	Tubular Markers.....	83
F.61	Vertical Panels	84
F.62	Drums.....	85
F.63	Type I, II, III Barricades	86
F.65	Temporary Traffic Barriers as Channelizing Devices	88
F.66	Longitudinal Channelizing Barricades	89
F.67	Other Channelizing Devices	90
F.68	Detectable Edging for Pedestrians	90
F.69	Temporary Raised Islands.....	91
F.70	Opposing Traffic Lane Divider.....	92
F.71	Pavement Markings	92
F.72	Temporary Pavement Markers.....	93
F.73	Raised Pavement Markers.....	94
F.74	Delineators	95
F.75	Lighting Devices.....	95
F.76	Floodlights	96
F.77	Flashing Warning Beacons	96
F.78	Warning Lights	97
F.79	Steady-Burn Electric Lamps.....	98
F.80	Temporary Traffic Control Signals.....	98
F.81	Temporary Traffic Barriers.....	101
F.82	Crash Cushions (Impact Attenuators).....	102
F.83	Vehicle Arresting Systems.....	103
F.84	Rumble Strips.....	104
F.85	Screens (Glare Barriers).....	105
G.	TYPE OF TEMPORARY TRAFFIC CONTROL ZONE ACTIVITIES.....	106
G.01	Typical Applications.....	106
G.02	Work Duration	107
G.03	Location of Work.....	110
G.04	Modifications to Fulfill Special Needs	110
G.05	Work Affecting Pedestrian and Bicycle Facilities.....	112
G.06	Work Outside of Shoulder	113
G.07	Work on Shoulder with No Encroachment.....	114
G.08	Work on Shoulder with Minor Encroachment.....	115
G.09	Work within the Median.....	116
G.10	Work within the Traveled Way of Two-Lane Highways	116
G.11	Work within the Traveled Way of Urban Streets	117
G.12	Work within the Traveled Way of Multilane, Nonaccess Controlled Highways	118

G.13	Work within Traveled Way – Intersection.....	120
G.14	Work within Traveled Way – Freeways and Expressways	122
G.15	Two-Lane, Two-Way Traffic on One Roadway of a Normally Divided Highway	123
G.16	Crossovers.....	123
G.17	Interchanges	124
G.19	Work within Vicinity of Highway-Rail Grade Crossings.....	124
G.20	Temporary Traffic Control During Nighttime Hours	125
H.	INTENTIONALLY LEFT BLANK	127
I.	CONTROL OF TRAFFIC THROUGH TRAFFIC INCIDENT MANAGEMENT AREAS.....	128
I.01	General.....	128
I.02	Major Traffic Incidents	129
I.03	Intermediate Traffic Incidents.....	131
I.04	Minor Traffic Incidents.....	132
I.05	Use of Emergency-Vehicle Lighting	132

LIST OF TABLES

C-1	Suggested Advance Warning Sign Spacing.....	12
C-2	Stopping Sight Distance as a Function of Speed	16
C-3	Taper Length Criteria for Temporary Traffic Control Zones	17
C-4	Formulas for Determining Taper Lengths	17
E-1	Stopping Sight Distance as a Function of Speed	36

LIST OF FIGURES

1.	Component parts of a Temporary Traffic Control Zone.....	11
2.	Types of Tapers and Buffer Space.....	15
3.	Example of a One-Lane, Two-Way traffic Taper	19
4.	Use of Hand-Signaling Devices by Flagger.....	35
5.A-C	Commonly used regulatory signs.....	45-47
6.A-F	Warning Signs used in temporary traffic control zones.....	59-64
6.G	Commonly used Guide Signs.....	68
7	Advance Warning Arrow Display Specifications.....	75
8.	Detail "A" Barricades and channelizing devices	78
9.	Detail "B" Sign Mounting for Construction and Maintenance of Operations	79
10.	Detail "C" Temporary Concrete and Guardrail Barrier Placement, Connection and End Protection Details	80
11.	Detail "D" One Lane Closure Using Positive Barrier	81

CASES

Two-Lane, Two-Way Operations

When work is at least 15 ft. from the pavement edge.....	A1
Basic Signing when work limits exceed one mile	A2
Shoulder Occupancy	A3
Partially close lane	A4
Temporary road closure	A5
Short duration work	A6
Mobile operations on shoulder.....	A7
Mobile operations on two-lane road	A8
Pavement widening operation.....	A9
Lane closure for slips & slides (STOP)	A10A
Lane closure for bridge replacement (STOP)	A10B
Lane closure for slips & slides (YIELD)	A11
Road closed with on site diversion	A12

Three-lane, double left run lane two-way traffic, one lane closure.....	A13
Three-lane, climbing lane two-way traffic, one lane closure.....	A14
Moving operation (mowing & spraying)	A15
Partial lane closure for slips & slides.....	A16
Shoulder closures for offset intersections	A17
Work near or in a railroad crossing.....	A18

Intersections Operations

Two-lane, two-way midblock	B1
Multi-lane two-way midblock.....	B2
Multi-lane one-way midblock.....	B3A
Sidewalk Detour or Diversion midblock	B3B
Sidewalk Detour or Diversion at corner	B3C
Intersection closure – two-lane roadway	B4A
Intersection closure – multi-lane roadway.....	B4B
Intersection closure – multi-lane divided roadway.....	B4C
Rural detour signing.....	B5
Urban detour signing for Route	B6
Urban detour signing for closed street.....	B7

Utility Operations

Shoulder closure.....	C1
Lane closure.....	C2
Centerline closure	C3
Median work	C4

Special Operations

Blasting Zone, two-lane.....	D1
Blasting Zone, multilane.....	D2
Survey party activities.....	D3
Paint operation	D4
Temporary traffic signal (overhead)	D5A
Temporary traffic signal (portable).....	D5B

Multilane Facilities

When work is a least 15 ft. from pavement edge.....	E1
Shoulder occupancy	E2
Shoulder occupancy with concrete barrier.....	E3
Single lane closure one daylight or more.....	E4
Double lane closure.....	E5

Multilane – middle lane closures	E6
Mobile operation on multilane road.....	E7
Lane shift on freeway/expressway.....	E8
Median crossover – divided highway	E9
Emergency freeway closure.....	E10
Short term utility crossings of multilane expressways	E11
Close one side – undivided highway	E12
Five lane, double left turn lane, second lane closed.....	E13
Five lane, double left turn lane, middle lane closed.....	E14
Five lane, double left turn lane, middle lane and inside lane closed	E15
Five lane, double left turn lane, middle lane and both inside lanes closed.....	E16
Multilane divided for turning lanes and side road operations	E17

Interchange Ramps

Deceleration lane closure	F1
Partial exit ramp closure	F2
Right lane adjacent to deceleration lane	F3
Median crossover for entrance ramp.....	F4
Closure of initial portion of entrance ramp.....	F5
Closure of final portion of entrance ramp (STOP)	F6
Closure of final portion of entrance ramp (YIELD)	F7
Median crossover for entrance ramp.....	F8

CHAPTER A. GENERAL

Section A.01 General

Standard:

The needs and control of all road users (motorists, bicyclists, and pedestrians within the highway including persons with disabilities in accordance with the Americans with Disabilities Act of 1990 (ADA), Title II, Paragraph 35.130) through the temporary traffic control zone shall be an essential part of highway construction, utility work, maintenance operations, and the management of traffic incidents.

Support:

When the normal function of the roadway is suspended, temporary traffic control planning provides for continuity of the movement of motor vehicle, bicycle, and pedestrian traffic (including accessible passage); transit operations; and access (and accessibility) to property and utilities.

The primary function of temporary traffic control is to provide for the safe and efficient movement of road users through or around temporary traffic control zones while reasonably protecting workers, responders to traffic incidents, and equipment.

Of equal importance to the public traveling through the temporary traffic control zone is the safety of workers performing the many varied tasks within the workspace. Temporary traffic control zones present constantly changing conditions that are unexpected by the road user. This creates an even higher degree of vulnerability for the workers and incident management responders on or near the roadway (see Section D.03). At the same time, the temporary traffic control zone provides for the efficient completion of whatever activity interrupted the normal use of the roadway.

Consideration for road user safety, worker and responder safety, and the efficiency of road user flow is an integral element of every temporary traffic control zone, from planning through completion. A concurrent objective of the temporary traffic control is the efficient construction and maintenance of the highway and the efficient resolution of traffic incidents.

No one set of temporary traffic control devices can satisfy all conditions for a given project or incident. At the same time, defining details that would be adequate to cover all applications is not practical. Instead, this manual displays several diagrams that depict common applications of temporary traffic control devices. The temporary traffic control selected for each situation depends on type of highway, road user conditions, duration of operation, physical constraints, and the nearness of the work space or incident management activity to road users.

Improved road user performance might be realized through a well-prepared public relations effort that covers the nature of the work, the time and duration of its execution, the anticipated effects upon road users, and possible alternate routes and modes of travel. Such programs have been found to result in a significant reduction in the number of road users traveling through the temporary traffic control zone, which reduces the possible number of conflicts.

Standard:

Temporary traffic control plans and devices shall be the responsibility of the authority of a public body or official having jurisdiction for guiding road users. There shall be adequate statutory authority for the implementation and enforcement of needed road user regulations, parking controls, speed zoning, and the management of traffic incidents. Such statutes shall provide sufficient flexibility in the application of temporary traffic control to meet the needs of changing conditions in the temporary traffic control zone.

Support:

Temporary facilities, including safe pedestrian routes around work sites, are also covered by the accessibility requirements of the Americans with Disabilities Act of 1990 (ADA) (Public Law 101-366, 104 Stat. 327, July 26, 1990. 42 USC 12101-12213 (as amended).

Guidance:

The temporary traffic control plan should start in the planning phase and continue through the design, construction, and restoration phases. The temporary traffic control plans and devices should follow the principles set forth in this manual. The management of traffic incidents should follow the principles set forth in Chapter I.

Option:

Temporary traffic control plans may deviate from the cases in this manual to allow for conditions and requirements of a particular site or jurisdiction.

Support:

The criteria of this manual apply to both rural and urban areas. A rural highway is normally characterized by lower volumes, higher speeds, fewer turning conflicts, and less conflict with pedestrians. An urban street is typically characterized by relatively low speeds, wide ranges of road user volumes, narrower roadway lanes, frequent intersections and driveways, significant pedestrian activity, and more businesses and houses.

CHAPTER B. FUNDAMENTALS

Section B.01 Fundamental Principles of Temporary Traffic Control

Standard:

The needs and control of all road users (drivers, bicyclists, and pedestrians within the highway, including persons with disabilities in accordance with the Americans with Disabilities Act of 1990 (ADA), Title II, Paragraph 35.130) through a temporary traffic control zone shall be an essential part of highway construction, utility work, maintenance operations, and the management of traffic incidents.

Support:

Construction, maintenance, utility, and incident zones can all benefit from temporary traffic control to compensate for the unexpected or unusual situations faced by road users. When planning for temporary traffic control in these zones, it can be assumed that it is appropriate for road users to exercise caution. Even though road users are assumed to be using caution, special care is still needed in applying temporary traffic control techniques.

Special plans preparation and coordination with transit, other highway agencies, law enforcement and other emergency units, utilities, schools, and railroad companies might be needed to reduce unexpected and unusual road user operation situations.

During temporary traffic control activities, commercial vehicles might need to follow a different route from passenger vehicles because of bridge, weight, clearance, or geometric restrictions. Also, vehicles carrying hazardous materials might need to follow a different route from other vehicles. The Hazardous Materials and National Network signs are included in Sections 2B.46 and 2B.47, respectively of the "Manual on Uniform Traffic Control Devices."

Experience has shown that following the fundamental principles of this manual will assist road users and help protect workers in the vicinity of temporary traffic control zones.

Guidance:

Road user and worker safety and accessibility in temporary traffic control zones should be an integral and high-priority element of every project from planning through design and construction. Similarly, maintenance and utility work should be planned and conducted with the safety and accessibility of all motorists, bicyclists, pedestrians (including those with disabilities), and workers being considered at all times. If the temporary traffic control zone includes a highway-rail grade crossing, early coordination with the railroad company should take place.

Support:

Formulating specific plans for temporary traffic control at traffic incidents is difficult because of the variety of situations that can arise.

Guidance:

General plans or guidelines should be developed to provide safety for motorists, bicyclists, pedestrians, workers, enforcement/emergency officials, and equipment, with the following factors being considered:

- A. The basic safety principles governing the design of permanent roadways and roadsides should also govern the design of temporary traffic control zones. The goal should be to route road users through such zones using roadway geometrics, roadside features, and temporary traffic control devices as nearly as possible comparable to those for normal highway situations.
- B. A temporary traffic control plan, in detail appropriate to the complexity of the work project or incident, should be prepared and understood by all responsible parties before the site is occupied. Any changes in the temporary traffic control plan should be approved by an official knowledgeable (for example, trained and/or certified) in proper temporary traffic control practices.

Road user movement should be inhibited as little as practical, based on the following considerations:

- A. Temporary traffic control at work and incident sites should be designed on the assumption that drivers will only reduce their speeds if they clearly perceive a need to do so (see Section C.01).
- B. Frequent and abrupt changes in geometrics such as lane narrowing, dropped lanes, or main roadway transitions that require rapid maneuvers, should be avoided.
- C. Provisions should be made for the reasonably safe operation of work, particularly on high-speed, high-volume roadways.
- D. Road users should be encouraged to use alternative routes that do not include temporary traffic control zones.
- E. Bicyclists and pedestrians, including those with disabilities, should be provided with access and reasonably safe passage through the temporary traffic control zone.
- F. Roadway occupancy should be scheduled during off-peak hours and, if necessary, night work should be considered.
- G. Early coordination with officials having jurisdiction over the affected cross streets and providing emergency services should occur before roadway or ramp closings.

Motorists, bicyclists, and pedestrians should be guided in a clear and positive manner while approaching and traversing temporary traffic control zones and incident sites. The following principles should be applied:

- A. Adequate warning, delineation, and channelization should be provided to assist in guiding road users in advance of and through the temporary traffic control zone or incident site by using proper pavement marking, signing, or other devices that are effective under varying conditions. Providing information that is in useable formats by pedestrians with visual disabilities should also be considered.
- B. Temporary traffic control devices inconsistent with intended travel paths through temporary traffic control zones should be removed or covered. However, in intermediate-term stationary, short-term, and mobile operations, where visible permanent devices are inconsistent with intended travel paths, devices that highlight or emphasize the appropriate path should be used. Providing traffic control devices that are accessible to and usable by pedestrians with disabilities should be considered.
- C. Flagging procedures, when used, should provide positive guidance to road users traversing the temporary traffic control zone.

To provide acceptable levels of operations, routine day and night inspections of temporary traffic control elements should be performed as follows:

- A. Individuals who are knowledgeable (for example, trained and/or certified) in the principles of proper temporary traffic control should be assigned responsibility for safety in temporary traffic control zones. The most important duty of these individuals should be to check that all temporary traffic control devices of the project are reasonably consistent with the temporary traffic control plan and are effective in providing safe conditions for drivers, motorists, pedestrians, and workers.
- B. As the work progresses, temporary traffic controls and/or working conditions should be modified in order to provide safe and efficient road user movement and to provide worker safety. The individual responsible for temporary traffic control should have the authority to halt work until applicable or remedial safety measures are taken.
- C. Temporary traffic control zones should be carefully monitored under varying conditions of road user volumes, light, and weather to check that applicable temporary traffic control devices are effective, clearly visible, clean, and in compliance with the temporary traffic control plan.
- D. When warranted, an engineering study should be made (in cooperation with law enforcement officials) of reported crashes occurring within the temporary traffic control zone. Crash records in temporary traffic control zones should be monitored to identify the need for changes in the temporary traffic control zone.

Attention should be given to the maintenance of roadside safety during the life of the temporary traffic control zone by applying the following principles:

- A. To accommodate run-off-the-road incidents, disabled vehicles, or emergency situations, unencumbered roadside recovery areas or clear zones should be provided where practical.
- B. Channelization of road users, drivers, bicyclists, and pedestrians, should be accomplished by the use of pavement markings, signing, and crashworthy, detectable channelizing devices.
- C. Work equipment, workers' private vehicles, materials, and debris should be stored in such a manner to reduce the probability of being impacted by run-off-the-road vehicles.

Each person whose actions affect temporary traffic control zone safety, from the upper-level management through the field workers, should receive training appropriate to the job decisions each individual is required to make. Only those individuals who are trained in proper temporary traffic control practices and have a basic understanding of the principles (established by applicable standards and guidelines, including those of this Manual) should supervise the selection, placement, and maintenance of temporary traffic control devices used for temporary traffic control zones and for incident management.

Good public relations should be maintained by applying the following principles:

- A. The needs of all road users (drivers, bicyclists, and pedestrians) should be assessed such that appropriate advance notice is given and clearly defined alternative paths are provided.
- B. The cooperation of the various news media should be sought in publicizing the existence of and reasons for temporary traffic control zones because news releases can assist in keeping the road users well informed.
- C. The needs of abutting property owners, residents, and businesses should be assessed and appropriate accommodations made.
- D. The needs of emergency service providers (law enforcement, fire, and medical) should be assessed and appropriate coordination and accommodations made.
- E. The needs of railroads and transit should be assessed and appropriate coordination and accommodations made.
- F. The needs of operators of commercial vehicles such as buses and large trucks should be assessed and appropriate accommodations made.

Standard:

Before any new detour or temporary route is opened to traffic, all necessary signs shall be in place.

All temporary traffic control devices shall be removed as soon as practical when they are no longer needed. When work is suspended for short periods of time, temporary traffic control devices that are no longer appropriate shall be removed or covered.

CHAPTER C. TEMPORARY TRAFFIC CONTROL ELEMENTS

Section C.01 Temporary Traffic Control Plans

Standard:

The needs and control of all road users (motorists, bicyclists, and pedestrians within the highway including persons with disabilities in accordance with the Americans with Disabilities Act of 1990 (ADA), Title II, Paragraph 35.130) through a temporary traffic control zone shall be an essential part of highway construction, utility work, maintenance operations, and the management of traffic incidents.

Support:

A temporary traffic control plan describes temporary traffic control measures to be used for facilitating road users through a work zone or an incident area. Temporary traffic control plans play a vital role in providing continuity of safe and efficient road user flow when a work zone, incident, or other event temporarily disrupts normal road user flow. Important auxiliary provisions that cannot conveniently be specified on project plans can easily be incorporated into Special Provisions within the temporary traffic control plan.

Temporary traffic control plans range in scope from being very detailed to simply referencing typical drawings contained in this Manual, West Virginia Division of Highways standard drawings and manuals, or specific drawings contained in the contract documents. The degree of detail in the temporary traffic control plan depends entirely on the nature and complexity of the situation.

Guidance:

Temporary traffic control plans should be prepared by persons knowledgeable (for example, trained and/or certified) about the fundamental principles of temporary traffic control and work activities to be performed. The design, selection and placement of temporary traffic control devices for a temporary traffic control plan should be based on engineering judgment.

Coordination should be made between adjacent or overlapping projects to check that duplicate signing is not used and to check compatibility of traffic control between adjacent or overlapping projects.

Traffic control planning should be completed for all highway construction, utility work, maintenance operations, and incident management including minor maintenance and utility projects prior to occupying the temporary traffic control zone. Planning for all road users should be included in the process.

Provisions for effective continuity of accessible circulation paths for pedestrians should be incorporated into the temporary traffic control process. Where existing pedestrian routes are blocked or detoured, information should be provided about alternative routes that are usable by pedestrians with disabilities, particularly those who

have visual disabilities. Access to temporary bus stops, safe travel across intersections with accessible pedestrian signals, and other routing issues should be considered where temporary pedestrian routes are channelized. Barriers and channelizing devices that are detectable by people with visual disabilities should be provided.

Option:

Provisions may be incorporated into the project bid documents that enable contractors to develop an alternate temporary traffic control plan.

Modifications of temporary traffic control plans may be necessary because of changed conditions or a determination of better methods of safely and efficiently handling road users.

Guidance:

This alternate or modified plan should have the approval of the West Virginia Division of Highways prior to implementation.

Provisions for effective continuity of transit service should be incorporated into the temporary traffic control planning process because often public transit buses cannot efficiently be detoured in the same manner as other vehicles (particularly for short-term maintenance projects). Where applicable, the temporary traffic control plan should provide for features such as temporary bus stops, pull-outs, and satisfactory waiting areas for transit patrons, including persons with disabilities if applicable (see Section 10A.05 of the "Manual on Uniform Traffic Control Devices" for additional light rail transit issues to consider for temporary traffic control).

Provisions for effective continuity of railroad service and acceptable access to abutting property owners and businesses should also be incorporated into the temporary traffic control planning process.

Reduced speed limits should be used only in the specific portion of the temporary traffic control zone where conditions or restrictive features are present. However, frequent changes in the speed limit should be avoided. A temporary traffic control plan should be designed so that vehicles can safely travel through the temporary traffic control zone with a speed limit reduction of no more than 10 mph.

A reduction of more than 10 mph in the speed limit should be used only when required by restrictive features in the temporary traffic control zone. Where restrictive features justify a speed reduction of more than 10 mph, additional driver notification should be provided. The speed limit should be stepped down in advance of the location requiring the lowest speed, and additional temporary traffic control warning devices should be used.

Reduced speed zoning (lowering the regulatory speed limit) should be avoided as much as practical because drivers will reduce their speeds only if they clearly perceive a need to do so.

Support:

Research has demonstrated that large reductions in the speed limit, such as a 30 mph reduction, increase speed variance and the potential for crashes. Smaller reductions in the speed limit of up to 10 mph cause smaller changes in speed variance and lessen the potential for increased crashes. A reduction in the regulatory speed limit of only up to 10 mph from the normal speed limit has been shown to be more effective.

Section C.02 Temporary Traffic Control Zones

Support:

A temporary traffic control zone is an area of a highway where road user conditions are changed because of a work zone or an incident through the use of temporary traffic control devices, law enforcement officers, or other authorized personnel.

A work zone is an area of a highway with construction, maintenance, or utility work activities. A work zone is typically marked by signs, channelizing devices, barriers, pavement markings, and/or work vehicles. It extends from the first warning sign or high-intensity rotating, flashing, oscillating or strobe lights on a vehicle to the END ROAD WORK sign or the last temporary traffic control device.

An incident area is an area of a highway where temporary traffic controls are imposed by authorized officials in response to a traffic incident, natural disaster, or special event. It extends from the first warning device (such as a sign, light, or cone) to the last temporary traffic control device or to a point where road users return to the original lane alignment and are clear of the incident.

Section C.03 Components of Temporary Traffic Control Zones

Support:

Most temporary traffic control zones are divided into four areas: the advance warning area, the transition area, the activity area, and the termination area. Figure 1 illustrates these four areas. These four areas are described in Sections C.04 through C.07.

Section C.04 Advance Warning Area

Support:

The advance warning area is the section of highway where road users are informed about the upcoming work zone or incident area.

Option:

The advance warning area may vary from a single sign or high intensity rotating, flashing oscillating, or strobe lights on a vehicle to a series of signs in advance of the temporary traffic control zone activity area.

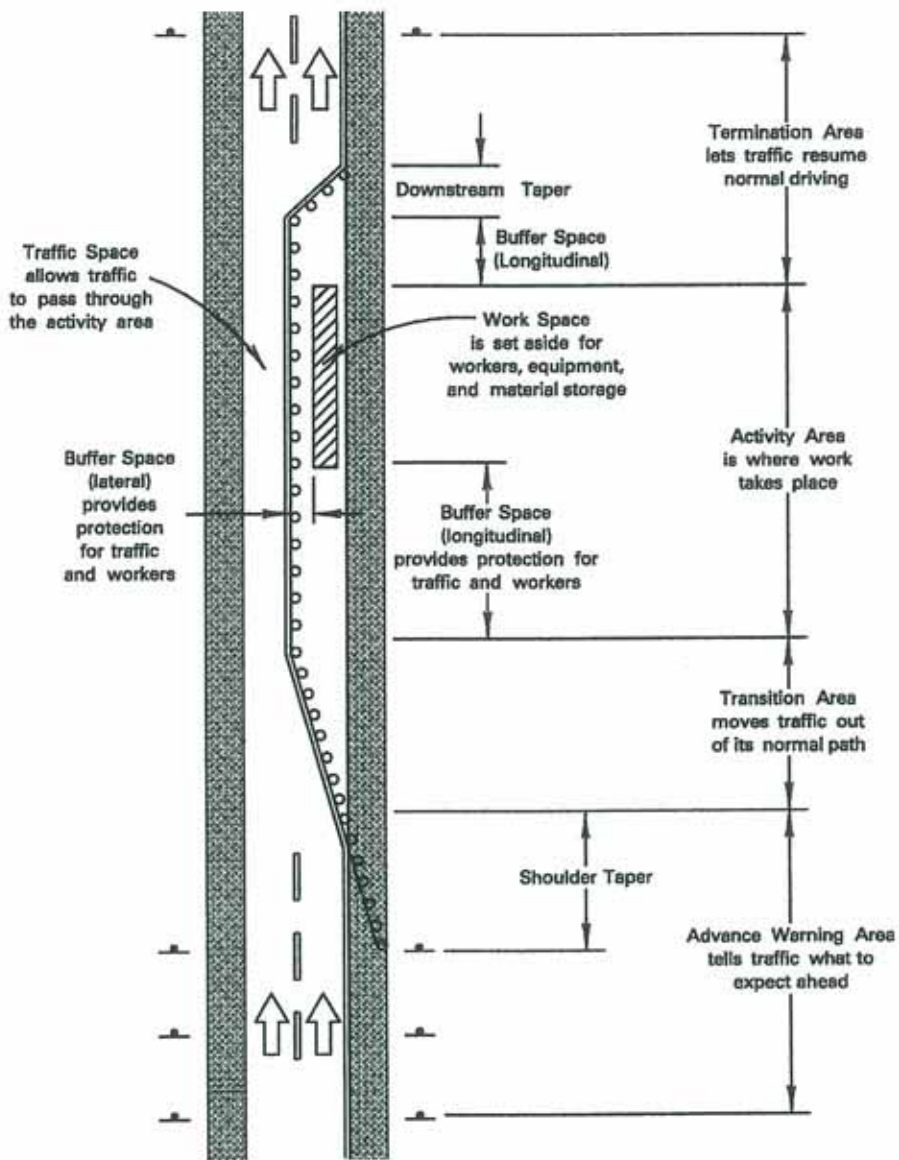

COMPONENT PARTS OF A TEMPORARY TRAFFIC CONTROL ZONE.

FIGURE 1

Guidance:

Typical distances for placement of advance warning signs on expressways and freeways should be longer because drivers are conditioned to uninterrupted flow. Therefore, the advance warning sign placement should extend on these facilities as far as 0.5 mi or more.

Table C-1. Suggested Advance Warning Sign Spacing

ROAD TYPE	DISTANCE BETWEEN SIGNS**		
	A	B	C
Urban (low speed)*	100	100	100
Urban (high speed)*	350	350	350
Rural	500	500	500
Expressway/Freeway	1,000	1,500	2,640

* Speed category to be determined by West Virginia Division of Highways

** Distances are shown in feet. The column headings A, B, and C are the dimensions shown in the Cases. The A dimension is the distance from the transition or point of restriction to the first sign. The B dimension is the distance between the first and second signs. The C dimension is the distance between the second and third signs. (The third sign is the first one in a three-sign series encountered by a driver approaching a temporary traffic control zone.)

On urban streets, the effective placement of the first warning sign in feet should range from 4 to 8 times the speed limit in mph, with the high end of the range being used when speeds are relatively high. When a single advance warning sign is used (in cases such as low-speed residential streets), the advance warning area can be as short as 100 ft. When two or more advance warning signs are used on higher-speed streets, such as major arterials, the advance warning area should extend a greater distance (see Table C-1).

Since rural highways are normally characterized by higher speeds, the effective placement of the first warning sign in feet should be substantially longer—from 8 to 12 times the speed limit in mph. Since two or more advance warning signs are normally used for these conditions, the advance warning area should extend 1,500 ft or more for open highway conditions (see Table C-1).

Option:

Advance warning may be eliminated when the activity area is sufficiently removed from the road users' path so that it does not interfere with the normal flow.

Section C.05 Transition Area

Support:

The transition area is that section of highway where road users are redirected out of their normal path. Transition areas usually involve strategic use of tapers, which because of their importance are discussed separately in detail.

Standard:

When redirection of the road users' normal path is required, they shall be channelized from the normal path to a new path.

Support:

In mobile operations, the transition area moves with the work space.

Section C.06 Activity Area

Support:

The activity area is the section of the highway where the work activity takes place. It is comprised of the work space, the traffic space, and the buffer space.

The work space is that portion of the highway closed to road users and set aside for workers, equipment, and material, and a shadow vehicle if one is used upstream. Work spaces are usually delineated for road users by channelizing devices or, to exclude vehicles and pedestrians, by temporary barriers.

Option:

The work space may be stationary or may move as work progresses.

Guidance:

Since there may be several work spaces (some even separated by several miles) within the project limits, each work space should be adequately signed to inform road users and reduce confusion.

Support:

The traffic space is the portion of the highway in which road users are routed through the activity area.

The buffer space is a lateral and/or longitudinal area that separates road user flow from the work space or an unsafe area, and might provide some recovery space for an errant vehicle.

Guidance:

Neither work activity nor storage of equipment, vehicles, or material should occur within a buffer space.

Option:

Buffer spaces may be positioned either longitudinally or laterally with respect to the direction of road user flow. The activity area may contain one or more lateral or longitudinal buffer spaces.

A longitudinal buffer space may be placed in advance of a work space.

The longitudinal buffer space may also be used to separate opposing road user flows that use portions of the same traffic lane, as shown in Figure 2.

If a longitudinal buffer space is used, the values shown in Table C-2 may be used to determine the length of the longitudinal buffer space.

Support:

Typically, the buffer space is formed as a traffic island and defined by channelizing devices.

When a shadow vehicle, electric arrow, or changeable message sign is placed in a closed lane in advance of work space, only the area upstream of the vehicle, electric arrow, or changeable message sign constitutes the buffer space.

Option:

The lateral buffer space may be used to separate the traffic space from the work space, as shown in Figures 1 and 2, or such areas as excavations or pavement-edge drop-offs. A lateral buffer space also may be used between two travel lanes, especially those carrying opposing flows.

Guidance:

The width of a lateral buffer space should be determined by engineering judgment.

Option:

When work occurs on a high-volume, highly congested facility, a vehicle storage or staging space may be provided for incident response and emergency vehicles (for example, tow trucks and fire apparatus) so that these vehicles can respond quickly to road user incidents.

Guidance:

If used, an incident response and emergency-vehicle storage area should not extend into any portion of the buffer space.

Section C.07 Termination Area

Standard:

The termination area shall be used to return road users to their normal path. The termination area shall extend from the downstream end of the work area to the last temporary traffic control device such as END ROAD WORK signs, if posted.

Option:

An END ROAD WORK sign, a Speed Limit sign, or other signs may be used to inform road users that they can resume normal operations.

A longitudinal buffer space may be used between the workspace and the beginning of the downstream taper.

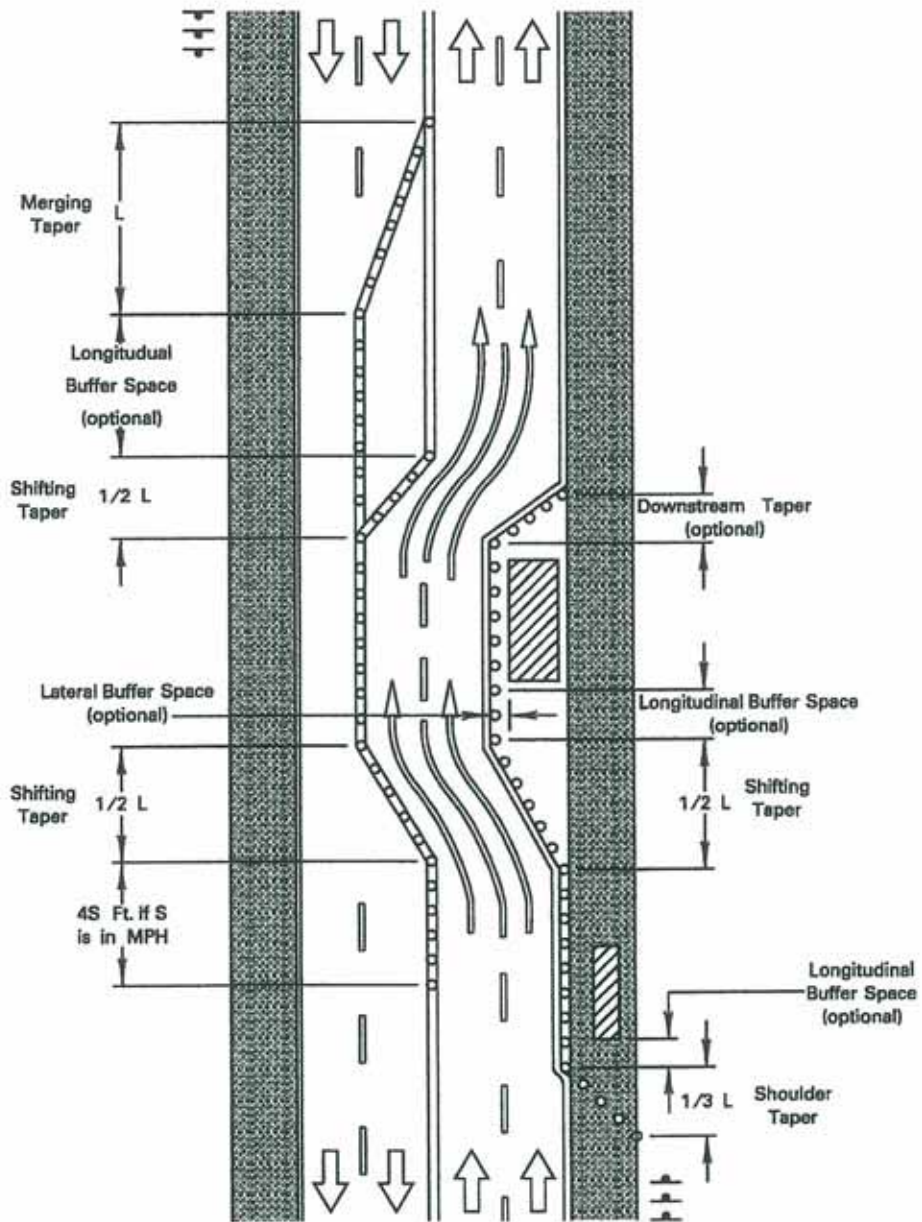

TYPES OF TAPERS AND BUFFER SPACE.
FIGURE 2

Table C-2. Stopping Sight Distance as a Function of Speed

Speed* (mph)	Distance (ft)
20	115
25	155
30	200
35	250
40	305
45	360
50	425
55	495
60	570
65	645
70	730
75	820

* Posted speed, off-peak 85th-percentile speed prior to work starting, or the anticipated operating speed

Section C.08 Tapers

Option:

Tapers may be used in both the transition and termination areas. Whenever tapers are to be used in close proximity to an interchange ramp, crossroads, curves, or other influencing factors, the length of the tapers may be adjusted.

Support:

Tapers are created by using a series of channelizing devices and/or pavement markings to move traffic out of or into the normal path. Types of tapers are shown in Figure 2.

Longer tapers are not necessarily better than shorter tapers (particularly in urban areas with characteristics such as short block lengths, driveways) because extended tapers tend to encourage sluggish operation and to encourage drivers to delay lane changes unnecessarily. The test concerning adequate lengths of tapers involves observation of driver performance after temporary traffic control plans are put into effect.

Guidance:

The appropriate taper length (L) should be determined using criteria shown in Tables C-3 and C-4.

The maximum distance in feet between devices in a taper should not exceed 1.0 times the speed limit in mph.

Support:

A merging taper requires the longest distance because drivers are required to merge into common road space.

Guidance:

A merging taper should be long enough to enable merging drivers to have adequate advance warning and sufficient length to adjust their speeds and merge into a single lane before the end of the transition.

Support:

A shifting taper is used when a lateral shift is needed. When more space is available, a longer than minimum taper distance can be beneficial. Changes in alignment can also be accomplished by using horizontal curves designed for normal highway speeds.

Guidance:

A shifting taper should have a length of approximately 0.5 L (see Tables C-3 and C-4).

Table C-3. Taper Length Criteria for Temporary Traffic Control Zones

Type of Taper	Taper Length (L)*
Merging Taper	at least L
Shifting Taper	at least 0.5L
Shoulder Taper	At least 0.33L
One-Lane, Two-Way Traffic Taper	100 ft maximum
Downstream Taper	100 ft per lane

Table C-4. Formulas for Determining Taper Lengths

Speed Limit (S)	Taper Length (L) Feet
40 mph or less	$L = \frac{WS^2}{60}$
45 mph or more	$L = WS$

Where: L = taper length in feet
 W = width of offset in feet
 S = posted speed limit, or off-peak
 85th-percentile speed prior to work starting,
 or the anticipated operating speed in mph

Support:

A shoulder taper may be beneficial on a high-speed roadway where shoulders are part of the activity area and are closed, or when improved shoulders might be mistaken as a driving lane. In these instances, the same type, but abbreviated, closure procedures used on a normal portion of the roadway can be used.

Guidance:

If used, shoulder tapers should have a length of approximately $0.33 L$ (See Tables C-3 and C-4). If a shoulder is used as a travel lane, either through practice or during a temporary traffic control activity, a normal merging or shifting taper should be used.

Option:

A downstream taper may be useful in termination areas to provide a visual cue to the driver that access is available back into the original lane or path that was closed.

Guidance:

When used, a downstream taper should have a minimum length of approximately 100 ft. per lane with devices placed at a spacing of approximately 20 ft.

Support:

The one-lane, two-way taper is used in advance of an activity area that occupies part of a two-way roadway in such a way that a portion of the road is used alternately by traffic in each direction.

Guidance:

Traffic should be controlled by a flagger or temporary traffic signal (if sight distance is limited), or a STOP or YIELD sign. A short taper having a maximum length of 100 ft with channelizing devices at approximately 20 ft. spacing should be used to guide traffic into the one-way section.

Support:

An example of a one-lane, two-way traffic taper is shown in Figure 3.

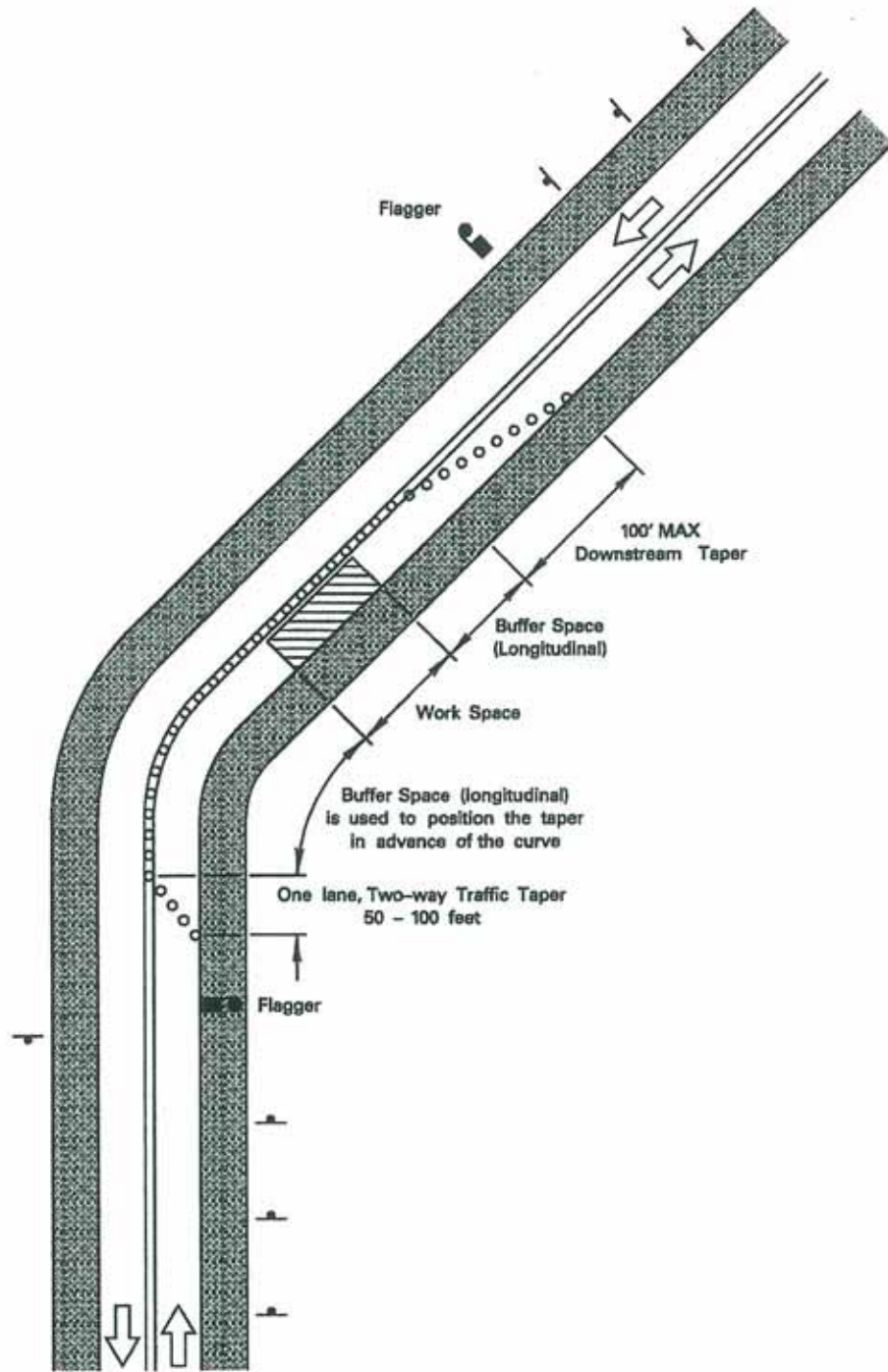

EXAMPLE OF A ONE LANE, TWO-WAY TRAFFIC TAPER.
 FIGURE 3

Section C.09 Detours and Diversions

Support:

A detour is a temporary rerouting of road users onto an existing highway in order to avoid a temporary traffic control zone.

Guidance:

Detours should be clearly signed over their entire length so that road users can easily use existing highways to return to the original highway.

Support:

A diversion is a temporary rerouting of road users onto a temporary highway or alignment placed around the work area.

Section C.10 One-Lane, Two-Way Traffic Control

Standard:

When traffic in both directions must use a single lane for a limited distance, movements from each end shall be coordinated.

Guidance:

Provisions should be made for alternate one-way movement through the constricted section via methods such as flagger control, a flag transfer, a pilot car, traffic control signals, or stop or yield control.

Control points at each end should be chosen to permit easy passing of opposing lanes of vehicles.

If traffic on the affected one-lane roadway is not visible from one end to the other, then flagging procedures, a pilot car, or a traffic control signal should be used to control opposing traffic flows.

Support:

At a spot constriction, such as an isolated pavement patch on highways with lower speeds and adequate sight distance, the movement of traffic through one-lane, two-way constrictions tends to be self-regulating.

Section C.11 Flagger Method of One-Lane, Two-Way Traffic Control

Option:

When a one-lane, two-way temporary traffic control zone is short enough to allow a flagger to see from one end of the zone to the other, traffic may be controlled by either a single flagger or by a flagger at each end of the section.

Guidance:

When a single flagger is used, the flagger should be stationed on the shoulder opposite the constriction or work space, or in a position where good visibility and traffic control can be maintained at all times. When good visibility and traffic control cannot be maintained by one flagger station, traffic should be controlled by a flagger at each end of the section. One of the flaggers should be designated as the coordinator. Flaggers should be able to communicate with each other orally, electronically, or with manual signals. These manual signals should not be mistaken for flagging signals.

Section C.12 Flag Transfer Method of One-Lane, Two-Way Traffic Control

Support:

The driver of the last vehicle proceeding into the one-lane section is given a red flag (or other token) and instructed to deliver it to the flagger at the other end. The opposite flagger, upon receipt of the flag, then knows that it is safe to allow traffic to move in the other direction. A variation of this method is to replace the use of a flag with an official pilot car that always follows the last road user vehicle proceeding through the section.

Guidance:

The flag transfer method should be employed only where the one-way traffic is confined to a relatively short length of a road, usually not more than 1 mi in length.

Section C.13 Pilot Vehicle Method of One-Lane, Two-Way Traffic Control

Option:

A pilot vehicle may be used to guide a queue of vehicles through the temporary traffic control zone or detour.

Guidance:

The operation of the pilot vehicle should be coordinated with flagging operations or other controls at each end of the one-lane section.

Standard:

The PILOT VEHICLE FOLLOW ME (G20-4) sign shall be mounted at a conspicuous location on the rear of the vehicle.

Section C.14 Temporary Traffic Control Signal Method of One-Lane, Two-Way Traffic Control

Option:

Traffic control signals may be used to control vehicular traffic movements in one-lane, two-way temporary traffic control zones (see Cases D5A and D5B and Chapter 4G of the "Manual on Uniform Traffic Control Devices").

Section C.15 Stop or Yield Control Method of One-Lane, Two-Way Traffic Control

Option:

STOP or YIELD signs may be used to control traffic on low-volume roads at a one-lane, two-way temporary traffic control zone when drivers are able to see the other end of the one-lane, two-way operation and have sufficient visibility of approaching vehicles.

Guidance:

If the STOP or YIELD sign is installed for only one direction, then the STOP or YIELD sign should face road users who are driving on the side of the roadway that is closed for the work activity area.

CHAPTER D. PEDESTRIAN AND WORKER SAFETY

Section D.01 Pedestrian Considerations

Standard:

The needs and control of all road users (motorists, bicyclists, and pedestrians within the highway, including persons with disabilities in accordance with the Americans with Disabilities Act of 1990 (ADA), Title II, Paragraph 35.130) through a temporary traffic control zone shall be an essential part of highway construction, utility work, maintenance operations, and the management of traffic incidents.

Support:

A wide range of pedestrians might be affected by Temporary Traffic Control zones, including the young, elderly, and people with disabilities such as hearing, visual, or mobility. These pedestrians need a clearly delineated and usable travel path. Considerations for pedestrians with disabilities are addressed in Section D.02.

The most desirable way to provide information to pedestrians with visual disabilities that is equivalent to visual signage for notification of sidewalk closures is a speech message provided by the audible information device. Devices that provide speech messages in response to passive pedestrian actuation are the most desirable. Other devices that continuously emit a message, or that emit a message in response to use of a pushbutton, are also acceptable. Signage information can also be transmitted to personal receivers, but currently such receivers are not likely to be carried or used by pedestrians with visual disabilities in temporary traffic control zones. Audible information devices might not be needed if detectable channelizing devices make an alternate route of travel evident to pedestrians with visual disabilities.

Guidance:

If a pushbutton is used to provide equivalent temporary traffic control information to pedestrians with visual disabilities, the pushbutton should be equipped with a locator tone to notify pedestrians with visual disabilities that a special accommodation is available, and to help them locate the pushbutton.

Standard:

The various temporary traffic control provisions for pedestrian and worker safety set forth in this manual shall be applied by knowledgeable (for example, trained and/or certified) persons after appropriate evaluation and engineering judgment.

Advance notification of sidewalk closures shall be provided to the maintaining agency. Where pedestrians with visual disabilities normally use the closed sidewalk, a barrier that is detectable by a person with a visual disability traveling with the aid of a long cane shall be placed across the full width of the closed sidewalk.

Support:

It must be recognized that pedestrians are reluctant to retrace their steps to a prior intersection for a crossing or to add distance or out-of-the way travel to a destination.

Guidance:

Adequate provisions should be made for persons with disabilities as determined by an engineering study or by engineering judgment. Because printed signs and surface delineation are not usable by pedestrians with visual disabilities, blocked routes, alternate crossings, and sign and signal information should be communicated to pedestrians with visual disabilities by providing audible information devices, accessible pedestrian signals, and barriers and channelizing devices that are detectable to pedestrians traveling with the aid of a long cane or who have low vision.

The following three items should be considered when planning for pedestrians in temporary traffic control zones:

- A. Pedestrians should not be led into conflicts with work site vehicles, equipment, and operations.
- B. Pedestrians should not be led into conflicts with vehicles moving through or around the work site.
- C. Pedestrians should be provided with a reasonably safe, convenient, and accessible path that replicates as nearly as practical the most desirable characteristics of the existing sidewalk(s) or footpath(s). Where pedestrians who have visual disabilities encounter work sites that require them to cross the roadway to find an accessible route, audible instructions should be provided using an audible information device. Accessible pedestrian signals with accessible pedestrian detectors might be needed to enable pedestrians with visual disabilities to cross wide or heavily traveled roadways.

A pedestrian route should not be severed and/or moved for nonconstruction activities such as parking for vehicles and equipment.

Consideration should be made to separate pedestrian movements from both work site activity and vehicular traffic. Unless a reasonably safe route that does not involve crossing the roadway can be provided, pedestrians should be appropriately directed with advance signing that encourages them to cross to the opposite side of the roadway. In urban and suburban areas with high vehicular traffic volumes, these signs should be placed at intersections (rather than midblock locations) so that pedestrians are not confronted with midblock work sites that will induce them to attempt skirting the work site or making a midblock crossing.

Support:

Cases B3A and B3B show typical temporary traffic control device usage and techniques for pedestrian movement through work zones.

Guidance:

When pedestrian movement through or around a work site is necessary, a separate usable footpath should be provided. If the previous pedestrian facility was accessible to pedestrians with disabilities, the footpath provided during temporary traffic control should also be accessible. There should not be any abrupt changes in grade or terrain that could cause a tripping hazard or could be a barrier to wheelchair use. Barriers and channelizing devices should be detectable to pedestrians who have visual disabilities.

Option:

Whenever it is feasible, closing off the work site from pedestrian intrusion may be preferable to channelizing pedestrian traffic along the site with temporary traffic control devices.

Support:

Maintaining a detectable, channelized pedestrian route is much more useful to pedestrians who have visual disabilities than closing a walkway and providing audible directions to an alternate route involving additional crossings and a return to the original route. Braille is not useful in conveying such information because it is difficult to find. Audible instructions might be provided, but the extra distance and additional street crossings might add complexity to a trip.

Guidance:

Fencing should not create sight distance restrictions for road users. Fences should not be constructed of materials that would be hazardous if impacted by vehicles.

Wooden railing, fencing, and similar systems placed immediately adjacent to motor vehicle traffic should not be used as substitutes for crashworthy temporary traffic barriers.

Standard:

Temporary traffic control devices used to delineate a temporary traffic control zone pedestrian walkway shall be crashworthy and, when struck by vehicles, present a minimum threat to pedestrians, workers, and occupants of impacting vehicles.

Guidance:

Ballast for temporary traffic control devices should be kept to the minimum amount needed and should be mounted low to prevent penetration of the vehicle windshield.

Movement by work vehicles and equipment across designated pedestrian paths should be minimized and, when necessary, should be controlled by flaggers or temporary traffic control. Staging or stopping of work vehicles or equipment along the side of pedestrian paths should be avoided, since it encourages movement of workers, equipment, and materials across the pedestrian path.

Access to work space by workers and equipment across pedestrian walkways should be minimized because the access often creates unacceptable changes in grade, and rough or muddy terrain, and pedestrians will tend to avoid these areas by attempting nonintersection crossings where no curb ramps are available.

Option:

A canopied walkway may be used to protect pedestrians from falling debris, and to provide a covered passage for pedestrians.

Guidance:

Covered walkways should be sturdily constructed and adequately lighted for nighttime use.

When pedestrian and vehicle paths are rerouted to a closer proximity to each other, consideration should be given to separating them by a temporary traffic barrier.

If a temporary traffic barrier is used to shield pedestrians, it should be designed to suit site conditions.

Support:

Depending on the possible vehicular speed and angle of impact, temporary traffic barriers might deflect upon impact by an errant vehicle. Guidance for locating and designing temporary traffic barriers can be found in Chapter 9 of AASHTO's "Roadside Design Guide" (see Section 1A.11).

Standard:

Short intermittent segments of temporary traffic barrier shall not be used because they nullify the containment and redirective capabilities of the temporary traffic barrier, increase the potential for serious injury both to vehicle occupants and pedestrians, and encourage the presence of blunt, leading ends. All upstream leading ends that are present shall be appropriately flared or protected with properly installed and maintained crashworthy cushions. Adjacent temporary traffic barrier segments shall be properly connected in order to provide the overall strength required for the temporary traffic barrier to perform properly.

Normal vertical curbing shall not be used as a substitute for temporary traffic barriers when temporary traffic barriers are clearly needed.

Option:

Temporary traffic barriers or longitudinal channelizing devices may be used to discourage pedestrians from unauthorized movements into the work space. They may also be used to inhibit conflicts with vehicular traffic by minimizing the possibility of midblock crossings.

Support:

A major concern for pedestrians is urban and suburban building construction encroaching onto the contiguous sidewalks, which forces pedestrians off the curb into direct conflict with moving vehicles.

Guidance:

If a significant potential exists for vehicle incursions into the pedestrian path, pedestrians should be rerouted or temporary traffic barriers should be installed.

Support:

Temporary traffic control devices, jersey barriers, and wood or chainlink fencing with a continuous detectable edging can satisfactorily delineate a pedestrian path.

Guidance:

Tape, rope, or plastic chain strung between devices are not detectable, do not comply with the design standards in the "Americans with Disabilities Act Accessibility Guidelines" (see Section 1A.11 of the "Manual on Uniform Traffic Control Devices"), and should not be used as a control for pedestrian movements.

The extent of pedestrian needs should be determined through engineering judgment for each temporary traffic control situation. In general, pedestrian routes should be preserved in urban and commercial suburban areas. Alternate routing should be discouraged.

The highway agency in charge of the temporary traffic control zone should regularly inspect the activity area so that effective pedestrian temporary traffic control is maintained.

Section D.02 Accessibility Considerations

Guidance:

The extent of pedestrian needs should be determined through engineering judgment or by the individual responsible for each Temporary Traffic Control zone situation. This individual should be aware that the absence of a continuous pathway, including curb ramps and other accessible features, might preclude the use of the facility by pedestrians with disabilities.

Standard:

When existing pedestrian facilities are disrupted, closed, or relocated in a Temporary Traffic Control zone, the temporary facilities shall be detectable and include accessibility features consistent with the features present in the existing pedestrian facility.

Guidance:

To accommodate the needs of pedestrians, including those with disabilities, the following considerations should be addressed when temporary pedestrian pathways in Temporary Traffic Control zones are designed or modified.

- A. Provisions for continuity of accessible paths for pedestrians should be incorporated into the Temporary Traffic Control process. Pedestrians should be provided with a reasonably safe, convenient, and accessible path that replicates as much as practical the desirable characteristics of the existing pedestrian facilities.
- B. Access to temporary transit stops should be provided.
- C. Blocked routes, alternate crossings, and sign and information should be communicated to pedestrians with visual disabilities by providing devices such as audible information devices, accessible pedestrian signals, or barriers and channelizing devices that are detectable to the pedestrians traveling with the aid of a long cane or who have low vision. Where pedestrian traffic is detoured to a Temporary Traffic Control signal, engineering judgment should be used to determine if pedestrian signals or accessible pedestrian signals should be considered for crossings along an alternate route.
- D. When channelization is used to delineate a pedestrian pathway, a continuous detectable edging should be provided throughout the length of the facility such that pedestrians using a long cane can follow it. These detectable edgings should adhere to the provisions of Section F.68.
- E. A smooth, continuous hard surface should be provided throughout the entire length of the temporary pedestrian facility. There should be no curbs or abrupt changes in grade or terrain that could cause tripping or be a barrier to wheelchair use. The geometry and alignment of the facility should meet the applicable requirements of the "Americans with Disabilities Act Accessibility Guidelines for Buildings and Facilities (ADAAG)" (see Section 1A.11 of the "Manual on Uniform Traffic Control Devices."
- F. The width of the existing pedestrian facility should be provided for the temporary facility if practical. Traffic control devices and other construction materials and features should not intrude into the usable width of the sidewalk, temporary pathway, or other pedestrian facility. When it is not possible to maintain a minimum width of 60 inches throughout the entire length of the pedestrian pathway, a 60 x 60 inches passing space should be provided at least every 200 feet, to allow individuals in wheelchairs to pass.
- G. Signs and other devices mounted lower than 7 feet above the temporary pedestrian pathway should not project more than 4 inches into accessible facilities.

Section D.03 Worker Safety Considerations

Support:

Equally as important as the safety of road users traveling through the temporary traffic control zone is the safety of workers. Temporary traffic control zones present temporary and constantly changing conditions that are unexpected by the road user. This creates an even higher degree of vulnerability for workers on or near the roadway.

Maintaining temporary traffic control zones with road user flow inhibited as little as possible, and using temporary traffic control devices that get the road user's attention and provide positive direction are of particular importance. Likewise, equipment and vehicles moving within the activity area create a risk to workers on foot. When possible, the separation of moving equipment and construction vehicles from workers on foot provides the operator of these vehicles with a greater separation clearance and improved sight lines minimizing some of the hazards inherent in the activity area.

Guidance:

The following are the key elements of worker safety and temporary traffic control management that should be considered to improve worker safety:

- A. Training—all workers should be trained on how to work next to motor vehicle traffic in a way that minimizes their vulnerability. Workers having specific temporary traffic control responsibilities should be trained in temporary traffic control techniques, device usage, and placement.
- B. Worker Safety Apparel —all workers exposed to the risks of moving roadway traffic or construction equipment should wear high visibility safety apparel meeting the requirements of ISEA “American National Standard for High-Visibility Safety Apparel” (see Section 1A.11 of the “Manual on Uniform Traffic Control Devices”) and labeled as ANSI 107-1999 standard performance for Class 1, 2, or 3 risk exposure. A competent person designated by the employer to be responsible for the worker safety plan within the activity area of the job site should make the selection of the appropriate class of garment.
- C. Temporary Traffic Barriers—temporary traffic barriers should be placed along the work space depending on factors such as lateral clearance of workers from adjacent traffic, speed of traffic, duration and type of operations, time of day, and volume of traffic.
- D. Speed Reduction—reducing the speed of vehicular traffic, mainly through regulatory speed zoning, funneling, use of uniformed law enforcement officials or flaggers should be considered.
- E. Activity Area—planning the internal work activity area to minimize backing-up maneuvers of construction vehicles should be considered to minimize the exposure to risk.

- F. Worker Safety Planning—a competent person designated by the employer should conduct a basic hazard assessment for the work site and job classifications required in the activity area. This safety professional should determine whether engineering, administrative, or personal protection measures should be implemented. This plan should be in accordance with the Occupational Safety and Health Act “General Duty Clause” Section 5(a)(1) – Public Law 91-596, 84 Stat. 1590, December 29, 1970, as amended, and with the requirement to assess worker risk exposures for each job site and job classification, as per 1926.20(b)(2) of “Occupational Safety and Health Administration Regulations (Standards – 29 CFR), General Safety and Health Provisions – 1926.20.” (see Section 1A.11 of the “Manual on Uniform Traffic Control Devices”).

Option:

The following are additional elements of temporary traffic control management that may be considered to improve worker safety:

- A. Shadow Vehicle—in the case of mobile and constantly moving operations, such as pothole patching and striping operations, a shadow vehicle, equipped with appropriate lights and warning signs, may be used to protect the workers from impacts by errant vehicles. The shadow vehicle may be equipped with a rear-mounted impact attenuator.
- B. Road Closure—if alternate routes are available to handle road users, the road may be closed temporarily. This may also facilitate project completion and thus further reduce worker vulnerability.
- C. Law Enforcement—in highly vulnerable work situations, particularly those of relatively short duration, law enforcement units may be stationed to heighten the awareness of passing vehicular traffic and to improve safety through the temporary traffic control zone.
- D. Lighting—for nighttime work, the temporary traffic control zone and approaches may be lighted.
- E. Special Devices—these include rumble strips, changeable message signs, hazard identification beacons, flags, and warning lights. Intrusion warning devices might be used to alert workers to the approach of errant vehicle.

Support:

Judicious use of the special devices described in Item E above might be helpful for certain difficult temporary traffic control situations, but misuse or overuse of special devices or techniques might lessen their effectiveness.

CHAPTER E. FLAGGER CONTROL

Section E.01 Qualifications for Flaggers

Standard:

A flagger shall be a person who provides temporary traffic control.

Guidance:

Because flaggers are responsible for public safety and make the greatest number of contacts with the public of all highway workers, they should be trained in safe traffic control practices and public contact techniques. Flaggers should be able to satisfactorily demonstrate the following skills and abilities:

- A. Ability to receive and communicate specific instructions clearly, firmly, and courteously;
- B. Ability to move and maneuver quickly in order to avoid danger from errant vehicles;
- C. Ability to control signaling devices (such as paddles and flags) in order to provide clear and positive guidance to drivers approaching a temporary traffic control zone in frequently changing situations;
- D. Ability to understand and apply safe traffic control practices, sometimes in stressful or emergency situations; and
- E. Ability to recognize dangerous traffic situations and warn workers in sufficient time to avoid injury.

Section E.02 High-Visibility Clothing

Standard:

For daytime and nighttime activity, flaggers shall wear safety apparel meeting the requirements of ISEA "American National Standard for High-Visibility Apparel" and labeled as meeting the ANSI 107-1999 standard performance for Class 2 risk exposure. The apparel background (outer) material shall be either fluorescent orange or fluorescent yellow-green as defined in the standard. The retroreflective material shall be either orange, yellow, white, silver, yellow-green, or a fluorescent version of these colors, and shall be visible at a minimum distance of 1,000 ft. The retroreflective safety apparel shall be designed to clearly identify the wearer as a person.

Guidance:

For nighttime activity, safety apparel meeting the requirements of ISEA "American National Standard for High Visibility Apparel" and labeled as meeting the ANSI 107-1999 Standard Performance for Class 3 risk exposure should be considered for flagger wear (instead of Class 2 Safety Apparel in the Standard above).

When uniformed law enforcement officers are used, high-visibility safety apparel as described in this section should be worn by the law enforcement officer.

Section E.03 Hand-Signaling Devices

Support:

Hand-signaling devices, such as STOP/SLOW paddles, lights, and red flags, are used to control road users through temporary traffic control zones.

Guidance:

The STOP/SLOW paddle should be the primary and preferred hand-signaling device because the STOP/SLOW paddle gives road users more positive guidance than red flags. Use of flags should be limited to emergency situations.

Standard:

The STOP/SLOW paddle shall have an octagonal shape on a rigid handle. STOP/SLOW paddles shall be at least 18 in wide with letters at least 6 in. high and should be fabricated from light semirigid material. The background of the STOP face shall be red with white letters and border. The background of the SLOW face shall be orange with black letters and border. When used at night, the STOP/SLOW paddle shall be retroreflectorized.

Option:

The STOP/SLOW paddle may be modified to improve conspicuity by incorporating white or red flashing lights on the STOP face, and either white or yellow flashing lights on the SLOW face. The white flashing lights may be arranged in any of the following patterns:

- A. Two white or red lights one centered vertically above and one centered vertically below the STOP legend; and/or two white or yellow lights, one centered vertically above and one centered vertically below the SLOW legend; or
- B. Two white or red lights one centered horizontally on each side of the STOP legend; and/or two white or yellow lights, one centered horizontally on each side of the SLOW legend; or
- C. One white light or red light centered below the STOP legend; and/or one white or yellow light centered below the SLOW legend; or

- D. A series of eight or more small white or red lights no larger than 1/4 in. in diameter along the outer edge of the paddle, arranged in an octagonal pattern at the eight corners of the border of the STOP face; and/or a series of eight or more small white or yellow lights no longer than 1/4 in. in diameter along the outer edge of the paddle, arranged in a diamond pattern along the border or the SLOW face.
- E. A series of white lights forming the shape of the letters in the legend.

Standard:

If flashing lights are used on the STOP face of the paddle, their colors shall be all white or all red. If flashing lights are used on the SLOW face of the paddle, their colors shall be all white or all yellow.

If more than eight flashing lights are used, the lights shall be arranged such that they clearly convey the octagonal shape of the STOP face of the paddle and/or the diamond shape of the SLOW face of the paddle.

If flashing lights are used on the STOP/SLOW paddle, the flash rate shall be at least 50, but not more than 60, flashes per minute.

Flags, when used, shall be a minimum of 24 in. square, made of a good grade red material and securely fastened to a staff that is approximately 36 in. in length.

Guidance:

The free edge of a flag should be weighted so the flag will hang vertically, even in heavy winds.

Standard:

When used at nighttime, flags shall be retroreflectorized red.

Section E.04 Flagger Procedures

Support:

The use of paddles and flags by flaggers are illustrated in Figure 4.

Standard:

The following methods of signaling with paddles shall be used:

- A. To stop road users, the flagger shall face road users and aim the STOP paddle face toward road users in a stationary position with the arm extended horizontally away from the body. The free arm shall be held with the palm of the hand above shoulder level toward approaching traffic.

- B. To direct stopped road users to proceed, the flagger shall face road users with the SLOW paddle face aimed toward road users in a stationary position with the arm extended horizontally away from the body. The flagger shall motion with the free hand for road users to proceed.
- C. To alert or slow traffic, the flagger shall face road users with the SLOW paddle face aimed toward road users in a stationary position with the arm extended horizontally away from the body.

Option:

To further alert or slow traffic, the flagger holding the SLOW paddle face toward road users may motion up and down with the free hand, palm down.

Standard:

The following methods of signaling with a flag shall be used:

- A. To stop road users, the flagger shall face road users and extend the flag staff horizontally across the road users' lane in a stationary position so that the full area of the flag is visibly hanging below the staff. The free arm shall be held with the palm of the hand above the shoulder level toward approaching traffic.
- B. To direct stopped road users to proceed, the flagger shall stand parallel to the road user movement and with flag and arm lowered from the view of the road users, and shall motion with the free hand for road users to proceed. Flags shall not be used to signal road users to proceed.
- C. To alert or slow traffic, the flagger shall face road users and slowly wave the flag in a sweeping motion of the extended arm from shoulder level to straight down without raising the arm above a horizontal position. The flagger shall keep the free hand down.

Section E.05 Flagger Stations

Standard:

Flagger stations shall be located such that approaching road users will have sufficient distance to stop at an intended stopping point.

Option:

The distance shown in Table E-1, which provides information regarding the stopping signs distance as a function of speed, may be used for the location of the flagger station. These distances may be increased for downgrades and other conditions that affect stopping distance.

PREFERRED METHOD
STOP/SLOW PADDLE



EMERGENCY SITUATIONS ONLY
RED FLAG

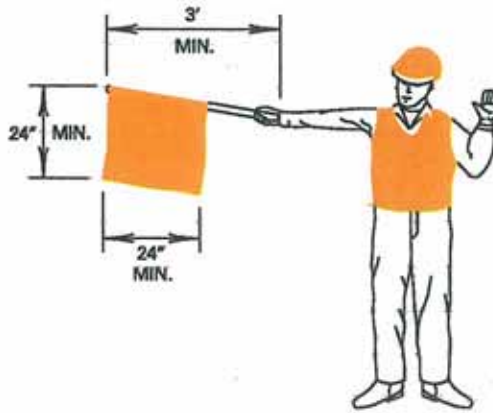

To Stop Traffic



To Let
Traffic Proceed



To Alert and
Slow Traffic

USE OF HAND SIGNALING DEVICES BY FLAGGER.
FIGURE 4

Guidance:

Flagger stations should be located such that an errant vehicle has additional space to stop without entering the work space.

Standard:

Except in emergency situations, flagger stations shall be preceded by an advance warning sign or signs. Except in emergency situations, flagger stations shall be illuminated at night.

Guidance:

The flagger should stand either on the shoulder adjacent to the road user being controlled or in the closed lane prior to stopping road users. A flagger should only stand in the lane being used by moving road users after road users have stopped. The flagger should be clearly visible to the first approaching road user at all times. The flagger also should be visible to other road users. The flagger should be stationed sufficiently in advance of the workers to warn them (for example, with audible warning devices such as horns, and whistles) of approaching danger by out-of-control vehicles. The flagger should stand alone, never permitting a group of workers to congregate around the flagger station.

Option:

At a spot constriction, the flagger may have to take a position on the shoulder opposite the closed section in order to operate effectively.

At spot lane closures where adequate sight distance is available for the safe handling of traffic, the use of one flagger may be sufficient.

Table E-1. Stopping Sight Distance as a Function of Speed

Speed* (mph)	Distance (ft)
20	115
25	155
30	200
35	250
40	305
45	360
50	425
55	495
60	570
65	645
70	730
75	820

* Posted speed, off-peak 85th-percentile speed prior to work starting, or the anticipated operating speed

CHAPTER F. TEMPORARY TRAFFIC CONTROL ZONE DEVICES

Section F.01 Types of Devices

Standard:

The needs and Control of all road users (motorists, bicyclists, and pedestrians within the highway, including persons with disabilities in accordance with the Americans with Disabilities Act of 1990 (ADA), Title II, Paragraph 35.130) through the temporary traffic control zone shall be an essential part of highway construction, utility work, maintenance operations, and the management of traffic incidents.

Guidance:

The design and application of temporary traffic control devices used in temporary traffic control zones should consider the needs of all road users (motorists, bicyclists, and pedestrians), including those with disabilities.

Support:

FHWA policy requires that all roadside appurtenances such as traffic barrier, barrier terminals and crash cushions, bridge railings, sign and light pole supports, and work zone hardware used on the National Highway System meet the crashworthy performance criteria contained in the National Cooperative Highway Research Program (NCHRP) Report 350, "Recommended Procedures for the Safety Performance Evaluation of Highway Features." The FHWA has a website that identifies all such hardware and includes copies of FHWA acceptance letters for each of them. In the case of proprietary items, links are provided to manufacturer's websites as detailed information on specific devices.

Crashworthiness and crash testing information on devices described in this manual are found in the latest version of AASHTO's "Roadside Design Guide" (see Section 1A.11 of "Manual on Uniform Traffic Control Devices"). "Crashworthy" is a characteristic of a roadside appurtenance that has been successfully crash tested in accordance with a national standard such as the National Cooperative Highway Research Program Report 350, "Recommended Procedures for the Safety Performance Evaluation of Highway Features."

Standard:

Traffic control devices shall be defined as all signs, signals, markings, and other devices used to regulate, warn, or guide road users, placed on, over, or adjacent to a street, highway, pedestrian facility, or bikeway by authority of a public body or official having jurisdiction.

All traffic control devices used on street and highway construction, maintenance, utility, or incident management operations shall conform to the applicable provisions of this Manual.

Section F.02 General Characteristics of Signs

Support:

Temporary traffic control zone signs convey both general and specific messages by means of words or symbols and have the same three categories as all road user signs: regulatory, warning, and guide.

Standard:

The colors for regulatory signs shall follow the Standards for regulatory signs in Table 2A-4 and Chapter 2B of the "Manual on Uniform Traffic Control Devices." Warning signs in temporary traffic control zones shall have a black legend and border on a fluorescent orange background, except for Highway-Rail Grade Crossing Advance Warning (W10-1) sign which shall have a black legend and border on a yellow background, and except for signs that are permitted in Parts 2 or 7 of the above mentioned manual to have fluorescent yellow-green backgrounds. Colors for guide signs shall follow the Standards in Table 2A-4 and Chapter 2D, of the above mentioned Manual except for guide signs as noted in Section F.50.

Support:

The fluorescent versions of orange provide higher conspicuity than standard orange, especially during twilight.

Option:

Existing warning signs that are still applicable may remain in place.

In order to maintain the systematic use of yellow or fluorescent yellow-green background for pedestrian, bicycle, and school warning signs in a jurisdiction, the yellow or fluorescent yellow-green background for pedestrian, bicycle, and school warning signs may be used in temporary traffic control zones.

Standard orange flags or flashing warning lights may be used in conjunction with signs.

Standard:

When standard orange flags or flashing warning lights are used in conjunction with signs, they shall not block the sign face.

Option:

The dimensions of signs shown in this manual are for standard sizes, which may be increased wherever necessary for greater legibility or emphasis, such as on freeways and expressways.

Standard:

Deviations from standard sizes as prescribed herein shall be in 6 in. increments.

Support:

Sign design details are contained in the West Virginia Division of Highways "Sign Fabrication Details" book.

Standard:

All signs used at night shall be either retroreflective with a material that has a smooth, sealed outer surface or illuminated to show the same shape and similar color both day and night.

The requirement for sign illumination shall not be considered to be satisfied by street, highway, or strobe lighting.

Option:

Sign illumination may be either internal or external.

Sign maybe made of rigid or flexible material.

Section F.03 Sign Placement

Guidance:

Signs should be located on the right side of the roadway unless otherwise specified in this Manual.

Option:

Where special emphasis is needed, signs may be placed on both the left and right sides of the roadway. Signs mounted on portable supports may be placed within the roadway itself. Signs may also be mounted on or above barricades.

Support:

Guidelines for height and lateral clearance of temporary post-mounted signs are shown in Detail "B".

Standard:

Ground-mounted signs installed at the side of the road in rural areas shall be mounted at a height at least 6 ft., measured from the bottom of the sign to the near edge of the pavement. In business, commercial, and residential districts where parking and/or bicycle or pedestrian movement is likely to occur, or where there are other obstructions to view, the distance between the bottom of the sign and the top of the near edge of the traveled way shall be at least 7 ft.

Signs mounted on barricades and barricade/sign combinations shall be crashworthy.

Where it has been determined that the accommodation of pedestrians with disabilities is necessary, signs shall be mounted and placed in accordance with Section 4.4 of the "Americans With Disabilities Act Accessibility Guidelines for Buildings and Facilities (ADAAG)."

Guidance:

Neither portable nor permanent sign supports should be located on sidewalks, bicycle facilities, or areas designated for pedestrian or bicycle traffic. Signs mounted lower than 7 ft. should not project more than 4 inches into pedestrian facilities.

Option:

A 7 ft. mounting height may be used in rural areas for increased visibility.

The height to the bottom of a secondary sign mounted below another sign may be 1 ft. less than the appropriate height specified above.

Guidance:

Except as noted in the Option, signs mounted on portable supports should not be used for a duration of more than 3 days.

Option:

The R9-9 through R9-11A series, R11 series, W1-6 through W1-8 series, M4-10, E5-1, or other similar type signs may be used on portable supports for longer than 3 days.

Support:

Methods of mounting signs other than on posts are illustrated in Figure 9-Detail "B".

Guidance:

Signs mounted on Type III barricades should not cover more than 50 percent of the top two rails or 33 percent of the total area of the three rails.

Standard:

Sign supports shall be crashworthy. Large signs having an area exceeding 50 square feet that are installed on multiple breakaway posts shall be mounted a minimum of 7 ft. above the ground.

Signs mounted on barricades, or other portable supports, shall be no less than 1 ft. above the traveled way.

Option:

For mobile operations, a sign may be mounted on a work vehicle, a shadow vehicle, or a trailer stationed in advance of the temporary traffic control zone or moving along with it. The work vehicle, the shadow vehicle, or the trailer may or may not have an impact attenuator.

Guidance:

Unshielded sign posts placed in the clear zone should yield or breakaway on impact to minimize obstructions to road users.

If alterations are made to specific traffic control device supports that have been successfully crash tested in accordance with NCHRP Report 350, the altered supports might not be considered to be crashworthy.

Section F.04 Sign Maintenance

Standard:

Signs shall be properly maintained for cleanliness, visibility, and correct positioning.

Signs that have lost significant legibility shall be promptly replaced.

Section F.05 Regulatory Sign Authority

Support:

Regulatory signs inform road users of traffic laws or regulations and indicate the applicability of legal requirements that would not otherwise be apparent (see Figures 5A, 5B, and 5C).

Standard:

Regulatory signs shall be authorized by the public agency or official having jurisdiction and shall conform with Chapter 2B of the “Manual on Uniform Traffic Control Devices.”

Section F.06 Regulatory Sign Design

Standard:

Temporary traffic control regulatory signs shall conform to the Standards for regulatory signs presented in Part 2 of the “Manual on Uniform Traffic Control Devices” and the West Virginia Division of Highways “Sign Fabrication Details”.

Support:

Regulatory signs are generally rectangular with a black legend and border on a white background. Exceptions include the STOP, YIELD, DO NOT ENTER, WRONG WAY, and ONE WAY signs.

Option:

The ONE WAY sign may be either a horizontal or vertical rectangular sign.

Section F.07 Regulatory Sign Applications

Standard:

If a temporary traffic control zone requires regulatory measures different from those existing, the existing permanent regulatory devices shall be removed or covered and superseded by the appropriate temporary regulatory signs. This change shall be made in conformance with applicable ordinances or statutes of the jurisdiction.

Section F.08 ROAD CLOSED Sign (R11-2)

Guidance:

The ROAD CLOSED (R11-2) sign should be used when the roadway is closed to all road users except contractors' equipment or officially authorized vehicles. The R11-2 sign should be accompanied by appropriate warning and detour signing.

Option:

The words BRIDGE CLOSED may be substituted for ROAD CLOSED where applicable.

Guidance:

The ROAD CLOSED sign should be installed at or near the center of the roadway on or above a Type III barricade that closes the roadway (see Section F.63).

Standard:

The ROAD CLOSED sign shall not be used where road user flow is maintained or where the actual closure is some distance beyond the sign.

Section F.09 Local Traffic Only Signs (R11-3A, R11-3B, R11-4)

Guidance:

The Local Traffic Only signs should be used where road user flow detours to avoid a closure some distance beyond the sign, but where local road users can use the roadway to the point of closure. These signs should be accompanied by appropriate warning and detour signing.

In rural applications, the Local Traffic Only sign should have the legend ROAD CLOSED XX MI AHEAD, LOCAL TRAFFIC ONLY (R11-3A).

Option:

In urban areas, the legend ROAD CLOSED TO THRU TRAFFIC (R11-4) or ROAD CLOSED, __ MI AHEAD, LOCAL TRAFFIC ONLY may be used.

The words BRIDGE CLOSED may be substituted for the words ROAD CLOSED on the R11-3A or R11-4 sign where applicable.

Section F.10 Weight Limit Signs (R12-1, R12-5A)

Standard:

A Weight Limit sign, which shows the gross weight or axle weight that is permitted on the roadway or bridge, shall be consistent with State or local regulations and shall not be installed without the approval of the authority having jurisdiction over the highway.

When weight restrictions are imposed because of the activity in a temporary traffic control zone, a marked detour shall be provided for vehicles weighing more than the posted limit.

Section F.11 STAY IN LANE Sign (R4-9)

Option:

A STAY IN LANE (R4-9) sign may be used where a multilane shift has been incorporated as part of the temporary traffic control on a highway to direct road users around road work that occupies part of the roadway on a multilane highway.

Section F.12 Intentionally Left Blank

Section F.13 SIDEWALK CLOSED Signs (R9-9, R9-10, R9-11, R9-11A)

Guidance:

SIDEWALK CLOSED signs should be used where pedestrian flow is restricted. Bicycle/Pedestrian Detour signs or Pedestrian Detour signs should be used where pedestrian flow is rerouted (See Section F.53).

The SIDEWALK CLOSED (R9-9) sign should be installed at the beginning of the closed sidewalk, at the intersections preceding the closed sidewalk, and elsewhere along the closed sidewalk as needed.

The SIDEWALK CLOSED, (ARROW) USE OTHER SIDE (R9-10) sign should be installed at the beginning of the restricted sidewalk when a parallel sidewalk exists on the other side of the roadway.

The SIDEWALK CLOSED AHEAD, (ARROW) CROSS HERE (R9-11) sign should be used to indicate to pedestrians that sidewalks beyond the sign are closed and to direct them to open crosswalks, sidewalks, or other travel paths.

The SIDEWALK CLOSED, (ARROW) CROSS HERE (R9-11A) sign should be installed just beyond the point to which pedestrians are being redirected.

Support:

These signs are typically mounted on a detectable barricade to encourage compliance and to communicate with pedestrians that the sidewalk is closed. Printed signs are not useful to many pedestrians with visual disabilities. A barrier or barricade detectable by a person with a visual disability is sufficient to indicate that a sidewalk is closed. If the barrier is continuous with detectable channelizing devices for an alternate route, accessible signage might not be necessary. An audible information device is needed when the detectable barricade for an alternate channelized route is not continuous.

Section F.14 Special Regulatory Signs

Option:

Special regulatory signs may be used based on engineering judgment consistent with regulatory requirements.

Guidance:

Special regulatory signs should conform to the general requirements of color, shape, and alphabet size and series. The sign message should be brief, legible, and clear.



R1 - 1
36" x 36"
(48" x 48")



R1 - 2
36" x 36" x 36"
(48" x 48" x 48")



R2 - 1
36" x 48"
(48" x 60")



R3 - 1
36" x 36"
(24" x 24")



R3 - 2
36" x 36"
(24" x 24")



R3 - 3
36" x 36"
(24" x 24")



R3 - 4
36" x 36"
(24" x 24")



R3 - 5L
30" x 36"



R3 - 6L
30" x 36"



R3 - 7L
48" x 48"
(30" x 30")



R3 - 8DL
36" x 36"



R4 - 1
36" x 48"
(24" x 30")



R4 - 2
36" x 48"
(24" x 30")

COMMONLY USED REGULATORY SIGNS.

FIGURE 5A



R4 - 7
36" x 48"
(24" x 30")



R5 - 1
36" x 36"
(30" x 30")



R5 - 1A
36" x 24"
(42" x 30")

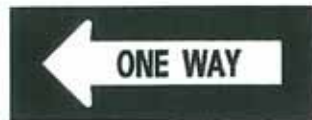

R6 - 1L
48" x 18"
(36" x 12")



R6 - 2R
24" x 30"
(18" x 24")

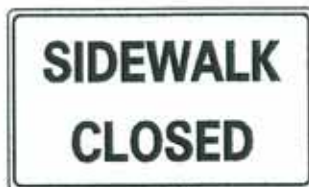

R9-9
30" x 18"

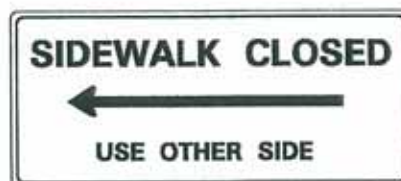

R9 - 10L
24" x 12"

COMMONLY USED REGULATORY SIGNS.
FIGURE 5B



R11-2
48" x 30"

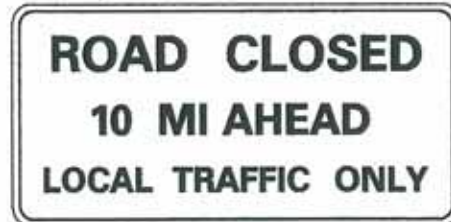

R11-3A
60" x 30"

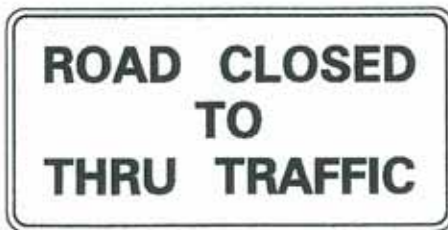

R11-4
60" x 30"



R12-1
36" x 48"
(24" x 30")



R12-5A
30" x 48"

COMMONLY USED REGULATORY SIGNS
FIGURE 5C

Section F.15 Warning Sign Function, Design, and Application

Support:

Temporary traffic control zone warning signs notify road users of specific situations or conditions on or adjacent to a roadway that might not otherwise be apparent.

Standard:

Temporary traffic control warning signs shall conform to the Standards for warning signs presented in Part 2 of “The Manual on Uniform Traffic Control Devices” and in the West Virginia Division of Highways “Sign Fabrication Details” book. Except as noted in the Option below, temporary traffic control warning signs shall be diamond-shaped with a black legend and border on an orange background, except for the W10-1 sign which shall have a black legend and border on a yellow background, and except for signs that are permitted in Parts 2 and 7 of the “Manual on Uniform Traffic Control Devices” to have fluorescent yellow-green backgrounds.

Option:

Mounting or space considerations may justify a change from the standard diamond shape.

In emergencies, available warning signs having yellow backgrounds may be used if signs with orange are not at hand.

Guidance:

Where roadway or road user conditions require greater emphasis, larger than standard size warning signs should be used, with the symbol or legend enlarged approximately in proportion to the outside dimensions.

Where any part of the roadway is obstructed or closed by work activities or incidents, advance warning signs should be installed to alert road users well in advance of these obstructions or restrictions.

Where road users include pedestrians, the provision of supplemental audible information or detectable barriers or barricades should be considered for people with visual disabilities.

Support:

Detectable barriers or barricades communicate very clearly to pedestrians who have visual disabilities that they can no longer proceed in the direction that they are traveling.

Option:

Advance warning signs may be used singly or in combination.

Standard:

Because of their importance, advance warning signs for higher-speed locations shall have a size of 48 x 48 in.

For freeways and expressway, the size of the diamond shaped temporary traffic control warning signs shall be a minimum of 48 x 48 in.

Option:

Where speeds and volumes are moderately low, a minimum size of 36 x 36 in. may be used for advance warning signs.

On secondary roads or city streets where speeds are very low, signs smaller than the standard size, but not less than 24 x 24 in., may be used for warning signs having short word messages or clear symbols.

Advance warning signs larger than the minimum standards may be used for additional emphasis of the temporary traffic control zone (see Part 2 of the "Manual on Uniform Traffic Control Devices").

Where distances are not shown on warning signs as part of the message, a supplemental plaque with the distance legend may be mounted immediately below the sign on the same support.

Section F.16 Position of Advance Warning Signs

Guidance:

Where highway conditions permit, warning signs should be placed in advance of the temporary traffic control zone at varying distances depending on roadway type, condition, and posted speed. Table 1 contains information regarding the spacing of advance warning signs. Where a series of two or more advance warning signs is used, the closest sign to the temporary traffic control zone should be placed approximately 100 ft. for low-speed urban streets to 1,000 ft. or more for expressways and freeways.

Support:

Various conditions, such as limited sight distance or obstructions that might require a driver to reduce speed or stop, might require additional advance warning signs.

Option:

As an alternative to a specific distance on advance warning signs, the word AHEAD may be used.

Support:

At temporary traffic control zones on lightly-traveled roads, all of the advance warning signs prescribed for major construction might not be needed.

Option:

Utility work, maintenance, or minor construction can occur within the temporary traffic control zone limits of a major construction project, and additional warning signs may be needed.

Guidance:

Utility, maintenance, and minor construction signing and temporary traffic control should be coordinated with appropriate authorities so that road users are not confused or misled by the additional temporary traffic control devices.

Section F.17 ROAD WORK Sign (W20-1)

Guidance:

The ROAD WORK (W20-1) sign, which serves as a general warning of obstructions or restrictions, should be located in advance of the work space or any detour, on the road where the work is taking place.

Where traffic can enter a temporary traffic control zone from a crossroad or a major (high-volume) driveway, an advance warning sign may be used on the crossroad or major driveway.

Standard:

The ROAD WORK (W20-1) sign shall have the legend ROAD WORK, XX FT, XX MILES, or AHEAD.

Section 6F.18 DETOUR Sign (W20-2)

Guidance:

The DETOUR (W20-2) sign should be used in advance of a road user detour over a different roadway or route.

Standard:

The DETOUR sign shall have the legend DETOUR, XX FT, XX MILES, or AHEAD.

Section F.19 ROAD CLOSED Sign (W20-3)

Guidance:

The ROAD CLOSED (W20-3) sign should be used in advance of the point where a highway is closed to all road users, or to all but local road users.

Standard:

The ROAD CLOSED sign shall have the legend ROAD CLOSED, XX FT, XX MILES, or AHEAD.

Section F.20 ONE LANE ROAD Sign (W20-4)

Standard:

The ONE LANE ROAD (W20-4) sign shall be used only in advance of that point where motor vehicle traffic in both directions must use a common single lane (see Section C.10). It shall have the legend ONE LANE ROAD, XX FT, XX MILES, or AHEAD.

Section F.21 LANE(S) CLOSED Signs (W20-5, W20-5A)

Standard:

The LANE(S) CLOSED sign shall be used in advance of that point where one or more through lanes of a multiple-lane roadway are closed.

For a single lane closure, the LANE CLOSED (W20-5) sign shall have the legend RIGHT (LEFT) LANE CLOSED, XX FT, XX MILES, or AHEAD. Where two adjacent lanes are closed, the sign shall have the legend RIGHT (LEFT) TWO LANES CLOSED, XX FT, XX MILES, or AHEAD.

Section F.22 CENTER LANE CLOSED AHEAD Signs (W20-5C)

Guidance:

The CENTER LANE CLOSED AHEAD (W20-5C) sign should be used in advance of that point where work occupies the center lane(s) and approaching motor vehicle traffic is directed to the right or left of the work zone in the center lane.

Option:

The Center Lane Closed Ahead (W20-12B) symbol sign may be substituted for the CENTER LANE CLOSED AHEAD (W20-5C) word message sign.

Section F.23 THRU TRAFFIC MERGE RIGHT (LEFT) Sign (W4-7)

Guidance:

The THRU TRAFFIC MERGE RIGHT (LEFT) (W4-7) sign should be used in advance of an intersection where one or more lane closures on the far side of a multilane intersection require through vehicular traffic on the approach to the intersection to use the right (left) lane to proceed through the intersection.

Section F.24 Lane Ends Sign (W4-2)

Option:

The Lane Ends (W4-2) symbol sign may be used to warn drivers of the reduction in the number of vehicular traffic lanes in the direction of travel on a multilane roadway.

Section F.25 ON RAMP Plaque (W20-1A)

Guidance:

When work is being done on a ramp, but the ramp remains open, the ON RAMP (W20-1A) plaque should be used to supplement the advance ROAD WORK sign.

Section F.26 RAMP NARROWS Sign (W5-1B)

Guidance:

The RAMP NARROWS (W5-1B) sign should be used in advance of the point where work on a ramp reduces the normal width of the ramp along a part or all of the ramp.

Section F.27 Intentionally Left Blank

Section F.28 EXIT OPEN, EXIT CLOSED Signs (W22-10A, W22-10)

Option:

An EXIT OPEN (W22-10A) or EXIT CLOSED (W22-10) sign may be used to supplement other warning signs where work is being conducted in the vicinity of an exit ramp and where the exit maneuver for motor vehicle traffic using the ramp is different from the normal condition.

Guidance:

When an exit ramp is closed, and EXIT CLOSED panel with black legend and border on an orange background should be placed diagonally across the interchange/intersection guide signs.

Section F.29 Flagger Sign (W20-7A)

Guidance:

The Flagger (W20-7A) symbol sign should be used in advance of any point where a flagger is stationed to control road users.

Option:

A distance legend may be displayed on a supplemental plaque below the Flagger sign. The sign may be used with appropriate legends or in conjunction with other warning signs, such as the BE PREPARED TO STOP (W22-12) sign.

Standard:

The Flagger sign shall be removed, covered, or turned away from road users when the flagging operations are not occurring.

Section F.30 Two-Way Traffic Sign (W6-3)

Guidance:

When one roadway of a normally divided highway is closed, with two-way motor vehicle traffic maintained on the other roadway, the Two-Way Traffic (W6-3) sign should be used at the beginning of the two-way motor vehicle traffic section and at intervals to remind road users of opposing vehicular traffic.

Section F.31 Workers Sign (W21-1A)

Option:

A Workers (W21-1A) symbol sign may be used to alert road users of workers in or near the roadway.

Guidance:

In the absence of other warning devices, a Workers symbol sign should be used when workers are in the roadway.

Section F.32 FRESH TAR Sign (W21-2)

Guidance:

The FRESH TAR (W21-2) sign should be used to warn road users of the surface treatment.

Section F.33 Intentionally Left Blank

Section F.34 Intentionally Left Blank

Section F.35 Shoulder Work Signs (W21-5A, W21-5B, WV 21-5C)

Support:

Shoulder Work signs warn of maintenance, reconstruction, or utility operations on the highway shoulder where the roadway is unobstructed.

Standard:

The Shoulder Work sign shall have the legend SHOULDER WORK (W21-5), RIGHT (LEFT) SHOULDER CLOSED (W21-5A), or RIGHT (LEFT) SHOULDER CLOSED XXX FT (W21-5B), or SHOULDER WORK AHEAD (W21-5C).

Option:

The Shoulder Work sign may be used in advance of the point on a nonlimited access highway where there is shoulder work. It may be used singly or in combination with a ROAD WORK NEXT X MILES or ROAD WORK AHEAD sign.

Guidance:

On expressways and freeways, the RIGHT (LEFT) SHOULDER CLOSED XXX FT or AHEAD sign followed by RIGHT (LEFT) SHOULDER CLOSED sign should be used in advance of the point where the shoulder work occurs and should be preceded by a ROAD WORK AHEAD sign.

Section F.36 SURVEY CREW Sign (W21-6)

Guidance:

The SURVEY CREW (W21-6) sign should be used to warn of surveying crews working in or adjacent to the roadway.

Section F.37 UTILITY WORK Sign (W21-7)

Option:

The UTILITY WORK (W21-7) sign may be used as an alternate to the ROAD WORK (W20-1) sign for utility operations on or adjacent to a highway.

Support:

Typical examples of where the UTILITY WORK sign is used appear in Cases C-1, C-2, C-3, and C-4.

Standard:

The UTILITY WORK sign shall carry the legend UTILITY WORK, XX FT, XX MILES, or AHEAD.

Section F.38 Signs for Blasting Areas

Support:

Radio-Frequency (RF) energy can cause the premature firing of electric detonators (blasting caps) used in temporary traffic control zones.

Standard:

Road users shall be warned to turn off mobile radio transmitters and cellular telephones where blasting operations occur. A sequence of signs shall be prominently displayed to direct operators of mobile radio equipment, including cellular telephones, to turn off transmitters in a blasting area. These signs shall be covered or removed when there are no explosives in the area or the area is otherwise secured.

Section F.39 BLASTING ZONE AHEAD Sign (W22-1)

Standard:

The BLASTING ZONE AHEAD (W22-1) sign shall be used in advance of any temporary traffic control zone where explosives are being used. The TURN OFF 2-WAY RADIO AND CELL PHONE and END BLASTING ZONE signs shall be used in sequence with this sign.

Section F.40 TURN OFF 2-WAY RADIO AND CELL PHONE Sign (W22-2)

Standard:

The TURN OFF 2-WAY RADIO AND CELL PHONE (W22-2) sign shall follow the BLASTING ZONE AHEAD sign and shall be placed at least 1,000 ft before the beginning of the blasting zone.

Section F.41 END BLASTING ZONE Sign (W22-3)

Standard:

The END BLASTING ZONE (W22-3) sign shall be placed a minimum of 1,000 ft past the blasting zone.

Option:

The END BLASTING ZONE sign may be placed either with or preceding the END ROAD WORK sign.

Section F.42 Shoulder Signs (W8-4, W8-9, W21-5A)

Option:

The SOFT SHOULDER (W8-4) sign may be used to warn of a soft shoulder condition.

The LOW SHOULDER (W8-9) sign may be used to warn of a shoulder condition where there is an elevation difference of less than 3 in. between the shoulder and the travel lane.

Guidance:

The SHOULDER DROP-OFF (W21-5D) sign shall be used when an unprotected shoulder dropoff, adjacent to the travel lane, exceeds 3 in. in depth for a continuous length along the roadway based on engineering judgment.

Section F.43 UNEVEN LANES Sign (W22-18)

Guidance:

The UNEVEN LANES (W8-11) sign should be used during operations that create a substantial difference in elevation between adjacent lanes that are open to travel.

Section F.44 Intentionally Left Blank

Section F.45 Intentionally Left Blank

Section F.46 Other Warning Signs

Option:

Advance warning signs may be used by themselves or with other advance warning signs.

Besides the warning signs specifically related to temporary traffic control zones, several other warning signs in Part 2 of the "Manual of Uniform Traffic Control Devices" may apply in temporary traffic control zones.

Standard:

Except as noted in Section F.02, other warning signs that are used in temporary traffic control zones, shall have black legends and borders on an orange background.

Section F.47 Special Warning Signs

Option:

Special warning signs may be used based on engineering judgment.

Guidance:

Special warning signs should conform to the general requirements for color, shape, and alphabet size and series. The sign message should be brief, legible, and clear.

Section F.48 Advisory Speed Plaque (W13-1)

Option:

In combination with a warning sign, an Advisory Speed (W13-1) plaque may be used to indicate a recommended safe speed through the temporary traffic control zone.

Standard:

The Advisory Speed plaque shall not be used in conjunction with any sign other than a warning sign, nor shall it be used alone. When used with orange temporary traffic control zone signs, this plaque shall have a black legend and border on an orange background. The sign shall be at least 24 x 24 in. in size when used with a sign that is 36 x 36 in. or larger. Except in emergencies, an Advisory Speed plaque shall not be mounted until the recommended speed is determined by the highway agency.

Section F.49 Supplementary Distance Plaque (W7-3A)

Option:

In combination with a warning sign, a Supplementary Distance (W7-3a) plaque with the legend NEXT XX MI may be used to indicate the length of highway over which a work activity is being conducted, or over which a condition exists in the temporary traffic control zone.

In long temporary traffic control zones, Supplementary Distance plaques with the legend NEXT XX MI may be placed in combination with warning signs at regular intervals within the zone to indicate the remaining length of highway over which the temporary traffic control work activity or condition exists.

Standard:

The Supplementary Distance plaque with the legend NEXT XX MI shall not be used in conjunction with any sign other than a warning sign, nor shall it be used alone. When used with orange temporary traffic control zone signs, this plaque shall have a black legend and border on an orange background. The sign shall be at least 30 x 24 in. in size when used with a sign that is 36 x 36 in. or larger.

Guidance:

When used in temporary traffic control zones, the Supplementary Distance plaque with the legend NEXT XX MI should be placed below the initial warning sign designating that, within the approaching zone, a temporary work activity or condition exists.



W1 - 1R
48" x 48"



W1 - 2R
48" x 48"



W1 - 3R
48" x 48"



W1 - 4R
48" x 48"



W20 - 12R
48" x 48"



W1 - 6
72" x 36"
(48" x 24")



W1 - 8
30" x 36"
(24" x 30")



W3 - 1
48" x 48"
(36" x 36")



W3 - 2
48" x 48"
(36" x 36")



W3 - 3
48" x 48"



W4 - 1R
48" x 48"



W4 - 2R
48" x 48"



W4 - 3R
48" x 48"



W5 - 1
36" x 36"

WARNING SIGNS USED IN TEMPORARY TRAFFIC CONTROL ZONES.
FIGURE 6A



W6 - 3
48" x 48"
(36" x 36")



W6 - 1
48" x 48"
(36" x 36")



W6 - 2
48" x 48"
(36" x 36")



W7 - 1B
48" x 48"
(36" x 36")



W8 - 1
48" x 48"
(30" x 30")



W8 - 2
48" x 48"
(30" x 30")



W8 - 3
48" x 48"
(36" x 36")



W8 - 4
48" x 48"
(36" x 36")



W8 - 5
48" x 48"
(36" x 36")



W8 - 7
48" x 48"
(36" x 36")



W8 - 8
48" x 48"
(36" x 36")



W8 - 9
48" x 48"
(36" x 36")

WARNING SIGNS USED IN TEMPORARY TRAFFIC CONTROL ZONES.
FIGURE 6B



W9 - 1R
48" x 48"
(36" x 36")



W10 - 1
36" DIAMETER



W12 - 1
36" x 36"
(30" x 30")



W12 - 2
48" x 48"
(36" x 36")



W14 - 3
36" x 48" x 48"



W22 - 12
48" x 48"

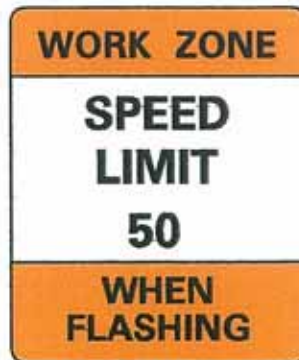

R2-1M
36" x 78"

WARNING SIGNS USED IN TEMPORARY TRAFFIC CONTROL ZONES.
FIGURE 6C



W6-3
48" x 48"



W20-2
48" x 48"



W20-3
48" x 48"



W20-4
48" x 48"



W20-5
48" x 48"



W20-7A
48" x 48"
SUPPLEMENTAL PLAQUE
W5-7
24" x 18"



W20-1
48" x 48"

WARNING SIGNS USED IN TEMPORARY TRAFFIC CONTROL ZONES
FIGURE 6D



W21-1A
48" x 48"
(36" x 36")



W21-2
36" x 36"



W21-5
48" x 48"



W21-6
48" x 48"
(36" x 36")

WARNING SIGNS USED IN TEMPORARY TRAFFIC CONTROL ZONES
FIGURE 6E



W21-5D
48" x 48"



W22-18
48" x 48"



W13-1
24" x 24"
(18" x 18")



W22-1
48" x 48"



W22-2
48" x 36"



W22-3
42" x 36"

WARNING SIGNS USED IN TEMPORARY TRAFFIC CONTROL ZONES
FIGURE 6F

Section F.50 Guide Signs

Support:

Guide signs along highways provide road users with information to help them along their way through the temporary traffic control zone. The design of guide signs is presented in Part 2 of the "Manual on Uniform Traffic Control Devices."

Guidance:

The following guide signs should be used in temporary traffic control zones as needed:

- A. Standard route markings, where temporary route changes are necessary;
- B. Directional signs and street name signs; and
- C. Special guide signs relating to the condition or work being done.

Standard:

If additional guide signs are used in temporary traffic control zones, they shall have a black legend and border on an orange background.

Option:

When directional signs and street name signs are used in conjunction with detour routing these signs may have a black legend and border on an orange background.

When permanent directional signs or permanent street name signs are used in conjunction with detour signing, they may have a white legend on a green background.

Section F.51 ROAD WORK NEXT XX MILES Sign (G20-1)

Guidance:

The ROAD WORK NEXT XX MILES (G20-1) sign should be installed in advance of temporary traffic control zones that are more than 2 mi. in length.

Option:

The ROAD WORK NEXT XX MILES sign may be mounted on a Type III barricade. The sign may also be used for temporary traffic control zones of shorter length.

Standard:

The distance shown on the ROAD WORK NEXT XX MILES sign shall be stated to the nearest whole mile.

Section F.52 END ROAD WORK Sign (G20-2)

Guidance:

When used, the END ROAD WORK (G20-2) sign should be placed at the end of the termination area, as determined by engineering judgement.

Option:

The END ROAD WORK sign may be installed on the back of a warning sign facing the opposite direction of road users or on the back of a Type III barricade.

Section F.53 Detour Signs (M4-8, M4-8A, M4-9, M4-9R, M4-9L, M4-9S, and M4-10)

Standard:

Each detour shall be adequately marked with standard temporary route markers and destination signs.

Option:

The Detour Arrow (M4-10) sign may be used where a detour route has been established.

The DETOUR (M4-8) sign may be mounted at the top of a route sign assembly to mark a temporary route that detours from a highway, bypasses a section closed by a temporary traffic control zone, and rejoins the highway beyond the temporary traffic control zone.

Guidance:

The Detour Arrow (M4-10) sign should normally be mounted just below the ROAD CLOSED (R11-2, R11-3A, or R11-4) sign. The Detour Arrow sign should include a horizontal arrow pointed to the right or left as required.

The DETOUR (M4-9) series signs should be used for unnumbered highways, for emergency situations, for periods of short durations, or where, over relatively short distances, road users are guided along the detour and back to the desired highway without route markers.

A Street Name sign should be placed above, or the street name should be incorporated into, a DETOUR (M4-9) sign to indicate the name of the street being detoured.

Option:

The END DETOUR (M4-8A) sign may be used to indicate that the detour has ended.

Guidance:

When the END DETOUR sign is used on a numbered highway, the sign should be mounted above a sign after the end of the detour.

Section F.54 PILOT VEHICLE FOLLOW ME Sign (G20-4A)

Standard:

The PILOT VEHICLE FOLLOW ME (G20-4A) sign shall be mounted in a conspicuous position on the rear of a vehicle used for guiding one-way vehicular traffic through or around a temporary traffic control zone. A flagger shall be stationed on the approach to the activity area to stop vehicular motor vehicle traffic until the pilot vehicle is available.

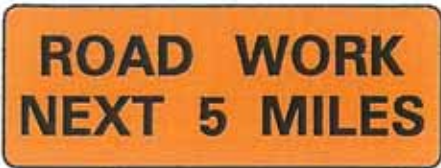

G20-1
60" x 24"



G20-2
36" x 18"



G20-4A
42" x 18"



M4-6
24" x 12"
(30" x 15")



M4-8
24" x 12"
(30" x 15")



M4-8A
42" x 24"



M4-9R
30" x 24"



M4-10R
48" x 18"

COMMONLY USED GUIDE SIGNS
FIGURE 6G

Section F.55 Portable Changeable Message Signs

Standard:

Portable Changeable Message signs shall be temporary traffic control devices with the flexibility to display a variety of messages. Each message shall consist of either one or two phases. A phase shall consist of up to three lines of eight characters per line. Each character module shall use at least a five wide and seven high pixel matrix.

Support:

Portable Changeable Message signs are used most frequently on high-density urban freeways, but have applications on all types of highways where highway alignment, road user routing problems, or other pertinent conditions require advance warning and information.

Portable Changeable Message signs have a wide variety of applications in temporary traffic control zones including: roadway, lane, or ramp closures, crash or emergency incident management, width restriction information, speed control or reductions, advisories on work scheduling, road user management, and diversion warning on adverse conditions or special events, and other operational control.

The primary purpose of Portable Changeable Message signs in temporary traffic control zones is to advise the road user of unexpected situations. Some typical applications include the following:

- A. Where the speed of vehicular traffic is expected to drop substantially;
- B. Where significant queuing and delays are expected;
- C. Where adverse environmental conditions are present;
- D. Where there are changes in alignment or surface conditions;
- E. Where advance notice of ramp, lane, or roadway closures is needed;
- F. Where crash or incident management is needed; and/or
- G. Where changes in the road user pattern occur.

Guidance:

The components of a Portable Changeable Message sign should include: a message sign panel, control systems, a power source, and mounting and transporting equipment.

Portable Changeable Message signs should subscribe to the principles established in Section 2A-07 and other sections of the "Manual on Uniform Traffic Control Devices" and, to the extent practical, with the design (that is, color, letter size and shape, and

borders) and applications prescribed in this Manual, except that the reverse colors for the letter and background are considered acceptable.

The front face of the sign should be covered with a protective material. The color of the elements should be yellow or orange on a black background.

Portable Changeable Message signs should be visible from 0.5 mi under both day and night conditions. For a trailer or large truck mounted sign, the letter height should be a minimum of 18 in. For Changeable Message signs mounted on service patrol trucks, the letter height should be a minimum of 10 in.

The message panel should have adjustable display rates (minimum of 3 seconds per phase), so that the entire message can be read at least twice at the posted speed, the off-peak 85th-percentile speed prior to work starting, or the anticipated operating speed.

Messages should be designed taking into account the following factors:

- A. Each phase should convey a single thought.
- B. If the message can be displayed in one phase, the top line should present the problem, the center line should present the location or distance ahead, and the bottom line should present the recommended driver action.
- C. The message should be as brief as possible.
- D. When a message is longer than two phases, additional Portable Changeable Message signs should be used.
- E. When abbreviations are used, they should be easily understood.

Option:

The message sign panel may vary in size.

Smaller letter sizes may be used on a Portable Changeable Message sign mounted on a trailer or large truck provided that the message is legible from at least 650 ft., or mounted on a service patrol truck provided that the message is legible from at least 330 ft.

Two Portable Changeable Message signs may be used for the purpose of allowing the entire message to be read twice at the posted speed.

Standard:

Portable Changeable Message signs shall automatically adjust their brightness under varying light conditions, to maintain legibility.

The control system shall include a display screen upon which messages can be reviewed before being displayed on the message sign. The control system shall be capable of maintaining memory when power is unavailable.

Portable Changeable Message signs shall be equipped with a power source and a battery back-up to provide continuous operation when failure of the primary power source occurs.

The mounting of Portable Changeable Message signs on a trailer, a large truck, or a service patrol truck shall be such that the bottom of the message sign panel shall be a minimum of 7 ft. above the roadway in urban areas and 5 ft. above the roadway in rural areas when it is in the operating mode.

The text of the messages shall not scroll or travel horizontally or vertically across the face of the sign.

Guidance:

Portable Changeable Message signs should be used as a supplement to and not as a substitute for conventional signs and pavement markings.

When Portable Changeable Message signs are used for route diversion, they should be placed far enough in advance of the diversion to allow road users ample opportunity to perform necessary lane changes, to adjust their speed, or to exit the affected highway.

The Portable Changeable Message signs should be sited and aligned to provide maximum legibility. Multiple Portable Changeable Message signs should be placed on the same side of the roadway, separated from each other at distances based on Table 1.

Portable Changeable Message signs should be placed on the shoulder of the roadway or, if practical, further from the traveled lane. They should be delineated with retroreflective temporary traffic control devices. When Portable Changeable Message signs are not being used, they should be removed; if not removed, they should be shielded; or if the previous two options are not feasible, they should be delineated with retroreflective temporary traffic control devices.

Portable Changeable Message sign trailers should be delineated on a permanent basis by affixing retroreflective material, known as conspicuity material, in a continuous line on the face of the trailer as seen by oncoming road users.

Section F.56 Arrow Panels (Electric Arrows)

Standard:

An arrow panel shall be a sign with a matrix of elements capable of either flashing or sequential displays. This sign shall provide additional warning and directional information to assist in merging and controlling road users through or around a temporary traffic control zone.

Guidance:

An arrow panel in the arrow mode should be used to advise approaching traffic of a lane closure along major multilane roadways in situations involving heavy traffic volumes, high speeds, and/or limited sight distances, or at other locations and under other conditions where road users are less likely to expect such lane closures.

If used, arrow panel should be used in combination with appropriate signs, channelizing devices, or other temporary traffic control devices.

An arrow panel should be placed on the shoulder of the roadway or, if practical, further from the traveled lane. It should be delineated with retroreflective temporary traffic control devices. When an arrow panel is not being used, it should be removed; if not removed, it should be shielded; or if the previous two options are not feasible, it should be delineated with retroreflective temporary traffic control devices.

Standard:

Arrow panels shall meet the minimum size, legibility distance, number of elements, and other specifications shown on Figure 7.

Support:

Type A arrow panels are appropriate for use on low-speed urban streets. Type B arrow panels are appropriate for intermediate-speed facilities and for maintenance or mobile operations on high-speed roadways. Type C arrow panels are intended to be used on high-speed, high-volume motor vehicle traffic control projects. Type D arrow panels are intended for use on authorized vehicles. Normally use Type C Arrow panels.

Standard:

Type A, B, and C arrow panels shall have solid rectangular appearances. A Type D arrow panel shall conform to the shape of the arrow.

All arrow panels shall be finished in nonreflective black. The arrow panel shall be mounted on a vehicle, a trailer, or other suitable support.

Guidance:

The minimum mounting height of an arrow panel should be 7 ft from the roadway to the bottom of the panel, except on vehicle-mounted panels, which should be as high as practical.

A vehicle-mounted arrow panel should be provided with remote controls.

Standard:

Arrow panel elements shall be capable of at least a 50 percent dimming from full brilliance. The dimmed mode shall be used for nighttime operation of arrow panels.

Guidance:

Full brilliance should be used for daytime operation of arrow panels.

Standard:

The arrow panel shall have suitable elements capable of the various operating modes. The color presented by the elements shall be yellow.

Guidance:

If an arrow panel consisting of a bulb matrix is used, the elements should be recess-mounted or equipped with an upper hood of not less than 180 degrees.

Standard:

The minimum element on-time shall be 50 percent for the flashing mode, with equal intervals of 25 percent for each sequential phase. The flashing rate shall be not less than 25 nor more than 40 flashes per minute.

An arrow panel shall have the following three mode selections:

- A. A Flashing Arrow mode; and**
- B. A flashing Double Arrow mode; and**
- C. A flashing Caution mode.**

An arrow panel in the arrow mode shall be used only for stationary or moving lane closures on multilane roadways.

For shoulder work, blocking the shoulder, for roadside work near the shoulder, or for temporarily closing one lane on a two-lane, two-way roadway, an arrow panel shall be used only in the caution mode.

Option:

A Sequential Arrow shall be an option in lieu of a Flashing Arrow.

Guidance:

For a stationary lane closure, the arrow panel should be located on the shoulder at the beginning of the merging taper.

Where the shoulder is narrow, the arrow panel should be located in the closed lane.

Standard:

When arrow panels are used to close multiple lanes, a separate arrow panel shall be used for each closed lane.

Guidance:

When arrow panels are used to close multiple lanes, if the first arrow panel is placed on the shoulder, the second arrow panel should be placed in the first closed lane at the beginning of the second merging taper (see Case E5). When the first arrow panel is placed in the first closed lane, the second arrow panel should be placed in the second closed lane at the downstream end of the second merging taper.

For mobile operations where a lane is closed, the arrow panel should be located to provide adequate separation from the work operation to allow for appropriate reaction by approaching drivers.

Standard:

A vehicle displaying an arrow panel shall be equipped with high-intensity rotating, flashing, oscillating or strobe lights.

Arrow panels shall not be used to laterally shift traffic.

Option:

A portable changeable message sign may be used to simulate an arrow panel display.

FIGURE 7. ADVANCE WARNING ARROW DISPLAY SPECIFICATIONS

OPERATING MODE

PANEL DISPLAY

I. AT LEAST ONE OF THE TWO FOLLOWING MODES SHALL BE PROVIDED:

(RIGHT ARROW SHOWN; LEFT IS SIMILAR)

FLASHING ARROW



MOVEMERGE RIGHT

SEQUENTIAL ARROW



MOVEMERGE RIGHT

II. THE FOLLOWING MODE SHALL BE PROVIDED:
FLASHING DOUBLE ARROW



MOVEMERGE RIGHT OR LEFT

III. THE FOLLOWING MODE SHALL BE PROVIDED:
FLASHING CAUTION



CAUTION

OR



CAUTION

<u>PANEL TYPE</u>	<u>MINIMUM SIZE</u>	<u>MINIMUM LEGIBILITY DISTANCE</u>	<u>MINIMUM NUMBER OF ELEMENTS</u>
A	48 X 24 IN.	1/2 MI.	12
B	60 X 30 IN.	3/4 MI.	13
C	96 X 48 IN.	1 MI.	15
D	NONE*	1/2 MI.	12

* LENGTH OF ARROW EQUALS 48 IN, WIDTH OF ARROWHEAD EQUALS 24 IN.

Section F.57 High-Level Warning Devices (Flag Trees)

Option:

A high-level warning device (flag tree) may supplement other temporary traffic control devices in temporary traffic control zones.

Support:

A high-level warning device is designed to be seen over the top of typical passenger cars. A typical high-level warning device is shown in Figure 8-Detail "A".

Standard:

A high-level warning device shall consist of a minimum of two flags with or without a Type B high-intensity flashing warning light. The distance from the roadway to the bottom of the lens of the light and to the lowest point of the flag material shall be not less than 8 ft. The flag shall be 16 in. square or larger and shall be orange or fluorescent orange in color.

Option:

An appropriate warning sign may be mounted below the flags.

Support:

High-level warning devices are most commonly used in high-density road user situations to warn road users of short-term operations.

Section F.58 Channelizing Devices

Standard:

Designs of various channelizing devices shall be as shown in Figure 8-Detail "A".

Support:

The function of channelizing devices is to warn road users of conditions created by work activities in or near the roadway and to guide road users. Channelizing devices include cones, tubular markers, vertical panels, drums, barricades, and temporary raised islands.

Channelizing devices provide for smooth and gradual vehicular traffic flow from one lane to another, onto a bypass or detour, or into a narrower traveled way. They are also used to separate vehicular traffic from the work space, pavement drop-offs, pedestrian or shared-use paths, or opposing directions of vehicular vehicle traffic.

Standard:

Devices used to channelize pedestrians shall be detectable to users of long canes and visible to persons having low vision.

Where barricades are used to channelize pedestrians, there shall be continuous detectable bottom and top rails with no gaps between individual barricades to be detectable to users of long canes. The bottom of the bottom rail shall be no higher than 6 in. above the ground surface. The top of the top rail shall be no lower than 36 in. above the ground surface.

Option:

A gap not exceeding 6 inches between the bottom rail and the ground surface may be used to facilitate drainage.

Standard:

If drums, cones, or tubular markers are used to channelize pedestrians, they shall be located such that there are no gaps between the bases of the devices, in order to create a continuous bottom, and the height of each individual drum, cone, or tubular marker shall be no less than 36 in. to be detectable to users of long canes.

Guidance:

Channelizing devices should be constructed and ballasted to perform in a predictable manner when inadvertently struck by a vehicle. Channelizing devices should be crashworthy. Fragments or other debris from the device or the ballast should not pose a significant hazard to road users or workers.

Generally, the spacing of channelizing devices is shown on each Case within this manual. For those situations where the channelizing device spacing is not shown, or adjustments are needed, the following information applies. The spacing of channelizing devices should not exceed a distance in feet equal to 1.0 times the speed limit in mph when used for taper channelization. For tangent channelization, the spacing of channelizing devices should not exceed a distance in feet equal to 2.0 times the speed limit in mph, (2S) with an absolute maximum spacing of 100 ft., where 2S results in a spacing distance greater than 100 ft. The speed limit used for these computations should be based upon the permanent speed limit in effect prior to the work zone operation.

When channelizing devices have the potential of leading vehicular traffic out of the intended vehicular traffic space, the channelizing devices should be extended a distance in feet of 2.0 times the speed limit mph beyond the end of the transition area.

Option:

Warning lights may be added to channelizing devices in areas with frequent fog, snow, or severe roadway curvature, or where visual distractions are present.

BARRICADE TYPES

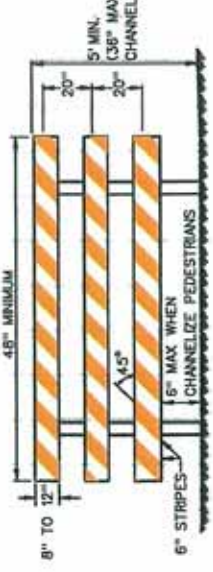
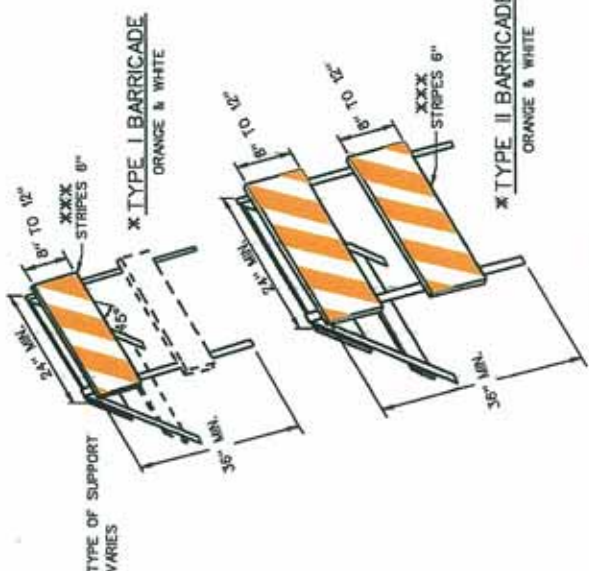

CHANNELIZING DEVICES

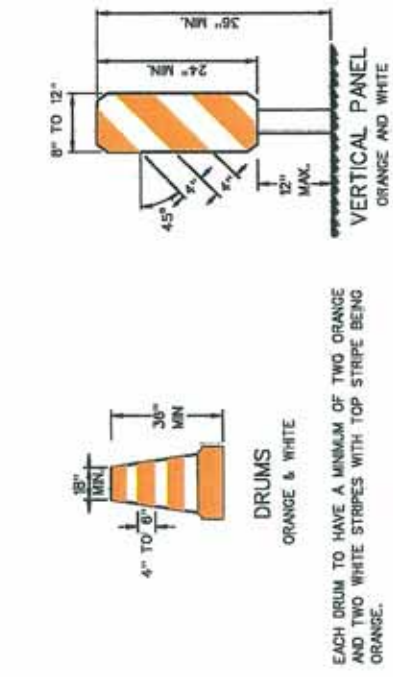
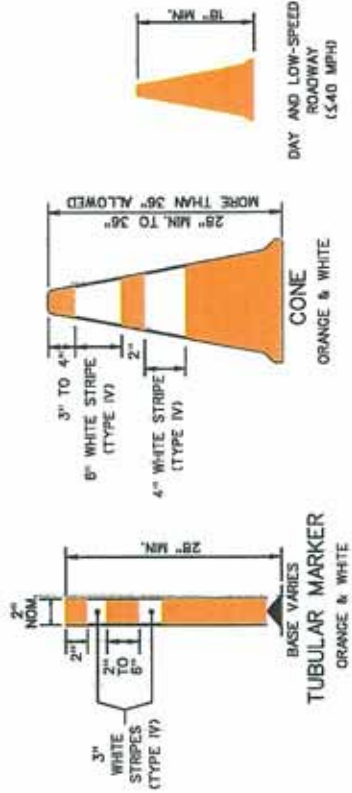

BARRICADE NOTES

- BARRICADE LEGS OR SUPPORTS SHALL BE CONSTRUCTED OF LIGHTWEIGHT MATERIAL AND SHALL BE GALVANIZED OR WHITE IN COLOR.
- ALL REFLECTORIZED MATERIAL SHALL HAVE A SMOOTH SEALED SURFACE COVERING THE REFLECTIVE ELEMENTS (TYPE IV SHEETING).
- ALL BARRICADES SHALL HAVE ALTERNATED ORANGE AND WHITE REFLECTORIZED STRIPES AT 45° FROM VERTICAL.
- TYPE I OR TYPE II BARRICADES SHALL BE STRIPED ON BOTH SIDES IF FACING TRAFFIC IN BOTH DIRECTIONS.
- DIAGONAL STRIPES ON THE BARRICADES SHALL SLOPE DOWN TOWARD THE SIDE OF THE BARRICADES ON WHICH TRAFFIC WILL PASS.
- SIGNS AND SUPPORTS MOUNTED ON BARRICADES SHALL BE ATTACHED WITH GALVANIZED BOLTS, NUTS AND WASHERS.
- WHERE DRUMS, CONES, OR TUBULAR MARKERS ARE USED TO CHANNELIZE PEDESTRIANS, THEY SHALL BE LOCATED SUCH THAT THERE ARE NO GAPS BETWEEN THE BASES OF THE DEVICES, IN ORDER TO CREATE A CONTINUOUS BOTTOM, AND THE HEIGHT OF EACH INDIVIDUAL DRUM, CONE, OR TUBULAR MARKER SHALL BE NO LESS THAN 36 IN. TO BE DETECTABLE TO USERS OF LONG LANES.

*** BARRICADE CHARACTERISTICS

	TYPE I	TYPE II	TYPE III
NUMBER OF REFLECTORIZED RAIL FACES	TWO (ONE IN EACH DIRECTION)	FOUR (TWO IN EACH DIRECTION)	3 IF FACING TRAFFIC ONE DIRECTION 6 IF FACING TRAFFIC BOTH DIRECTIONS
WIDTH OF RAIL	8" MIN. - 12" MAX.	8" MIN. - 12" MAX.	8" MIN. - 12" MAX.
LENGTH OF RAIL	24" MINIMUM VARIABLE MAXIMUM	24" MINIMUM VARIABLE MAXIMUM	48" MINIMUM VARIABLE MAXIMUM
WIDTH OF STRIPES	6" X X	6" X X	6"
HEIGHT	3' MIN.	3' MIN.	5' MIN.
TYPE OF FRAME	DEMOUNTABLE OR "A" FRAME	LIGHT "A" FRAME	POST OR SKIDS
FLEXIBILITY	ESSENTIALLY MOVABLE	PORTABLE	ESSENTIALLY PERMANENT

X COMMERCIAL MANUFACTURED BARRICADES MAY BE USED PROVIDED APPROXIMATE SIZE, COLOR AND REFLECTIVITY IS CORRECT.
 X X FOR RAILS LESS THAN 3' LONG, 4" WIDE STRIPES MAY BE USED.
 X X X WHEN USED TO CHANNELIZE PEDESTRIANS, THERE SHALL BE CONTINUOUS DETECTABLE BOTTOM AND TOP RAILS WITH NO GAPS BETWEEN INDIVIDUAL BARRICADES, TO BE DETECTABLE TO USERS OF LONG LANES.

CHANNELIZING NOTES

- THE STRIPES ON THE VERTICAL PANEL SHALL BE TYPE II AND SLOPE DOWN TOWARD THE SIDE OF THE PANEL ON WHICH TRAFFIC IS TO PASS.
- THE STRIPES ON THE DRUMS SHALL BE HORIZONTAL, CIRCUMFERENTIAL, ORANGE AND WHITE 6" WIDE, USING A REFLECTIVE MATERIAL HAVING A SMOOTH, SEALED OUTER SURFACE (TYPE IV REFLECTORIZED SHEETING).

THE WEST VIRGINIA
 DIVISION OF HIGHWAYS
 BARRICADES AND CHANNELIZING DEVICES
 FOR
 CONSTRUCTION AND MAINTENANCE OPERATIONS
 FIGURE 8 - DETAIL "A"

PORTABLE AND TEMPORARY MOUNTING



MOUNTING ON TYPE III BARRICADES



LOCATION OF WARNING SIGN



LOCATION OF REGULATORY AND GUIDE SIGNS
(SEE NOTES 1 AND 2)

FIXED SUPPORTS

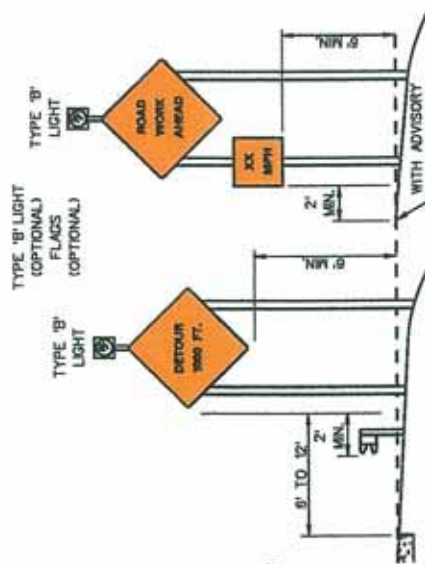

ROADSIDE SIGN
RURAL DISTRICT

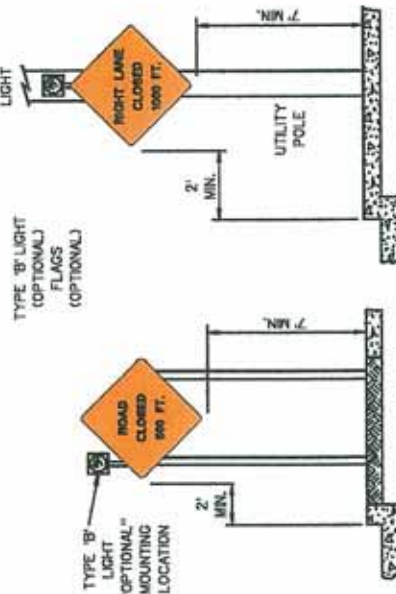

ROADSIDE SIGN
URBAN DISTRICT

HEIGHT AND LATERAL LOCATION OF SIGNS - TYPICAL INSTALLATIONS

GENERAL NOTES:

1. SIGNS MOUNTED ON BARRICADES OR PORTABLE SUPPORTS MAY BE AT LOWER HEIGHTS BUT THE BOTTOM OF THE SIGN SHALL NOT BE LESS THAN 12" ABOVE THE PAVEMENT. WHEN PARKING IS PERMITTED WITHIN 200' OF THE SIGN, ALL SIGNS SHALL BE MOUNTED AT A MINIMUM OF 7 FEET.
2. SIGNS MOUNTED ON TYPE III BARRICADES SHOULD NOT COVER MORE THAN 50 PERCENT OF THE TOP TWO RAILS OR 33 PERCENT OF THE TOTAL AREA OF THE THREE RAILS.
3. ALL SUPPORTS FOR SIGNING SHALL BE CRASHWORTHY. TWO POUND U-CHANNEL, THREE POUND U-CHANNEL OR 4" X 4" MAX. WOOD POSTS MAY BE USED.
4. IF USED TYPE 'B' LIGHTS SHALL BE MOUNTED IN SUCH A MANNER THAT NO PART OF THE LAMP ASSEMBLY OR BATTERY BOX WILL COVER THE SIGN FACE.

THE WEST VIRGINIA
DIVISION OF HIGHWAYS
SIGN MOUNTING
FOR
CONSTRUCTION AND MAINTENANCE OPERATIONS
FIGURE 9 - DETAIL "B"

BARRIER PLACEMENT

NOTE: THIS DETAIL SHOWS REQUIRED OFFSETS FROM BACK OF BARRIER TO CONSTRUCTION LIMITS.

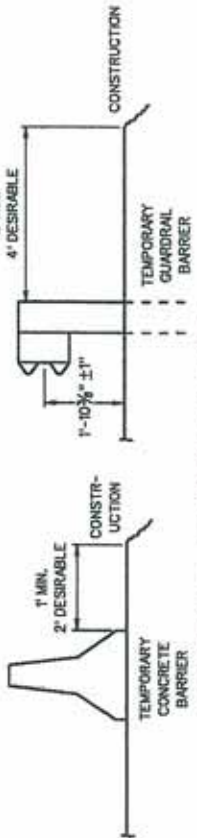

BARRIER CONNECTIONS



PLAN



ELEVATION

ATTACHMENT OF TEMPORARY GUARDRAIL BARRIER TO PERMANENT OR TEMPORARY CONCRETE BARRIER, PARAPET, OR OTHER FIXED OBJECT OR TEMPORARY CONCRETE BARRIER TO EXISTING GUARDRAIL (ALSO SEE GR 9).

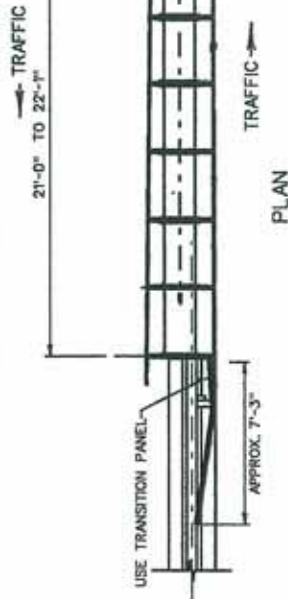

TRANSITION PANEL ASSEMBLY



ELEVATION

- NOTES:
- ATTACH UNIT TO 6" MIN. REINFORCED PORTLAND & CEMENT CONCRETE PAD OR DECK STRUCTURE AS RECOMMENDED BY MANUFACTURER. THREADED RODS MAY BE USED ON 3" MIN. ASPHALTIC SURFACES THAT HAVE A PREPARED COMPACTED SUB-BASE. (AS RECOMMENDED BY MANUFACTURER).

TEMPORARY IMPACT ATTENUATOR
(BACKUP PER MANUFACTURER'S RECOMMENDATIONS)

BARRIER END PROTECTION

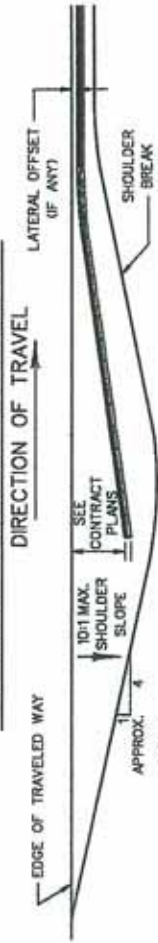

- NOTES:
- THIS DETAIL IS CONCEPTUAL. ACTUAL DIMENSIONS OF FLARE RATE, OFFSET, AND/OR CLEAR ZONE WILL BE SHOWN IN THE PLANS. IF THEY ARE NOT IN THE PLANS, CONTACT TRAFFIC ENGINEERING DIVISION, TO DETERMINE THE FLARE RATE, OFFSET, AND/OR CLEAR ZONE.
 - IF THE FLARE RATE OR CLEAR ZONE CANNOT BE MAINTAINED, AN IMPACT ATTENUATOR SHALL BE USED. (CONTACT TRAFFIC ENGINEERING DIVISION FOR DETAILS).
 - GUARDRAIL TREATMENT WITH A F.E.T. OR T.E.T. AS SHOWN IN STANDARD DETAILS GR 5 AND GR 6 MAY BE SUBSTITUTED FOR FLARE AND/OR IMPACT ATTENUATOR IF APPROVED BY THE ENGINEER.
 - DRAINAGE MAY BE MAINTAINED THROUGH SHOULDER TREATMENT BY USING TEMPORARY PPE.

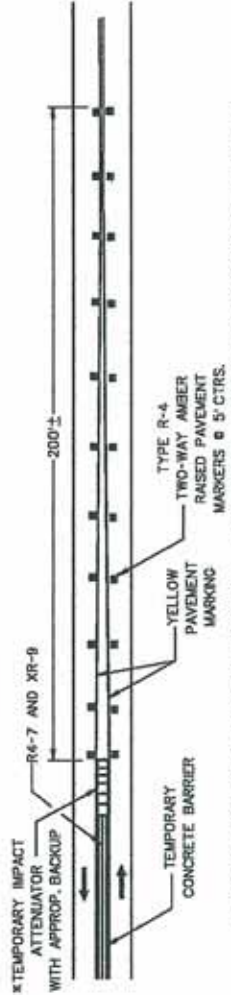

TREATMENT FOR SEPERATION OF TWO-LANE, TWO-WAY OPPOSING TRAFFIC (WITH TEMPORARY CONCRETE BARRIER)



TREATMENT FOR SEPERATION OF TRAFFIC FROM WORK AREA TO BE USED (WHEN FLARE CANNOT BE UTILIZED)

* FOR DETAILS CONTACT TRAFFIC ENGINEERING DIVISION (OTHERWISE, 2'-0" WIDE, BIDIRECTIONAL).

- NOTES:
- SEE GR STANDARDS (VOLUME II) FOR DETAILS WHICH ARE NOT COVERED IN THIS DETAIL.
 - TEMPORARY CONCRETE BARRIER ADJOINING A BRIDGE PARAPET OR OTHER ESSENTIALLY NON-YIELDING BARRIER OR OBSTACLE SHALL BE PLACED IN A MANNER TO MAINTAIN BARRIER CONTINUITY AND PREVENT VEHICLE SNAGGING DURING IMPACT. A CONNECTING DEVICE SHALL BE USED TO MAINTAIN CONTINUITY IF THEY CANNOT BE JOINED IN THIS MANNER (SEE CONTRACT PLANS).

THE WEST VIRGINIA
DIVISION OF HIGHWAYS
TEMPORARY CONCRETE AND GUARDRAIL
BARRIER PLACEMENT, CONNECTION AND
END PROTECTION DETAILS
FIGURE 10 - DETAIL "C"

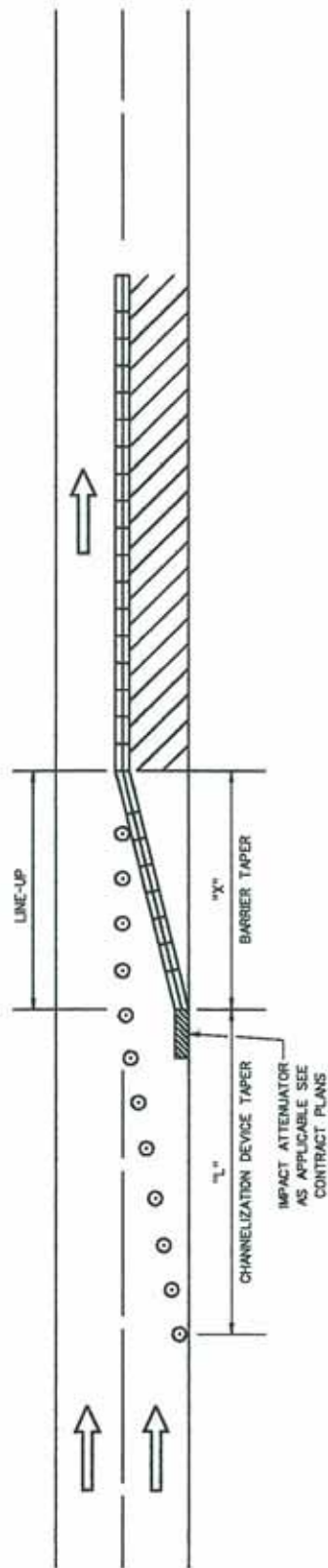

NOTE:

1. FULL LANE CLOSURE SHALL BE MADE PRIOR TO BEGINNING OF BARRIER TAPER.
2. "X" = FLARE RATE X OFFSET

CLOSURE OF ONE TRAFFIC LANE
USING TEMPORARY CONCRETE BARRIER

THE WEST VIRGINIA
DIVISION OF HIGHWAYS
ONE LANE CLOSURE USING POSITIVE BARRIER
FIGURE 11 - DETAIL "D"

Standard:

Warning lights shall flash when placed on channelizing devices used alone or in a cluster to warn of a condition. Warning lights placed on channelizing devices used in a series to channelize road users shall be steady-burn.

The retroreflective material used on channelizing devices shall have a smooth, sealed outer surface that will display a similar color day or night.

Option:

The name and telephone number of the highway agency, contractor, or supplier may be shown on the nonretroreflective surface of all types of channelizing devices.

Standard:

The letters and numbers of the name and telephone number shall be nonretroreflective and not over 2 in. in height.

Guidance:

Particular attention should be given to maintaining the channelizing devices to keep them clean, visible, and properly positioned at all times.

Standard:

Devices that are damaged or have lost a significant amount of their retroreflectivity and effectiveness shall be replaced.

Section F.59 Cones

Standard:

Cones (see Figure 8-Detail "A") shall be predominantly orange and shall be made of a material that can be struck without causing damage to the impacting vehicle. For daytime and low-speed roadways, cones shall be not less than 18 in. in height. When cones are used on freeways and other high-speed highways or at night on all highways, or when more conspicuous guidance is needed, cones shall be a minimum of 28 in. in height.

For nighttime use, cones shall be retroreflectorized or equipped with lighting devices for maximum visibility. Retroreflectorization of cones that are 28 to 36 in. in height shall be provided by a 6 in. wide white band located 3 to 4 in. from the top of the cone and an additional 4 in. wide white band located approximately 2 in. below the 6 in. band.

Retroreflectorization of cones that are more than 36 in. in height shall be provided by horizontal, circumferential, alternating orange and white retroreflective stripes that are 4 to 6 in. wide. Each cone shall have a minimum of two orange and two white stripes with the top stripe being orange. Any nonretroreflective spaces between the orange and white stripes shall not exceed 3 in. in width.

Option:

Traffic cones may be used to channelize road users, divide opposing vehicular traffic lanes, divide lanes when two or more lanes are kept open in the same direction, and delineate short duration maintenance and utility work.

Guidance:

Steps should be taken to minimize the possibility of cones being blown over or displaced by wind or moving vehicular traffic.

Cones should not be used for pedestrian channelization or as pedestrian barriers in temporary traffic control zones on or along sidewalks unless they are continuous between individual devices and detectable to users of long canes.

Option:

Cones may be doubled up to increase their weight.

Support:

Some cones are constructed with bases that can be filled with ballast. Others have specially weighted bases, or weight such as sandbag rings that can be dropped over the cones and onto the base to provide added stability.

Guidance:

Ballast should be kept to the minimum amount needed.

Section F.60 Tubular Markers

Standard:

Tubular markers (see Figure 8-Detail "A") shall be predominantly orange and shall be not less than 18 in. high and 2 in. wide facing road users. They shall be made of a material that can be struck without causing damage to the impacting vehicle.

Tubular markers shall be a minimum of 28 in. in height when they are used on freeways and other high-speed highways, on all highways during nighttime, or whenever more conspicuous guidance is needed.

For nighttime use, tubular markers shall be retroreflectorized. Retroreflectorization of 28 in. or larger tubular markers shall be provided by two 3 in. wide white bands placed a maximum of 2 in. from the top with a maximum of 6 in. between the bands.

Guidance:

Tubular markers should not be used for pedestrian channelization or as pedestrian barriers in temporary traffic control zones on or along sidewalks unless they are continuous between individual devices and detectable to users of long canes.

Tubular markers have less visible area than other devices and should be used only where space restrictions do not allow for the use of other more visible devices.

Tubular markers should be stabilized by affixing them to the pavement, by using weighted bases, or weights such as sandbag rings that can be dropped over the tubular markers and onto the base to provide added stability. Ballast should be kept to the minimum amount needed.

Option:

Tubular markers may be used effectively to divide opposing lanes of road users, divide vehicular traffic lanes when two or more lanes are kept open in the same direction, and to delineate the edge of a pavement drop off where space limitations do not allow the use of larger devices.

Standard:

When a noncylindrical tubular marker is used, it shall be attached to the pavement to ensure that the width facing road users meets the minimum requirements.

A tubular marker shall be attached to the pavement to display the minimum 2 in. width to the approaching road users.

Section F.61 Vertical Panels

Standard:

Vertical panels (see Figure 8-Detail "A") shall be 8 to 12 in. in width and at least 24 in. in height. They shall have orange and white diagonal stripes and be retroreflectorized.

Vertical panels shall be mounted with the top a minimum of 36 in. above the roadway.

Where the height of the vertical panel itself is 36 in. or greater, a panel stripe width of 6 in. shall be used.

Option:

Where the height of the vertical panel itself is less than 36 in., a panel stripe width of 4 in. may be used.

Standard:

Markings for vertical panels shall be alternating orange and white retroreflective stripes, sloping downward at an angle of 45 degrees in the direction vehicular traffic is to pass. Vertical panels used on expressways, freeways, and other high-speed roadways shall have a minimum of 270 square inches retroreflective area facing vehicular traffic.

Option:

Where space is limited, vertical panels may be used to channelize vehicular traffic, divide opposing lanes, or replace barricades.

Section F.62 Drums

Standard:

Drums (see Figure 8-Detail "A") used for road user warning or channelization shall be constructed of lightweight, deformable materials. They shall be a minimum of 36 in. in height and have at least a 18 in. minimum width regardless of orientation. Metal drums shall not be used. The markings on drums shall be horizontal, circumferential, alternating orange and white retroreflective stripes 4 to 6 in. wide. Each drum shall have a minimum of two orange and two white stripes with the top stripe being orange. Any nonretroreflectorized spaces between the horizontal orange and white stripes shall not exceed 3 in. wide. Drums shall have closed tops that will not allow collection of construction debris or other debris.

Support:

Drums are highly visible, have good target value, give the appearance of being formidable obstacles and, therefore, command the respect of road users. They are portable enough to be shifted from place to place within a temporary traffic control zone in order to accommodate changing conditions, but are generally used in situations where they will remain in place for a prolonged period of time.

Option:

Although drums are most commonly used to channelize or delineate road user flow, they may also be used alone or in groups to mark specific locations.

Guidance:

Drums should not be used for pedestrian channelization or as pedestrian barriers in temporary traffic control zones on or along sidewalks unless they are continuous between individual devices and detectable to users of long canes.

Drums should not be weighted with sand, water, or any material to the extent that would make them hazardous to road users or workers when struck. Drums used in regions susceptible to freezing should have drain holes in the bottom so that water will not accumulate and freeze causing a hazard if struck by a road user.

Standard:

Ballast shall not be placed on the top of a drum.

Section F.63 Type I, II, or III Barricades

Support:

A barricade is a portable or fixed device having from one to three rails with appropriate markings and is used to control road users by closing, restricting, or delineating all or a portion of the right-of-way.

As shown in Figure 8-Detail "A", barricades are classified as either Type I, Type II, or Type III.

Standard:

Stripes on barricade rails shall be alternating orange and white retroreflective stripes sloping downward at an angle of 45 degrees in the direction road users are to pass. Except as noted in the Option, the stripes shall be 6 in. wide.

Option:

When rail lengths are less than 36 in., 4 in. wide stripes may be used.

Standard:

The minimum length for Type I and Type II Barricades shall be 24 in., and the minimum length for Type III Barricades shall be 48 in. Each barricade rail shall be 8 to 12 in. wide. Barricades used on expressways, freeways and other high-speed roadways shall have a minimum of 270 square inches of retroreflective area facing road users.

Guidance:

Where barricades extend entirely across a roadway, the stripes should slope downward in the direction toward which road users must turn.

Where both right and left turns are provided, the barricade stripes should slope downward in both directions from the center of the barricade or barricades.

Where no turns are intended, the stripes should be positioned to slope downward toward the center of the barricade or barricades.

Barricade rails should be supported in a manner that will allow them to be seen by the road user, and in a manner that provides a stable support that is not easily blown over or displaced.

The width of the existing pedestrian facility should be provided for the temporary facility if practical. Traffic control devices and other construction materials and features should not intrude into the usable width of the sidewalk, temporary pathway, or other pedestrian facility. When it is not possible to maintain a minimum width of 60 inches throughout the entire length of the pedestrian pathway, a 60 x 60 inch passing space should be provided at least every 200 feet to allow individuals in wheelchairs to pass.

Barricade rail supports should not project into pedestrian circulation routes more than 4 inches from the support between 27 inches and 80 inches from the surface as described in Section 4.4.1 of the "Americans with Disabilities Act Accessibility Guidelines for Buildings and Facilities (ADAAG)."

Option:

For Type I Barricades, the support may include other unstriped horizontal panels necessary to provide stability.

Guidance:

Barricades should be crashworthy as they are located adjacent to vehicular traffic flow and are subject to impact by errant vehicles.

On high-speed expressways or in other situations where barricades may be susceptible to overturning in the wind, ballasting should be used.

Option:

Sandbags may be placed on the lower parts of the frame or the stays of barricades to provide the required ballast.

Standard:

Ballast shall not be placed on top of any striped rail. Barricades shall not be ballasted by nondeformable objects such as rocks or chunks of concrete. Ballast shall not extend into the accessible passage width of 60 in.

Support:

Type I or Type II Barricades are intended for use in situations where road user flow is maintained through the temporary traffic control zone.

Option:

Barricades may be used alone or in groups to mark a specific condition or they may be used in a series for channelizing road users.

Type I Barricades may be used on conventional roads or urban streets.

Guidance:

Type II or Type III Barricades should be used on expressways and freeways or other high-speed roadways. Type III Barricades should be used to close or partially close a road.

Option:

Type III Barricades used at a road closure may be placed completely across a roadway or from curb to curb.

Guidance:

Where provision is made for access of authorized equipment and vehicles, the responsibility for Type III Barricades should be assigned to a person to ensure proper closure at the end of each work day.

Support:

When a highway is legally closed but access must still be allowed for local road users, barricades usually are not extended completely across the roadway.

Standard:

A sign (see Section F.09) shall be installed with the appropriate legend concerning permissible use by local road users. Adequate visibility of the barricades from both directions shall be provided.

Option:

Signs may be installed on barricades (see Section F.03).

Section F.64 Intentionally Left Blank

Section F.65 Temporary Traffic Barriers as Channelizing Devices

Support:

Temporary traffic barriers are not temporary traffic control devices in themselves; however, when placed in a position identical to a line of channelizing devices and marked and/or equipped with appropriate channelization features to provide guidance and warning both day and night, they serve as temporary traffic control devices.

Standard:

Temporary traffic barriers serving as temporary traffic control devices shall conform to requirements for such devices as set forth throughout this Manual.

Temporary traffic barriers shall not be used solely to channelize road users, but also to protect the work space. If used to channelize vehicular traffic, the temporary traffic barrier shall be supplemented with delineation, pavement marking or channelizing devices for improved daytime and nighttime visibility.

Guidance:

Temporary traffic barriers should not be used for a merging taper except in low-speed urban areas. Temporary traffic barriers should not be used for a constricted/restricted temporary traffic control zone.

When it is necessary to use a temporary traffic barrier for a merging taper in low-speed urban areas or for a constricted/restricted temporary traffic control zone, the taper shall be delineated and the taper length should be designed to optimize road user operations considering the available geometric conditions.

When used for channelization, temporary traffic barriers should be of a light color for increased visibility.

Section F.66 Longitudinal Channelizing Barricades

Support:

Longitudinal channelizing barricades are lightweight, deformable channelizing devices that can be used singly as Type I, II, or III barricades, or connected so they are highly visible and have good target value.

Guidance:

When used as a barricade, longitudinal channelizing barricades should conform to the general size, color, stripe pattern, retroreflectivity, and placement characteristics established for the devices described in Chapter F.

Option:

Longitudinal channelizing barricades may be used instead of a line of cones, drums, or barricades.

Longitudinal channelizing barricades may be hollow and filled with water as a ballast.

Guidance:

If used, longitudinal channelizing barricades should be interlocked to delineate or channelize flow including pedestrian traffic control. The interlocking barricade wall should not have gaps that allow pedestrians or vehicles to stray from the channelizing path.

Support:

Longitudinal channelizing barricades are often located adjacent to traffic and therefore are subject to impact by errant vehicles.

Guidance:

Because of their vulnerable position, longitudinal channelizing barricades should be constructed of lightweight materials and be crashworthy.

Although longitudinal channelizing barricades might give the appearance of being formidable obstacles, they have not met the crashworthy requirements for temporary traffic barriers and, therefore, should not be used to shield pedestrians, including workers, from vehicle impacts or obstacles.

Option:

Longitudinal channelizing barricades may be used to channelize pedestrians.

Section F.67 Other Channelizing Devices

Option:

Channelizing devices other than those described in this Manual may be used in special situations based on an engineering study.

Guidance:

Other channelizing devices should conform to the general size, color, stripe pattern, retroreflection, and placement characteristics established for the devices described in this Chapter.

Section F.68 Detectable Edging for Pedestrians

Support:

Individual channelizing devices, tape or rope used to connect individual devices, other discontinuous barriers and devices, and pavement markings are not detectable by persons with visual disabilities and are incapable of providing detectable path guidance on temporary or realigned sidewalks or other pedestrian facilities.

Guidance:

When it is determined that a facility should be accessible to and detectable by pedestrians with visual disabilities, a continuously detectable edging should be provided throughout the length of the facility such that it can be followed by pedestrians using long canes for guidance. This edging should protrude at least 6 in. above the surface of the sidewalk or pathway, with the bottom of the edging a maximum of 2.5 in above the surface. This edging should be continuous throughout the length of the facility except for gaps at locations where pedestrians or vehicles will be turning or crossing. This edging

should consist of prefabricated or formed-in place curbing or other continuous device that is placed along the edge of the sidewalk or walkway. This edging should be firmly attached to the ground or to other devices. Adjacent sections of this edging should be interconnected such that the edging is not displaced by pedestrian or vehicular traffic or work operations, and such that it does not constitute a hazard to pedestrians, workers, or other road users.

Support:

Examples of detectable edging for pedestrians include:

- A. Prefabricated lightweight sections of plastic, metal, or other suitable materials that are interconnected and fixed in place to form a continuous edge.
- B. Prefabricated lightweight sections of plastic, metal, or other suitable materials that are interconnected, fixed in place, and placed at ground level to provide a continuous connection between channelizing devices located at intervals along the edge of the sidewalk or walkway.
- C. Sections of lumber interconnected and fixed in place to form a continuous edge.
- D. Formed-in-place asphalt or concrete curb.
- E. Prefabricated concrete curb sections that are interconnected and fixed in place to form a continuous edge.
- F. Continuous temporary traffic barrier or longitudinal channelizing barricades placed along the edge of the sidewalk or walkway that provides a pedestrian edging at ground level.
- G. Chain link or other fencing equipped with a continuous bottom rail.

Guidance:

Detectable pedestrian edging should be orange, white, or yellow and should match the color of the adjacent channelizing devices or traffic control devices, if any are present.

Section F.69 Temporary Raised Islands

Standard:

Temporary raised islands shall be used only in combination with pavement striping and other suitable channelizing devices.

Option:

A temporary raised island may be used to separate vehicular traffic flows in two-lane, two-way operations on roadways having a vehicular traffic volume range of 4,000 to 15,000 average daily traffic (ADT) and on freeways having a vehicular traffic volume range of 22,000 ADT to 60,000 ADT.

Temporary raised islands also may be used in other than two-lane, two-way operations where physical separation of vehicular traffic from the temporary traffic control zone is not required.

Guidance:

Temporary raised islands should have the basic dimensions of 4 in. high by at least 18 in. wide and have rounded or chamfered corners.

The temporary raised islands should not be designed in such a manner that they would cause a motorist to lose control of the vehicle if the vehicle inadvertently strikes the temporary raised island. If struck, pieces of the island should not be dislodged to the extent that they could penetrate the occupant compartment or involve other vehicles.

Standard:

At pedestrian crossing locations, temporary raised islands shall have an opening or be shortened to provide at least a 60 in. wide pathway for the crossing pedestrian.

Section F.70 Opposing Traffic Lane Divider

Support:

Opposing traffic lane dividers are delineation devices used as center lane dividers to separate opposing vehicular traffic on a two-lane, two-way operation.

Standard:

Opposing traffic lane dividers shall not be placed across pedestrian crossings.

The Opposing Traffic Lane Divider (W6-4) sign is an upright, retroreflective orange-colored sign placed on a flexible support and sized at least 12 in. wide by 18 in. high.

Section F.71 Pavement Markings

Standard:

The provisions of this Section shall not be considered applicable for short-term, mobile, or incident management temporary traffic control zones.

Pavement markings shall be maintained along paved streets and highways in all long- and intermediate-term stationary (see Section G.02) temporary traffic control zones. All pavement markings shall be in accordance with Chapters 3A and 3B of the "Manual on Uniform Traffic Control Devices", except as indicated in Section F.72. Pavement markings shall match the markings in place at both ends of the temporary traffic control zone. Pavement markings shall be placed along the entire length of any surfaced detour or temporary roadway prior to the detour or roadway being opened to road users.

Warning signs, channelizing devices, and delineation shall be used to indicate required road user paths in temporary traffic control zones where it is not possible

to provide a clear path by pavement markings. All pavement markings and devices used to delineate road user paths shall be carefully reviewed during daytime and nighttime periods.

For long-term stationary operations, pavement markings in the temporary traveled way that are no longer applicable shall be removed or obliterated as soon as practical. Pavement marking obliteration shall leave a minimum of pavement scars and shall remove old marking material. Painting over existing pavement markings with black paint or spraying with asphalt shall not be accepted as a substitute for removal or obliteration.

Guidance:

Road users should be provided pavement markings within a temporary traffic control zone comparable to the pavement markings normally maintained along such roadways, particularly at either end of the temporary traffic control zone.

The intended vehicle path should be defined in day, night, and twilight periods under both wet and dry pavement conditions.

The work should be planned and staged to provide for the placement and removal of the pavement markings.

Markings should be provided in intermediate-term, stationary work zones.

Option:

Removable, nonreflective, preformed tape may be used where markings need to be covered temporarily.

Section F.72 Temporary Pavement Markings

Support:

Temporary pavement markings are those that are allowed to remain in place until the earliest date when it is practical and possible to install pavement markings that meet the Part 3 of the "Manual on Uniform Traffic Control Devices" standards for pavement markings.

Guidance:

Temporary pavement markings should normally not be in place for more than 2 weeks unless justified by an engineering study.

Standard:

All temporary pavement markings, including pavement markings for no-passing zones, shall conform to the requirements of Chapters 3A and 3B of the "Manual on Uniform Traffic Control Devices." All temporary broken-line pavement markings shall use the same cycle length as permanent markings and be at least 2 ft long.

Option:

Half-cycle lengths with a minimum of 2 ft stripes may be used on roadways with severe curvature for centerlines in passing zones and for lane lines.

For temporary situations of 3 calendar days or less, for a two- or three-lane road, no-passing zones may be identified by using DO NOT PASS (R4-1), PASS WITH CARE (R4-2), and NO PASSING ZONE (W14-3) signs rather than pavement markings. Also, DO NOT PASS, PASS WITH CARE, and NO PASSING ZONE signs may be used instead of pavement markings on roads with low volumes for longer periods in accordance with the Division of Highways policy.

Guidance:

If used, the DO NOT PASS, PASS WITH CARE, and NO PASSING ZONE signs should be placed in accordance with Sections 2B.29, 2B.30, and 2C.35 of the "Manual on Uniform Traffic Control Devices."

The temporary use of edge lines, channelizing lines, lane reduction transitions, gore markings, and other longitudinal markings, and the various nonlongitudinal markings (such as stop lines, railroad crossings, crosswalks, words or symbols) should be in accordance with the Division of Highways policy.

Section F.73 Raised Pavement Markers

Standard:

If raised pavement markers are used to substitute for broken line segments, at least two retroreflective markers shall be placed, one at each end of a segment of 2 ft. to 5 ft. in length. For segments longer than 5 ft., a group of at least three retroreflective markers shall be equally spaced at no greater than $N/8$ (see Section 3B.11 of the "Manual on Uniform Traffic Control Devices"). The value of N for a broken or dotted line shall equal the length of one line segment plus one gap. The value of N referenced for solid lines shall equal the N for the broken or dotted lines that might be adjacent to or may extend the solid lines (see Chapter 3B of the "Manual on Uniform Traffic Control Devices").

Guidance:

Raised pavement markers should be considered for use along surfaced detours or temporary roadways, and other changed or new travel-lane alignments.

Option:

Retroreflective or internally illuminated raised pavement markers, or nonretroreflective raised pavement markers supplemented by retroreflective or internally illuminated markers, may replace or supplement markings prescribed in Chapters 3A and 3B of the "Manual on Uniform Traffic Control Devices."

Section F.74 Delineators

Standard:

When used, delineators shall combine with or supplement other temporary traffic control devices. They shall be mounted on crashworthy supports so that the reflecting unit is approximately 4 ft. above the near roadway edge. The standard color for delineators used along both sides of two-way streets and highways and the right side of one-way roadways shall be white. Delineators used along the left side of one-way roadways shall be yellow.

Guidance:

Spacing along roadway curves should be as set forth in the Standard Details and should be such that several delineators are always visible to the driver.

Option:

Delineators may be used in temporary traffic control zones to indicate the alignment of the roadway and to outline the required vehicle path through the temporary traffic control zone.

Section F.75 Lighting Devices

Guidance:

Lighting devices should be provided in temporary traffic control zones based on engineering judgment.

When used to supplement channelization, the maximum spacing for warning lights should be identical to the channelizing device spacing requirements.

Support:

Four types of lighting devices are commonly used in temporary traffic control zones. They are floodlights, flashing warning beacons, warning lights, and steady-burn electric lamps.

Option:

Lighting devices may be used to supplement retroreflectorized signs, barriers, and channelizing devices.

During normal daytime maintenance operations, the functions of flashing warning beacons may be provided by high intensity rotating, flashing, oscillating, or strobe lights on a maintenance vehicle.

Standard:

Although vehicle hazard warning lights are permitted to be used to supplement high-intensity rotating, flashing, oscillating, or strobe lights, they shall not be used instead of high intensity rotating, flashing, oscillating, or strobe lights.

Section F.76 Floodlights

Support:

Utility, maintenance, or construction activities on highways are frequently conducted during nighttime periods when vehicular traffic volumes are lower. Large construction projects are sometimes operated on a double-shift basis requiring night work.

Guidance:

When nighttime work is being performed, floodlights should be used to illuminate the work area, flagger stations, equipment crossings, and other areas.

Standard:

Except in emergency situations, flagger stations shall be illuminated at night.

Floodlighting shall not produce a disabling glare condition for approaching road users, flaggers, or workers.

Guidance:

The adequacy of the floodlight placement and elimination of potential glare should be determined by driving through and observing the floodlighted area from each direction on all approaching roadways after the initial floodlight setup, at night, and periodically.

Support:

Desired illumination levels vary depending upon the nature of the task involved. An average horizontal luminance of 50 lux (5 foot candles) can be adequate for general activities. Tasks requiring high levels of precision and extreme care can require an average horizontal luminance of 216 lux (20 foot candles).

Section F.77 Flashing Warning Beacons

Support:

Flashing warning beacons are often used to supplement a temporary traffic control device.

Standard:

Flashing warning beacons shall comply with the provisions of Chapter 4K of the "Manual on Uniform Traffic Control Devices." A flashing warning beacon shall be a flashing yellow light with a minimum nominal diameter of 8 in.

Guidance:

Flashing warning beacons should be operated 24 hours per day.

Support:

The temporary terminus of a freeway is an example of a location where flashing warning beacons alert drivers to the changing roadway conditions and the need to reduce speed in transitioning from the freeway to another roadway type.

Section F.78 Warning Lights

Support:

Type A, Type B, and Type C and Type D 360-degree warning lights are portable, powered, yellow, lens-directed, enclosed lights.

Standard:

Warning lights shall be in accordance with the current Division of Highways Specifications and NCHRP-350.

When warning lights are used, they shall be mounted on signs or channelizing devices in a manner that, if hit by an errant vehicle, they will not be likely to penetrate the windshield.

Guidance:

The maximum spacing for warning lights should be identical to the channelizing device spacing requirements.

Support:

The light weight and portability of warning lights are advantages that make these devices useful as supplements to the retroreflectorization on signs and channelizing devices. The flashing lights are effective in attracting road users' attention.

Option:

Warning lights may be used in either a steady-burn or flashing mode.

Standard:

Flashing warning lights shall not be used for delineation, as a series of flashers fails to identify the desired vehicle path.

Type A Low-Intensity Flashing warning lights, Type C Steady-Burn warning lights and Type D 360-degree Steady-Burn warning lights shall be maintained so as to be capable of being visible on a clear night from a distance of 3,000 ft. Type B High-Intensity Flashing warning lights shall be maintained so as to be capable of being visible on a sunny day when viewed without the sun directly on or behind the device from a distance of 1,000 ft.

Warning lights shall have a minimum mounting height of 30 in. to the bottom of the lens.

Support:

Type A Low-Intensity Flashing warning lights are used to warn road users during nighttime hours that they are approaching or proceeding in a potentially hazardous area.

Option:

Type A warning lights may be mounted on channelizing devices.

Support:

Type B High-Intensity Flashing warning lights are used to warn road users during both daylight and nighttime hours that they are approaching a potentially hazardous area.

Option:

Type B warning lights are designed to operate 24 hours per day and may be mounted on advance warning signs or on independent supports.

Type C Steady-Burn warning lights and Type D 360-degree Steady-Burn warning lights may be used during nighttime hours to delineate the edge of the traveled way.

Guidance:

When used to delineate a curve, Type C and Type D 360-degree warning lights should only be used on devices on the outside of the curve, and not on the inside of the curve.

Section F.79 Steady-Burn Electric Lamps

Support:

Steady-Burn electric lamps are a series of low-wattage, yellow, electric lamps, generally hard-wired to a 110-volt external power source.

Steady-Burn electric lamps may be used in place of Type C Steady-Burn Warning Lights.

Section F.80 Temporary Traffic Control Signals

Standard:

Temporary traffic control signals used to control road user movements through temporary traffic control zones and in other temporary traffic control situations shall meet the applicable provisions of Part 4 of the "Manual on Uniform Traffic Control Devices."

Support:

Temporary traffic control signals are typically used in temporary traffic control zones such as temporary haul road crossings; temporary one-way operations along a one-lane, two-way highway; temporary one-way operations on bridges, reversible lanes, and intersections.

Standard:

One-lane, two-way vehicular traffic flow requires an all-red interval of sufficient duration for road users to clear the portion of the temporary traffic control zone controlled by the traffic control signals. Safeguards shall be incorporated to avoid the possibility of conflicting signal indications at each end of the temporary traffic control zone.

Guidance:

Where pedestrian traffic is detoured to a temporary traffic control signal, engineering judgment should be used to determine if pedestrian signals or accessible pedestrian signals (see Section 4E.06 of the "Manual on Uniform Traffic Control Devices") are needed for crossing along an alternate route.

When temporary traffic control signals are used, conflict monitors typical of traditional traffic control signal operations should be used.

Option:

Temporary traffic control signals may be portable or temporarily mounted on fixed supports.

Standard:

The supports for temporary traffic control signals shall not encroach into the minimum required width of a "pedestrian access route" of 48 inches or an "adequate circulation path" of 36 inches.

Guidance:

Temporary traffic control signals should only be used in situations where temporary traffic control signals are preferable to other means of traffic control, such as changing the work staging or work zone size to eliminate one-way vehicular traffic movements, using flaggers to control one-way or crossing movements, using STOP or YIELD signs, and using warning devices alone.

Support:

Factors related to the design and application of temporary traffic control signals include the following:

- A. Safety and road user needs;
- B. Work staging and operations;
- C. The feasibility of using other temporary traffic control strategies (for example, flaggers, providing space for two lanes, or detouring road users, including bicyclists and pedestrians);
- D. Sight distance restrictions;

- E. Human factors considerations (for example, lack of driver familiarity with temporary traffic control signals);
- F. Road-user volumes including roadway and intersection capacity;
- G. Affected side streets and driveways;
- H. Vehicle speeds;
- I. The placement of other temporary traffic control devices;
- J. Parking;
- K. Turning restrictions;
- L. Pedestrians;
- M. The nature of adjacent land use (such as residential or commercial);
- N. Legal authority;
- O. Signal phasing and timing requirements;
- P. Full-time or part-time operation;
- Q. Actuated, fixed-time, or manual operation;
- R. Power failures or other emergencies;
- S. Inspection and maintenance needs;
- T. Need for detailed placement, timing, and operation records; and
- U. Operation by contractors or by others.

Although temporary traffic control signals can be mounted on trailers or lightweight portable supports, fixed supports offer superior resistance to displacement or damage by severe weather, vehicle impact, and vandalism.

Guidance:

Other temporary traffic control devices should be used to supplement temporary traffic control signals, including warning and regulatory signs, pavement markings, and channelizing devices.

The design and placement of temporary traffic control signals should include interconnection to other traffic control signals along the subject roadway.

Temporary traffic control signals not in use should be covered or removed.

Section F.81 Temporary Traffic Barriers

Support:

Temporary traffic barriers are devices designed to help prevent penetration by vehicles while minimizing injuries to vehicle occupants, and are designed to protect workers, bicyclists, and pedestrians.

The four primary functions of temporary traffic barriers are:

- A. To keep vehicular traffic from entering work areas, such as excavations or material storage sites;
- B. To separate workers, bicyclists, and pedestrians from motor vehicle traffic;
- C. To separate opposing directions of vehicular traffic; and
- D. To separate vehicular traffic, bicyclists, and pedestrians from the work area such as false work for bridges and other exposed objects

Option:

Temporary traffic barriers, including shifting portable or movable barrier installations to accommodate varying directional vehicular traffic demands, may be used to separate two-way motor vehicle traffic.

Guidance:

Because the protective requirements of a temporary traffic control situation have priority in determining the need for temporary traffic barriers, their use should be based on an engineering study. When serving the additional function of channelizing motor vehicle traffic (see Section F.65), temporary traffic barriers should be a light color for increased visibility.

Standard:

Temporary traffic barriers shall be supplemented with standard delineation, pavement markings, or channelizing devices for improved daytime and nighttime visibility if they are used to channelize vehicular traffic. The delineation color shall match the applicable pavement marking color.

In order to mitigate the effect of striking the end of a temporary traffic barrier, the end shall be installed in accordance with AASHTO's "Roadside Design Guide" by flaring until the end is outside the acceptable clear zone or by providing crashworthy end treatments.

Option:

Warning lights or steady-burn electric lamps may be mounted on temporary traffic barrier installations.

Support:

A movable barrier is a linear system of connected barrier segments that can rapidly be shifted laterally by using a specially designed transfer vehicle. The transfer is accomplished in a manner that does not interfere with vehicular traffic in adjacent lanes. Applications of movable barriers include the following:

- A. Closing an additional lane during work periods while maintaining the advantage of having the travel way separated from the work space by a barrier;
- B. Closing an additional lane during off-peak periods to provide extra space for work activities without adversely impacting vehicular traffic flow; and
- C. Creating a temporary reversible lane, thus providing unbalanced capacity favoring the major direction of vehicular traffic flow.

More specific information on the use of temporary traffic barriers is contained in Chapters 8 and 9 of AASHTO's "Roadside Design Guide" (see Section 1A.11 of the "Manual on Uniform Traffic Control Devices").

Section F.82 Crash Cushions (Impact Attenuators)

Support:

Crash cushions are systems that mitigate the effects of errant vehicles that strike obstacles, either by smoothly decelerating the vehicle to a stop when hit head-on, or by redirecting the errant vehicle. The two types of crash cushions that are used in temporary traffic control zones are stationary crash cushions and truck-mounted attenuators. Crash cushions in temporary traffic control zones help protect the drivers from the exposed ends of barriers, fixed objects, shadow vehicles, and other obstacles. Specific information on the use of crash cushions can be found in AASHTO's "Roadside Design Guide" (see Section 1A.11 of the "Manual on Uniform Traffic Control Devices").

Standard:

Crash cushions shall be crashworthy. They shall also be designed for each application to stop or redirect errant vehicles under prescribed conditions. Crash cushions shall be periodically inspected to verify that they have not been hit or damaged. Damaged crash cushions shall be promptly repaired or replaced to maintain their crashworthiness.

Support:

Stationary crash cushions are used in the same manner as permanent highway installations to protect drivers from the exposed ends of barriers, fixed objects, and other obstacles.

Standard:

Stationary crash cushions shall be designed for the specific application intended.

Truck-mounted attenuators shall be energy-absorbing devices attached to the rear of shadow trailers or trucks. If used, the shadow vehicle with the attenuator shall be located in advance of the work area, workers, or equipment to reduce the severity of rear-end crashes from errant vehicles.

Support:

Trucks or trailers are often used as shadow vehicles to protect workers or work equipment from errant vehicles. These shadow vehicles are sometimes equipped with flashing arrows, changeable message signs, and/or high-intensity rotating, flashing, oscillating, or strobe lights located properly in advance of the workers and/or equipment that they are protecting. However, these shadow vehicles might themselves cause injuries to occupants of the errant vehicles if they are not equipped with truck-mounted attenuators.

Guidance:

The shadow truck should be positioned a sufficient distance in advance of the workers or equipment being protected so that there will be sufficient distance, but not so much so that errant vehicles will travel around the shadow truck and strike the protected workers and/or equipment.

Support:

Chapter 9 of AASHTO's "Roadside Design Guide" contains additional information regarding the use of shadow vehicles.

Guidance:

The truck-mounted attenuator should be used in accordance with the manufacturer's specifications.

Section F.83 Vehicle-Arresting Systems

Support:

Vehicle-arresting systems are designed to prevent penetration into activity areas while providing for smooth, safe deceleration for the errant vehicles. They can consist of portable netting, cables, and energy-absorbing anchors.

Guidance:

When used, a vehicle-arresting system should be used in accordance with the manufacturer's specifications, and should be located so that vehicles are not likely to penetrate the location that the system is designed to protect.

Section F.84 Rumble Strips

Support:

Transverse rumble strips consist of intermittent narrow, transverse areas of rough-textured or slightly raised or depressed road surface that extend across the travel lanes to alert drivers to unusual vehicular traffic conditions. Through noise and vibration they attract the driver's attention to such features as unexpected changes in alignment and to conditions requiring a stop.

Longitudinal rumble strips consist of a series of rough-textured or slightly raised or depressed road surfaces located along the shoulder to alert road users that they are leaving the travel lanes.

Standard:

If it is desirable to use a color other than the color of the pavement for a longitudinal rumble strip, the color of the rumble strip shall be the same color as the longitudinal line the rumble strip supplements.

If the color of a transverse rumble strip used within a travel lane is not the color of the pavement, the color of the rumble strip shall be white.

Option:

Intervals between transverse rumble strips may be reduced as the distance to the approached conditions is diminished in order to convey an impression that a closure speed is too fast and/or that an action is imminent. A sign warning drivers of the onset of rumble strips may be placed in advance of any transverse rumble strip installation.

Guidance:

Transverse rumble strips should be placed transverse to vehicular traffic movement. They should not adversely affect overall pavement skid resistance under wet or dry conditions.

In urban areas, even though a closer spacing might be warranted, transverse rumble strips should be designed in a manner that does not promote panic braking or erratic steering maneuvers by drivers.

Transverse rumble strips should not be placed on sharp horizontal or vertical curves.

Rumble strips should not be placed through pedestrian crossings or on bicycle routes.

Transverse rumble strips should not be placed on roadways used by bicyclists unless a minimum clear path of 4 ft. is provided at each edge of the roadway as described in AASHTO's "Guide to the Development of Bicycle Facilities".

Longitudinal rumble strips should not be placed on the shoulder of a roadway that is used by bicyclists unless a minimum clear path of 4 ft. is also provided on the shoulder.

Sections F.85 Screens (Glare Barriers)

Support:

Screens are used to block the road users' view of activities that can be distracting. Screens might improve safety and vehicular traffic flow where volumes approach the roadway capacity because they discourage gawking and reduce headlight glare from oncoming vehicular traffic.

Guidance:

Screens should not be mounted where they could adversely restrict driver visibility and sight distance and adversely affect the safe operation of vehicles.

Option:

Screens may be mounted on the top of temporary traffic barriers that separate two-way vehicular traffic.

Guidance:

Design of screens should be in accordance with Chapter 9 of AASHTO's "Roadside Design Guide" (see Section 1A.11 of the "Manual on Uniform Traffic Control Devices").

CHAPTER G. TYPE OF TEMPORARY TRAFFIC CONTROL ZONE ACTIVITIES

Section G.01 Typical Applications

Standard:

The needs and control of all road users (motorists, bicyclists, and pedestrians within the highway, including persons with disabilities in accordance with the Americans with Disabilities Act of 1990 (ADA), Title II, Paragraph 35.130) through a temporary traffic control zone shall be an essential part of highway construction, utility work, maintenance operations, and the management of traffic incidents.

Support:

Each temporary traffic control zone is different. Many variables, such as location of work, highway type, geometrics, vertical and horizontal alignment, intersections, interchanges, road user volumes, road vehicle mix (buses, trucks, and cars), and road user speeds affect the needs of each zone. The goal of temporary traffic control in work zones is safety with minimum disruption to road users. The key factor in promoting temporary traffic control zone safety is proper judgment.

The Cases of temporary traffic control zones are organized according to duration, location, type of work, and highway type. These Cases include the use of various temporary traffic control methods, but do not include a layout for every conceivable work situation.

Guidance:

The Cases should be altered, when necessary, to fit the conditions of a particular temporary traffic control zone.

Option:

Other devices may be added to supplement the devices shown in Cases, while others may be deleted. The sign spacing and taper lengths may be increased to provide additional time or space for driver response.

Support:

Decisions regarding the selection of the most appropriate Case to use as a guide for a specific temporary traffic control zone require an understanding of each situation. Although there are many ways of categorizing temporary traffic control zone applications, the four factors mentioned earlier (work duration, work location, work type, and highway type) are used to characterize the Cases.

Section G.02 Work Duration

Support:

Chapter D and Sections F.68 and G.05 contain additional information regarding the steps to follow when pedestrian or bicycle facilities affected by the worksite.

Work duration is a major factor in determining the number and types of devices used in temporary traffic control zones. The duration of a temporary traffic control zone is defined relative to the length of time a work operation occupies a spot location.

Standard:

The five categories of work duration and their time at a location shall be:

- A. Long-term stationary is work that occupies a location more than 3 days.**
- B. Intermediate-term stationary is work that occupies a location more than one daylight period up to 3 days, or nighttime work lasting more than 1 hour.**
- C. Short-term stationary is daytime work that occupies a location for more than 1 hour, within a single daylight period.**
- D. Short duration is work that occupies a location up to 1 hour.**
- E. Mobile is work that moves intermittently or continuously.**

Support:

At long-term stationary temporary traffic control zones, there is ample time to install and realize benefits from the full range of temporary traffic control procedures and devices that are available for use. Generally, larger channelizing devices, temporary roadways, and temporary traffic barriers are used.

Standard:

Since long-term operations extend into nighttime, retroreflective and/or illuminated devices shall be used in long-term stationary temporary traffic control zones.

Guidance:

Inappropriate markings in long-term stationary temporary traffic control zones should be removed and replaced with temporary markings.

Support:

In intermediate-term stationary temporary traffic control zones, it might not be feasible or practical to use procedures or devices that would be desirable for long-term stationary temporary traffic control zones, such as altered pavement markings, temporary traffic barriers, and

temporary roadways. The increased time to place and remove these devices in some cases could significantly lengthen the project, thus increasing exposure time. In other instances, there might be insufficient pay-back time to economically justify more elaborate temporary traffic control measures.

Standard:

Since intermediate-term operations extend into nighttime, retroreflective and/or illuminated devices shall be used in intermediate-term stationary temporary traffic control zones.

Support:

Most maintenance and utility operations are short-term stationary work.

As compared to stationary operations, mobile and short-duration operations are activities that might involve different treatments. Devices having greater mobility might be necessary such as signs mounted on trucks. Devices that are larger, more imposing, or more visible can be used effectively and economically. The mobility of the temporary traffic control zone is important.

Maintaining reasonably safe work and road user conditions is a paramount goal in carrying out mobile operations.

Guidance:

Safety in short-duration or mobile operations should not be compromised by using fewer devices simply because the operation will frequently change its location.

Option:

Appropriately colored or marked vehicles with high intensity rotating, flashing, oscillating, or strobe lights may be used in place of signs and channelizing devices for short-duration or mobile operations. These vehicles may be augmented with signs or arrow panels.

Support:

During short-duration work, it often takes longer to set up and remove the temporary traffic control zone than to perform the work. Workers face hazards in setting up and taking down the temporary traffic control zone. Also, since the work time is short, delays affecting road users are significantly increased when additional devices are installed and removed.

Option:

Considering these factors, simplified control procedures may be warranted for short-duration work. A reduction in the number of devices may be offset by the use of other more dominant devices such as high-intensity rotating, flashing, oscillating, or strobe lights on work vehicles.

Support:

Mobile operations often involve frequent short stops for activities such as litter cleanup, pothole patching, or utility operations, and are similar to short-duration operations.

Guidance:

Warning signs, high-intensity rotating, flashing, oscillating, or strobe lights on a vehicle, flags, and/or channelizing devices should be used and moved periodically to keep them near the mobile work area.

Option:

Flaggers may be used for mobile operations that involve short stops.

Support:

Mobile operations also include work activities where workers and equipment move along the road without stopping, usually at slow speeds. The advance warning area moves with the work area.

Guidance:

When mobile operations are being performed, a shadow vehicle equipped with an arrow panel or a sign should follow the work vehicle, especially when vehicular traffic speeds or volumes are high. Where feasible, warning signs should be placed along the roadway and moved periodically as work progresses.

Under high-volume conditions, consideration should be given to scheduling mobile operations work during off-peak hours.

If there are mobile operations on a high-speed travel lane of a multilane divided highway, arrow panels should be used.

Option:

For mobile operations that move at speeds less than 3 mph, mobile signs or stationary signing that is periodically retrieved and repositioned in the advance warning area may be used.

At higher speeds, vehicles may be used as components of the temporary traffic control zones for mobile operations. Appropriately colored and marked vehicles with signs, flags, high-intensity rotating, flashing, oscillating, or strobe lights, truck-mounted attenuators, and arrow panels or portable changeable message signs may follow a train of moving work vehicles.

For some continuously moving operations, such as street sweeping and snow removal, a single work vehicle with appropriate warning devices on the vehicle may be used to provide warning to approaching road users.

Standard:

Mobile operations that move at speeds greater than 20 mph, such as pavement marking operations, shall have appropriate devices on the equipment (that is, high-intensity rotating, flashing, oscillating, or strobe lights, signs, or special lighting), or shall use a separate vehicle with appropriate warning devices.

Section G.03 Location of Work

Support:

Chapter D and Section G.05 contain additional information regarding the steps to follow when pedestrian or bicycle facilities are affected by the worksite.

The choice of temporary traffic control needed for a temporary traffic control zone depends upon where the work is located. As a general rule, the closer the work is to road users (including bicyclists and pedestrians), the greater the number of temporary traffic control devices that are needed. Procedures are described later in this Chapter for establishing temporary traffic control zones in the following locations:

- A. Outside the shoulder;
- B. On the shoulder with no encroachment;
- C. On the shoulder with minor encroachment;
- D. Within the median; and
- E. Within the traveled way.

Standard:

When the work space is within the traveled way, except for short-duration and mobile operations, advance warning shall provide a general message that work is taking place and shall supply information about highway conditions. Temporary traffic control devices shall indicate how vehicular traffic can move through the temporary traffic control zone.

Section G.04 Modifications To Fulfill Special Needs

Support:

Chapter D and Section G.05 contain additional information regarding the steps to follow when pedestrian or bicycle facilities are affected by the worksite.

The Traffic Control Cases illustrate commonly encountered situations in which temporary traffic control devices are employed.

Option:

Other devices may be added to supplement the devices indicated in the Cases, and device spacing may be adjusted to provide additional reaction time. When conditions are less complex than those depicted in the Cases, fewer devices may be needed.

Guidance:

When conditions are more complex, Cases should be modified by giving particular attention to the provisions set forth in Chapter B and by incorporating appropriate devices and practices from the following list:

A. Additional devices:

1. Signs
2. Arrow panels
3. More channelizing devices at closer spacing (with detectable edging for pedestrians).
4. Temporary raised pavement markers
5. High-level warning devices
6. Portable changeable message signs
7. Temporary traffic signals (including pedestrian signals and accessible pedestrian signals).
8. Temporary traffic barriers
9. Crash cushions
10. Screens
11. Rumble strips
12. More delineation

B. Upgrading of devices:

1. A full complement of standard pavement markings
2. Brighter and/or wider pavement markings
3. Larger and/or brighter signs
4. Channelizing devices with greater conspicuity
5. Temporary traffic barriers in place of channelizing devices

C. Improved geometrics at detours or crossovers.

D. Increased distances:

1. Longer advance warning area
2. Longer tapers

E. Lighting:

1. Temporary roadway lighting
2. Steady-burn lights used with channelizing devices
3. Flashing lights for isolated hazards
4. Illuminated signs
5. Floodlights

Where pedestrian or bicycle usage is high, Cases should also be modified by giving particular attention to the provisions set forth in Chapter D and Sections of this manual related to accessibility and detectability provisions in temporary traffic control zones.

Section G.05 Work Affecting Pedestrian and Bicycle Facilities

Support:

It is not uncommon, particularly in urban areas, that road work and the associated temporary traffic control will affect existing pedestrian or bicycle facilities. It is essential that the needs of all road users, including pedestrians with disabilities, are considered in temporary traffic control zones.

In addition to specific provisions identified in Sections G.06, G.07, G.08, G.10, G.11, G.12, and G.13, there are a number of provisions that might be applicable for all of the types of activities identified in this Chapter.

Guidance:

Where pedestrian or bicycle usage is high, the Cases should be modified by giving particular attention to the provisions set forth in Chapters D and G, and in other Sections of this manual related to accessibility and detectability provisions in temporary traffic control zones.

Pedestrians should be separated from the worksite by appropriate devices that maintain the accessibility and detectability for pedestrians with disabilities.

Bicyclists and pedestrians should not be exposed to unprotected excavations, open utility access, overhanging equipment, or other such conditions.

Except for short duration and mobile operations, when a highway shoulder is occupied, a SHOULDER WORK sign should be placed in advance of the activity area. When work is performed on a paved shoulder 8 feet or more in width, channelizing devices should be placed on a taper having a length that conforms to the requirements of a shoulder taper. Signs should be placed such that they do not narrow any existing pedestrian passages to less than 48 inches.

Pedestrian detours should be avoided since pedestrians rarely observe them and the cost of providing accessibility and detectability might outweigh the cost of maintaining a continuous route. Whenever possible, work should be done in a manner that does not create a need to detour pedestrians from existing routes or crossings.

Standard:

Where pedestrian routes are closed, alternate pedestrian routes shall be provided.

When existing pedestrian facilities are disrupted, closed, or relocated in temporary traffic control zone, the temporary facilities shall be detectable and shall include accessibility features consistent with the features present in the existing pedestrian facility.

Section G.06 Work Outside of Shoulder

Support:

Chapter D and Section G.05 contain additional information regarding the steps to follow when pedestrian or bicycle facilities are affected by the worksite.

When work is being performed off the roadway (beyond the shoulders, but within the right-of-way), little or no temporary traffic control might be needed. Temporary traffic control generally is not needed where work is confined to an area 15 ft. or more from the edge of the traveled way. However, temporary traffic control is appropriate where distracting situations exist, such as vehicles parked on the shoulder, vehicles accessing the work site via the highway, and equipment traveling on or crossing the roadway to perform the work operations (for example, mowing). For work beyond the shoulder, see Case A1.

Guidance:

Where the above situations exist, a single warning sign, such as ROAD WORK AHEAD, should be used. If the equipment travels on the roadway, the equipment should be equipped with appropriate flags, high-intensity rotating, flashing, oscillating, or strobe lights.

Option:

If work vehicles are on the shoulder, a SHOULDER WORK sign may be used. For mowing operations, the sign MOWING AHEAD may be used.

Where the activity is spread out over a distance of more than 2 mi., the SHOULDER WORK sign may be repeated every 1 mi.

A supplementary plaque with the message NEXT XX MI may be used.

Guidance:

A general warning sign like ROAD MACHINERY AHEAD should be used if workers and equipment must occasionally move onto the shoulder.

Section G.07 Work on the Shoulder with No Encroachment

Support:

Chapter D and Section G.05 contain additional information regarding the steps to follow when pedestrian or bicycle facilities are affected by the worksite.

The provisions of this Section apply to short-term through long-term stationary operations.

Standard:

When paved shoulders having a width of 8 ft. or more are closed, at least one advance warning sign shall be used. In addition, channelizing devices shall be used to close the shoulder in advance to delineate the beginning of the work space and direct motor vehicle traffic to remain within the traveled way.

Guidance:

When paved shoulders having a width of 8 ft. or more are closed on freeways and expressways, road users should be warned about potential disabled vehicles that cannot get off the traveled way. An initial general warning sign (such as ROAD WORK AHEAD) should be used, followed by a RIGHT or LEFT SHOULDER CLOSED sign. Where the end of the shoulder closure extends beyond the distance which can be perceived by road users, a supplementary plaque bearing the message NEXT XX FEET or MI should be placed below the SHOULDER CLOSED sign. On multilane, divided highways, signs advising of shoulder work or the condition of the shoulder should be placed only on the side of the affected shoulder.

When an improved shoulder is closed on a high-speed roadway, it should be treated as a closure of a portion of the road system because road users expect to be able to use it in emergencies. Road users should be given ample advance warning that shoulders are closed for use as refuge areas throughout a specified length of the approaching temporary traffic control zone. The sign(s) should read SHOULDER CLOSED with distances indicated. The work space on the shoulder should be closed off by a taper or channelizing devices with a length of 0.33 L using the formulas in Table 3.

When the shoulder is not occupied but work has adversely affected its condition, the LOW SHOULDER or SOFT SHOULDER sign should be used, as appropriate.

Where the condition extends over a distance in excess of 1 mi, the sign should be repeated at 1 mi intervals.

Option:

In addition, a supplementary plaque bearing the message NEXT XX MILES may be used. Temporary traffic barriers may be needed to inhibit encroachment of errant vehicles into the work space and to protect workers.

Standard:

When used for shoulder work, arrow panels shall operate only in the caution mode.

Support:

A typical application for stationary work operations on shoulders is shown in Case A16. Short duration or mobile work on shoulders is shown in Case A7. Work on freeway shoulders is shown in Case E3.

Section G.08 Work on the Shoulder with Minor Encroachment

Support:

Chapter D and Section G.05 contain additional information regarding the steps to follow when pedestrian or bicycle facilities are affected by the worksite.

Guidance:

When work takes up part of a lane, vehicular traffic volumes, vehicle mix (buses, trucks, cars, and bicycles), speed, and capacity, should be analyzed to determine whether the affected lane should be closed. Unless the lane encroachment permits a remaining lane width of 10 ft., the lane should be closed.

Truck off-tracking should be considered when determining whether the minimum lane width of 10 ft. is adequate.

Option:

A lane width of 8 ft. may be used for short-term stationary work on low-volume, low-speed roadways when vehicular traffic does not include longer and wider heavy commercial vehicles.

Support:

Case A4 illustrates a method for handling vehicular traffic where stationary or short duration work space encroaches slightly into the traveled way.

Section G.09 Work Within the Median

Support:

Chapter D and Section G.05 contain additional information regarding the steps to follow when pedestrian or bicycle facilities are affected by the worksite.

Guidance:

If work in the median of a divided highway is within 15 ft. from the edge of the traveled way for either direction of travel, temporary traffic control should be used through the use of advance warning signs and channelizing devices.

Section G.10 Work Within the Traveled Way of Two-Lane Highways

Support:

Chapter D and Section G.05 contain additional information regarding the steps to follow when pedestrian or bicycle facilities are affected by the worksite.

Detour signs are used to direct road users onto another roadway. At diversions, road users are directed onto a temporary roadway or alignment placed within or adjacent to the right-of-way. Typical applications for detouring or diverting road users on two-lane highways are shown in Cases A12, B5, and B6. Case A12 illustrates the controls around an area where a section of roadway has been closed and a diversion has been constructed. Channelizing devices and pavement markings are used to indicate the transition to the temporary roadway.

Guidance:

When a detour is long, Detour (M4-8, M4-9) signs should be installed to remind and reassure road users periodically that they are still successfully following the detour.

When an entire roadway is closed, as illustrated in Case B5, a detour should be provided and road users should be warned in advance of the closure. If local road users are allowed to use the roadway up to the closure, the ROAD CLOSED AHEAD, LOCAL TRAFFIC ONLY sign should be used. The portion of the road open to local road users should have adequate signing, marking, and delineation.

Detours should be signed so that road users will be able to traverse the entire detour route and back to the original roadway as shown in Case B6.

Techniques for controlling vehicular traffic under one-lane, two-way conditions are described in Section C.10.

Option:

Flaggers may be used as shown in Case A6.

STOP/YIELD sign control may be used on roads with low traffic volumes as shown in Cases A10 and A11.

A temporary traffic control signal may be used as shown in Cases D5A and D5B.

Section G.11 Work Within the Traveled Way of Urban Streets

Support:

Chapter D and Section G.05 contain additional information regarding the steps to follow when pedestrian or bicycle facilities are affected by the worksite.

In urban temporary traffic control zones, decisions are needed on how to control vehicular traffic, such as how many lanes are required, whether any turns need to be prohibited at intersections, and how to maintain access to business, industrial, and residential areas.

Pedestrian traffic needs separate attention. Chapter D contains information regarding pedestrian movements near temporary traffic control zones.

Standard:

If the temporary traffic control zone affects the movement of pedestrians, adequate pedestrian access and walkways shall be provided. If the temporary traffic control zone affects an accessible and detectable pedestrian facility, the accessibility and detectability shall be maintained along the alternate pedestrian route.

If the temporary traffic control zone affects the movement of bicyclists, adequate access to the roadway, bicycle paths, or shared-use paths shall be provided (see Part 9 of the “Manual on Uniform Traffic Control Devices”).

Where transit stops are affected or relocated because of work activity, access to temporary transit stops shall be provided.

Guidance:

If a designated bicycle route is closed because of the work being done, a signed alternate route should be provided. Bicyclists should not be directed onto the path used by pedestrians.

Work sites within the intersection should be protected against inadvertent pedestrian incursion by providing detectable channelizing devices.

Support:

Utility work takes place both within and outside the roadway to construct and maintain services such as power, gas, light, water, or telecommunications. Operations often involve intersections, since that is where many of the network junctions occur. The work force is usually small, only a few vehicles are involved, and the number and types of temporary traffic control devices placed in the temporary traffic control zone is usually minimal.

Standard:

All temporary traffic control devices shall be retroreflective or illuminated if utility work is performed during nighttime hours.

Guidance:

As discussed under short-duration projects, however, the reduced number of devices in utility work zones should be offset by the use of high-visibility devices, such as high-intensity, rotating, flashing, oscillating, or strobe lights on work vehicles or high-level warning devices.

Support:

Cases A6, B4A, B4B, B4C, C1, C2, C3, C4, and E4 are examples of typical applications for utility operations. Other Cases might apply as well.

Section G.12 Work Within the Traveled Way of Multilane, Nonaccess Controlled Highways

Support:

Chapter D and Section G.05 contain additional information regarding the steps to follow when pedestrian or bicycle facilities are affected by the worksite.

Work on multilane (two or more lanes in one direction) highways is divided into right-lane closures, left-lane closures, interior-lane closures, multiple-lane closures, and closures on five lane roadways.

Standard:

When a lane is closed on a multilane road for other than a mobile operation, a transition area containing a merging taper shall be used.

Guidance:

When justified by an engineering study, temporary traffic barriers should be used to prevent incursions of errant vehicles into hazardous areas or work space.

Standard:

When temporary traffic barriers are placed immediately adjacent to the traveled way, they shall be equipped with appropriate channelizing devices, delineation, and/or other temporary traffic control devices. For lane closures, the merging taper shall use channelizing devices and the temporary traffic barrier shall be placed beyond the transition area.

Support:

It must be recognized that although temporary traffic barriers are shown in several of the Cases, they are not considered to be temporary traffic control devices in themselves.

Option:

When the right lane is closed, temporary traffic control similar to that shown in Case E4 may be used for undivided or divided four-lane roads.

Guidance:

If morning and evening peak hour vehicular traffic volumes in the two directions are uneven and the greater volume is on the side where the work is being done in the right lane, consideration should be given to closing the inside lane for opposing vehicular traffic and making the lane available to the side with heavier vehicular traffic, as shown in Figure 6H-31 of the "Manual on Uniform Traffic Control Devices."

If the larger vehicular traffic volume changes to the opposite direction at a different time of the day, the temporary traffic control should be changed to allow two lanes for opposing vehicular traffic by moving the devices from the opposing lane back to the centerline. When it is necessary to create a temporary centerline that is not consistent with the pavement markings, channelizing devices should be used and closely spaced.

Option:

When closing a left lane on a multilane undivided road, as vehicular traffic flow permits, the two interior lanes may be closed, as shown in Figure 6H-30 of the "Manual on Uniform Traffic Control Devices," to provide drivers and workers additional lateral clearance and to provide access to the work space.

Standard:

When only the left lane is closed on undivided roads, channelizing devices shall be placed along the centerline as well as along the adjacent lane.

Guidance:

When an interior lane is closed, an adjacent lane should also be considered for closure to provide additional space for vehicles and materials and to facilitate the movement of equipment within the work space.

When multiple lanes in one direction are closed, a capacity analysis should be made to determine the number of lanes needed to accommodate vehicular traffic needs. Vehicular traffic should be moved over one lane at a time. As shown in Case E5, the tapers should be separated by a distance of $2L$, with L being determined by the formulas in Table 3.

Standard:

When a directional roadway is closed, inapplicable **WRONG WAY** signs and markings, and other existing traffic control devices at intersections within the temporary two-lane, two-way operations section shall be covered, removed, or obliterated.

Option:

When half the road is closed on an undivided highway, both directions of vehicular traffic may be accommodated as shown in Case E12. When both interior lanes are closed, temporary traffic controls may be used as indicated in Figure 6H-30 of the "Manual on Uniform Traffic Control Devices." When a roadway must be closed on a divided highway, a median crossover may be used (see Section G.16).

Support:

Temporary traffic control for lane closures on five-lane roads is similar to other multilane undivided roads. Case E12 can be adapted for use on five-lane roads. Case E7 can be used on a five-lane road for short duration and mobile operations.

Section G.13 Work Within the Traveled Way at an Intersection

Support:

Chapter D and Section G.05 contain additional information regarding the steps to follow when pedestrian or bicycle facilities are affected by the worksite.

The typical cases for intersections are classified according to the location of the work space with respect to the intersection area (as defined by the extension of the curb or edge lines). The three classifications are near side, far side, and in-the-intersection. Work spaces often extend into more than one portion of the intersection. For example, work in one quadrant often creates a near-side work space on one street and a far-side work space on the cross street. In such instances, an appropriate temporary traffic control plan is obtained by combining features shown in two or more of the intersection and pedestrian typical cases.

Temporary traffic control zones in the vicinity of intersections might block movements and interfere with normal road user flows. Such conflicts frequently occur at more complex signalized intersections having such features as traffic signal heads over particular lanes, lanes allocated to specific movements, multiple signal phases, and signal detectors for actuated control, and accessible pedestrian signals and detectors.

Guidance:

The effect of the work upon signal operation should be considered, such as signal phasing for ensuring adequate capacity, maintaining or adjusting signal detectors, and ensuring the appropriate visibility of signal heads.

Standard:

When work will occur near intersections where operational, capacity, or pedestrian visibility problems are anticipated, the highway agency having jurisdiction shall be contacted.

Guidance:

For work at an intersection, advance warning signs, devices, and markings should be used on all cross streets, as appropriate. The typical applications depict urban intersections on arterial streets. Where the posted speed limit, the off-peak 85th-percentile speed prior to the work starting, or the anticipated speed exceeds 40 mph, additional warning signs should be used in the advance warning area.

Pedestrian crossings near temporary traffic control sites should be separated from the worksite by appropriate barriers that maintain the accessibility and detectability for pedestrians with disabilities.

Support:

Near-side work spaces, as depicted in Case B4C, are simply handled as a midblock lane closure. A problem that might occur with near-side lane closure is a reduction in capacity, which during certain hours of operation could result in congestion and backups.

Option:

When near-side work spaces are used, an exclusive turn lane may be used for through vehicular traffic.

Where space is restricted in advance of near-side work spaces, as with short block spacing, two warning signs may be used in the advance warning area, and a third action-type warning or a regulatory sign (such as Keep Left) may be placed within the transition area.

Support:

Far-side work spaces, as depicted in Cases B4B and B4C involve additional treatment because road users typically enter the activity area by straight-through and left- or right-turning movements.

Guidance:

When a lane through an intersection must be closed on the far side, it should also be closed on the near-side approach to preclude merging movements within the intersection.

Option:

If there are a significant number of vehicles turning from a near-side lane that is closed on the far side, the near-side lane may be converted to an exclusive turn lane.

Support:

Case B4A provides guidance on applicable procedures for work performed within the intersection.

Option:

If the work is within the intersection, any of the following strategies may be used:

- A. A small work space so that road users can move around it, as shown in Case B4A;
- B. Flaggers or uniformed law enforcement officers to direct road users, as shown in Case B4A;
- C. Work in stages so the work space is kept to a minimum; and
- D. Road closures or upstream diversions to reduce road user volumes.

Guidance:

Depending on road user conditions, a flagger(s) and/or a uniformed law enforcement officer(s) should be used to control road users.

Section G.14 Work Within the Traveled Way of Freeways and Expressways

Support:

Problems of temporary traffic control might occur under the special conditions encountered where vehicular traffic must be moved through or around temporary traffic control zones on high-speed, high-volume roadways. Although the general principles outlined in the previous Sections of this Manual are applicable to all types of highways, high-speed, access-controlled highways need special attention in order to safely and efficiently accommodate vehicular traffic while also protecting work forces. The road user volumes, road vehicle mix (buses, trucks, cars, and bicycles), and speed of vehicles on these facilities require that careful temporary traffic control procedures be implemented, for example, to induce critical merging maneuvers well in advance of work spaces and in a manner that creates minimum turbulence and delay in the vehicular traffic stream. These situations often require more conspicuous devices than specified for normal rural highway or urban street use. However, the same important basic considerations of uniformity and standardization of general principles apply for all roadways.

Work under high-speed, high-volume vehicular traffic on a controlled access highway is complicated by the roadway design and operational features. The presence of a median that establishes separate roadways for directional vehicular traffic flow might prohibit the closing of one of the roadways or the diverting of motor vehicle traffic to the other roadway. Lack of access to and from adjacent roadways prohibits rerouting of vehicular traffic away from the work space in many cases. Other conditions exist where work must be limited to night hours, thereby necessitating increased use of warning lights, illumination of work spaces, and advance warning systems.

Temporary traffic control for a typical lane closure on a divided highway is shown in Case E4. Temporary traffic controls for short duration and mobile operations on freeways are shown in Case E7. A typical application for shifting vehicular traffic lanes around a work space is shown in Case E8. Temporary traffic control for multiple and interior lane closures on a freeway is shown in Case E5 and Case E6.

Guidance:

The method for closing an interior lane when the open lanes have the capacity to carry vehicular traffic should be as shown in Case E5. When the capacity of the other lanes is needed, the method shown in Case E6 should be used.

Section G.15 Two-Lane, Two-Way Traffic on One Roadway of a Normally Divided Highway

Support:

Two-lane, two-way operation on one roadway of a normally divided highway is a typical procedure that requires special consideration in the planning, design, and work phases, because unique operational problems (for example, increasing the risk of head-on crashes) can arise with the two-lane, two-way operation.

Standard:

When two-lane, two-way traffic control must be maintained on one roadway of a normally divided highway, opposing vehicular traffic shall be separated with either temporary traffic barriers (concrete safety-shape or approved alternate) or with channelizing devices throughout the length of the two-way operation. The use of markings and complementary signing, by themselves, shall not be used.

Support:

Case E9 shows the procedure for two-lane, two-way operation. Treatments for entrance and exit ramps within the two-way roadway segment of this type of work are shown in Cases F1 thru F8.

Section G.16 Crossovers

Guidance:

The following are considered good guiding principles for the design of crossovers:

- A. Tapers for lane drops should be separated from the crossovers, as shown in Case E9.
- B. Crossovers should be designed for speeds no lower than 10 mph below the posted speed, the off-peak 85th-percentile speed prior to the work starting, or the anticipated operating speed of the roadway, unless unusual site conditions require that a lower design speed be used.

- C. A good array of channelizing devices, delineators, and full-length, properly placed pavement markings should be used to provide drivers with a clearly defined travel path.
- D. The design of the crossover should accommodate all vehicular traffic, including trucks and buses.

Support:

Temporary traffic barriers and the excessive use of temporary traffic control devices cannot compensate for poor geometric and roadway cross-section design of crossovers.

Section G.17 Interchanges

Guidance:

Access to interchange ramps on limited-access highways should be maintained even if the work space is in the lane adjacent to the ramps. Access to exit ramps should be clearly marked and delineated with channelizing devices. For long-term projects, conflicting pavement markings should be removed and new ones placed. Early coordination with officials having jurisdiction over the affected cross streets and providing emergency services should occur before ramp closings.

Option:

If access is not possible, ramps may be closed by using signs and Type III barricades. As the work space changes, the access area may be changed, as shown in Case F3. A temporary traffic control zone in the exit ramp may be handled as shown in Cases F2.

When a work space interferes with an entrance ramp, a lane may need to be closed on the freeway. A temporary traffic control zone in the entrance ramp may require shifting ramp vehicular traffic. Temporary traffic control for both operations is shown in Cases F5, F6, and F7.

Section G.18 Intentionally Left Blank

Section G.19 Work in the Vicinity of Highway-Rail Grade Crossings

Standard:

When highway-rail grade crossings exist either within or in the vicinity of a temporary traffic control zone, lane restrictions, flagging, or other operations shall not create conditions where vehicles can be queued across the railroad tracks. If the queuing of vehicles across the tracks cannot be avoided, a uniformed law enforcement officer or flagger shall be provided at the crossing to prevent vehicles from stopping on the tracks, even if automatic warning devices are in place.

Support:

Case A17 shows work in the vicinity of a highway-rail grade crossing.

Guidance:

Early coordination with the railroad company should occur before work starts.

Section G.20 Temporary Traffic Control During Nighttime Hours

Support:

Chapter D and Section G.05 contain additional information regarding the steps to follow when pedestrian or bicycle facilities are affected by the worksite.

Conducting highway construction and maintenance activities during night hours could provide an advantage when traditional daytime traffic control strategies cannot achieve an acceptable balance between worker and public safety, traffic and community impact, and constructability. The two basic advantages of working at night are reduced traffic congestion and less involvement with business activities. However, the two basic conditions that must normally be met for night work to offer any advantage are reduced traffic volumes and easy set up and removal of the traffic control patterns on a nightly basis.

Shifting work activities to night hours, when traffic volumes are lower and normal business is less active, might offer an advantage in some cases, as long as the necessary work can be completed and the work site restored to essentially normal operating conditions to carry the higher traffic volume during non-construction hours.

Although working at night might offer advantages, it also includes safety issues. Reduced visibility inherent in night work impacts the performance of both drivers and workers. Because traffic volumes are lower and congestion is minimized, speeds are often higher at night necessitating greater visibility at a time when visibility is reduced. Finally, the incidence of impaired (alcohol or drugs), fatigued, or drowsy drivers might be higher at night.

Working at night also involves other factors, including construction productivity and quality, social impacts, economics, and environmental issues. A decision to perform construction or maintenance activities at night normally involves some consideration of the advantages to be gained compared to the safety and other issues that might be impacted.

Guidance:

Considering the safety issues inherent to night work, consideration should be given to enhancing traffic controls (see Section G.04) to provide added visibility and driver guidance, and increased protection for workers.

In addition to the enhancements listed in Section G.04, consideration should be given to providing additional lights and retroreflective markings to workers, work vehicles, and equipment.

Option:

Where reduced traffic volumes at night make it feasible, the entire roadway may be closed by detouring traffic to alternate facilities, thus removing the traffic risk from the activity area.

Guidance:

Because typical street and highway lighting is rarely adequate to provide sufficient levels of illumination for work tasks, temporary lighting should be provided where workers are active to supply sufficient illumination to reasonably safely perform the work tasks.

Temporary lighting for night work should be designed such that glare does not interfere with driver visibility, or create visibility problems for truck drivers, equipment operators, flaggers, or other workers.

Consideration should also be given to stationing uniformed law enforcement officers and lighted patrol cars at night work locations where there is a concern that high speeds or impaired drivers might result in undue risks for workers or other drivers.

Standard:

Except in emergencies, temporary lighting shall be provided at all flagger stations.

Support:

Desired illumination levels vary depending upon the nature of the task involved. An average horizontal luminance of 50 lux (5 foot candles) can be adequate for general activities. An average horizontal luminance of 108 lux (10 foot candles) can be adequate for activities around equipment. Tasks requiring high levels of precision and extreme care can require an average horizontal luminance of 216 lux (20 foot candles).

CHAPTER H. INTENTIONALLY LEFT BLANK

CHAPTER I. CONTROL OF TRAFFIC THROUGH TRAFFIC INCIDENT MANAGEMENT AREAS

Section I.01 General

Standard:

The needs and control of all road users (motorists, bicyclists, and pedestrians within the highway, including persons with disabilities in accordance with the American with Disabilities Act of 1990 (ADA), Title II, Paragraph 35.130) through a temporary traffic control zone shall be an essential part of highway construction, utility work, maintenance operations, and the management of traffic incidents.

Support:

A traffic incident is an emergency road user occurrence, a natural disaster, or other unplanned event that affects or impedes the normal flow of traffic.

A traffic incident management area is an area of a highway where temporary traffic controls are imposed by authorized officials in response to a road user incident, natural disaster, hazardous material spill or other unplanned incident. It is a type of temporary traffic control zone and extends from the first warning device (such as a sign, light or cone) to the last temporary traffic control device or to a point where vehicles return to the original lane alignment and are clear of the incident.

Traffic incidents can be divided into three general classes of duration; each of which has unique traffic control characteristics and needs. These classes are:

- A. Major—expected duration of more than 2 hours;
- B. Intermediate—expected duration of 30 minutes to 2 hours; and
- C. Minor—expected duration under 30 minutes.

The primary functions of temporary traffic control at a traffic incident management area are to move road users reasonably safely and expeditiously past or around the traffic incident, and to reduce the likelihood of secondary traffic crashes, and to preclude unnecessary use of the surrounding local road system. Examples include a stalled vehicle blocking a lane, a traffic crash blocking the traveled way, a hazardous material spill along a highway, and natural disasters such as floods and severe storm damage.

Guidance:

In order to reduce response time for traffic incidents, highway agencies, appropriate public safety agencies (law enforcement, fire and rescue, emergency communications, emergency medical, and other emergency management), and private sector responders (towing and recovery and hazardous materials contractors) should mutually plan for occurrences of traffic incidents along the major and heavily traveled highway and street system.

On-scene responders should be trained in safe practices for accomplishing their tasks in and near traffic. Responders should always be aware of their visibility to oncoming traffic and take measures to move the traffic incident as far off the traveled roadway as possible or to provide for appropriate warning.

Responders arriving at a traffic incident should, within 15 minutes of arrival on-scene, estimate the magnitude on the traffic incident and an expected time duration of the traffic incident, and the expected vehicle queue length, and then should set up the appropriate temporary traffic controls for these estimates.

Support:

While some traffic incidents might be anticipated and planned for, emergencies and disasters might pose more severe and unpredictable problems. The ability to quickly install proper temporary traffic controls might greatly reduce the effects of the incident such as secondary crashes or excessive traffic delays. An essential part of fire, rescue, spill clean-up, highway agency, and enforcement activities is the proper control of road users through the traffic incident management area in order to protect responders, victims, and other personnel at the site while providing reasonably safe traffic flow. These operations might need corroborating legislative authority for the implementation and enforcement of appropriate road user regulations, parking controls, and speed zoning. It is desirable for these statutes to provide sufficient flexibility in the authority for, and implementation of, temporary traffic control to respond to the needs of changing conditions found in traffic incident management areas.

Option:

For traffic incidents, particularly those of an emergency nature, temporary traffic control devices on hand may be used for the initial response as long as they do not themselves create unnecessary additional hazards.

Section I.02 Major Traffic Incidents

Support:

Major traffic incidents are typically traffic incidents involving hazardous materials, fatal traffic crashes involving numerous vehicles, and other natural or man-made disasters. These traffic incidents typically involve closing all or part of a roadway facility for a period exceeding 2 hours.

Guidance:

If the traffic incident is anticipated to last more than 24 hours, applicable procedures and devices set forth in other parts of this manual should be used.

Support:

A road closure can be caused by a traffic incident such as a road user crash that blocks the traveled way. Road users are usually diverted through lane shifts or detoured around the traffic incident and back to the original roadway. A combination of traffic engineering and enforcement preparations is needed to determine the detour route, and to install, maintain or operate, and then to remove the necessary traffic control devices when the detour is terminated. Large trucks are a significant concern in such a detour, especially when detouring them from a controlled-access roadway onto local or arterial streets.

During traffic incidents, large trucks might need to follow a route separate from that of automobiles because of bridge, weight, clearance, or geometric restrictions. Also, vehicles carrying hazardous material might need to follow a different route from other vehicles.

Some traffic incidents such as hazardous material spills might require closure of an entire highway. Through road users must have adequate guidance around the traffic incident. Maintaining good public relations is desirable. The cooperation of the news media in publicizing the existence of, and reasons for, traffic incident management areas and their temporary traffic control can be of great assistance in keeping road users and the general public well informed.

The establishment, maintenance, and prompt removal of lane diversions can be effectively managed by inter-agency planning that includes representatives of highway and public safety agencies.

Guidance:

All traffic control devices needed to set up the temporary traffic control at the traffic incident should be available so that they can be readily deployed for all major traffic incidents. The temporary traffic control should include the proper traffic diversions, tapered lane closures, and upstream warning devices to alert traffic to the end of a queue.

Attention should be paid to the end of the traffic queue such that warning is given to road users approaching the end of the queue.

If manual traffic control is needed it should be provided by qualified flaggers or uniformed law enforcement officers.

Option:

If flaggers are used to provide traffic control or an incident management situation, the flagger may use appropriate traffic control devices that are readily available or that can be brought to the traffic incident scene on short notice.

Guidance:

When flares are used to initiate temporary traffic control at traffic incidents, more permanent traffic control devices should replace them as soon as practical. Both the flare and its supporting device should be removed from the roadway.

On-scene responders should be trained in safe practices for accomplishing their tasks in and near traffic. Responders should always be aware of their visibility to oncoming traffic and take measures to move the traffic incident as far off the traveled roadway as possible or to provide appropriate warning.

Section I.03 Intermediate Traffic Incidents

Support:

Intermediate traffic incidents typically affect travel lanes for a time period of 30 minutes to 2 hours, and usually require traffic control on the scene to divert road users past the blockage. Full roadway closures might be needed for short periods during traffic incident clearance to allow traffic incident responders to accomplish their tasks.

The establishment, maintenance, and prompt removal of lane diversions can be effectively managed by inter-agency planning that includes representatives of highway and public safety agencies.

Guidance:

All traffic control devices needed to set up the temporary traffic control at the traffic incident should be available so that they can be readily deployed for all intermediate traffic incidents. The temporary traffic control should include the proper traffic diversions, tapered lane closures, and upstream warning devices to alert approaching traffic to the end of a queue.

Attention should be paid to the end of the traffic queue such that warning is given to road users approaching the end of the queue.

If manual traffic control is needed, it should be provided by qualified flagger or uniformed law enforcement officers.

Option:

If flaggers are used to provide traffic control for an incident management situation, the flaggers may use appropriate traffic control devices that are readily available or that can be brought to the traffic incident scene on short notice.

Guidance:

When flares are used to initiate temporary traffic control at traffic incidents, more permanent traffic devices should replace them as soon as practical. Both the flare and its supporting device should be removed from the roadway.

On-scene responders should be trained in safe practices for accomplishing their tasks in and near traffic. Responders should always be aware of their visibility to oncoming traffic and take measures to move the traffic incident as far off the traveled roadway as possible or to provide for appropriate warning.

Section I.04 Minor Traffic Incidents

Support:

Minor traffic incidents are typically disabled vehicles and minor crashes that result in lane closures of less than 30 minutes. On-scene responders are typically law enforcement and towing companies, and occasionally highway agency service patrol vehicles.

Diversion of traffic into other lanes is often not needed or is needed only briefly. It is not generally possible or practical to set up a lane closure with traffic control devices for a minor traffic incident. Traffic control is the responsibility of on-scene responders.

Guidance:

When a minor traffic incident blocks a travel lane, it should be removed from that lane to the shoulder as quickly as possible.

Section I.05 Use of Emergency-Vehicle Lighting

Support:

The use of emergency-vehicle lighting (such as high-intensity rotating, flashing, oscillating, or strobe lights) is essential, especially in the initial stages of a traffic incident, for the safety of emergency responders and persons involved in the traffic incident, as well as road users approaching the traffic incident. Emergency-vehicle lighting, however, provides warning only and provides no effective traffic control. It is often confusing to road users, especially at night. Road users approaching the traffic incident from the opposite direction on a divided facility are often distracted by emergency-vehicle lighting and slow their vehicles to look at the traffic incident posing a hazard to themselves and others traveling in their direction.

The use of emergency-vehicle lighting can be reduced if good traffic control has been established at a traffic incident scene. This is especially true for major traffic incidents that might involve a number of emergency vehicles. If good traffic control is established through placement of advanced warning signs and traffic control devices to divert or detour traffic, then public safety agencies can perform their tasks on scene with minimal emergency-vehicle lighting.

Guidance:

Public safety agencies should examine their policies on the use of emergency-vehicle lighting, especially after a traffic incident scene is secured, with the aim of reducing the use of this lighting as much as possible while not endangering those at the scene. Special consideration should be given to reducing or extinguishing forward facing emergency-vehicle lighting, especially on divided roadways, to reduce distractions to on-coming road users.

Vehicle headlights not needed for illumination, or to provide notice to other road users of the incident response vehicle being in an unexpected location, should be turned off at night.

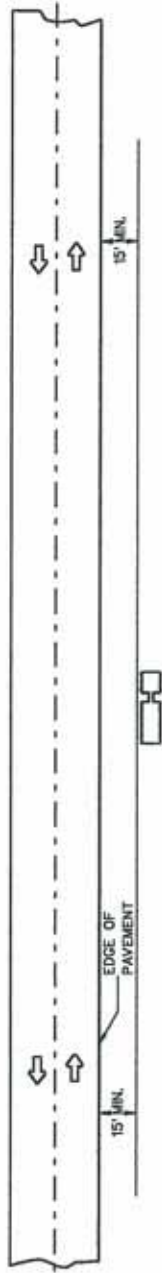

TYPICAL APPLICATIONS

LANDSCAPING WORK.
UTILITY OPERATIONS.
FENCING CONTRACTS AND MAINTENANCE.
CLEANING CULVERTS.

GENERAL NOTES

1. IF THE WORK OPERATION REQUIRES THAT TWO OR MORE WORK VEHICLES CROSS THE 15 FT. CLEAR ZONE IN ANY ONE HOUR TRAFFIC CONTROL WILL BE IN CONFORMANCE WITH CASE A3.
2. NO SPECIAL SIGNING IS REQUIRED.

CASE A1

TWO-LANE, TWO-WAY TRAFFIC.
WHERE, AT ALL TIMES, ALL VEHICLES
EQUIPMENT, WORKERS AND THEIR ACTIVITIES
ARE MORE THAN 15 FT. FROM THE EDGE
OF PAVEMENT.

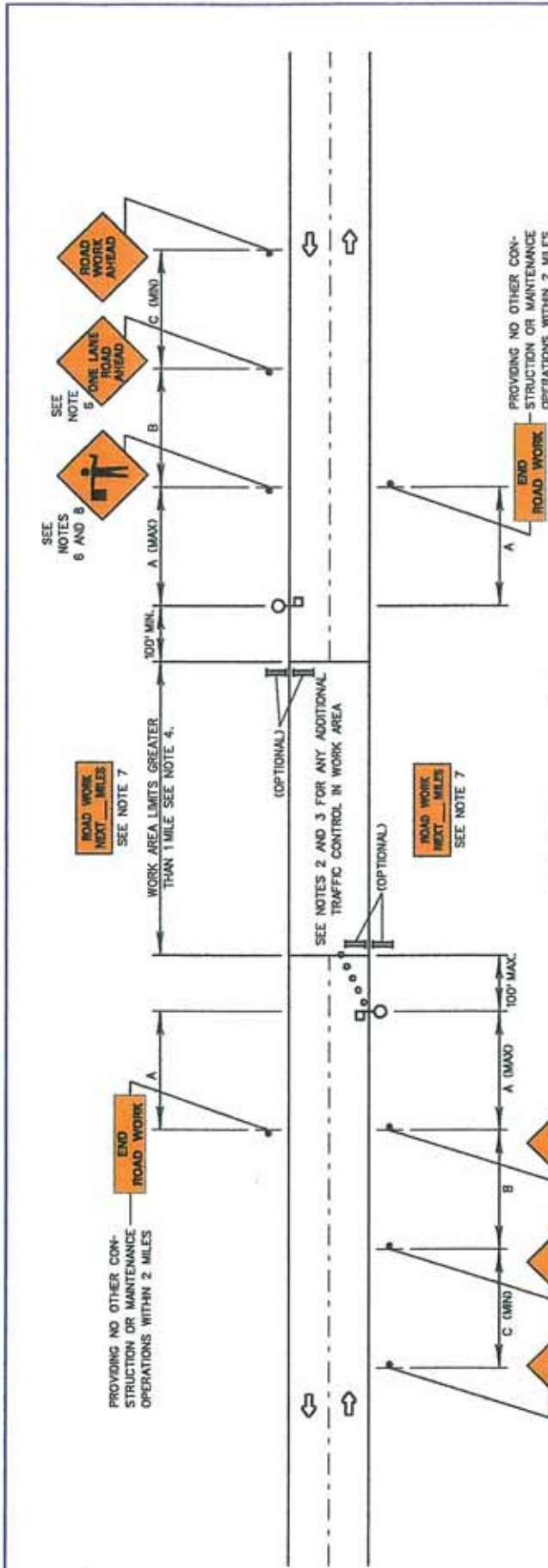

GENERAL NOTES

- FOR PROJECTS LESS THAN 1 MILE IN LENGTH THE APPROPRIATE CASE FOR THE SPECIFIC WORK AREA SHALL BE USED UNLESS DIRECTED BY THE ENGINEER.
- ADDITIONAL TRAFFIC CONTROL IN THE WORK AREA MAY BE NECESSARY. TYPE OF CONTROL WILL BE DETERMINED BY WORK BEING PERFORMED. REFER TO CASE THAT IS APPLICABLE. (EXAMPLE: CASE A1).
- WHERE THE WORK AREA EXTENDS THROUGH AN INTERSECTION, ADDITIONAL WARNING SIGNS AND TRAFFIC CONTROL (SUCH AS CASE A1) SHALL BE PROVIDED FOR THAT APPROACH.
- THE MAXIMUM CLOSURE DISTANCE SHALL BE DETERMINED BY THE ENGINEER, BUT SHALL NOT EXCEED THE LENGTH OF 1/2 DAYS OPERATION OR TWO MILES, WHICHEVER IS LESS.
- THE FLAGGERS SHALL BE IN SIGHT OF EACH OTHER OR IN DIRECT COMMUNICATIONS AT ALL TIMES.
- WHEN SUCH SIGNS ARE NO LONGER FUNCTIONAL, E.G. NIGHTTIME, SUCH SIGNS SHALL BE COVERED OR REMOVED.
- SUCH SIGNS SHALL BE ERRECTED AS DIRECTED BY THE ENGINEER BUT NORMALLY SHALL BE ERRECTED AT 1/2 MILE INCREMENTS FOR PROJECTS GREATER THAN 2 MILES IN LENGTH.
- CONTROLS THE OPERATIONS OF PILOT TRUCK IF APPLICABLE.
- FLASHING WARNING LIGHTS AND/OR FLAGS MAY BE USED TO CALL ATTENTION TO THE ABOVE WARNING SIGNS, AS NEEDED ON THE PLANS, AND/OR AS DIRECTED BY THE ENGINEER.

SYMBOLS

- WORK AREA
- ◇ SIGN
- ▬ TYPE II BARRICADE
- ↑ SIGN ON PORTABLE OR PERMANENT SUPPORT.
- FLAGGER WITH PADDLE

TYPICAL APPLICATIONS

- RESURFACING
- WIDENING
- ROADWAY STABILIZATION
- SHOULDER STABILIZATION

SUGGESTED ADVANCE WARNING SIGN SPACING

ROAD TYPE	DISTANCE BETWEEN SIGNS (IN FT)		
	A	B	C
URBAN (LOW SPEED)*	100	100	100
URBAN (HIGH SPEED)*	350	350	350
RURAL	500	500	500
EXPRESSWAY/FREEWAY	1,000	1,500	2,840

*SPEED CATEGORY TO BE DETERMINED BY WV DGH

CASE A2

TWO-LANE, TWO WAY TRAFFIC
DAY OPERATIONS NIGHTTIME
IF APPROVED BY THE ENGINEER
WHERE, AT ANY TIME, THE PROJECT LIMITS ARE GREATER THAN 1 MILE.

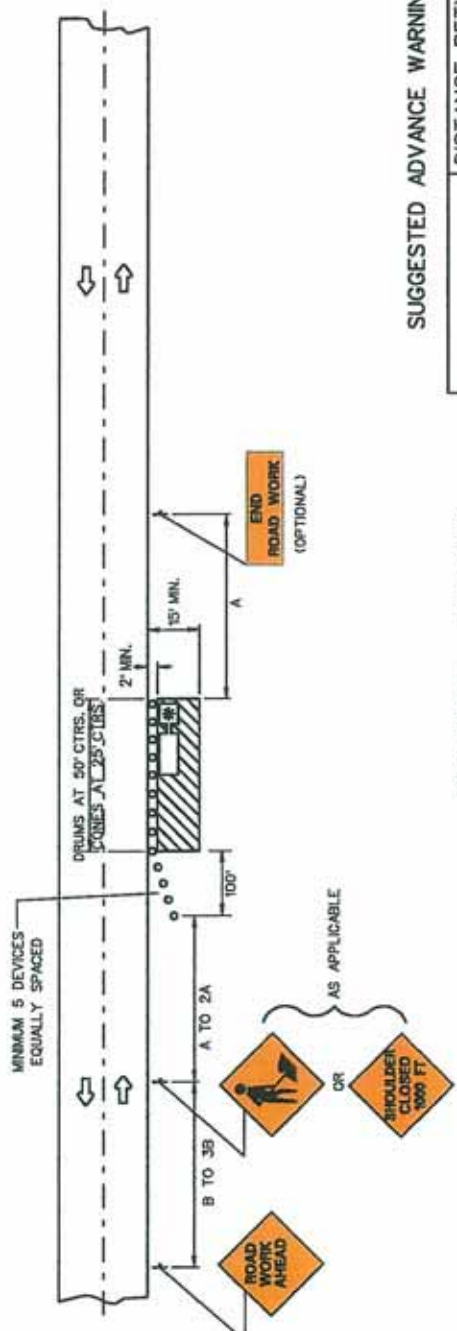

SUGGESTED ADVANCE WARNING SIGN SPACING

ROAD TYPE	DISTANCE BETWEEN SIGNS (IN FT)		
	A	B	C
URBAN (LOW SPEED)*	100	100	100
URBAN (HIGH SPEED)*	350	350	350
RURAL	500	500	500
EXPRESSWAY/FREEWAY	1,000	1,500	2,640

*SPEED CATEGORY TO BE DETERMINED BY WV DOH

GENERAL NOTES

- OVERNIGHT OPERATIONS ILLUSTRATED AND IF SUCH USE DRUMS, FOR DAYLIGHT OPERATIONS ONLY, USE CONES OR DRUMS AS DIRECTED BY THE ENGINEER.
- ANY UNATTENDED OBSTACLE OR EXCAVATION IN THE WORK AREA OVERNIGHT SHALL BE PROTECTED BY TYPE I OR TYPE II BARRICADES.
- IF THE WORK OPERATION REQUIRES THAT FOUR OR MORE WORK VEHICLES ENTER THE THROUGH TRAFFIC LANES IN A ONE HOUR PERIOD A FLAGGER SHALL BE PROVIDED AND THE FLAGGER SIGN SHALL BE USED (AT 500 FT. IN ADVANCE).
- ALL VEHICLES, EQUIPMENT, WORKERS AND THEIR ACTIVITIES ARE RESTRICTED AT ALL TIMES TO ONE SIDE OF THE PAVEMENT UNLESS OTHERWISE AUTHORIZED BY THE ENGINEER.
- FLASHING WARNING LIGHTS AND/OR FLAGS MAY BE USED TO CALL ATTENTION TO THE ABOVE WARNING SIGNS, AS NEEDED ON THE PLANS, AND/OR AS DIRECTED BY THE ENGINEER.

CASE A3

TWO-LANE, TWO-WAY TRAFFIC.
DAY OR NIGHT OPERATIONS.
(STATIONARY)
WHERE, AT ANY TIME, ANY VEHICLE, EQUIPMENT, WORKERS OR THEIR ACTIVITIES WILL ENCROACH IN THE AREA BETWEEN 2 FT. AND 15 FT. FROM THE EDGE OF PAVEMENT.

SYMBOLS

- WORK AREA
- SIGN
- SIGN ON PORTABLE OR PERMANENT SUPPORT.
- CONES OR DRUMS.

TYPICAL APPLICATIONS

- CULVERT EXTENSIONS.
- SIDE SLOPE CHANGES.
- GUARDRAIL INSTALLATION AND MAINTENANCE.
- DELINEATOR INSTALLATION AND MAINTENANCE.
- LANDSCAPING OPERATIONS.
- CLEANING DITCHES AND DRAINAGE STRUCTURES.
- SHOULDER REPAIR.
- ADJACENT WORK ON SIDE ROADS/BRIDGES
- SIGNING OPERATIONS.

A. FOR ANY OPERATION THAT ENCROACHES UPON THE ROADWAY FOR A PERIOD OF LESS THAN 30 MINUTES, WITH TWO-WAY TRAFFIC POSSIBLE.

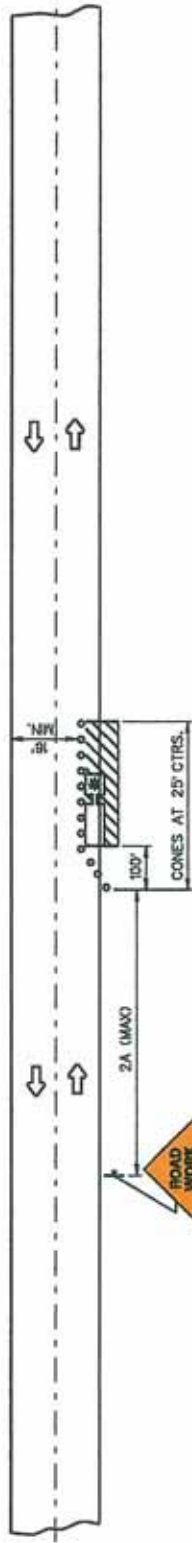

B. FOR ANY OPERATION THAT ENCROACHES UPON THE ROADWAY FOR A PERIOD OF MORE THAN 30 MINUTES, WITH TWO-WAY TRAFFIC POSSIBLE, THE OPERATION SHALL NOT EXCEED 8 HOURS UNLESS TRAFFIC VOLUME IS LESS THAN 500 ADT.

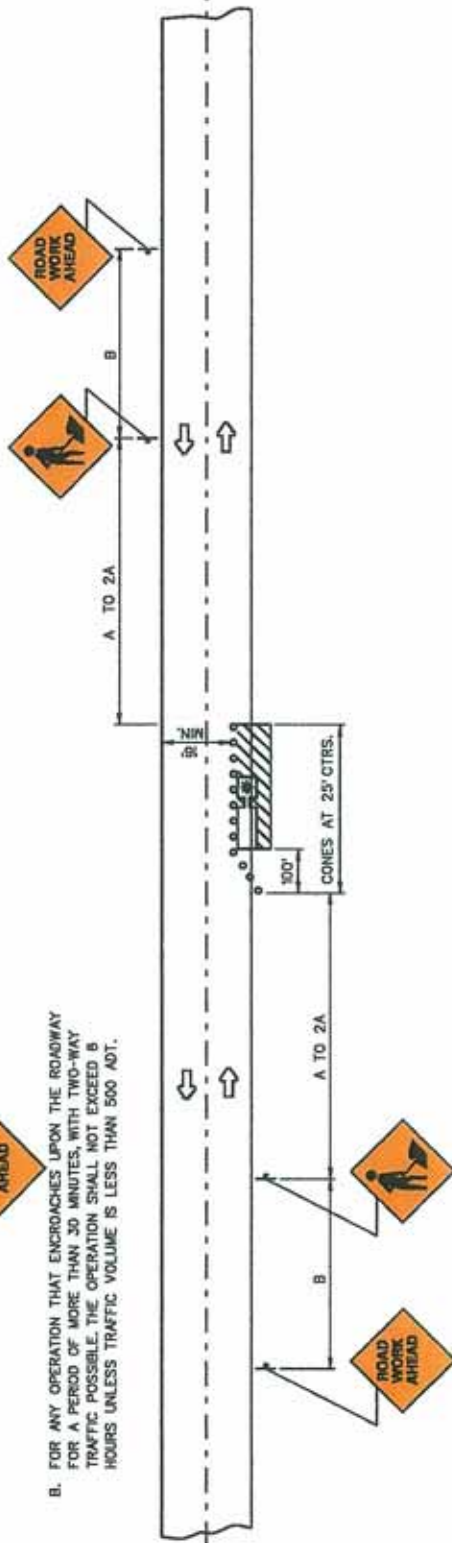

SYMBOLS

▨ WORK AREA

◇ SIGN

† SIGN ON PORTABLE OR PERMANENT SUPPORT.

○ CONES

GENERAL NOTES

1. IF THE WORK OPERATION REQUIRES THAT FOUR OR MORE WORK VEHICLES ENTER THE THROUGH TRAFFIC LANES IN A ONE HOUR PERIOD A FLAGGER SHALL BE PROVIDED AND THE FLAGGER SIGN SHALL BE USED OR SUBSTITUTED FOR THE SECOND ADVANCE SIGN.
 2. ANY UNATTENDED OBSTACLE OR EXCAVATION IN THE WORK AREA SHALL BE PROTECTED BY TYPE I OR TYPE II BARRICADES, AND IF NIGHTTIME WITH FLASHING LIGHTS (TYPE "A").
 3. ALL VEHICLES, EQUIPMENT, WORKERS AND THEIR ACTIVITIES ARE RESTRICTED AT ALL TIMES TO ONE SIDE OF THE PAVEMENT UNLESS OTHERWISE AUTHORIZED BY THE ENGINEER.
 4. IF IT BECOMES NECESSARY TO OPERATE ONE LANE TRAFFIC, CASE A6 OR CASE A11 SHALL APPLY AS APPROPRIATE.
- * WORK VEHICLE SHALL HAVE DUAL FLASHERS AND FLASHING AMBER DOME LIGHT OPERATING.

TYPICAL APPLICATIONS

SIGNING OPERATIONS.
 MAINTENANCE OPERATIONS.
 GUARDRAIL MAINTENANCE.
 SIGNAL AND LIGHTING MAINTENANCE.
 UTILITY OPERATIONS.

SUGGESTED ADVANCE WARNING SIGN SPACING

ROAD TYPE	DISTANCE BETWEEN SIGNS (IN FT.)		
	A	B	C
URBAN (LOW SPEED)*	100	100	100
URBAN (HIGH SPEED)*	350	350	350
RURAL	500	500	500
EXPRESSWAY/FREEWAY	1,000	1,500	2,840

*SPEED CATEGORY TO BE DETERMINED BY WV DOH

CASE A4

TWO-LANE, TWO-WAY TRAFFIC,
 DAY OR NIGHT OPERATIONS,
 FOR LESS THAN 8 HOURS
 OR FOR LESS THAN 500 ADT

WHERE, AT ANY TIME, ANY VEHICLE,
 EQUIPMENT, WORKERS OR THEIR AC-
 TIVITIES WILL ENCROACH UPON THE
 ROADWAY, MAINTAINING TWO-WAY
 TRAFFIC

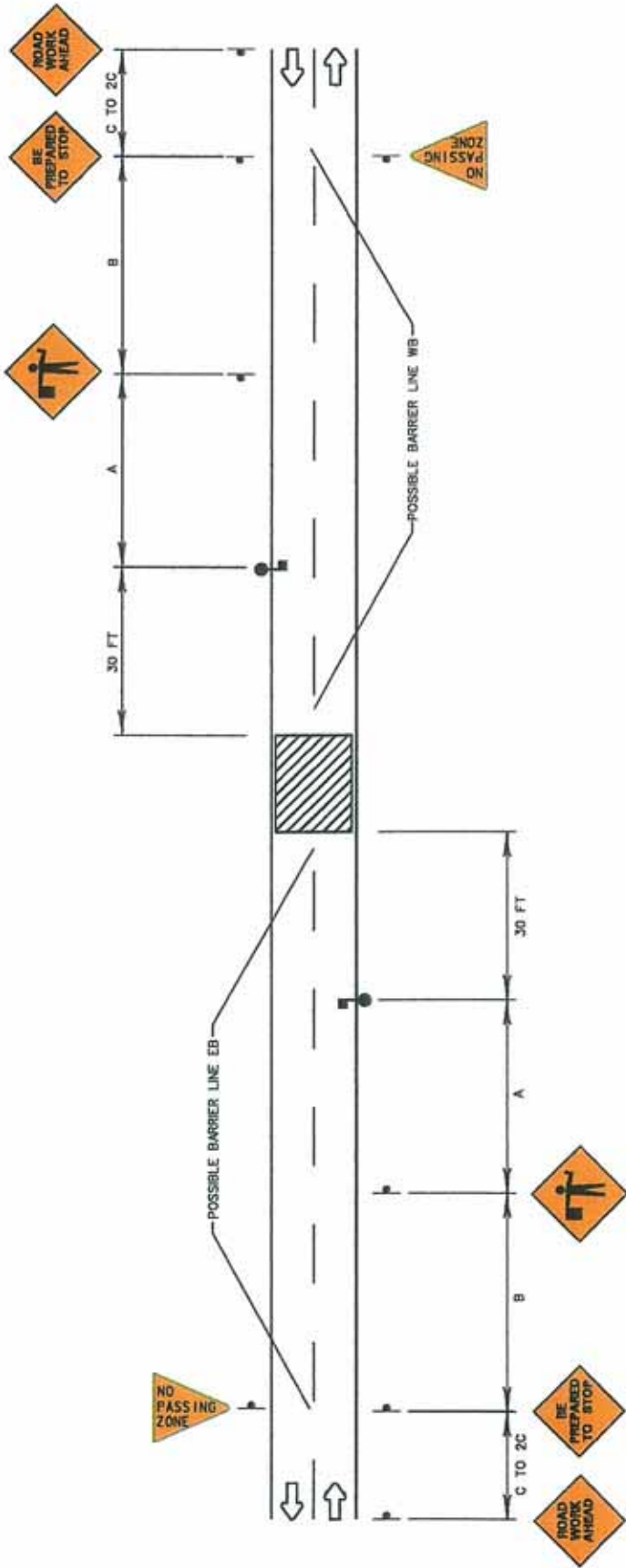

GENERAL NOTES

1. CONDITIONS REPRESENTED ARE FOR A PLANNED CLOSURE NOT EXCEEDING 30 MINUTES DURING THE DAYTIME.
2. THE FLAGGERS SHALL BE IN SIGHT OF EACH OTHER OR IN DIRECT COMMUNICATION AT ALL TIMES.
3. FLASHING WARNING LIGHTS AND/OR FLAGS MAY BE USED TO CALL ATTENTION TO THE ABOVE WARNING SIGNS, AS NEEDED ON THE PLANS, AND/OR AS DIRECTED BY THE ENGINEER.

SYMBOLS

- WORK AREA.
- SIGN ON PORTABLE OR PERMANENT SUPPORT.
- FLAGGER WITH PADDLE.

SUGGESTED ADVANCE WARNING SIGN SPACING

ROAD TYPE	DISTANCE BETWEEN SIGNS (IN FT)		
	A	B	C
URBAN (LOW SPEED)*	100	100	100
URBAN (HIGH SPEED)*	350	350	350
RURAL	800	800	500
EXPRESSWAY/FREEWAY	1000	1500	2,640

*SPEED CATEGORY TO BE DETERMINED BY WV DOH

TYPICAL APPLICATIONS

- SHORT TERM CLOSING
- SHORT TERM UTILITY CROSSING FOR TWO OR THREE LANE ROADWAYS
- HAUL ROADS

CASE A5

TWO-LANE, TWO-WAY TRAFFIC.
SHORT TERM OPERATIONS.
DAYTIME ONLY.

A. FOR ANY OPERATION THAT ENCROACHES IN THE AREA BETWEEN THE CENTER LINE AND A LINE 2 FT. OUTSIDE THE EDGE OF THE PAVEMENT FOR A PERIOD OF LESS THAN 15 MINUTES.

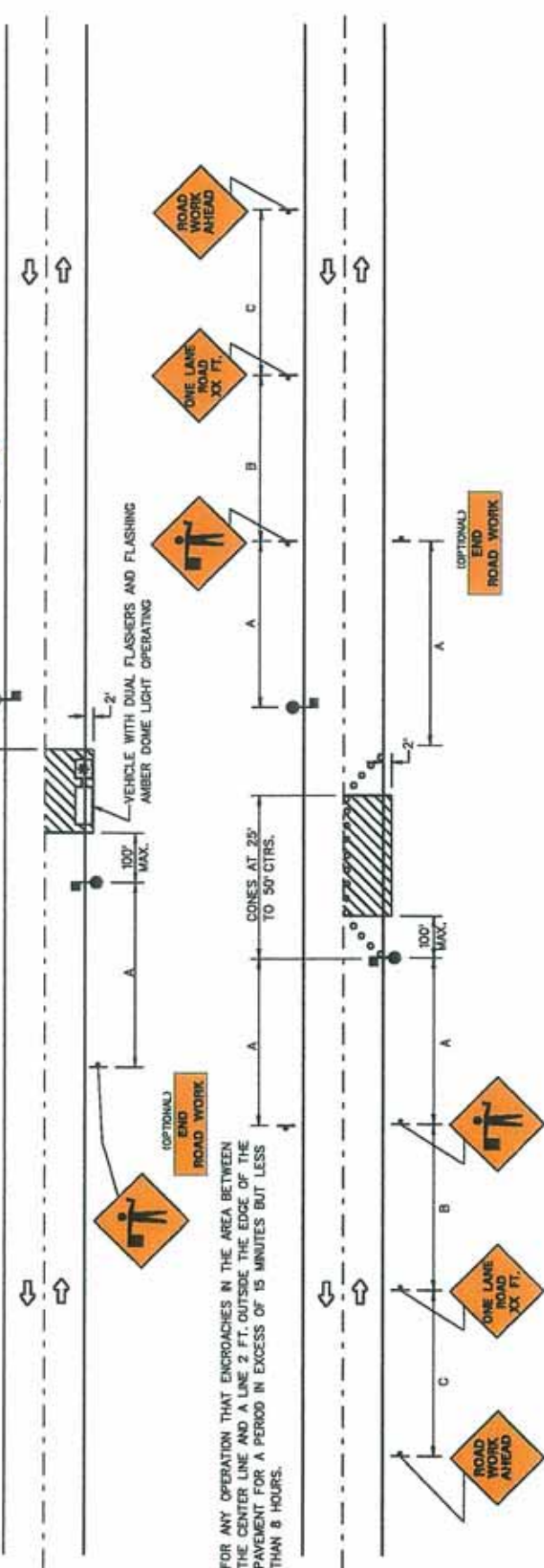

B. FOR ANY OPERATION THAT ENCROACHES IN THE AREA BETWEEN THE CENTER LINE AND A LINE 2 FT. OUTSIDE THE EDGE OF THE PAVEMENT FOR A PERIOD IN EXCESS OF 15 MINUTES BUT LESS THAN 8 HOURS.

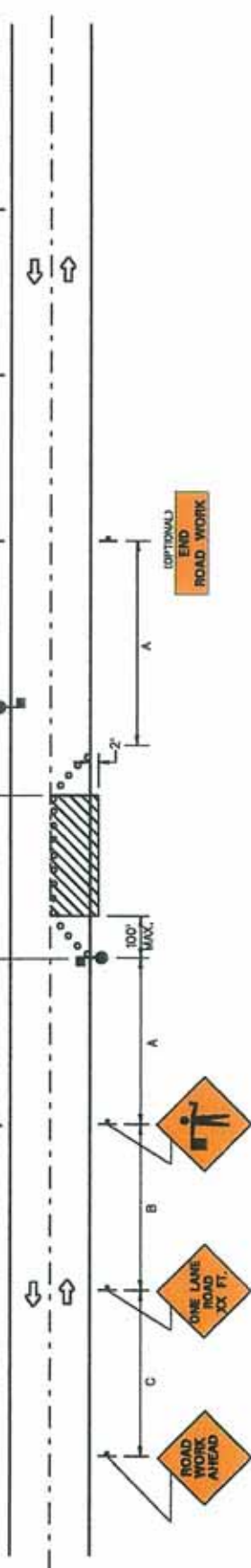

C. FOR ANY OPERATION THAT IS MORE THAN 2 FT. OUTSIDE THE EDGE OF THE PAVEMENT FOR A PERIOD OF LESS THAN 80 MINUTES.

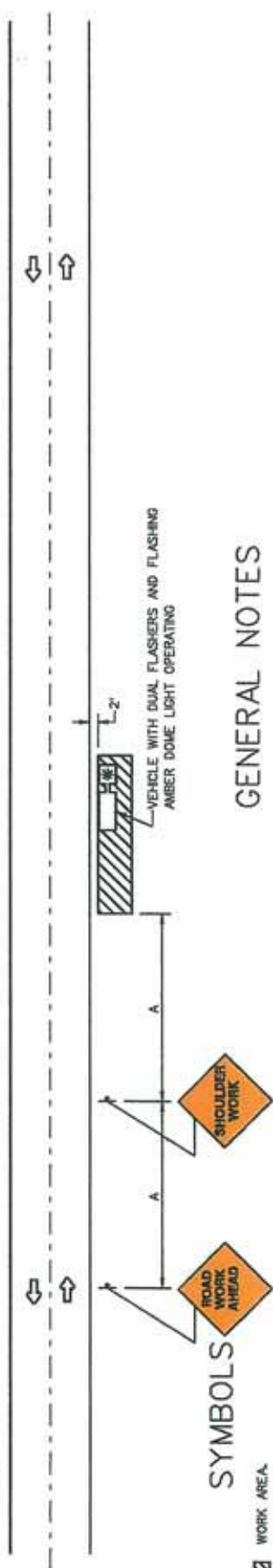

SYMBOLS

▨ WORK AREA

◇ SIGN

↑ SIGN ON PORTABLE OR PERMANENT SUPPORT.

⊙ FLAGGER WITH PADDLE.

○ CONES

GENERAL NOTES

- CONSTRUCTION OPERATIONS SHALL BE CONFINED TO ONE TRAFFIC LANE, LEAVING THE OPPOSITE LANE OPEN TO TRAFFIC. AT LEAST 500 FT. OF BOTH TRAFFIC LANES SHALL BE AVAILABLE FOR TRAFFIC MOVEMENT AT INTERVALS NOT GREATER THAN 1,000 FT. A COMPLETE TRAFFIC CONTROL PLAN MUST BE APPROVED FOR ANY PROJECT EXPECTING TO EXCEED 1,000 FT. IN LENGTH INCLUDING BOTH TAPER AND WORK AREAS.
- FOR LOW-VOLUME SITUATIONS WITH SHORT WORK ZONES ON STRAIGHT ROADWAYS WHERE THE FLAGGER IS VISIBLE TO ROAD USERS APPROACHING FROM BOTH DIRECTIONS, A SINGLE FLAGGER, POSITIONED TO BE VISIBLE TO ROAD USERS APPROACHING FROM BOTH DIRECTIONS, MAY BE USED.
- FLASHING WARNING LIGHTS AND/OR FLAGS MAY BE USED TO CALL ATTENTION TO THE ADVANCE WARNING SIGNS.
- THE FLAGGERS SHALL BE IN SIGHT OF EACH OTHER OR IN DIRECT COMMUNICATION AT ALL TIMES.
- ALL SIGNS ARE TO BE REMOVED AT COMPLETION OF THE DAY'S OPERATIONS.
- FOR MULTILANE DIVIDED ROADWAYS THE ADVANCE WARNING SIGNS FOR TRAFFIC APPROACHING FROM THE OPPOSITE DIRECTION MAY BE OMITTED IF APPROVED BY THE ENGINEER.

SUGGESTED ADVANCE WARNING SIGN SPACING

ROAD TYPE	DISTANCE BETWEEN SIGNS (IN FT)		
	A	B	C
URBAN GLOW SPEED*	100	100	100
URBAN HIGH SPEED*	350	350	350
RURAL	500	500	500
EXPRESSWAY/FREEWAY	1,000	1,500	2,540

TYPICAL APPLICATIONS

PATCHING PAVEMENT.
FIELD SURVEY.
CLEANING UP DEBRIS ON PAVEMENT.
CROSSWALK PAINTING.

CASE A6

TWO-LANE, TWO-WAY TRAFFIC
SHORT-TERM OPERATIONS
DAYTIME ONLY

*SPEED CATEGORY TO BE DETERMINED BY WY DCH

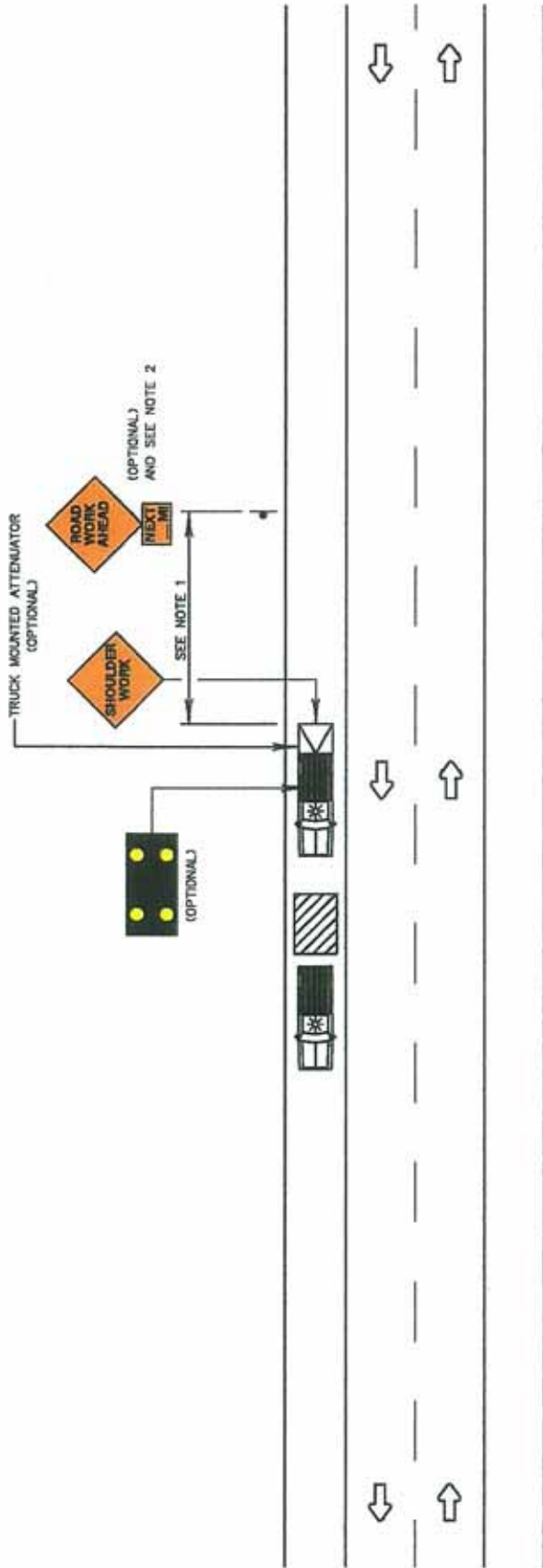

GENERAL NOTES

1. IN THOSE SITUATIONS WHERE MULTIPLE WORK LOCATIONS WITHIN A LIMITED DISTANCE MAKE IT PRACTICAL TO PLACE STATIONARY SIGNS, THE DISTANCE BETWEEN THE ADVANCE WARNING SIGN AND THE WORK SHALL NOT EXCEED 5 MILES.
2. IN THOSE SITUATIONS WHERE THE DISTANCE BETWEEN THE ADVANCE SIGNS AND THE WORK IS 2 MILES TO 5 MILES, A SUPPLEMENTAL DISTANCE PLAQUE SHALL BE USED WITH THE ROAD WORK AHEAD SIGN.
3. WARNING SIGNS MAY BE OMITTED WHEN THE WORK VEHICLE DISPLAYS HIGH-INTENSITY ROTATING, FLASHING, OSCILLATING, OR STROBE LIGHTS. IF THE DISTANCE BETWEEN WORK LOCATIONS IS 1 MILE OR MORE, AND IF THE WORK VEHICLE TRAVELS AT VEHICULAR TRAFFIC SPEEDS BETWEEN LOCATIONS.
4. ALTHOUGH VEHICLE HAZARD WARNING SIGNALS CAN BE USED TO SUPPLEMENT THE ROTATING LIGHTS OR STROBE LIGHTS, THEY SHALL NOT BE USED INSTEAD OF VEHICLES HIGH-INTENSITY ROTATING, FLASHING, OSCILLATING, OR STROBE LIGHTS.
5. IF AN ARROW PANEL IS USED FOR AN OPERATION ON THE SHOULDER, THE CAUTION MODEL SHALL BE USED.

SYMBOLS

- † SIGN ON PORTABLE OR PERMANENT SUPPORT.
- * FLASHING VEHICLE LIGHT

TYPICAL APPLICATIONS

SHOULDER REPAIR

CASE A7
TWO LANE, TWO WAY TRAFFIC
MOBILE OPERATION ON SHOULDER

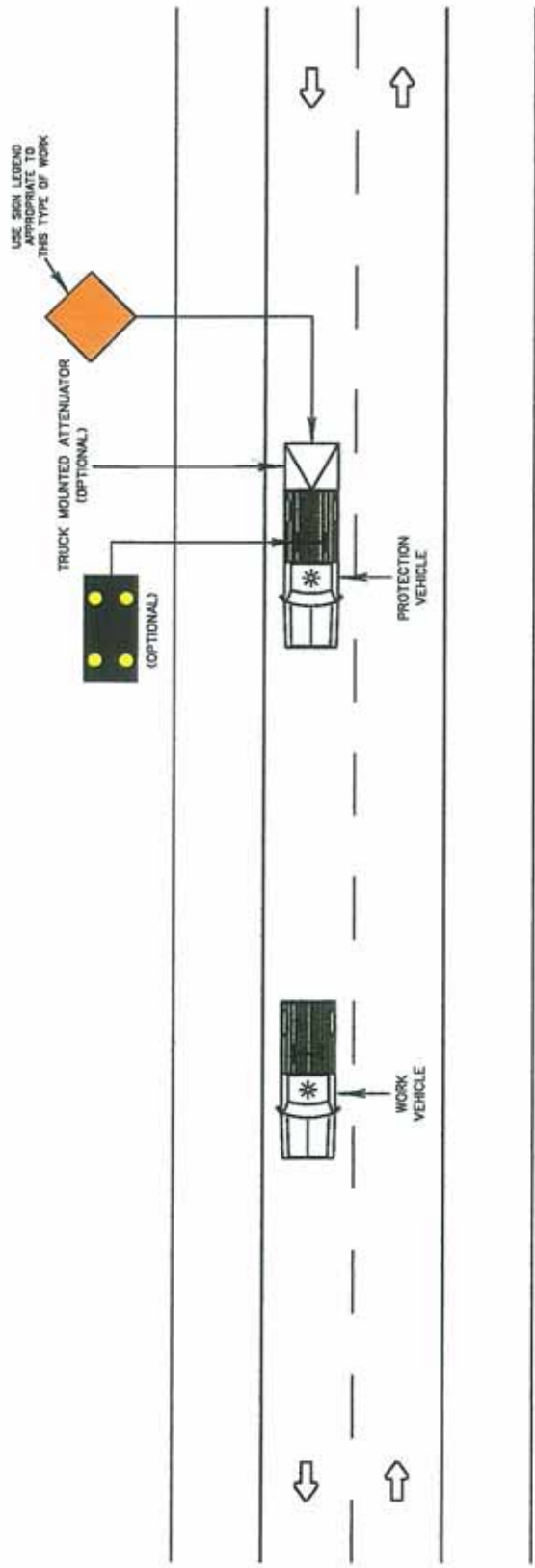

SYMBOLS

- † SIGN ON PORTABLE OR PERMANENT SUPPORT.
- * FLASHING VEHICLE LIGHT

TYPICAL APPLICATIONS

DEBRIS REMOVAL

GENERAL NOTES

1. VEHICLE-MOUNTED SIGNS SHALL BE MOUNTED IN A MANNER SUCH THAT THEY ARE NOT OBSTRUCTED BY EQUIPMENT OR SUPPLIES. SIGN LEGENDS SHALL BE COVERED OR TURNED FROM VIEW WHEN WORK IS NOT IN PROGRESS.
2. PROTECTION AND WORK VEHICLES SHALL DISPLAY HIGH-INTENSITY ROTATING, FLASHING, OSCILLATING, OR STROBE LIGHTS.
3. WHERE PRACTICAL AND WHEN NEEDED, THE WORK AND PROTECTION VEHICLES SHOULD PULL OVER PERIODICALLY TO ALLOW TRAFFIC TO PASS. IF THIS CANNOT BE DONE FREQUENTLY, AS AN ALTERNATIVE, A DO NOT PASS SIGN MAY BE PLACED ON THE REAR OF THE VEHICLE BLOCKING THE LANE.
4. WHENEVER ADEQUATE STOPPING SIGHT DISTANCE EXISTS TO THE REAR, THE PROTECTION VEHICLE SHOULD MANTAIN THE MINIMUM DISTANCE PROTECT THE WORK VEHICLE AND PROCEED AT THE SAME SPEED. THE PROTECTION VEHICLE SHOULD SLOW DOWN IN ADVANCE OF VERTICAL OR HORIZONTAL CURVES WHICH RESTRICT SIGHT DISTANCE.
5. THE USE OF TRUCK MOUNTED ATTENUATORS MOUNTED ON THE REAR OF PROTECTION VEHICLES SHOULD BE CONSIDERED.
6. THE DISTANCE BETWEEN THE WORK AND PROTECTION VEHICLES MAY VARY ACCORDING TO TERRAIN AND OTHER FACTORS.
7. ADDITIONAL PROTECTION VEHICLES TO WARN AND REDUCE THE SPEED OF ONCOMING OR OPPOSING TRAFFIC MAY BE USED. LAW ENFORCEMENT VEHICLES MAY BE USED FOR THIS PURPOSE.
8. IF AN ARROW PANEL IS USED, IT SHALL BE USED IN THE CAUTION MODE.

CASE A8

TWO-WAY, TWO-LANE TRAFFIC
MOBILE OPERATION ON
ROADWAY

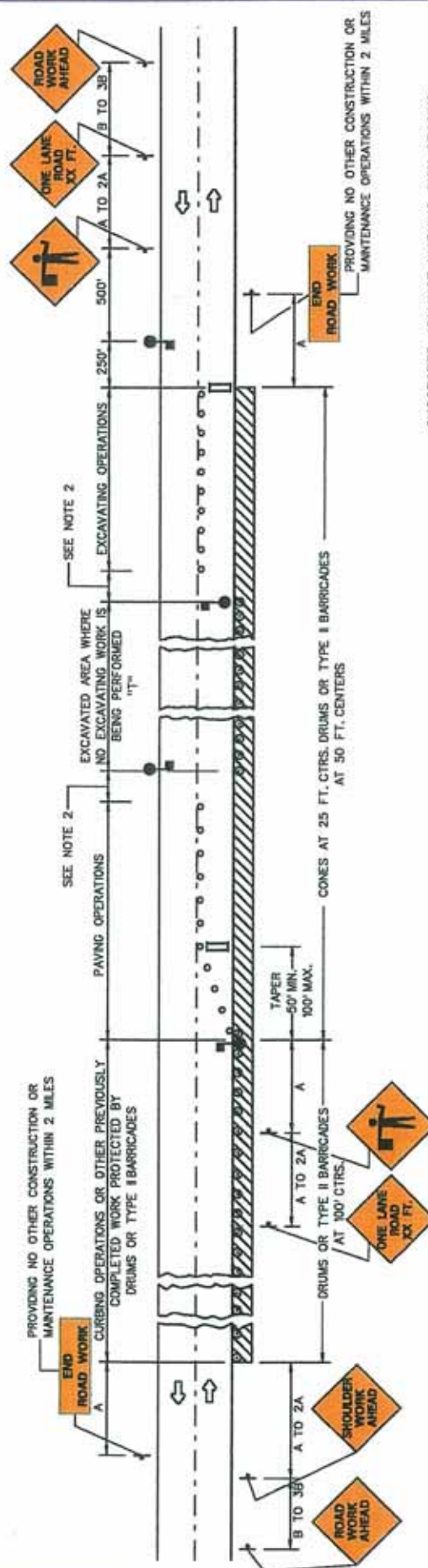

SUGGESTED ADVANCE WARNING SIGN SPACING

ROAD TYPE	DISTANCE BETWEEN SIGNS (IN FT)		
	A	B	C
URBAN (LOW SPEED)*	100	100	100
URBAN (HIGH SPEED)*	350	350	350
RURAL	500	500	500
EXPRESSWAY/FREWAY	1,000	1,500	2,640

*SPEED CATEGORY TO BE DETERMINED BY WY DOH

SYMBOLS

- WORK AREA
- SIGN
- CONES OR DRUMS (TYPE II BARRICADES OPTIONAL) AS APPLICABLE
- SIGN ON PORTABLE OR PERMANENT SUPPORT.
- FLAGGER WITH PADOLE.
- TYPE II BARRICADE.
- CHANNELIZATION DEVICES (DRUMS OR CONES).

GENERAL NOTES

1. WHERE DISTANCE "T" EXCEEDS 1,500 FT. ADDITIONAL ONE LANE ROAD 1,000 FT., AND FLAGGER SIGNS (AS NECESSARY) SHALL BE INSTALLED. THE CONES, DRUMS, OR BARRICADES MAY BE REMOVED THROUGH THE "T" AREA, AN ADDITIONAL TAPER SHALL BE FORMED BY CONES OR DRUMS IN ADVANCE OF THE EXCAVATING OPERATIONS. ADDITIONAL FLAGGER WILL BE REQUIRED AND THE EXCAVATED AREA SHALL BE PROTECTED BY DRUMS OR TYPE II BARRICADES AT 50 FT. CENTERS. MINIMUM DISTANCE IS 100 FT. WHEN "T" EXCEEDS 1,500 FT., DISTANCE SHALL BE 250 FT.
2. NO PAVING OR EXCAVATING OPERATIONS SHALL BE PERFORMED AT NIGHT UNLESS AUTHORIZED BY THE ENGINEER. WHEN THESE OPERATIONS ARE SUSPENDED ALL VEHICLES AND EQUIPMENT INCLUDING APPROPRIATE TRAFFIC CONTROL DEVICES SHALL BE REMOVED FROM THE PAVEMENT AND THE EXCAVATED AREA SHALL BE PROTECTED BY DRUMS OR TYPE II BARRICADES AT 50-FOOT CENTERS. ROAD WORK AHEAD AND SHOULDER WORK AHEAD SIGNS SHALL BE INSTALLED AS SHOWN TO PROTECT THE CURING OPERATIONS. ROAD WORK AHEAD AND ROAD WORK 1000 FT. SIGNS SHALL BE INSTALLED FOR TRAFFIC IN THE OPPOSITE DIRECTION.
3. CONSTRUCTION OPERATIONS SHALL BE CONFINED TO ONE TRAFFIC LANE AT A TIME LEAVING THE OPPOSITE LANE OPEN TO TRAFFIC. AT LEAST 500 FT. OF BOTH TRAFFIC LANES SHALL BE AVAILABLE FOR TRAFFIC MOVEMENT AT INTERVALS NOT GREATER THAN 2,500 FT. A COMPLETE TRAFFIC CONTROL PLAN MUST BE APPROVED FOR ANY PROJECT EXPECTED TO EXCEED 5,000 FT. IN LENGTH INCLUDING BOTH TAPER AND WORK AREA.
4. THE FLAGGERS SHALL BE IN SIGHT OF EACH OTHER OR IN DIRECT COMMUNICATION AT ALL TIMES.
5. ALL SIGNS SHALL BE POST MOUNTED IF THE CLOSURE TIME EXCEEDS THREE DAYS.
6. WHEN A SIDE ROAD INTERSECTS THE HIGHWAY ON WHICH WORK IS BEING PERFORMED ADDITIONAL TRAFFIC CONTROL DEVICES SHALL BE ERRECTED AS DIRECTED BY THE ENGINEER.
7. FLASHING WARNING LIGHTS AND/OR FLAGS MAY BE USED TO CALL ATTENTION TO THE ABOVE WARNING SIGNS, AS NEEDED ON THE PLANS, AND/OR AS DIRECTED BY THE ENGINEER.

TYPICAL APPLICATIONS

- PAVEMENT WIDENING.
- SHOULDER WORK.

CASE A9

TWO-LANE, TWO-WAY TRAFFIC WIDENING OF PAVEMENT DAY OR NIGHT OPERATIONS

WHERE, AT ANY TIME, ANY VEHICLE, EQUIPMENT, WORKERS OR THEIR ACTIVITIES WILL ENCRACH ON THE PAVEMENT DURING PAVEMENT WIDENING OPERATIONS.

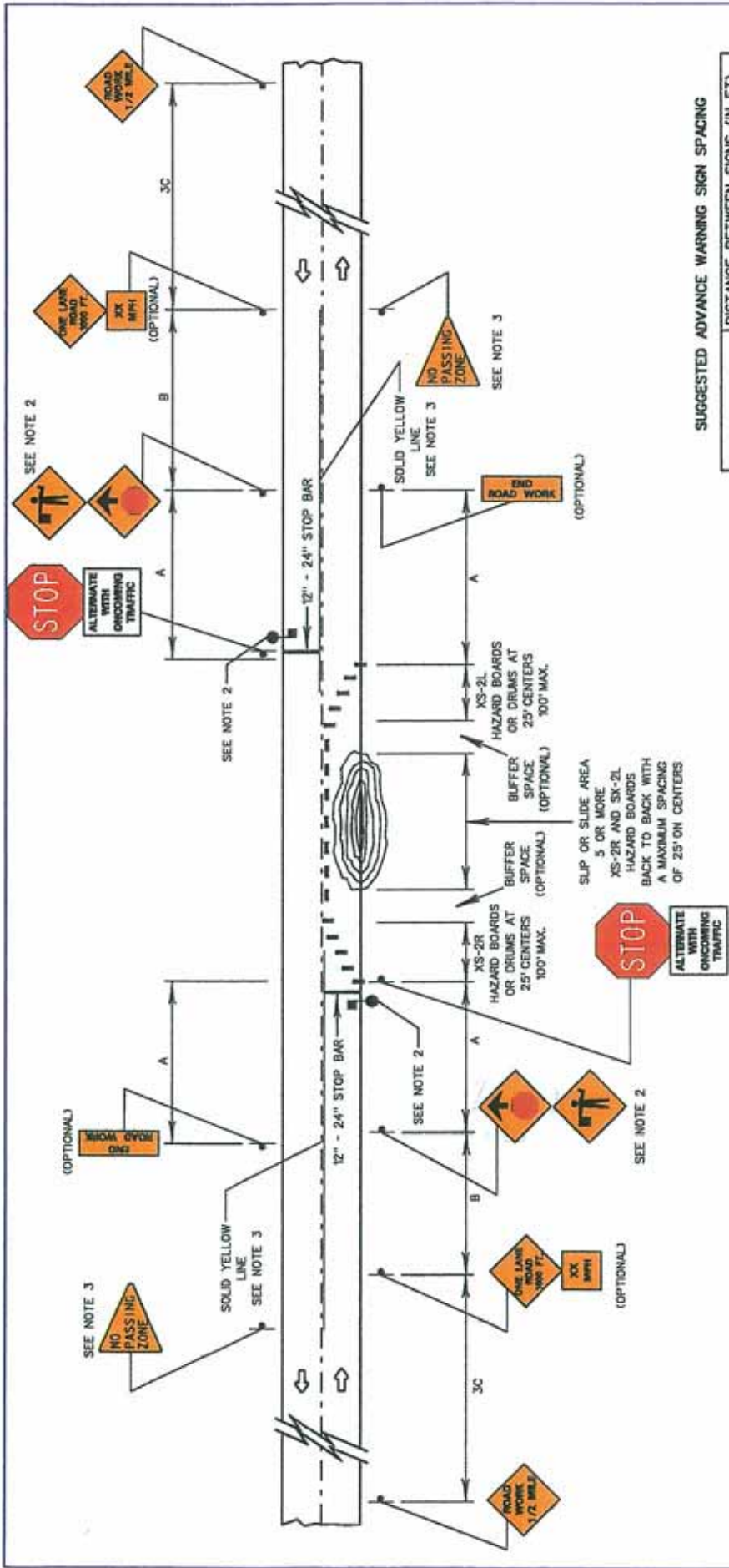

SUGGESTED ADVANCE WARNING SIGN SPACING

ROAD TYPE	DISTANCE BETWEEN SIGNS (IN FT)		
	A	B	C
URBAN (LOW SPEED)**	100	100	100
URBAN (HIGH SPEED)**	350	350	500
RURAL	500	500	500
EXPRESSWAY/FREEWAY	1,000	1,500	2,640

**SPEED CATEGORY TO BE DETERMINED BY WV DOH

GENERAL NOTES

- TO BE USED WHEN:
 - VEHICULAR TRAFFIC VOLUME IS SUCH THAT SUFFICIENT GAPS EXIST FOR VEHICULAR TRAFFIC THAT MUST YIELD.
 - ROAD USERS FROM BOTH DIRECTIONS ARE ABLE TO SEE APPROACHING VEHICULAR TRAFFIC THROUGH AND BEYOND THE WORK SITE AND HAVE SUFFICIENT VISIBILITY OF APPROACHING VEHICLES.
- FLAGGERS MAY BE USED DURING DAYLIGHT WORKING HOURS BUT IF SO THEN:
 - COVER BOTH STOP SIGNS
 - SUBSTITUTE FLAGGER SIGNS FOR BOTH STOP AHEAD SIGNS.
- THE INSTALLATION OF THE YELLOW LINES AND NO PASSING ZONE SIGNS SHALL BE MADE IF THE ONE WAY CONDITION WILL EXIST FOR LONGER THAN 30 DAYS, OR IF DIRECTED BY THE ENGINEER.

TYPICAL APPLICATIONS

SLIP AREA
SLIDE AREA

CASE A10A

LOW VOLUME
TWO-LANE, TWO WAY TRAFFIC
DAY OR NIGHT OPERATION
WHERE A SLIP OR SLIDE RESULTS
IN CLOSURE OF A LANE, RESULTING
IN ONE-LANE TWO WAY TRAFFIC.

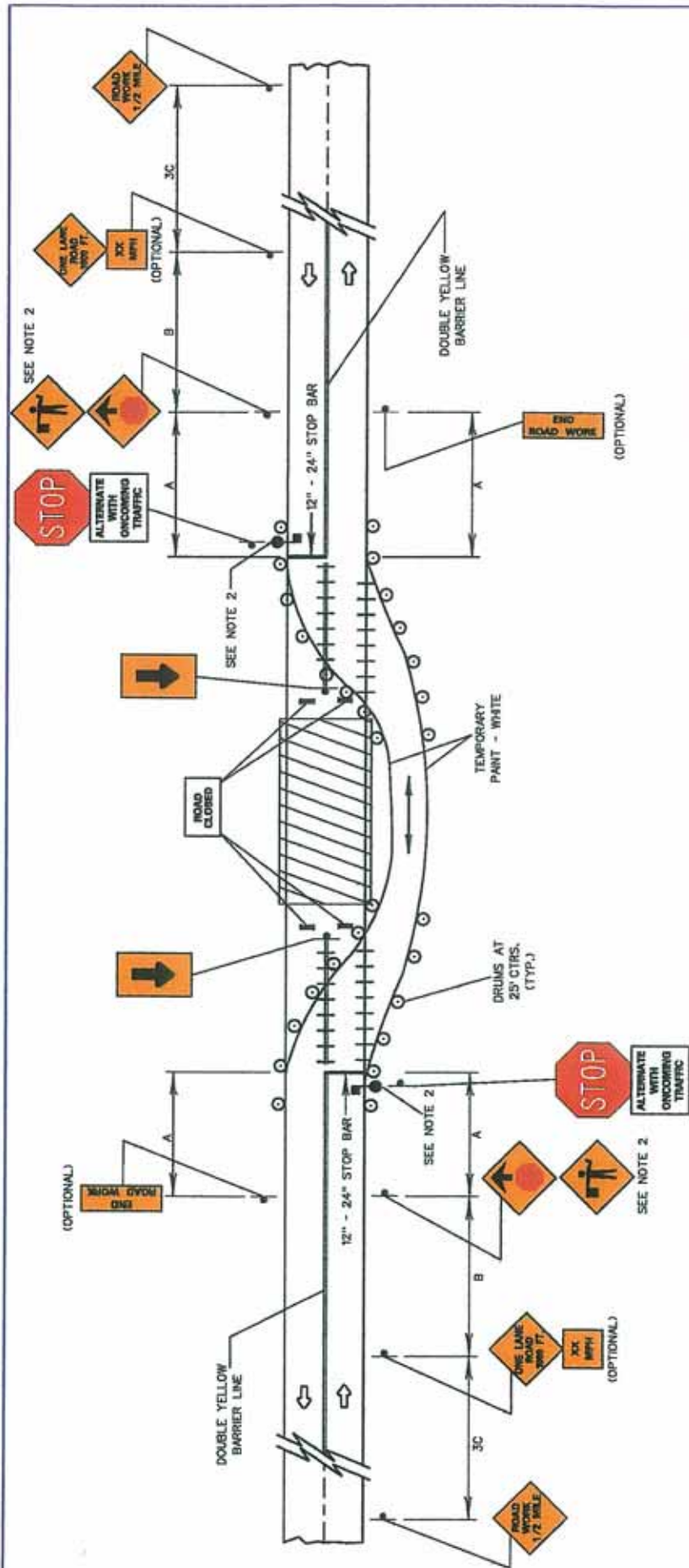

SUGGESTED ADVANCE WARNING SIGN SPACING

ROAD TYPE	A	B	C
URBAN (LOW SPEED)*	100	100	100
URBAN (HIGH SPEED)*	350	350	350
RURAL	500	500	500
EXPRESSWAY/FREEWAY	1,000	1,500	2,640

*SPEED CATEGORY TO BE DETERMINED BY WV DMV

SYMBOLS

- WORK AREA
- FLAGGER WITH PADDLE
- TYPE III BARRICADE
- ERADICATION

TYPICAL APPLICATIONS

BRIDGE REPLACEMENT

GENERAL NOTES

1. TO BE USED WHEN:
 - A. VEHICULAR TRAFFIC VOLUME IS SUCH THAT SUFFICIENT GAPS EXIST FOR VEHICULAR TRAFFIC THAT MUST YIELD.
 - B. ROAD USERS FROM BOTH DIRECTIONS ARE ABLE TO SEE APPROACHING VEHICULAR TRAFFIC THROUGH AND BEYOND THE WORK SITE AND HAVE SUFFICIENT VISIBILITY OF APPROACHING VEHICLES.
2. FLAGGERS MAY BE USED DURING DAYLIGHT WORKING HOURS BUT IF SO THEN:
 - A. COVER BOTH STOP SIGNS
 - B. SUBSTITUTE FLAGGER SIGNS FOR BOTH STOP AHEAD SIGNS.
3. FLASHING WARNING LIGHTS AND/OR FLAGS MAY BE USED TO CALL ATTENTION TO THE ABOVE WARNING SIGNS, AS NEEDED ON THE PLANS, AND/OR AS DIRECTED BY THE ENGINEER.

CASE A10B

LOW VOLUME
ONE-LANE, TWO WAY TRAFFIC
DAY OR NIGHT OPERATION

WHERE A BRIDGE REPLACEMENT RESULTS
IN CLOSURE OF A LAKE, RESULTING
IN ONE-LANE TWO WAY TRAFFIC.

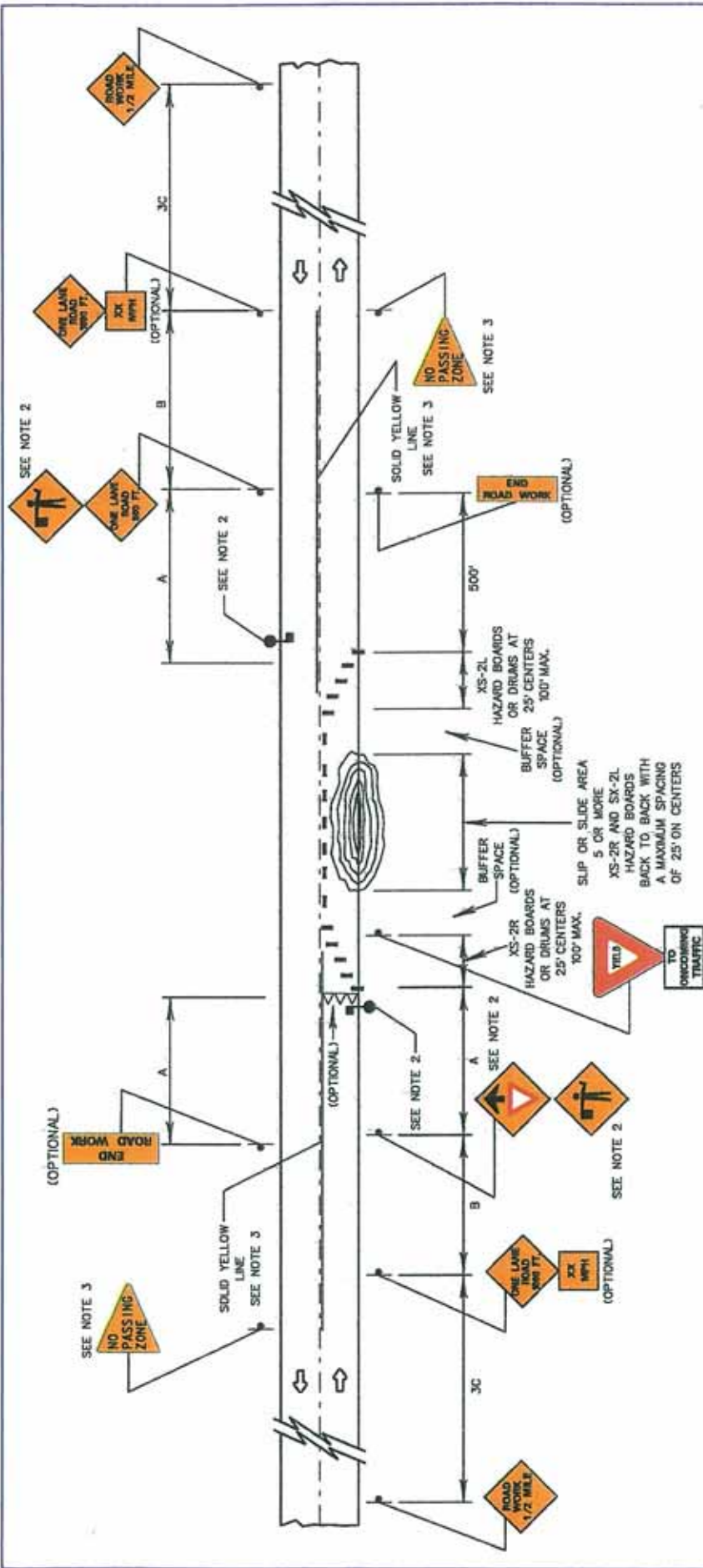

SUGGESTED ADVANCE WARNING SIGN SPACING

ROAD TYPE	DISTANCE BETWEEN SIGNS (IN FT)		
	A	B	C
URBAN (LOW SPEED)*	100	100	100
URBAN (HIGH SPEED)*	350	350	350
RURAL	500	500	500
EXPRESSWAY/FREEWAY	1,000	1,500	2,840

*SPEED CATEGORY TO BE DETERMINED BY WY DSH

GENERAL NOTES

- TO BE USED WHEN:
 - VEHICULAR TRAFFIC VOLUME IS SUCH THAT SUFFICIENT GAPS EXIST FOR VEHICULAR TRAFFIC THAT MUST YIELD. ROAD USERS FROM BOTH DIRECTIONS ARE ABLE TO SEE APPROACHING VEHICULAR TRAFFIC THROUGH AND BEYOND THE WORK SITE AND HAVE SUFFICIENT VISIBILITY OF APPROACHING VEHICLES.
- FLAGGERS MAY BE USED DURING DAYLIGHT WORKING HOURS BUT IF SO THEN
 - COVER YIELD SIGN
 - SUBSTITUTE FLAGGER SIGN FOR YIELD AHEAD SIGN.
 - SUBSTITUTE FLAGGER FOR ONE LANE ROAD 500 FT. SIGN.
- THE INSTALLATION OF THE YELLOW LINES AND NO PASSING ZONE SIGNS SHALL BE MADE IF THE ONE WAY CONDITION WILL EXIST FOR LONGER THAN 30 DAYS, OR IF DIRECTED BY THE ENGINEER.

TYPICAL APPLICATIONS

SLIP AREA
SLIDE AREA

CASE A11

LOW VOLUME
TWO-LANE, TWO WAY TRAFFIC
DAY OR NIGHT OPERATION
WHERE A SLIP OR SLIDE RESULTS
IN CLOSURE OF A LANE, RESULTING
IN ONE-LANE TWO WAY TRAFFIC.

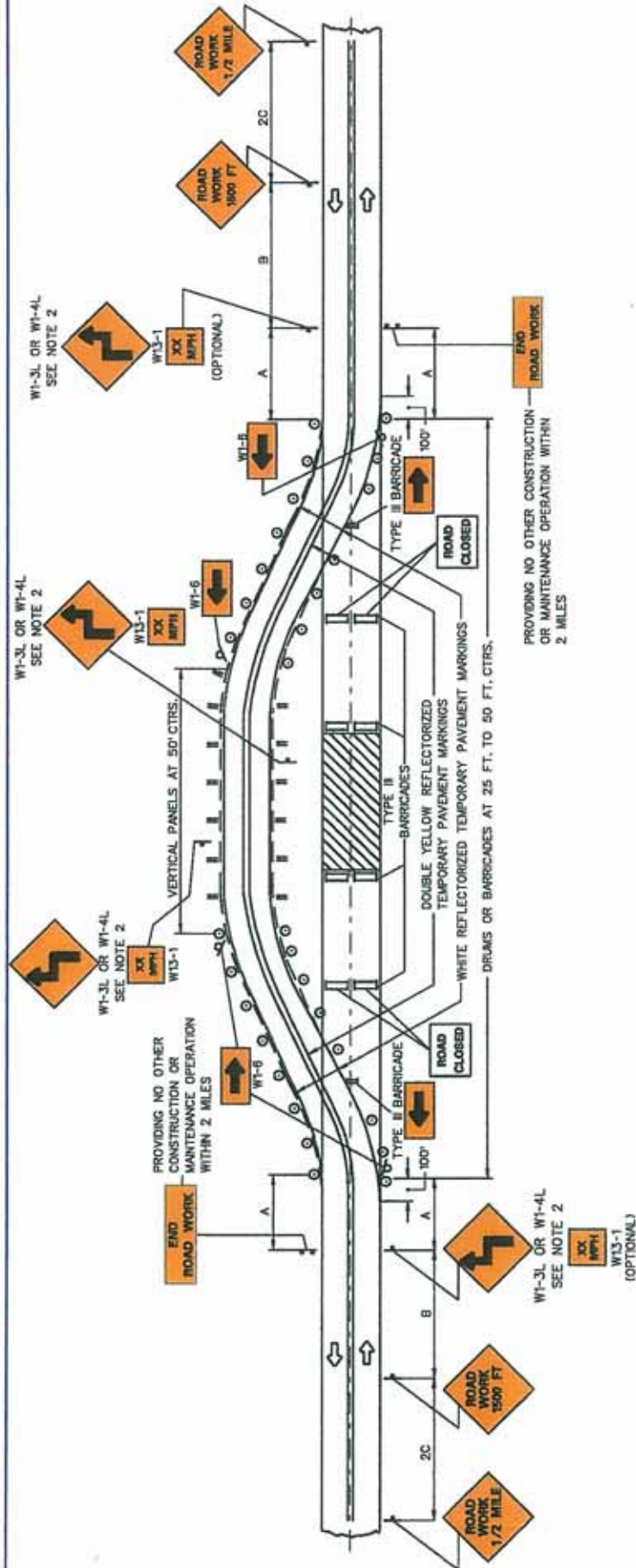

GENERAL NOTES

- ON PAVED RUNAROUNDS, PAVEMENT MARKINGS SHALL BE USED WHEN THE CLOSURE TIME EXCEEDS SEVEN DAYS OR WHEN THE NORMAL POSTED SPEED OUTSIDE THE AREA OF OPERATIONS EXCEEDS 50 M.P.H. TEMPORARY PAVEMENT MARKINGS (TAPE OR PAINT) SHALL BE USED FOR MARKING TEMPORARY CENTER LINES AND EDGE LINES ON PAVED RUNAROUNDS. ALL EXISTING MARKINGS WHICH CONFLICT WITH THE REVISED TRAFFIC PATTERN WILL BE ERADICATED ON THE PAVED RUNAROUNDS.
- WHERE CROSSOVER SPEEDS ARE GREATER THAN 30 MPH, THE REVERSE CURVE (W1-4) SHALL BE USED, WHERE CROSSOVER SPEEDS ARE 30 MPH OR LESS, THE REVERSE TURN (W1-3) SHALL BE USED.
- THE ADVISORY SAFE SPEED TO BE SHOWN BELOW THE REVERSE CURVE (TURN) SIGNS SHALL BE DETERMINED AT THE SITE AND APPROVED BY DISTRICT ENGINEER OR TRAFFIC ENGINEERING DIVISION.
- ALL SIGNS SHALL BE POST MOUNTED IF THE CLOSURE TIME EXCEEDS THREE DAYS.
- WHEN A SIDE ROAD INTERSECTS THE HIGHWAY ON WHICH WORK IS BEING PERFORMED, ADDITIONAL TRAFFIC CONTROL DEVICES SHALL BE ERECTED AS NOTED IN THE PLANS OR AS DIRECTED BY THE ENGINEER.
- TEMPORARY BASED PAVEMENT MARKERS MAY BE USED TO SUPPLEMENT PAVEMENT MARKINGS ON THE DETOUR AND APPROACHES.
- FLASHING WARNING LIGHTS AND/OR FLAGS MAY BE USED TO CALL ATTENTION TO THE ABOVE WARNING SIGNS, AS NEEDED ON THE PLANS, AND/OR AS DIRECTED BY THE ENGINEER.

SYMBOLS

- WORK AREA.
- SIGN
- TYPE II BARRICADES
- SIGN ON PORTABLE OR PERMANENT SUPPORT
- DRUM
- VERTICAL PANELS

TYPICAL APPLICATIONS

BRIDGE CONSTRUCTION.
CULVERT CONSTRUCTION.

SUGGESTED ADVANCE WARNING SIGN SPACING

ROAD TYPE	DISTANCE BETWEEN SIGNS (IN FT)		
	A	B	C
URBAN (LOW SPEED)*	100	100	100
URBAN (HIGH SPEED)*	350	350	350
RURAL	500	500	500
EXPRESSWAY/FREEWAY	1,000	1,500	2,640

*SPEED CATEGORY TO BE DETERMINED BY WV DOH

CASE A12

TWO-LANE, TWO-WAY TRAFFIC,
DAY OR NIGHT OPERATIONS.
TEMPORARY RUNAROUND

WHERE, AT ANY TIME, ANY VEHICLE,
EQUIPMENT, WORKERS OR THEIR ACTIVITIES
REQUIRE THE CLOSURE OF BOTH LANES AND
A TEMPORARY RUNAROUND IS CONSTRUCTED.

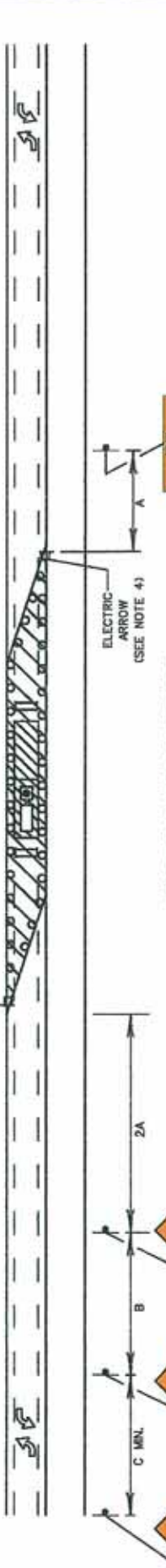

MIDDLE LANE CLOSURE

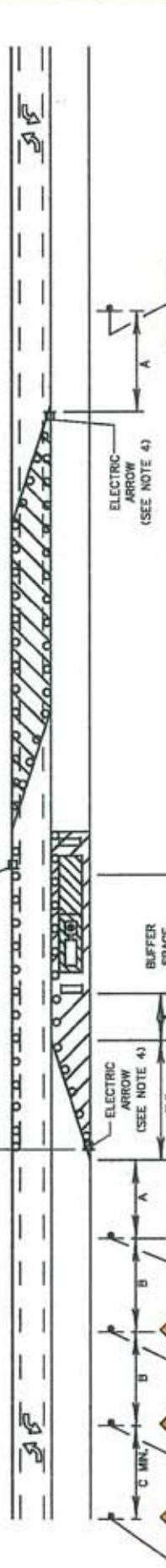

RIGHT LANE CLOSURE

GENERAL NOTES

1. OVERNIGHT OPERATIONS ILLUSTRATED AND IF SUCH, USE DRUMS. FOR DAYLIGHT OPERATIONS ONLY MAY SUBSTITUTE CONES FOR DRUMS.
2. ANY UNATTENDED OBSTACLE OR EXCAVATION IN THE WORK AREA OVERNIGHT SHALL BE PROTECTED BY TYPE I OR TYPE II BARRICADES WITH FLASHING LIGHTS (TYPE 'A').
3. WHERE THE WORK ZONE EXTENDS THROUGH AN INTERSECTION, ADDITIONAL WARNING SIGNS AND TRAFFIC CONTROL (SUCH AS CASE A8) SHALL BE PROVIDED FOR THAT APPROACH.
4. FOR LOW SPEED ENVIRONMENTS AND/OR FOR SHORT DURATION OPERATIONS, A FLAGGER - ADVANCE FLAGGER SIGN, AND R4-7A (KEEP RIGHT) OR R4-8A (KEEP LEFT) SIGN MAY BE SUBSTITUTED FOR THE ELECTRIC ARROW.
5. FLASHING WARNING LIGHTS AND/OR FLAGS MAY BE USED TO CALL ATTENTION TO THE ABOVE WARNING SIGNS, AS NEEDED ON THE PLANS, AND/OR AS DIRECTED BY THE ENGINEER.

SYMBOLS

- ▨ WORK AREA
- ◇ SIGN
- ▮ TYPE II BARRICADE
- † SIGN ON PORTABLE OR PERMANENT SUPPORT.
- DRUMS

TYPICAL APPLICATIONS

- RESURFACING
- PATCHING LEVELING
- PAVEMENT MARKINGS

SUGGESTED ADVANCE WARNING SIGN SPACING

ROAD TYPE	A	B	C
URBAN (LOW SPEED)*	100	100	100
URBAN (HIGH SPEED)*	300	350	350
RURAL	500	500	500
EXPRESSWAY/FREEWAY	1000	1000	2,640

*SPEED CATEGORY TO BE DETERMINED BY WV DOH

L-TAPER (IN FEET)

SPEED	L-TAPER (IN FEET)
25	125
30	180
35	250
40	320
45	540
50	600
55	660

CASE A13

THREE LANE, DOUBLE LEFT TURN LANE, TWO-WAY TRAFFIC

* WORK VEHICLE (IF USED) SHALL HAVE DUAL FLASHERS AND FLASHING AMBER DOME LIGHT OPERATING.

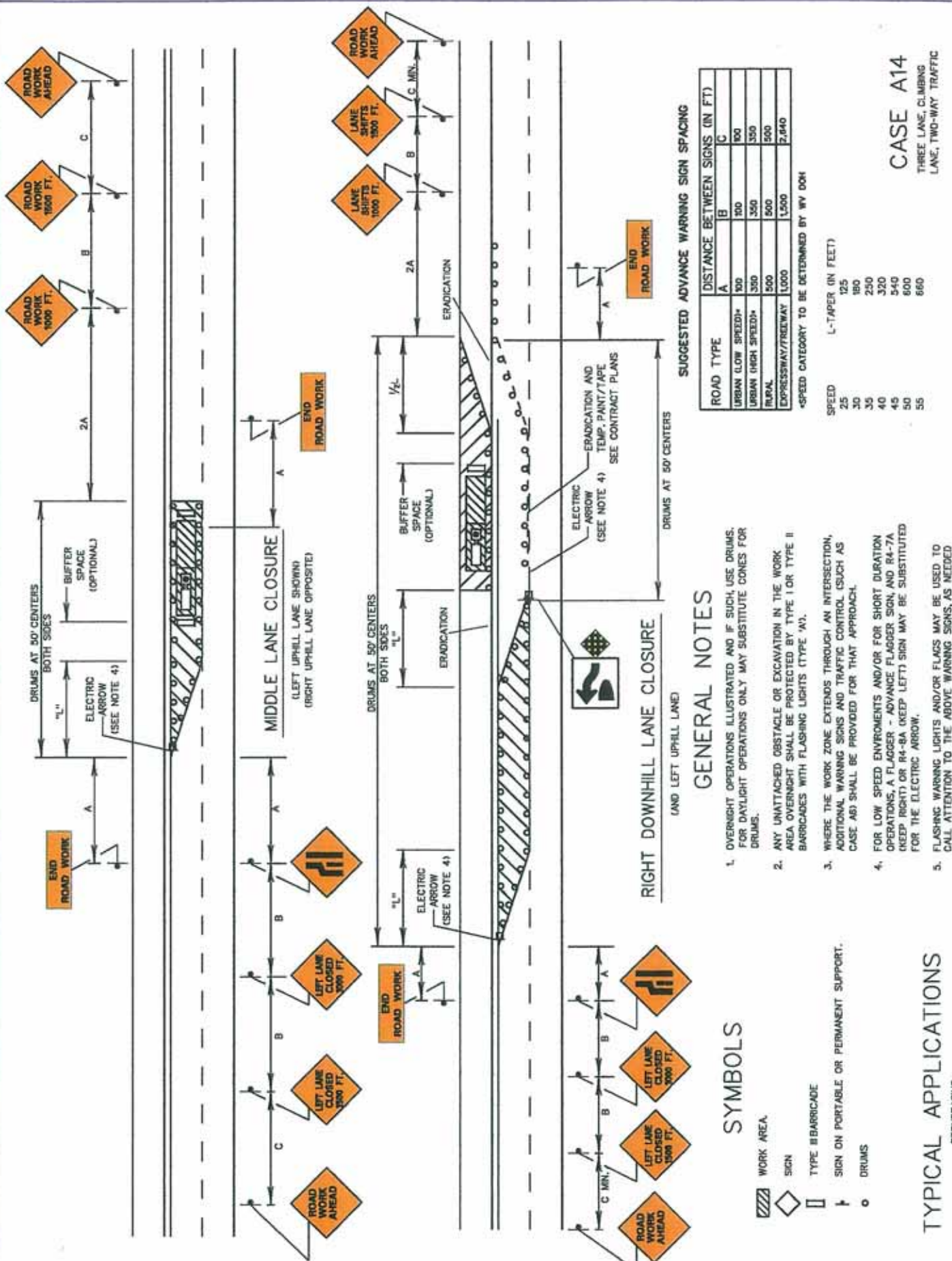

SUGGESTED ADVANCE WARNING SIGN SPACING

ROAD TYPE	A	B	C
URBAN (LOW SPEED)*	100	100	100
URBAN (HIGH SPEED)*	300	350	350
RURAL	500	500	500
EXPRESSWAY/FREEWAY	1000	1500	2,040

*SPEED CATEGORY TO BE DETERMINED BY WY DOH

L-TAPER (IN FEET)

SPEED	L-TAPER (IN FEET)
25	125
30	150
35	200
40	250
45	320
50	400
55	500
60	600
65	750

CASE A14
THREE LANE, CLIMBING
LANE, TWO-WAY TRAFFIC

GENERAL NOTES

- OVERNIGHT OPERATIONS ILLUSTRATED AND IF SUCH, USE DRUMS. FOR DAYLIGHT OPERATIONS ONLY MAY SUBSTITUTE CONES FOR DRUMS.
- ANY UNATTACHED OBSTACLE OR EXCAVATION IN THE WORK AREA OVERNIGHT SHALL BE PROTECTED BY TYPE I OR TYPE II BARRICADES WITH FLASHING LIGHTS (TYPE 'A').
- WHERE THE WORK ZONE EXTENDS THROUGH AN INTERSECTION, ADDITIONAL WARNING SIGNS AND TRAFFIC CONTROL (SUCH AS CASE A8) SHALL BE PROVIDED FOR THAT APPROACH.
- FOR LOW SPEED ENVIRONMENTS AND/OR FOR SHORT DURATION OPERATIONS, A FLAGGER - ADVANCE FLAGGER SIGN, AND R4-7A (KEEP RIGHT) OR R4-8A (KEEP LEFT) SIGN MAY BE SUBSTITUTED FOR THE ELECTRIC ARROW.
- FLASHING WARNING LIGHTS AND/OR FLAGS MAY BE USED TO CALL ATTENTION TO THE ABOVE WARNING SIGNS, AS NEEDED ON THE PLANS, AND/OR AS DIRECTED BY THE ENGINEER.

SYMBOLS

- WORK AREA
- SIGN
- TYPE II BARRICADE
- SIGN ON PORTABLE OR PERMANENT SUPPORT.
- DRUMS

TYPICAL APPLICATIONS

- RESURFACING
- PATCHING LEVELING
- SLIDES

X WORK VEHICLE (IF USED) SHALL HAVE DUAL FLASHERS AND FLASHING AMBER DOME LIGHT OPERATING.

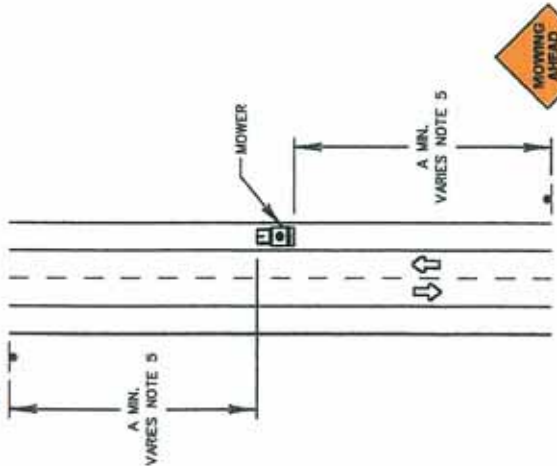

A. MOWING - NO ENCROACHMENT ON TRAVEL LANES: TWO LANE TWO WAY OPERATION

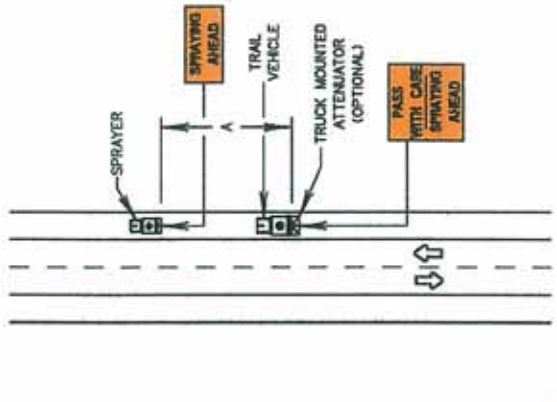

B. SPRAYING - NO ENCROACHMENT ON TRAVEL LANES: TWO LANE TWO WAY OPERATION

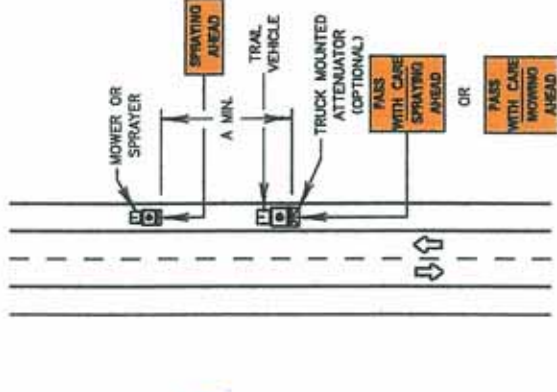

C. MOWING OR SPRAYING - ENCROACHMENT ON TRAVEL LANES: TWO LANE TWO WAY OPERATION

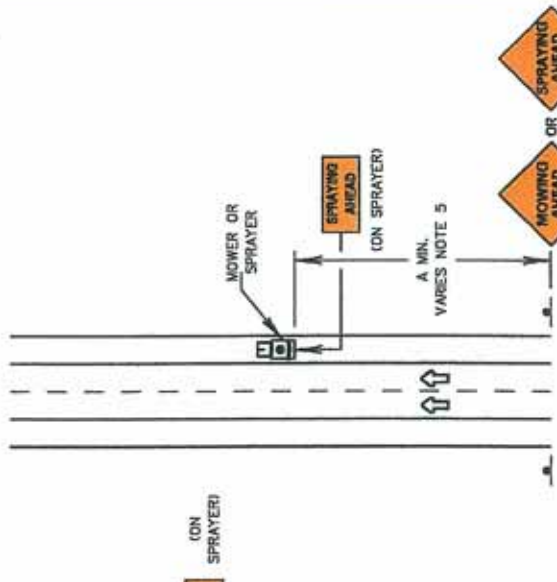

D. MOWING OR SPRAYING - NO ENCROACHMENT ON TRAVEL LANES: MULTILANE HIGHWAY OPERATION

GENERAL NOTES

1. ALL WORK VEHICLES WILL BE EQUIPPED WITH ONE ROTATING HIGH INTENSITY AMBER LIGHT, AND THE SLOW MOVING TRIANGLE MOUNTED ON THE REAR OF THE VEHICLE. THIS APPLIES TO ALL CASES DURING DAY TIME OPERATIONS.
2. WHERE THE SHOULDER AREA TO BE MOWED OR SPRAYED PERMITS, 48" X 48" WARNING SIGNS SHOULD BE USED IN LIEU OF 36" X 36" SIGNS. THE OTHER SIGNS SHALL BE 54" X 30".
3. WHERE PRACTICAL AND WHEN NEEDED, THE WORK AND PROTECTION VEHICLES SHOULD PULL OVER PERIODICALLY TO ALLOW TRAFFIC TO PASS. IF THIS CANNOT BE DONE FREQUENTLY, A "DO NOT PASS" SIGN MAY BE PLACED ON THE TRAIL VEHICLE INSTEAD OF "PASS WITH CARE". THE TRAIL VEHICLE WILL NORMALLY MAINTAIN VISUAL CONTACT WITH THE WORK VEHICLE (APPROXIMATELY 500 FT.) EXCEPT ON CURVES, IN WHICH CASE THE TRAIL VEHICLE WILL DROP BACK FURTHER SO THAT APPROACHING TRAFFIC WILL SEE THAT THEIR LANE IS BLOCKED.
4. ON LOW TRAFFIC VOLUME ROADS WITH LOWER OPERATING SPEEDS, THE SUPERVISOR MAY USE DETAIL A ABOVE AT HIS DISCRETION EVEN THOUGH THERE ARE SOME TRAVEL LANE ENCROACHMENTS.
5. MAXIMUM DISTANCE TO BE MOWED OR SPRAYED WITHIN THE SIGNS SHALL BE WHICHEVER IS LESS: 1/2 DAYS MOWING, 3 MILES ON 2 LANES, OR 5 MILES ON MULTILANES.
6. FOR MEDIAN DIVIDED HIGHWAYS, THE SHOULDER SIGNS SHALL BE PLACED ON BOTH THE RIGHT AND LEFT SIDE OF ROADWAY EVEN THOUGH THE MOWER OR SPRAYER MAY ONLY BE ON ONE SIDE.

TYPICAL APPLICATION

MOWING OPERATION
SPRAYING OPERATION

SUGGESTED ADVANCE WARNING SIGN SPACING

ROAD TYPE	DISTANCE BETWEEN SIGNS (IN FT)		
	A	B	C
URBAN (LOW SPEED)*	100	100	100
URBAN (HIGH SPEED)*	350	350	350
RURAL	500	500	600
EXPRESSWAY/FREEWAY	1,000	1,500	2,040

*SPEED CATEGORY TO BE DETERMINED BY WV DOH

CASE A15

TWO-WAY, TWO-LANE TRAFFIC
DAY OPERATION ONLY
MOWING OPERATION

WHERE, AT ANY TIME, ANY VEHICLE, EQUIPMENT, WORKERS OR THEIR ACTIVITIES REQUIRE AN INTERMITTENT OR CONTINUOUS MOVING OPERATION ON THE SHOULDER

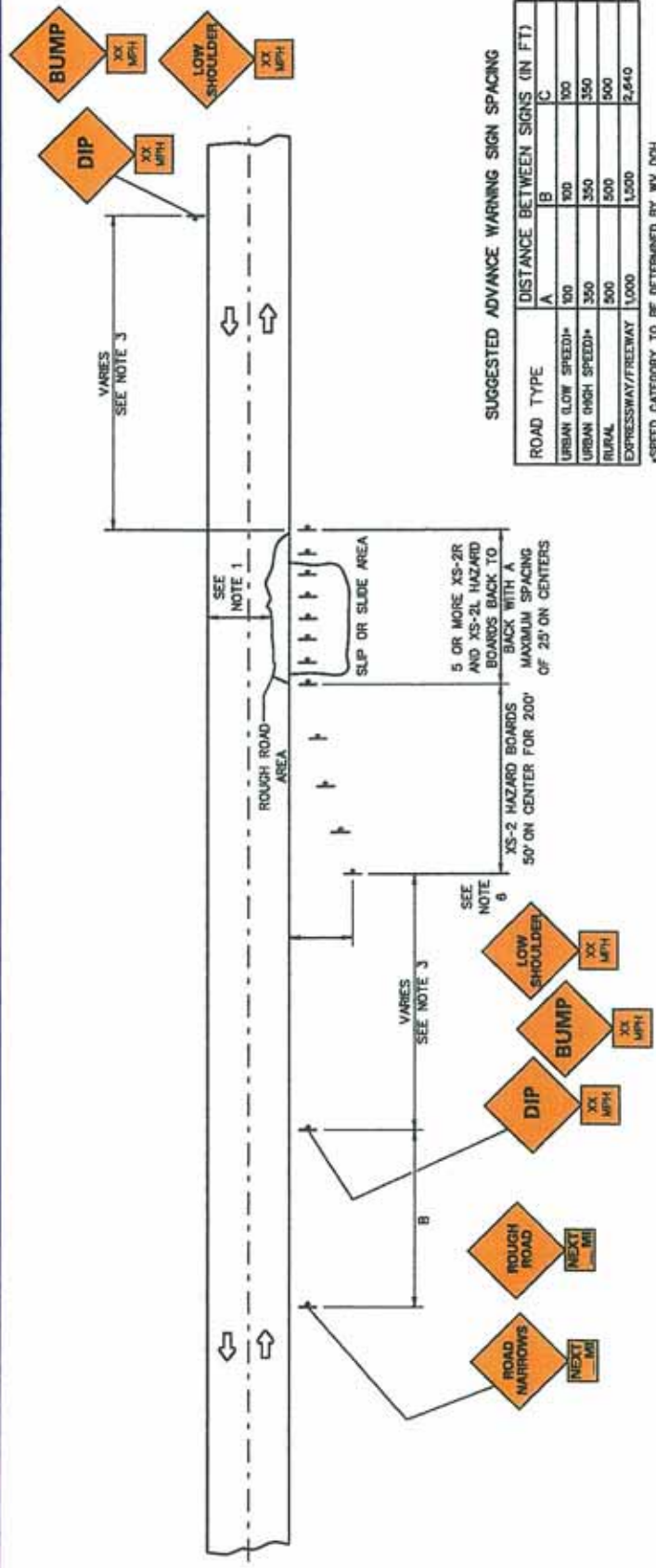

GENERAL NOTES

1. WHEN CONDITIONS REQUIRE THAT ONE LANE TRAFFIC OPERATE, CASE A16 OR CASE A17 SHALL APPLY. ALSO A 16' MINIMUM ROADWAY WIDTH IS REQUIRED. IF WIDTH IS LESS THAN 16' THEN CASE A10 OR CASE A11 APPLIES.
2. WHEN A SERIES OF SLIPS AND SLIDES ARE PRESENT ON A ROADWAY, THE ROUGH ROAD SIGN CAN BE USED WITH A PLAQUE SHOWING THE LENGTH OF ROADWAY UNDER THESE CONDITIONS. ROAD NARROWS SIGN MAY BE SUBSTITUTED FOR ROUGH ROAD SIGN WHEN CONDITIONS WARRANT.
3. THE DISTANCE IN ADVANCE OF THE SLIDE OR SLIP TO BE USED FOR THE PLACEMENT OF THE WARNING SIGN IS RELATED TO THE APPROACH SPEED AND THE ADVISORY SPEED THROUGH THE SLIDE OR SLIP AREA. THE FOLLOWING CHART IS TO BE USED TO FIND THE MINIMUM DISTANCE TO THE WARNING SIGN.
4. IF CONDITIONS EXIST IN BOTH LANES OR ON BOTH SIDES OF ROADWAY, THE HAZARD BOARDS (XS-2) SHALL BE INSTALLED ON BOTH SIDES OF ROADWAY.
5. THE ADVISORY SPEED THROUGH THE AREA SHOULD BE DETERMINED BY TEST RUNS THROUGH THE AREA.
6. THE DIP SIGN SHALL BE USED FOR A DEPRESSION. THE BUMP SIGN SHALL BE USED FOR A SHARP RISE IN THE PAVEMENT. THE LOW SHOULDER SIGN SHALL BE USED WHEN SHOULDER AREA IS LOWER THAN THE PAVEMENT CREATING A HAZARDOUS CONDITION OTHER THAN A DIP OR BUMP.
7. FLASHING WARNING LIGHTS AND/OR FLAGS MAY BE USED TO CALL ATTENTION TO THE ABOVE WARNING SIGNS, AS NEEDED ON THE PLANS, AND/OR AS DIRECTED BY THE ENGINEER.

SPEED REDUCTION M.P.H.	DISTANCE TO WARNING SIGN FEET (MIN.)
10	250
15	275
20	300
25	325
30	350
35	375
40	425
45	500
50	550

TYPICAL APPLICATIONS

- SLIP AREA
- SLIDE AREA
- LOW SHOULDER

CASE A16

TWO-LANE, TWO-WAY TRAFFIC
DAY OR NIGHT OPERATION

WHERE A SLIP OR SLIDE RESULTS IN CLOSURE OF A SHOULDER AREA, ROADWAY WIDTH IS SUFFICIENT FOR TWO WAY TRAFFIC.

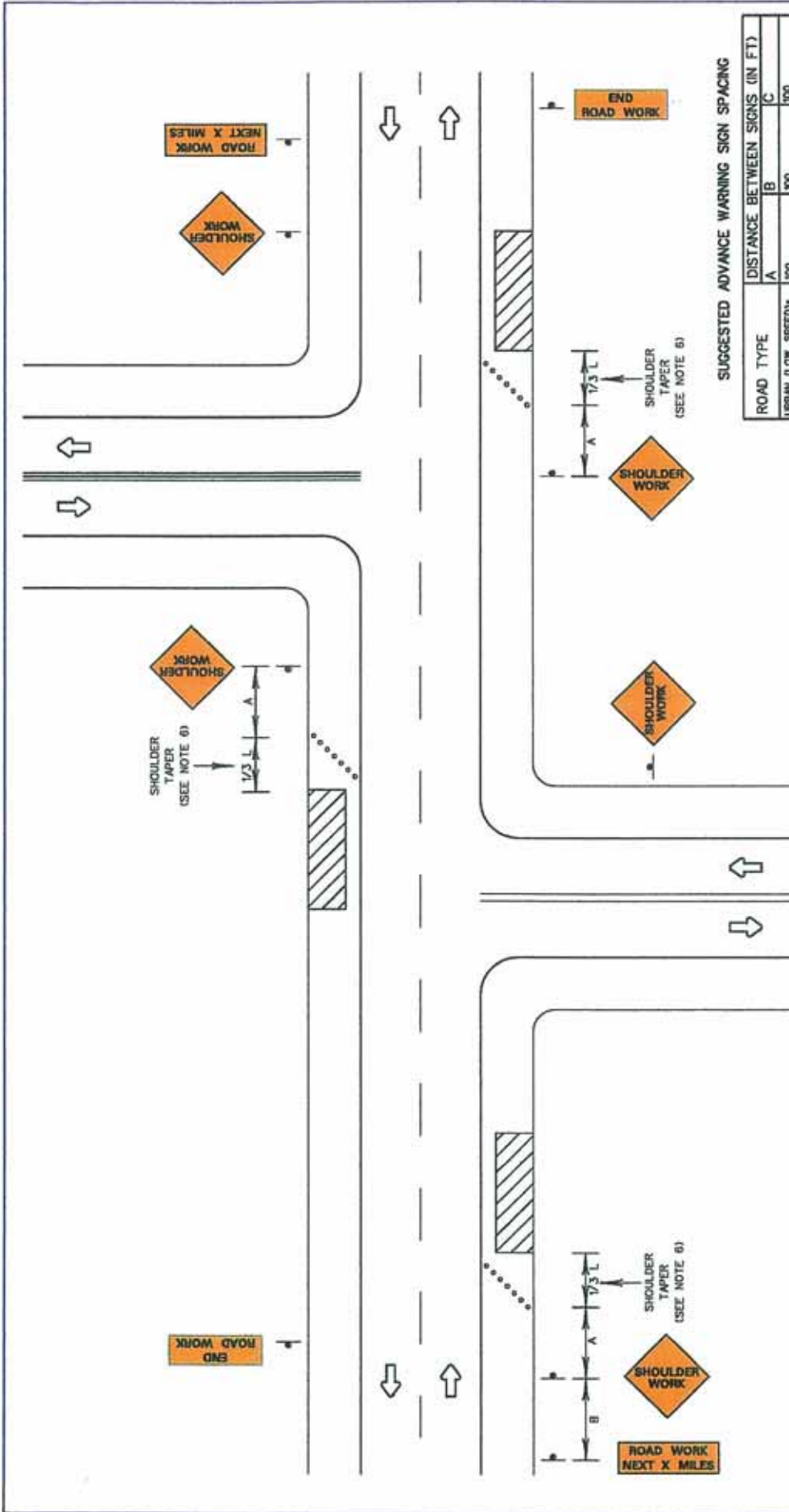

GENERAL NOTES

- ALTHOUGH VEHICLE HAZARD WARNING SIGNALS CAN BE USED TO SUPPLEMENT THE ROTATING LIGHTS OR STROBE LIGHTS, THEY SHALL NOT BE USED INSTEAD OF ROTATING LIGHTS OR STROBE LIGHTS.
- A SHOULDER WORK SIGN SHOULD BE PLACED ON THE LEFT SIDE OF THE ROADWAY FOR A DIVIDED OR ONE-WAY STREET ONLY IF THE LEFT SHOULDER IS AFFECTED.
- THE WORKERS SYMBOL SIGNS MAY BE USED INSTEAD OF SHOULDER WORK SIGNS.
- THE "SHOULDER WORK AHEAD" SIGN ON AN INTERSECTING ROADWAY MAY BE OMITTED WHERE DRIVER EMERGING FROM THAT ROADWAY WILL ENCOUNTER ANOTHER ADVANCE WARNING SIGN PRIOR TO THIS ACTIVITY AREA.
- FOR SHORT-DURATION OPERATIONS OF 60 MINUTES OR LESS, ALL SIGNS AND CHANNELIZING DEVICES MAY BE ELIMINATED IF A VEHICLE WITH ACTIVATED ROTATING LIGHTS OR STROBE LIGHTS IS USED.
- WHEN PAVED SHOULDERS HAVING A WIDTH OF 8 FT OR MORE ARE CLOSED, AT LEAST ONE ADVANCE WARNING SIGN SHALL BE USED. IN ADDITION, CHANNELIZING DEVICES SHALL BE USED TO CLOSE THE SHOULDER IN ADVANCE TO DELINEATE THE BEGINNING OF THE WORK SPACE AND DIRECT VEHICULAR TRAFFIC TO REMAIN WITHIN THE TRAVELED WAY.

SUGGESTED ADVANCE WARNING SIGN SPACING

ROAD TYPE	DISTANCE BETWEEN SIGNS (IN FT)		
	A	B	C
URBAN (LOW SPEED)*	100	100	100
URBAN (HIGH SPEED)*	350	350	350
RURAL	500	500	500
EXPRESSWAY/FREEWAY	1,000	1,500	2,440

*SPEED CATEGORY TO BE DETERMINED BY WY DOH

SPEED	L-TAPER (IN FEET)
25	125
30	180
35	250
40	320
45	540
50	600
55	680

TYPICAL APPLICATIONS

SHOULDER WORK

CASE A17

TWO LANE, TWO WAY TRAFFIC
DAY OR NIGHT OPERATIONS
SHOULDER WORK

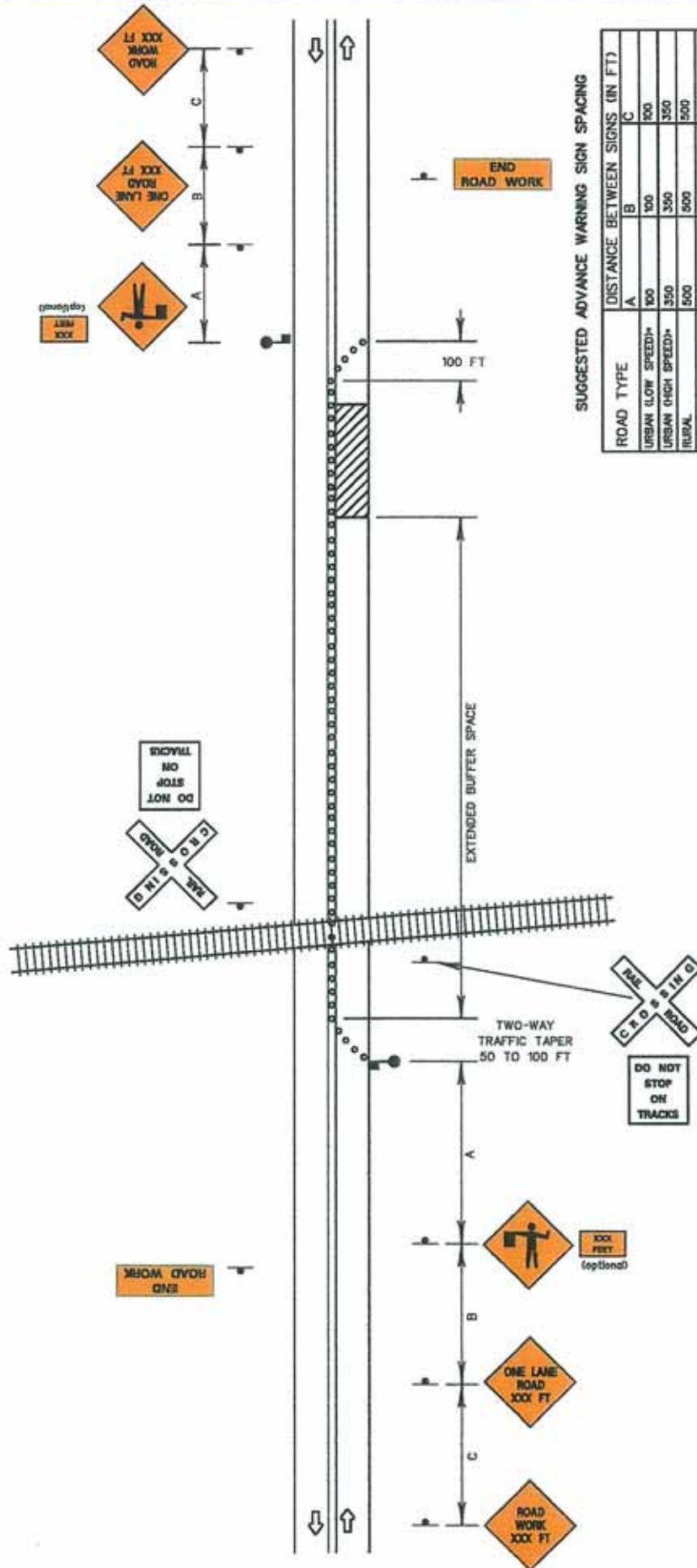

SUGGESTED ADVANCE WARNING SIGN SPACING

ROAD TYPE	DISTANCE BETWEEN SIGNS (IN FT)		
	A	B	C
URBAN (LOW SPEED)*	100	100	100
URBAN (HIGH SPEED)*	350	350	350
RURAL	500	500	500
EXPRESSWAY/FREEWAY	1,000	1,500	2,640

*SPEED CATEGORY TO BE DETERMINED BY WV DOH

GENERAL NOTES

1. WHEN HIGHWAY-RAIL GRADE CROSSINGS EXIST EITHER WITHIN OR IN THE VICINITY OF ROADWAY WORK ACTIVITIES, EXTRA CARE SHOULD BE TAKEN TO MINIMIZE THE PROBABILITY OF CONDITIONS BEING CREATED, EITHER BY LANE RESTRICTIONS, FLAGGING OR OTHER OPERATIONS, WHERE VEHICLES MIGHT BE STOPPED WITHIN THE HIGHWAY-RAIL GRADE CROSSING, CONSIDERED AS BEING 15 FT ON EITHER SIDE OF THE CLOSEST AND FARTHEST RAIL.
2. IF THE QUEUING OF VEHICLES ACROSS ACTIVE RAIL TRACKS CANNOT BE AVOIDED, A LAW ENFORCEMENT OFFICER OR FLAGGER SHALL BE PROVIDED AT THE HIGHWAY-RAIL GRADE CROSSING TO PREVENT VEHICLES FROM STOPPING WITHIN THE HIGHWAY-RAIL GRADE CROSSING (AS DESCRIBED IN NOTE 1), EVEN IF AUTOMATIC WARNING DEVICES ARE IN PLACE.
3. EARLY COORDINATION WITH THE RAILROAD COMPANY SHOULD OCCUR BEFORE WORK STARTS.
4. IN THE EXAMPLE DEPICTED, THE BUFFER SPACE OF THE ACTIVITY AREA SHOULD BE EXTENDED UPSTREAM OF THE HIGHWAY-RAIL GRADE CROSSING (AS SHOWN) SO THAT A QUEUE CREATED BY THE FLAGGING OPERATION WILL NOT EXTEND ACROSS THE HIGHWAY-RAIL GRADE CROSSING.
5. THE "DO NOT STOP ON TRACKS" SIGN SHOULD BE USED ON ALL APPROACHES TO A HIGHWAY-RAIL GRADE CROSSING WITHIN THE LIMITS OF A TEMPORARY TRAFFIC CONTROL ZONE.
6. FLASHING WARNING LIGHTS AND/OR FLAGS MAY BE USED TO CALL ATTENTION TO THE ADVANCE WARNING SIGNS, AS NOTED ON THE PLANS, AND/OR AS DIRECTED BY THE ENGINEER.
7. A "BE PREPARED TO STOP" SIGN MAY BE ADDED TO THE SIGN SERIES.
8. WHEN USED, THE "BE PREPARED TO STOP" SIGN SHOULD BE LOCATED BEFORE THE FLAGGER SYMBOL SIGN.
9. LIGHTING SHOULD BE PROVIDED AS NEEDED TO ADEQUATELY ILLUMINATE FLAGGER STATIONS AT NIGHT.

TYPICAL APPLICATIONS

- PAVEMENT REPAIR
- UTILITY OPERATIONS

CASE A18

TWO-LANE, TWO-WAY TRAFFIC.
DAY OR NIGHT OPERATIONS
ON-NIGHTTIME ONLY IF APPROVED
BY THE ENGINEER.

WORK IN VICINITY OF
HIGHWAY - RAIL GRADE CROSSING

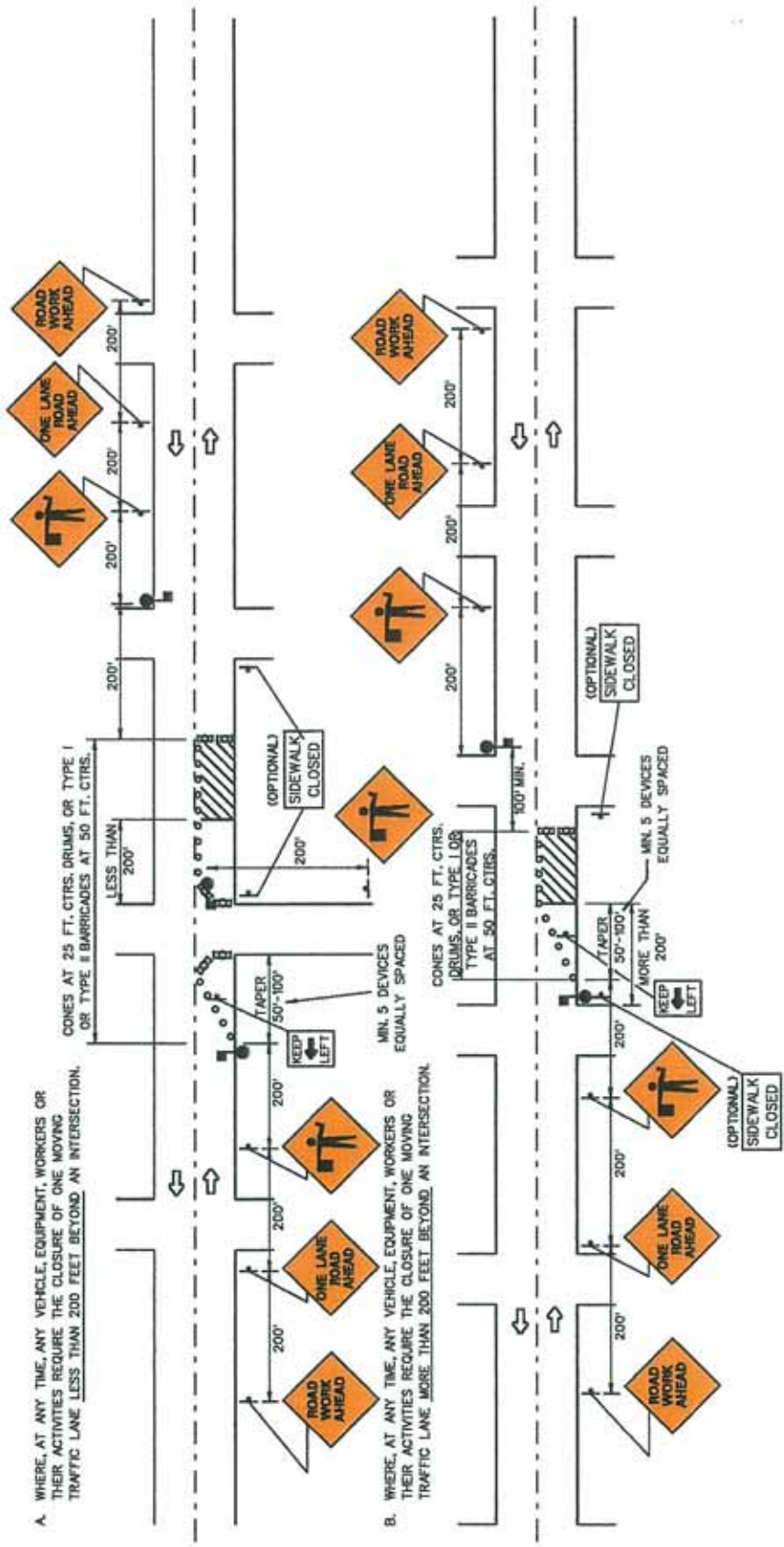

A. WHERE, AT ANY TIME, ANY VEHICLE, EQUIPMENT, WORKERS OR THEIR ACTIVITIES REQUIRE THE CLOSURE OF ONE MOVING TRAFFIC LANE LESS THAN 200 FEET BEYOND AN INTERSECTION.

B. WHERE, AT ANY TIME, ANY VEHICLE, EQUIPMENT, WORKERS OR THEIR ACTIVITIES REQUIRE THE CLOSURE OF ONE MOVING TRAFFIC LANE MORE THAN 200 FEET BEYOND AN INTERSECTION.

SYMBOLS

- TYPE I OR TYPE II BARRICADES WITH FLASHING LIGHT (TYPE "A").
- WORK AREA.
- SIGN
- CONES OR DRUMS (TYPE II BARRICADES OPTIONAL).
- SIGN ON PORTABLE OR PERMANENT SUPPORT.
- FLAGGER WITH PADDLE.

GENERAL NOTES

1. DRUMS OR TYPE II BARRICADES SHALL BE USED IN LIEU OF CONES FOR NIGHT OPERATIONS.
2. IF THE WORK OPERATION PERFORMED DOES NOT EXCEED 15 MINUTES, SIGNING SHALL BE IN CONFORMANCE WITH CASE A8.
3. WHERE THE WORK AREA EXTENDS THROUGH THE INTERSECTION, BARRICADES AND/OR ADEQUATE WARNING SIGNS SHALL BE ERECTED ON THE CROSS STREET.
4. IF THE WORK AREA IS IN THE PARKING LANE A ROAD WORK AHEAD SIGN SHALL BE INSTALLED 200 FT. IN ADVANCE OF THE WORK AREA AND THE WORK AREA PROTECTED WITH CONES, DRUMS OR BARRICADES.
5. CONSTRUCTION OPERATIONS SHALL BE CONFINED TO ONE TRAFFIC LANE, LEAVING THE OPPOSITE LANE OPEN TO TRAFFIC. AT LEAST 500 FT. OF BOTH TRAFFIC LANES SHALL BE AVAILABLE FOR TRAFFIC MOVEMENT AT INTERVALS NOT GREATER THAN 1,000 FT.
6. THE FLAGGERS SHALL BE IN SIGHT OF EACH OTHER OR IN DIRECT COMMUNICATION AT ALL TIMES.
7. ALL SIGNS SHALL BE POST MOUNTED IF THE CLOSURE TIME EXCEEDS THREE DAYS.
8. FLASHING WARNING LIGHTS AND/OR FLAGS MAY BE USED TO CALL ATTENTION TO THE ABOVE WARNING SIGNS, AS NEEDED ON THE PLANS, AND/OR AS DIRECTED BY THE ENGINEER.
9. ALL VEHICLES, EQUIPMENT, WORKERS (EXCEPT FLAGGERS) AND THEIR ACTIVITIES ARE RESTRICTED AT ALL TIMES TO ONE SIDE OF THE PAVEMENT UNLESS OTHERWISE AUTHORIZED BY THE ENGINEER.

CASE B1

TWO-LANE, TWO-WAY TRAFFIC UNDIVIDED, URBAN, LOW-VOLUME, LOW-SPEED DAY OR NIGHT OPERATIONS

WHERE, AT ANY TIME, ANY VEHICLE EQUIPMENT, WORKERS OR THEIR ACTIVITIES ENCROACH ON THE PAVEMENT REQUIRING THE CLOSURE OF ONE TRAFFIC LANE.

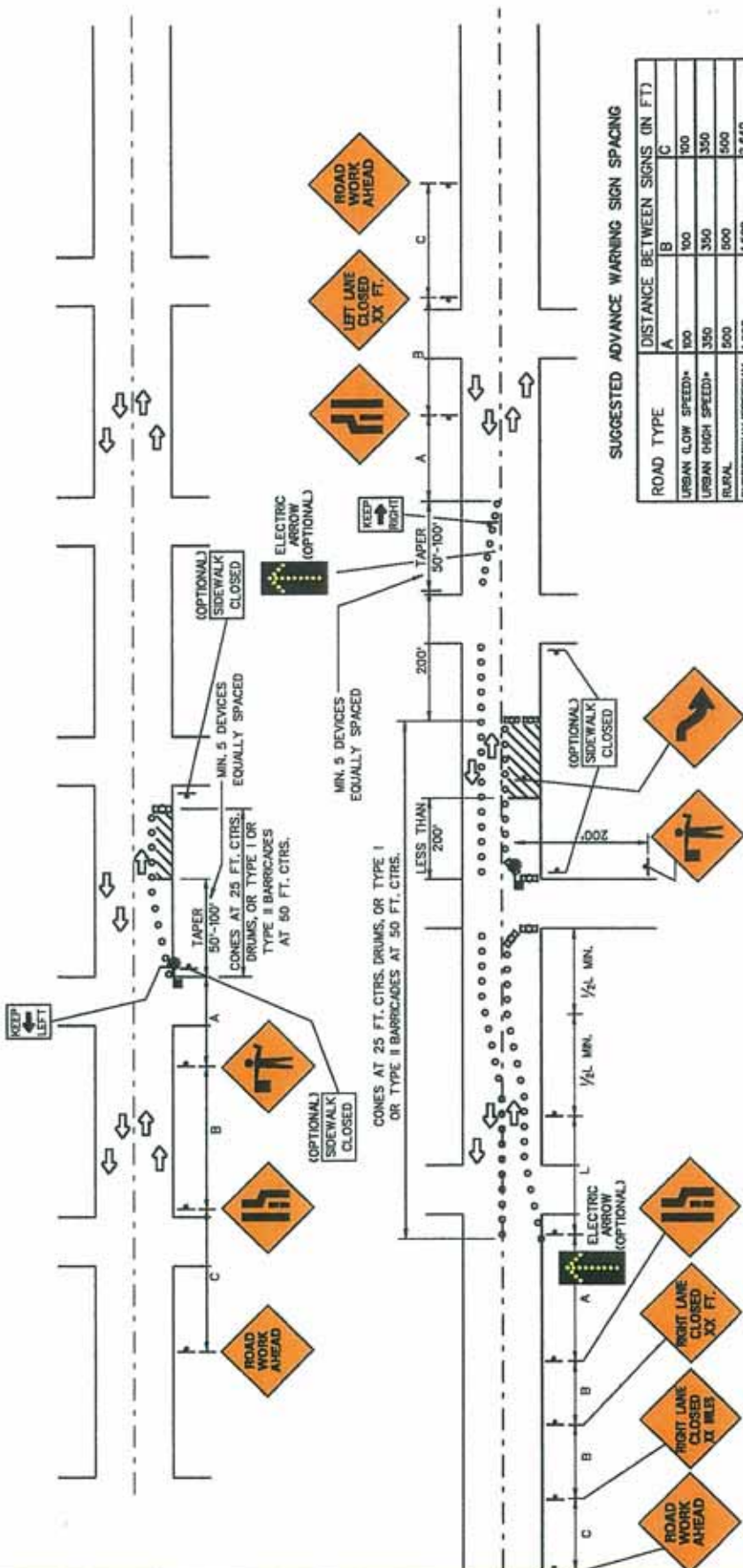

SUGGESTED ADVANCE WARNING SIGN SPACING

ROAD TYPE	A	B	C
URBAN (LOW SPEED)*	100	100	100
URBAN (HIGH SPEED)*	350	350	350
RURAL	800	800	800
EXPRESSWAY/FREEWAY	1,000	1,500	2,640

*SPEED CATEGORY TO BE DETERMINED BY WV DOH

SYMBOLS

- TYPE I OR TYPE II BARRICADES WITH FLASHING LIGHT (TYPE "A").
- WORK AREA.
- SIGN.
- CONES OR DRUMS (TYPE II BARRICADES OPTIONAL).
- SIGN ON PORTABLE OR PERMANENT SUPPORT.
- FLAGGER WITH PADDLE.

CASE B2

- MULTILANE TWO WAY TRAFFIC UNDIVIDED URBAN, OR
- MULTILANE TWO WAY TRAFFIC DIVIDED URBAN WITH MOUNTABLE MEDIAN, DAY OR NIGHT OPERATION.
- WHERE, AT ANY TIME, ANY VEHICLE EQUIPMENT, WORKERS OR THEIR ACTIVITIES ENCRoACH ON THE PAVEMENT REQUIRING THE CLOSURE OF AT LEAST ONE TRAFFIC LANE.

GENERAL NOTES

1. DRUMS OR TYPE II BARRICADES SHALL BE USED IN LEU OF CONES FOR NIGHT OPERATIONS.
2. SPEED L-TAPER (IN FEET)

25	125
30	180
35	250
40	320
45	540
50	800
55	860
3. IF THE WORK OPERATION PERFORMED DOES NOT EXCEED 15 MINUTES SIGNING SHALL BE IN CONFORMANCE WITH CASE A6.
4. WHERE THE WORK AREA EXTENDS THROUGH THE INTERSECTION, BARRICADES AND/OR ADEQUATE WARNING SIGNS SHALL BE ERECTED ON THE CROSS STREET.
5. IF THE WORK AREA IS ON THE PARKING LANE A ROAD WORK AHEAD SIGN SHALL BE INSTALLED 200 FT. IN ADVANCE OF THE WORK AREA PROTECTED WITH CONES, DRUMS OR BARRICADES.
6. WHEN THERE IS NO WORK BEING PERFORMED FLAGGER AHEAD SIGNS AND THE FLAGGER WILL NOT BE REQUIRED. ONE LANE ROAD AHEAD SIGNS SHALL BE INSTALLED IN PLACE OF THE FLAGGER AHEAD SIGNS.
7. ALL SIGNS SHALL BE POST MOUNTED IF THE CLOSURE TIME EXCEEDS THREE DAYS.
8. FLASHING WARNING LIGHTS AND/OR FLAGS MAY BE USED TO CALL ATTENTION TO THE ABOVE WARNING SIGNS, AS NEEDED ON THE PLANS, AND/OR AS DIRECTED BY THE ENGINEER.
9. ALL VEHICLES, EQUIPMENT, WORKERS (EXCEPT FLAGGERS) AND THEIR ACTIVITIES ARE RESTRICTED AT ALL TIMES TO ONE SIDE OF THE PAVEMENT UNLESS OTHERWISE AUTHORIZED BY THE ENGINEER.
10. WHERE PARKED VEHICLES BLOCK THE LINE OF SIGHT TO NORMAL SIGN LOCATIONS, OR SIGNS ENCRoACH ON A NORMAL PEDESTRIAN WALKWAY, THE SIGNS SHALL BE POST MOUNTED WITH THE BOTTOM NOT LESS THAN 7 FT. ABOVE THE EDGE OF THE ROADWAY.

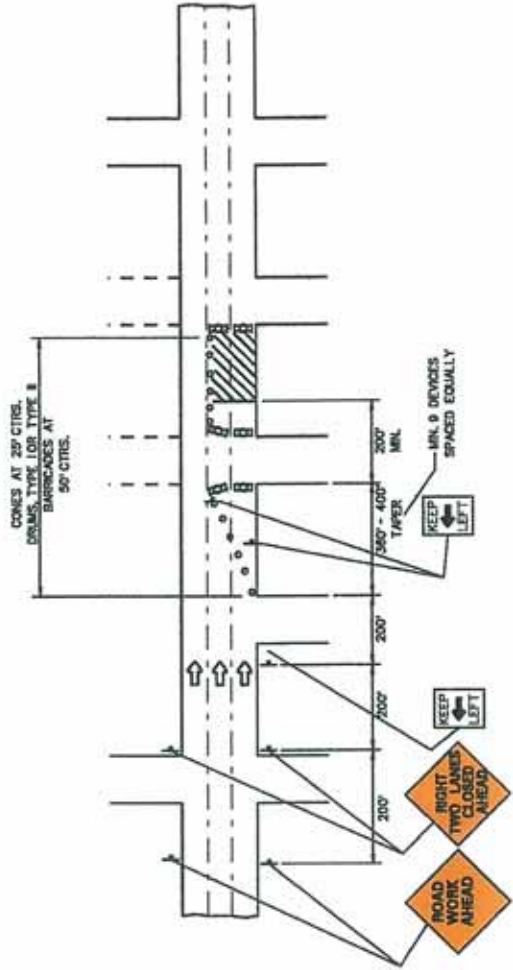
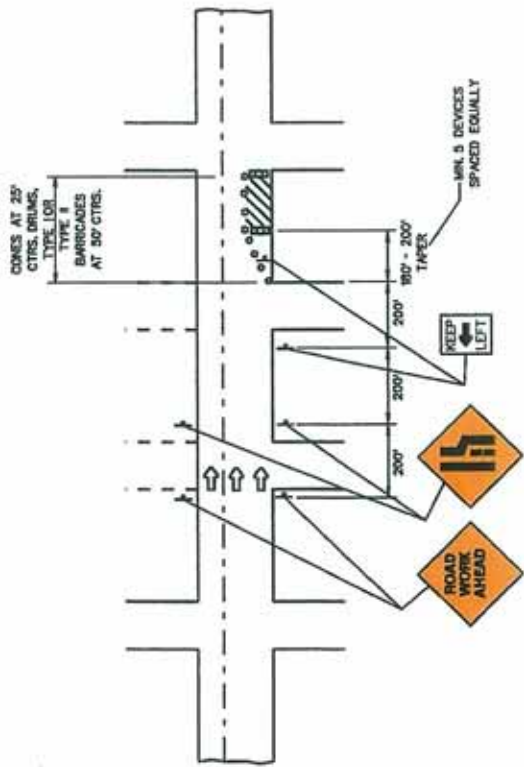

GENERAL NOTES

1. DRUMS OR TYPE II BARRICADES WITH TYPE "C" LIGHTS SHALL BE USED IN LIEU OF CONES FOR NIGHT OPERATIONS.
2. IF THE WORK OPERATION PERFORMED DOES NOT EXCEED 15 MINUTES, SIGNING SHALL BE IN ACCORDANCE WITH CASE A6.
3. WHERE THE WORK AREA EXTENDS THROUGH THE INTERSECTION, BARRICADES AND/OR ADEQUATE WARNING SIGNS SHALL BE ERECTED ON THE CROSS STREET.
4. IF THE WORK AREA IS IN THE PARKING LANE A ROAD WORK AHEAD SIGN SHALL BE INSTALLED 200 FT. IN ADVANCE OF THE WORK AREA AND THE WORK AREA PROTECTED WITH CONES, DRUMS OR BARRICADES.
5. THIS CASE ALSO APPLIES WHEN WORK IS BEING PERFORMED IN THE EXTREME LEFT LANE OR LANES. UNDER THESE CONDITIONS THE APPROPRIATE PAVEMENT WIDTH TRANSITION SIGN SHALL BE USED, AND KEEP RIGHT SIGNS SUBSTITUTED FOR THE KEEP LEFT SIGNS.
6. ALL SIGNS SHALL BE POST MOUNTED IF THE CLOSURE TIME EXCEEDS THREE DAYS.
7. ALL VEHICLES, EQUIPMENT, WORKERS OR THEIR ACTIVITIES ARE RESTRICTED AT ALL TIMES TO ONE SIDE OF THE PAVEMENT UNLESS OTHERWISE AUTHORIZED BY THE ENGINEER.
8. FLASHING WARNING LIGHTS AND/OR FLAGS MAY BE USED TO CALL ATTENTION TO THE ABOVE WARNING SIGNS, AS NEEDED ON THE PLANS, AND/OR AS DIRECTED BY THE ENGINEER.

SYMBOLS

- ▩ TYPE I OR TYPE II BARRICADES WITH FLASHING LIGHT (TYPE "K").
- ▨ WORK AREA.
- ◇ SIGN.
- CONES OR DRUMS (TYPE II BARRICADES OPTIONAL).
- † SIGN ON PORTABLE OR PERMANENT SUPPORT.

CASE B3A

MULTILANE, ONE WAY TRAFFIC WITH NON TRAVERSABLE MEDIAN, OR MULTILANE ONE WAY TRAFFIC, URBAN, DAY OR NIGHT OPERATION.
 WHERE, AT ANY TIME, ANY VEHICLE, EQUIPMENT, WORKERS OR THEIR ACTIVITIES ENDOURCH ON THE PAVEMENT REQUIRING THE CLOSURE OF ONE OR MORE TRAFFIC LANES.

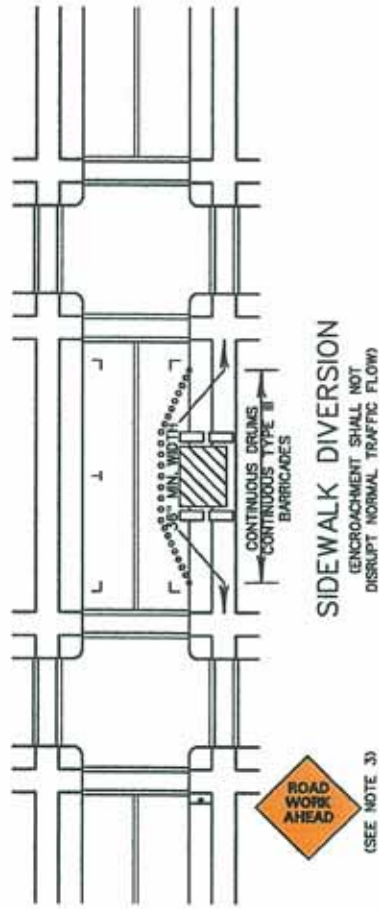
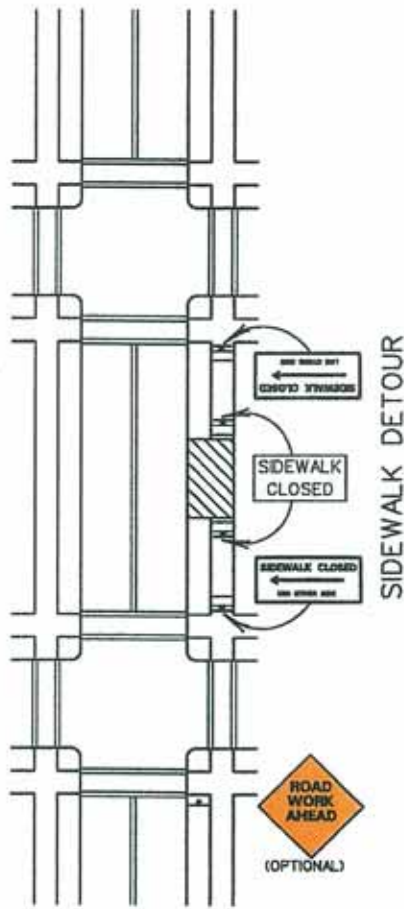

GENERAL NOTES

1. WHEN CROSSWALKS OR OTHER PEDESTRIAN FACILITIES ARE CLOSED OR RELOCATED, TEMPORARY FACILITIES SHALL BE DETECTABLE AND SHALL INCLUDE ACCESSIBILITY FEATURES CONSISTENT WITH THE FEATURES PRESENT IN THE EXISTING PEDESTRIAN FACILITY.
2. WHERE HIGH SPEEDS ARE ANTICIPATED, A TEMPORARY TRAFFIC BARRIER AND, IF NECESSARY, A CRASH CUSHION SHOULD BE USED TO SEPARATE THE TEMPORARY SIDEWALKS FROM VEHICULAR TRAFFIC.
3. ONLY THE TEMPORARY TRAFFIC CONTROL DEVICES RELATED TO PEDESTRIANS ARE SHOWN. OTHER DEVICES, SUCH AS LANE CLOSURE SIGNING OR ROAD NARROWS SIGNS, MAY BE USED TO CONTROL MOTOR VEHICLE TRAFFIC.
4. FOR NIGHTTIME CLOSURES, TYPE A FLASHING WARNING LIGHTS MAY BE USED ON BARRICADES THAT SUPPORT SIGNS AND CLOSE SIDEWALKS.
5. TYPE C STEADY-BURN WARNING LIGHTS MAY BE USED ON CHANNELIZING DEVICES SEPARATING THE TEMPORARY SIDEWALKS FROM VEHICULAR TRAFFIC FLOW.
5. SIGNS, SUCH AS KEEP RIGHT (LEFT), MAY BE PLACED ALONG A TEMPORARY SIDEWALK TO GUIDE OR DIRECT PEDESTRIANS.

CASE B3B
SIDEWALK DETOUR OR
SIDEWALK DIVERSION

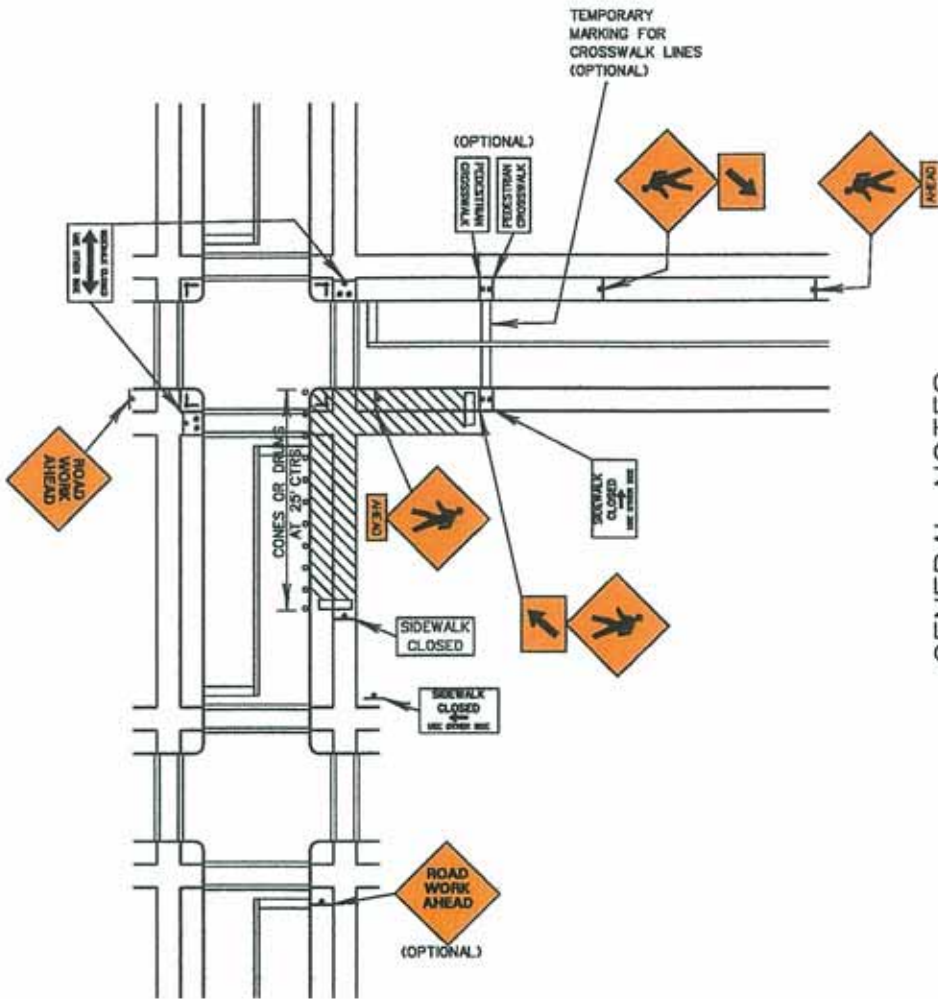

GENERAL NOTES

1. WHEN CROSSWALKS OR OTHER PEDESTRIAN FACILITIES ARE CLOSED OR RELOCATED, TEMPORARY FACILITIES SHALL BE DETECTABLE AND SHALL INCLUDE ACCESSIBILITY FEATURES CONSISTENT WITH THE FEATURES PRESENT IN THE EXISTING PEDESTRIAN FACILITY.
2. CURB PARKING SHALL BE PROHIBITED FOR AT LEAST 50 FT. IN ADVANCE OF THE MIDDLEBLOCK CROSSWALK.
3. PEDESTRIAN TRAFFIC SIGNAL DISPLAYS CONTROLLING CLOSED CROSSWALKS SHOULD BE COVERED OR DEACTIVATED.
4. ONLY THE TEMPORARY TRAFFIC CONTROL DEVICES RELATED TO PEDESTRIANS ARE SHOWN. OTHER DEVICES, SUCH AS LANE CLOSURE SIGNING OR ROAD NARROWS SIGNS, MAY BE USED TO CONTROL MOTOR VEHICLE TRAFFIC.
5. FOR NIGHTTIME CLOSURES, TYPE A FLASHING WARNING LIGHTS MAY BE USED ON BARRICADES SUPPORTING SIGNS AND CLOSING SIDEWALKS.
6. TYPE C STEADY-BURN WARNING LIGHTS MAY BE USED ON CHANNELIZING DEVICES SEPARATING THE WORK SPACE FROM VEHICULAR TRAFFIC.

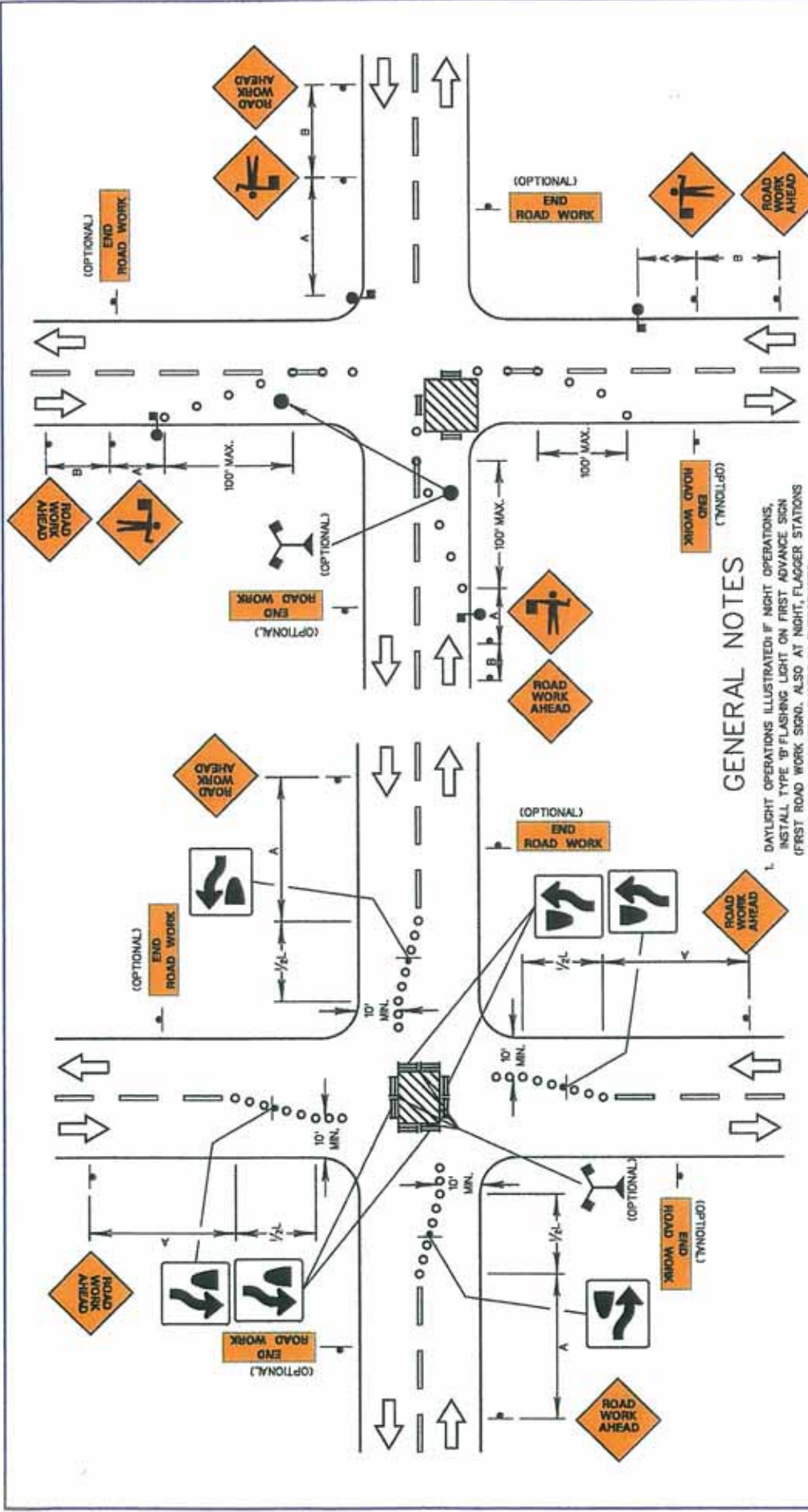

GENERAL NOTES

1. DAYLIGHT OPERATIONS ILLUSTRATED; IF NIGHT OPERATIONS, INSTALL TYPE 'B' FLASHING LIGHT ON FIRST ADVANCE SIGN (FIRST ROAD WORK SIGN). ALSO AT NIGHT, FLAGGER STATIONS SHALL BE ILLUMINATED, EXCEPT IN EMERGENCIES.

2. SPEED	L-TAPER (IN FEET)
25	125
30	150
35	180
40	250
45	320
50	400
55	500
60	600
65	750
70	900
75	1,050
80	1,200
85	1,350
90	1,500
95	1,650
100	1,800

SYMBOLS

- WORK AREA
- TYPE B BARRICADE DAY OPERATIONS
- TYPE B BARRICADE NIGHT OPERATIONS WITH FLASHING LIGHT (TYPE 'A')
- SIGN ON PORTABLE OR PERMANENT SUPPORT.
- FLAGGER WITH PADDLE
- CONES OR DRUMS (AT 25 FT. CENTERS OR LESS)
- HIGH LEVEL WARNING DEVICE (FLAG TREE)

SUGGESTED ADVANCE WARNING SIGN SPACING

ROAD TYPE	DISTANCE BETWEEN SIGNS (IN FT)		
	A	B	C
URBAN (LOW SPEED)*	100	100	100
URBAN (HIGH SPEED)*	350	350	350
RURAL	500	500	500
EXPRESSWAY/FREEWAY	1,000	1,500	2,000

*SPEED CATEGORY TO BE DETERMINED BY WV DCH

ALL SIGNS SHALL BE POST MOUNTED IF THE CLOSURE TIME EXCEEDS THREE DAYS.

WHEN NO WORK IS BEING PERFORMED, FLAGGER AHEAD SIGNS SHALL BE COVERED OR REMOVED AND ONE LANE ROAD AHEAD SIGNS SUBSTITUTED.

UNLESS THE STREETS ARE WIDE, IT MAY BE PHYSICALLY IMPOSSIBLE TO TURN LEFT ESPECIALLY FOR LARGE VEHICLES. LEFT TURNS MAY BE PROHIBITED AS REQUIRED BY GEOMETRIC CONDITIONS.

CASE B4A

TWO-LANE, TWO-WAY
TRAFFIC, UNDIVIDED
URBAN, LOW-VOLUME, LOW-SPEED
DAY OR NIGHT OPERATIONS

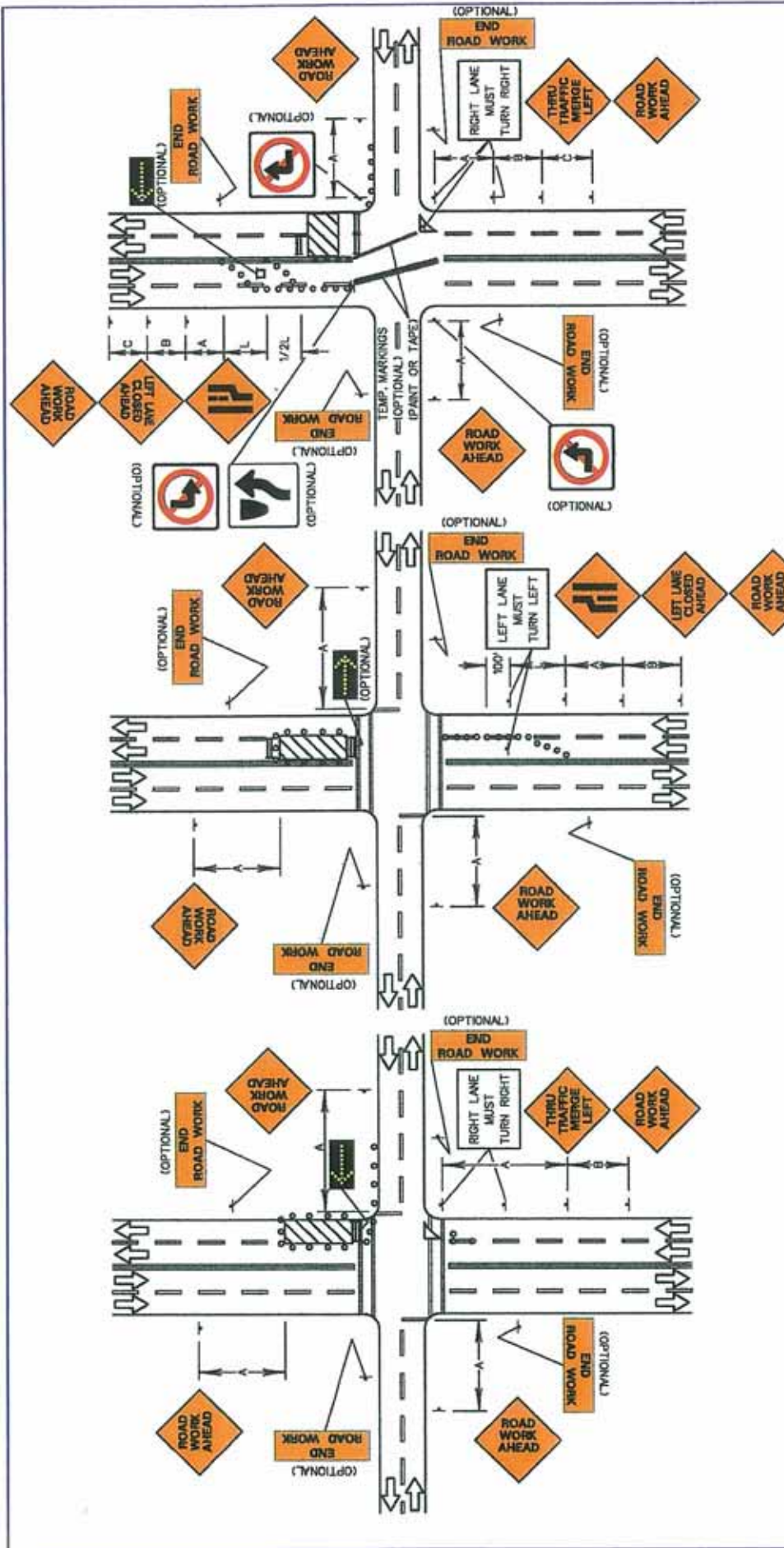

SUGGESTED ADVANCE WARNING SIGN SPACING

ROAD TYPE	A	B	C
URBAN (LOW SPEED)*	100	100	100
URBAN (HIGH SPEED)*	300	300	300
RURAL	500	500	500
EXPRESSWAY/FREEWAY	1000	1500	2,040

*SPEED CATEGORY TO BE DETERMINED BY WY DOT

CASE B4B
 MULTI-LANE, TWO-WAY
 TRAFFIC, UNIDIRECTIONAL
 URBAN DAY OR
 NIGHT OPERATIONS

GENERAL NOTES

- DAYLIGHT OPERATIONS ILLUSTRATED; IF NIGHT OPERATIONS, INSTALL TYPE 'B' FLASHING LIGHT ON FIRST ADVANCE SIGN (FIRST ROAD WORK SIGN).
- SPEED L-TAPER (IN FEET)

25	725
30	190
35	250
40	320
45	540
50	600
55	660
- ALL SIGNS SHALL BE POST MOUNTED IF THE CLOSURE TIME EXCEEDS THREE DAYS.
- IF THE WORK SPACE EXTENDS ACROSS THE CROSSWALK, THE CROSSWALK SHALL BE CLOSED USING APPROPRIATE DEVICES.
- WHEN TURN PROHIBITIONS ARE IMPLEMENTED, TWO TURN PROHIBITION SIGNS SHOULD BE USED, ONE ON THE NEAR SIDE AND, SPACE PERMITTING, ONE ON THE FAR SIDE OF THE INTERSECTION.

SYMBOLS

- WORK AREA.
- TYPE II BARRICADE DAY OPERATIONS
- TYPE III BARRICADE NIGHT OPERATIONS WITH FLASHING LIGHT (TYPE 'A')
- SIGN ON PORTABLE OR PERMANENT SUPPORT.
- FLAGGER WITH PADDLE
- CONES OR DRUMS (AT 25 FT. CENTERS OR LESS)

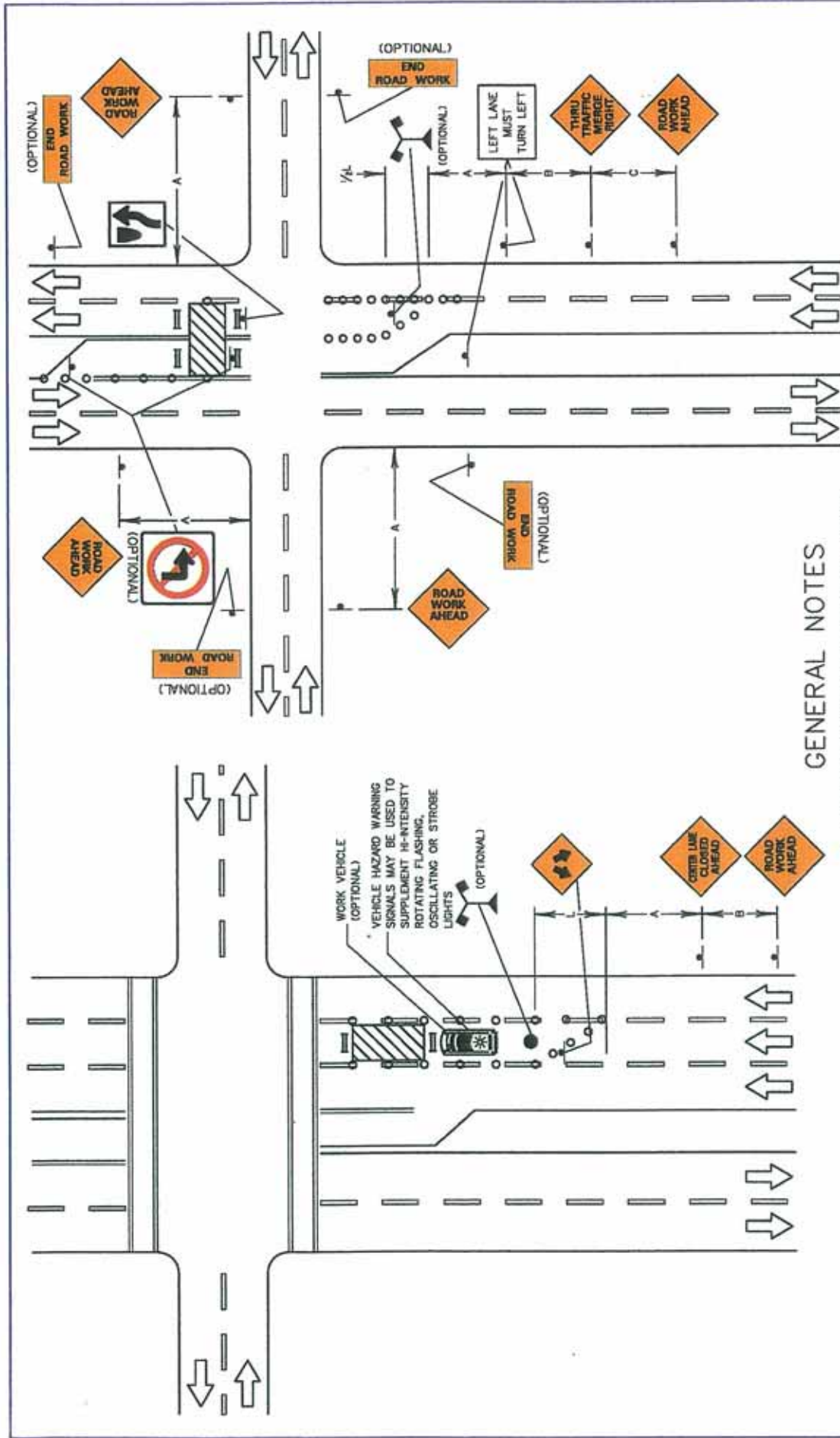

SUGGESTED ADVANCE WARNING SIGN SPACING

ROAD TYPE	DISTANCE BETWEEN SIGNS (IN FT)		
	A	B	C
URBAN LOW SPEED*	300	100	100
URBAN HIGH SPEED**	350	350	350
RURAL	500	500	800
EXPRESSWAY/FREEWAY	1,000	1,500	2,640

*SPEED CATEGORY TO BE DETERMINED BY WV DOH

CASE B4C

MULTI-LANE, TWO-WAY
TRAFFIC, DIVIDED
URBAN DAY OR
NIGHT OPERATIONS

GENERAL NOTES

- DAYLIGHT OPERATIONS ILLUSTRATED; IF NIGHT OPERATIONS, INSTALL TYPE 'B' FLASHING LIGHT ON FIRST ADVANCE SIGN (FIRST ROAD WORK SIGN).
- SPEED L-TAPER (IN FEET)

25	125
30	180
35	250
40	320
45	440
50	600
55	880
- ALL SIGNS SHALL BE POST MOUNTED IF THE CLOSURE TIME EXCEEDS THREE DAYS.
- IF THE WORKSPACE EXTENDS ACROSS THE CROSSWALK, THE CROSSWALK SHOULD BE CLOSED USING THE APPROPRIATE DEVICES.

SYMBOLS

- WORK AREA
- TYPE II BARRICADE DAY OPERATIONS
- TYPE III BARRICADE NIGHT OPERATIONS WITH FLASHING LIGHT (TYPE 'A')
- SIGN ON PORTABLE OR PERMANENT SUPPORT.
- FLAGGER WITH PADDLE
- CONES OR DRUMS (AT 25 FT. CENTERS OR LESS)
- HIGH LEVEL WARNING DEVICE (FLAG TREE)

GENERAL NOTES

1. WHERE WORK AREA EXTENDS THROUGH OTHER INTERSECTIONS, BARRICADES AND/OR ADEQUATE WARNING SIGNS SHALL BE ERRECTED ON THE CROSS STREET.
2. ALL SIGNS SHALL BE POST MOUNTED IF THE DETOUR TIME EXCEEDS SEVEN DAYS.
3. OTHER SPECIAL DESTINATION SIGNS MAY BE NECESSARY AND SHOULD BE IN ACCORDANCE WITH THE D.O.H. SIGN FABRICATION MANUAL.
4. FLASHING WARNING LIGHTS AND/OR FLAGS MAY BE USED TO CALL ATTENTION TO THE ADVANCE WARNING SIGNS AS NOTED ON THE PLANS AND/OR DIRECTED BY THE ENGINEER.
5. FLASHING WARNING LIGHTS MAY BE USED ON THE TYPE II BARRICADES.

CASE B6

TWO WAY TRAFFIC, URBAN,
DAY OR NIGHT OPERATION

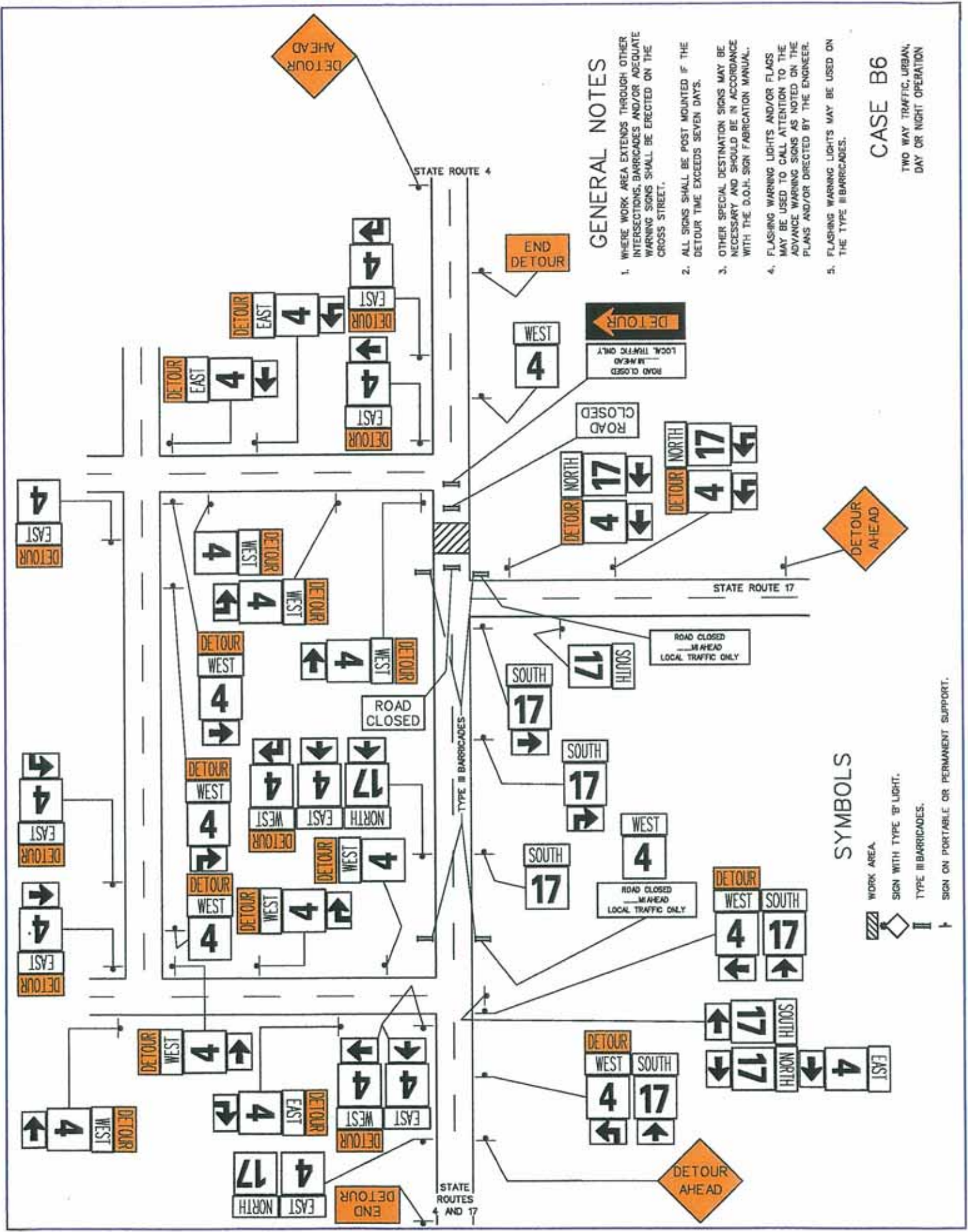

SYMBOLS

- WORK AREA
- SIGN WITH TYPE II LIGHT.
- TYPE II BARRICADES.
- SIGN ON PORTABLE OR PERMANENT SUPPORT.

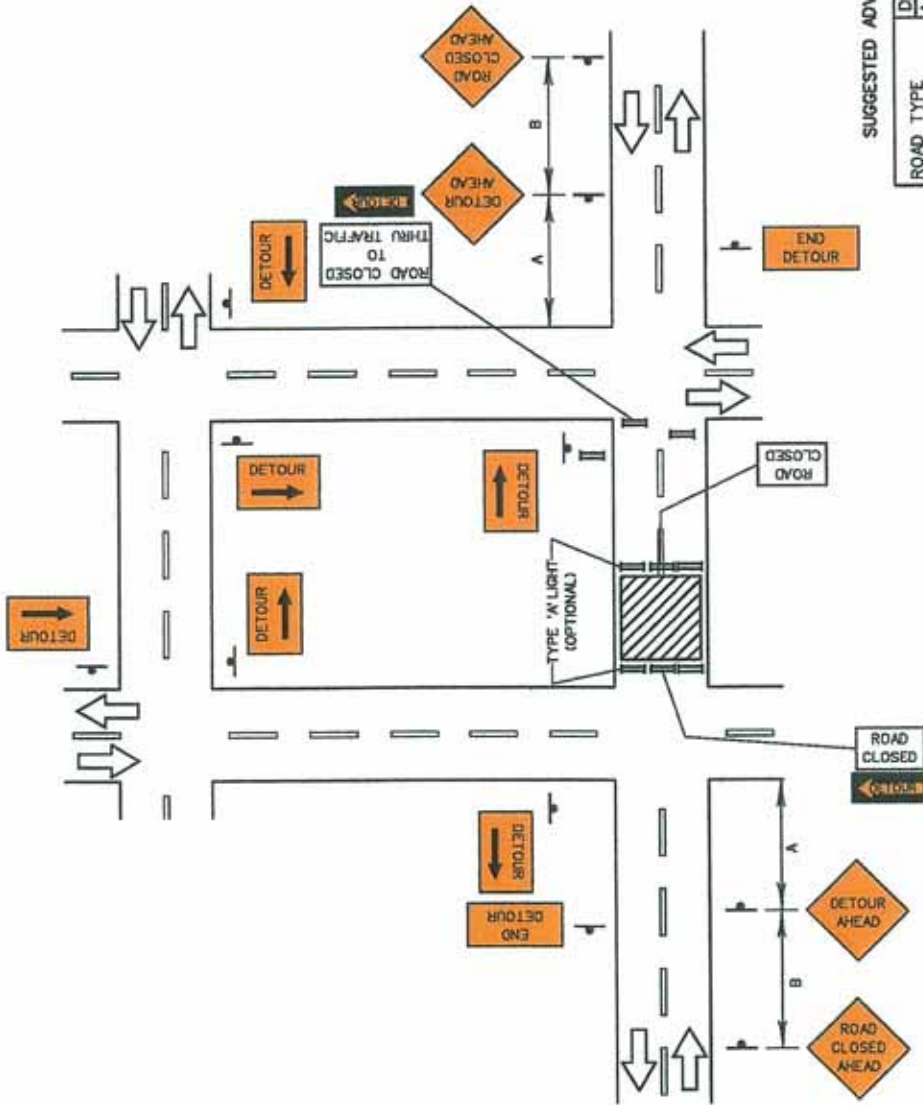

SUGGESTED ADVANCE WARNING SIGN SPACING

ROAD TYPE	DISTANCE BETWEEN SIGNS (IN FT)		
	A	B	C
URBAN (LOW SPEED)*	100	100	100
URBAN (HIGH SPEED)*	350	350	350
RURAL	500	500	500
EXPRESSWAY/FREEWAY	1,000	1,000	2,040

*SPEED CATEGORY TO BE DETERMINED BY NY DOH

GENERAL NOTES

1. GENERALLY USED FOR CITY STREETS.
2. USE OF STREET NAME SIGN (PLATE) OPTIONAL. STREET NAME SIGN MAY BE EITHER BLACK ON ORANGE OR WHITE ON GREEN BUT WHEN USED SHALL BE PLACED ABOVE THE DETOUR SIGN.
3. ALL SIGNS SHALL BE POST MOUNTED IF THE DETOUR TIME EXCEEDS SEVEN DAYS.
5. FLASHING WARNING LIGHTS AND/OR FLAGS MAY BE USED TO CALL ATTENTION TO THE ADVANCE WARNING SIGNS AS NOTED ON THE PLANS AND/OR AS DIRECTED BY THE ENGINEER.
6. FLASHING WARNING LIGHTS MAY BE USED ON TYPE B BARRICADES.

SYMBOLS

- WORK AREA
- SIGN
- TYPE B BARRICADE
- SIGN ON PORTABLE OR PERMANENT SUPPORT.

CASE B7

TWO WAY TRAFFIC, URBAN,
DAY OR NIGHT OPERATION

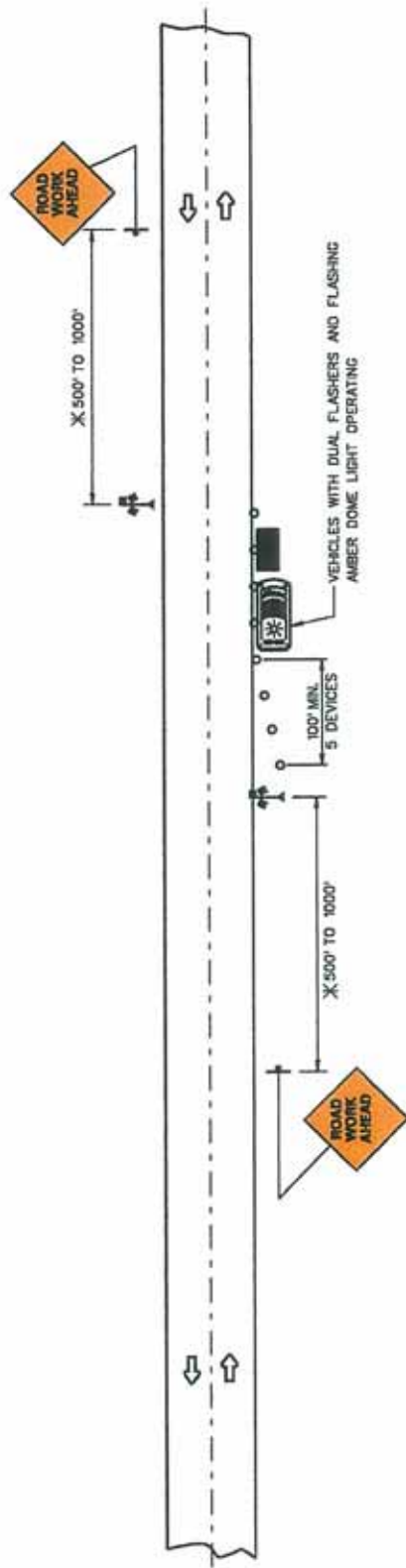

SYMBOLS

-  WORK AREA.
-  SIGN
-  SIGN ON PORTABLE OR PERMANENT SUPPORT.
-  HIGH LEVEL WARNING DEVICE.
-  CONES ON 25' CENTERS MAX.

GENERAL NOTES

1. ROAD WORK AHEAD SIGNS ARE TO BE REMOVED WHEN NO WORK IS BEING PERFORMED. ANY UNATTENDED OBSTACLE OR EXCAVATION IN THE WORK AREA SHALL BE PROTECTED BY TYPE I OR TYPE II BARRICADES WITH FLASHING LIGHTS. (TYPE "A").
2. IF THE WORK OPERATION REQUIRES THAT FOUR OR MORE WORK VEHICLES ENTER THE THROUGH TRAFFIC LANES IN A ONE-HOUR PERIOD A FLAGGER SHALL BE PROVIDED AND THE FLAGGER SIGN SHALL BE ERECTED ACCORDINGLY.
3. ALL VEHICLES, EQUIPMENT, WORKERS (EXCEPT FLAGGERS) AND THEIR ACTIVITIES ARE RESTRICTED AT ALL TIMES TO ONE SIDE OF THE PAVEMENT UNLESS OTHERWISE AUTHORIZED BY THE ENGINEER.

TYPICAL APPLICATIONS

UTILITY OPERATIONS ONLY

CASE C1

TWO-LANE, TWO-WAY TRAFFIC
DAYLIGHT OPERATIONS ONLY

WHERE, AT ANY TIME, ANY VEHICLES, EQUIPMENT, WORKERS OR THEIR ACTIVITIES WILL ENCROACH IN THE AREA BETWEEN 2 FT. AND 15 FT. FROM THE EDGE OF PAVEMENT.

x - MAY BE DECREASED TO 200' TO 350' FOR URBAN AREA

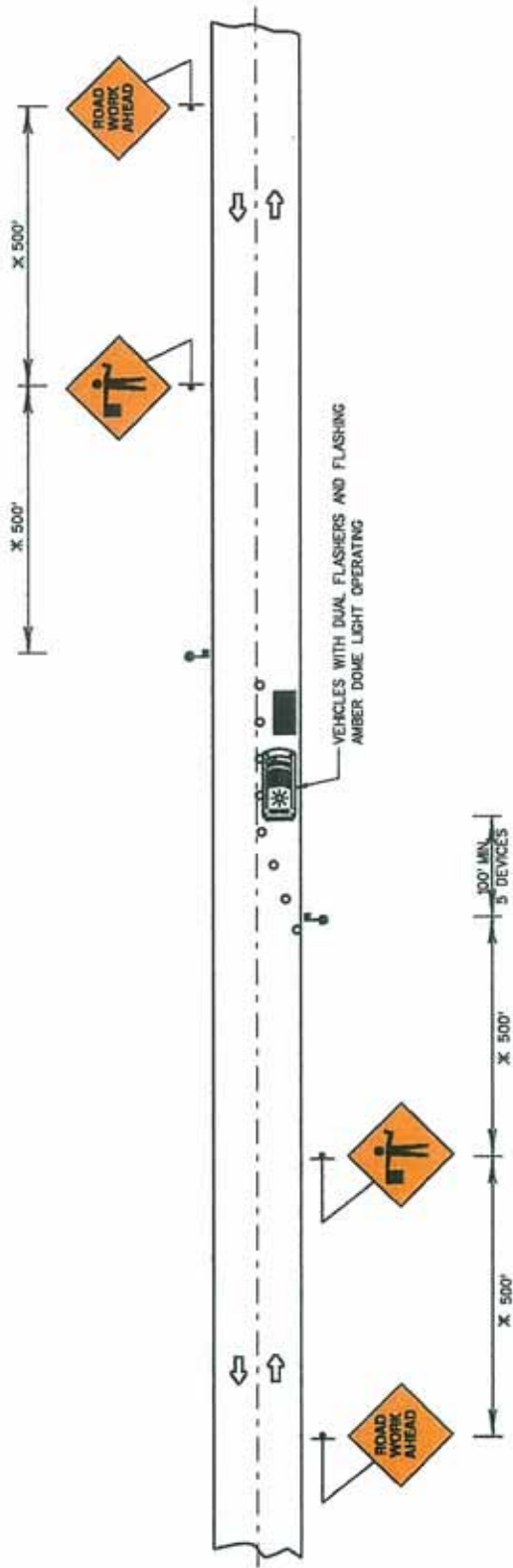

GENERAL NOTES

1. CONSTRUCTION OPERATIONS SHALL BE CONFINED TO ONE TRAFFIC LANE, LEAVING THE OPPOSITE LANE OPEN TO TRAFFIC.
2. IF THE WORK OPERATION DOES NOT EXCEED 60 MINUTES, TRAFFIC CONTROL WILL BE IN CONFORMANCE WITH CASE A6.
3. THE FLAGGERS SHALL BE IN SIGHT OF EACH OTHER OR IN DIRECT COMMUNICATION AT ALL TIMES.
4. IN LIGHT TRAFFIC WHEN THERE IS NO WORK BEING PERFORMED, FLAGGER SIGN(S) AND THE FLAGGER MAY NOT BE REQUIRED (AT THE OPTION OF THE ENGINEER. IN THIS CASE ONE LANE ROAD SIGN(S) SHALL BE INSTALLED IN PLACE OF THE FLAGGER SIGN(S).
5. WHEN A SIDE ROAD INTERSECTS THE HIGHWAY ON WHICH WORK IS BEING PERFORMED ADDITIONAL TRAFFIC CONTROL DEVICES SHALL BE ERECTED AS DIRECTED BY THE ENGINEER.
6. ALL VEHICLES, EQUIPMENT, WORKERS (EXCEPT FLAGGER) AND THEIR ACTIVITIES ARE RESTRICTED AT ALL TIMES TO ONE SIDE OF THE PAVEMENT UNLESS OTHERWISE AUTHORIZED BY THE ENGINEER.

SYMBOLS

- ▨ WORK AREA
- ◇ SIGN
- † SIGN ON PORTABLE OR PERMANENT SUPPORT.
- FLAGGER WITH PADDLE.
- CONES ON 25' CENTERS MAX.

TYPICAL APPLICATIONS

UTILITY OPERATIONS ONLY

CASE C2

TWO-LANE, TWO-WAY TRAFFIC
DAYLIGHT OPERATIONS ONLY

WHERE, AT ANY TIME, ANY VEHICLE, EQUIPMENT, WORKERS OR THEIR ACTIVITIES WILL ENCRoACH IN THE AREA BETWEEN THE CENTER LINE AND A LINE 2 FT. OUTSIDE THE EDGE OF PAVEMENT.

X - MAY BE DECREASED TO 200' TO 350' FOR URBAN AREAS

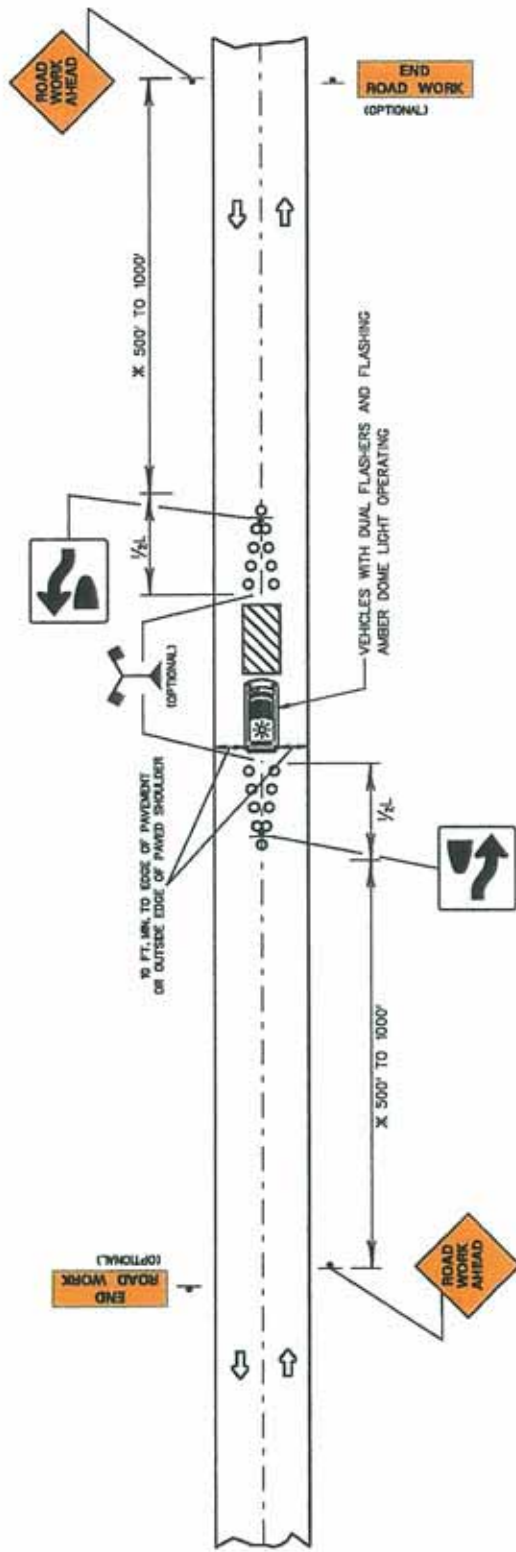

SPEED	L-TAPER (IN FEET)
25	125
30	180
35	250
40	320
45	440
50	600
55	660

GENERAL NOTES

1. THE LANES ON EITHER SIDE OF THE CENTER WORK SPACE SHOULD HAVE A MINIMUM WIDTH OF 30 FEET AS MEASURED FROM THE NEAR EDGE OF THE CHANNELIZING DEVICES TO THE EDGE OF PAVEMENT OR THE OUTSIDE EDGE OF PAVED SHOULDER.
2. WORKERS IN THE ROADWAY SHOULD WEAR HIGH-VISIBILITY CLOTHING AS DESCRIBED IN SECTION D.03.
3. WHEN NO WORK IS BEING PERFORMED, ANY UNATTENDED OBSTACLE OR EXCAVATION IN THE WORK AREA SHALL BE PROTECTED BY TYPE 1 OR TYPE B BARRICADES.
4. IF IT BECOMES NECESSARY TO OPERATE ONE LANE TRAFFIC, CASE A6 SHALL APPLY.
5. A LANE WIDTH OF 9 FT. MAY BE USED FOR SHORT-TERM STATIONARY WORK ON LOW-VOLUME, LOW-SPEED ROADWAYS WHEN MOTOR VEHICLE TRAFFIC DOES NOT INCLUDE LONGER AND WIDER HEAVY COMMERCIAL VEHICLES.
6. VEHICLE HAZARD WARNING SIGNALS MAY BE USED TO SUPPLEMENT HIGH-INTENSITY ROTATING, FLASHING, OSCILLATING, OR STROBE LIGHTS.

X - MAY BE DECREASED TO 200' TO 350' FOR URBAN AREAS.

SYMBOLS

- WORK AREA.
- SIGN
- SIGN ON PORTABLE OR PERMANENT SUPPORT.
- CONES ON 25' CENTERS MAX.

TYPICAL APPLICATIONS

UTILITY OPERATIONS ONLY

CASE C3

LOW VOLUME
TWO-LANE, TWO WAY OR MULTILANE,
TWO WAY TRAFFIC UNDIVIDED,
DAY OPERATIONS ONLY.

WHERE, AT ANY TIME, ANY VEHICLE, EQUIPMENT
WORKERS OR THEIR ACTIVITIES WILL ENDOURCH
IN THE CENTERLINE AREA.

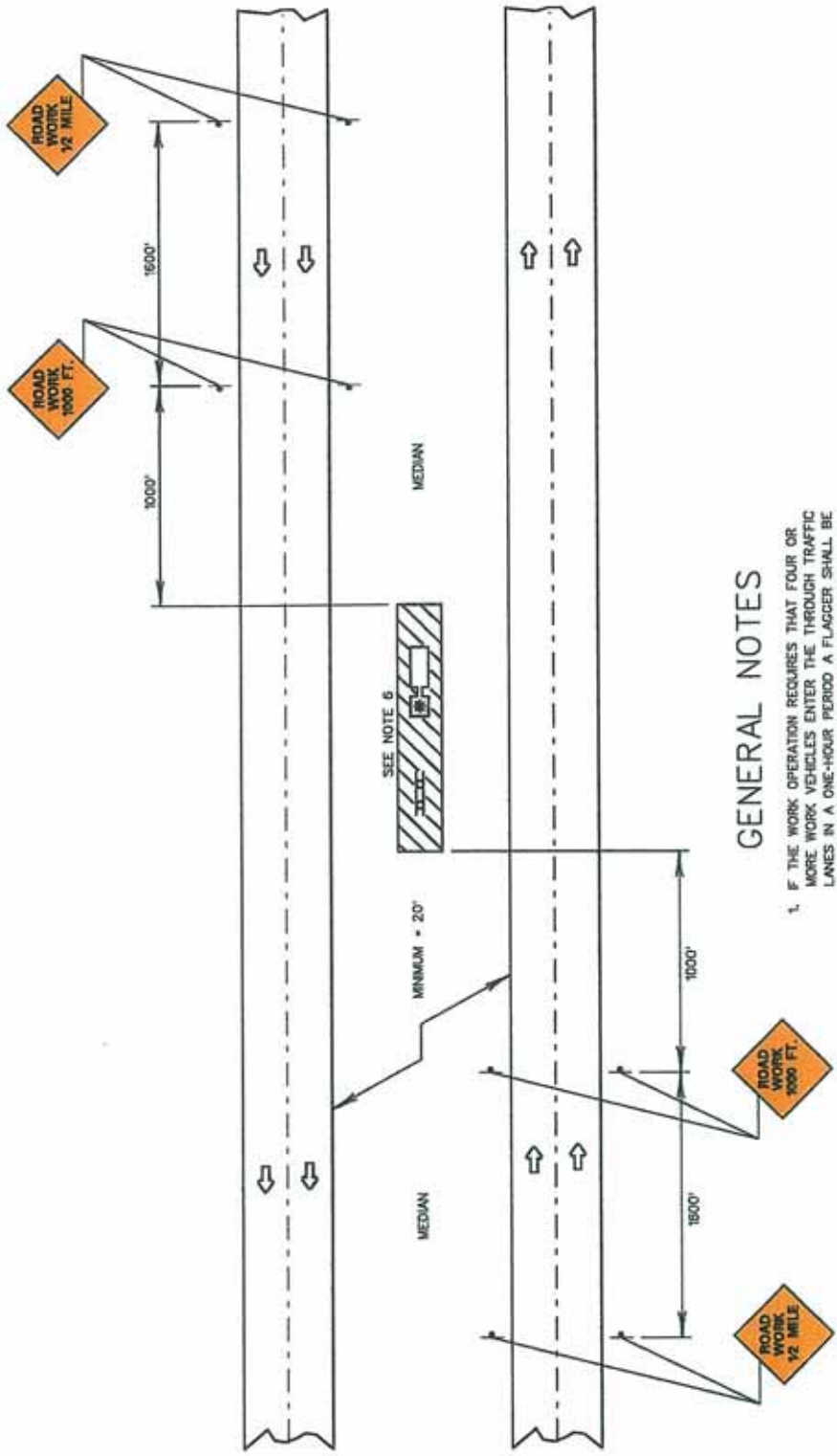

GENERAL NOTES

1. IF THE WORK OPERATION REQUIRES THAT FOUR OR MORE WORK VEHICLES ENTER THE THROUGH TRAFFIC LANES IN A ONE-HOUR PERIOD A FLAGGER SHALL BE PROVIDED AND ANOTHER FLAGGER SHALL ALSO BE USED AT 500' MIN. IN ADVANCE OF THE ABOVEMENTIONED FLAGGER.
2. THIS CASE APPLIES TO WORK PERFORMED IN THE MEDIAN AREA MORE THAN 2 FT. FROM THE EDGE OF EITHER SHOULDER.
3. IF THE WORK OPERATION DOES NOT EXCEED 60 MINUTES, TRAFFIC CONTROL WILL BE IN A CONFORMANCE WITH CASE A6.
4. UTILITY COMPANIES MAY WORK ON UTILITY CROSSINGS ON FULLY ACCESS CONTROLLED FREEWAYS UNDER EMERGENCY CONDITIONS AND BY PERMISSION OF THE WEST VIRGINIA DIVISION OF HIGHWAYS ONLY.
5. ALL VEHICLES, EQUIPMENT, WORKERS AND THEIR ACTIVITIES ARE RESTRICTED AT ALL TIMES TO ONE SIDE OF THE PAVEMENT (MEDIAN OR THE SIDE) UNLESS OTHERWISE AUTHORIZED BY THE ENGINEER.
6. TEMPORARY SUPPORT STRUCTURES SHALL BE PROTECTED BY EITHER TEMPORARY GUARDRAIL BARRIER IN CONFORMANCE WITH GUARDRAIL STANDARDS OR TEMPORARY CONCRETE BARRIER WITH STANDARD FLARE END TREATMENT AS APPROVED BY THE ENGINEER.

SYMBOLS

- WORK AREA.
- SIGN.
- SIGN ON PORTABLE OR PERMANENT SUPPORT.
- TEMPORARY SUPPORT STRUCTURE.
- FLASHING VEHICLE LIGHT.

TYPICAL APPLICATIONS

UTILITY OPERATIONS ONLY

CASE C4

MULTILANE, DIVIDED
WHERE AT ANY TIME ANY VEHICLE, EQUIPMENT,
WORKERS OR THEIR ACTIVITIES WILL ENCRoACH
IN THE MEDIAN AREA.

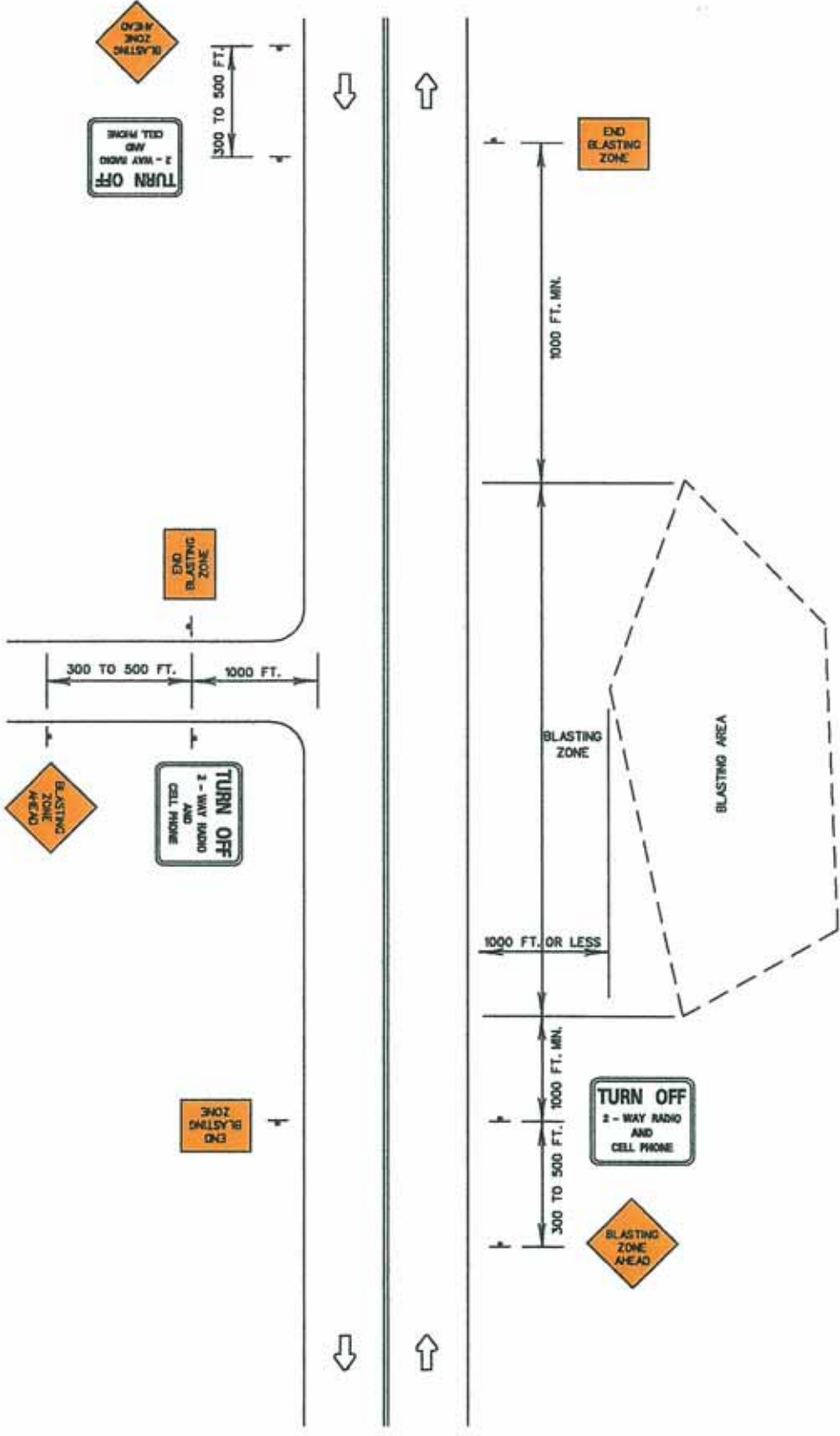

SYMBOLS

- SIGN
- ┆ SIGN ON PORTABLE OR PERMANENT SUPPORT

GENERAL NOTES

1. WHENEVER BLASTING CAPS ARE USED WITHIN 1000 FT. OF A ROADWAY, THE SIGNING SHOWN SHALL BE USED.
2. THE SIGNS SHALL BE COVERED OR REMOVED WHEN THERE ARE NO EXPLOSIVES IN THE AREA OR THE AREA IS OTHERWISE SECURE.
3. COORDINATE ALL BLASTING ZONE SIGNING WITH ANY OTHER SIGNING.
4. WHENEVER A SIDE ROAD INTERSECTS THE ROADWAY BETWEEN THE BLASTING ZONE AHEAD SIGN AND THE END BLASTING ZONE SIGN OR A SIDE ROAD IS WITHIN 1000 FT. OF ANY BLASTING CAP, SIMILAR SIGNING, AS ON THE MAINLINE, SHALL BE INSTALLED ON THE SIDE ROAD.
5. PRIOR TO BLASTING, THE BLASTER IN CHARGE SHALL DETERMINE WHETHER ROAD USERS IN THE BLASTING ZONE WILL BE ENDANGERED BY THE BLASTING OPERATION. IF THERE IS DANGER, ROAD USERS SHALL NOT BE PERMITTED TO PASS THROUGH THE BLASTING ZONE DURING BLASTING OPERATIONS.

CASE D1
 TWO-LANE, TWO-WAY
 BLASTING ZONE SIGNING

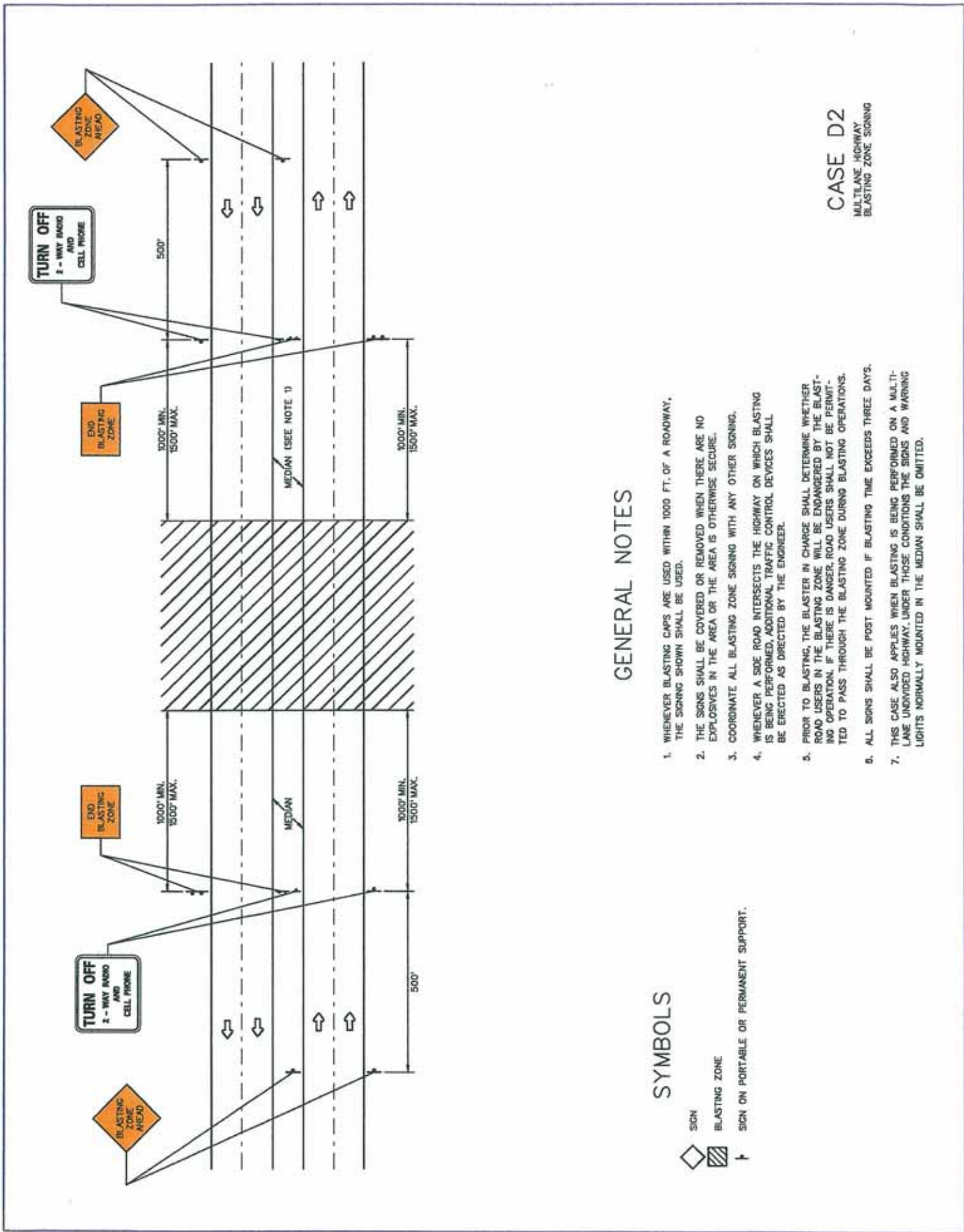

GENERAL NOTES

1. WHENEVER BLASTING CAPS ARE USED WITHIN 1000 FT. OF A ROADWAY, THE SIGNING SHOWN SHALL BE USED.
2. THE SIGNS SHALL BE COVERED OR REMOVED WHEN THERE ARE NO EXPLOSIVES IN THE AREA OR THE AREA IS OTHERWISE SECURE.
3. COORDINATE ALL BLASTING ZONE SIGNING WITH ANY OTHER SIGNING.
4. WHENEVER A SIDE ROAD INTERSECTS THE HIGHWAY ON WHICH BLASTING IS BEING PERFORMED, ADDITIONAL TRAFFIC CONTROL DEVICES SHALL BE ERRECTED AS DIRECTED BY THE ENGINEER.
5. PRIOR TO BLASTING, THE BLASTER IN CHARGE SHALL DETERMINE WHETHER ROAD USERS IN THE BLASTING ZONE WILL BE ENDANGERED BY THE BLASTING OPERATION. IF THERE IS DANGER, ROAD USERS SHALL NOT BE PERMITTED TO PASS THROUGH THE BLASTING ZONE DURING BLASTING OPERATIONS.
6. ALL SIGNS SHALL BE POST MOUNTED IF BLASTING TIME EXCEEDS THREE DAYS.
7. THIS CASE ALSO APPLIES WHEN BLASTING IS BEING PERFORMED ON A MULTI-LANE UNDIVIDED HIGHWAY, UNDER THOSE CONDITIONS THE SIGNS AND WARNING LIGHTS NORMALLY MOUNTED IN THE MEDIAN SHALL BE OMITTED.

SYMBOLS

- ◇ SIGN
- ▨ BLASTING ZONE
- ↑ SIGN ON PORTABLE OR PERMANENT SUPPORT.

CASE D2
MULTILANE HIGHWAY
BLASTING ZONE SIGNING

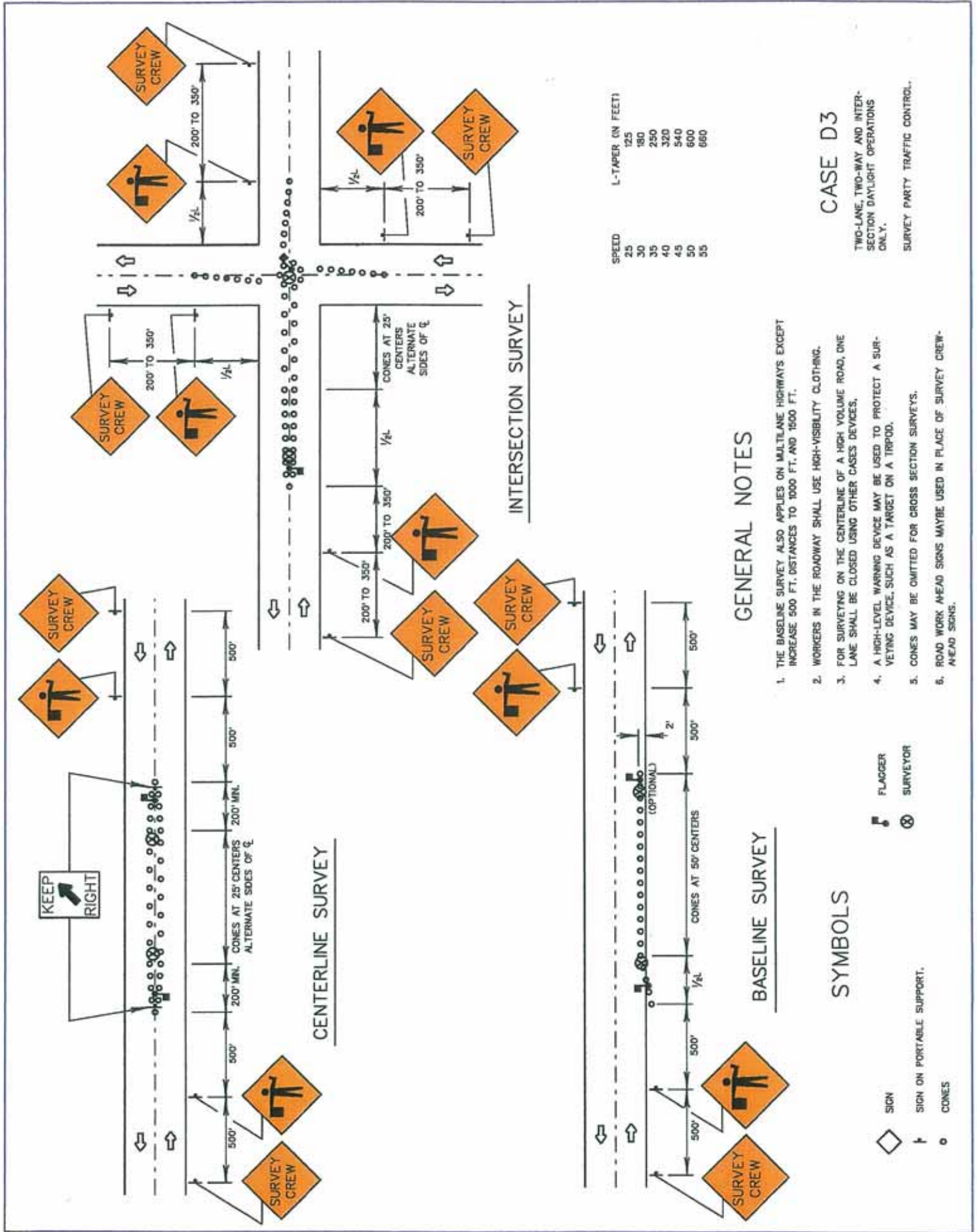

SPEED	L-TAPER (ON FEET)
25	125
30	180
35	250
40	320
45	540
50	600
55	660

GENERAL NOTES

1. THE BASELINE SURVEY ALSO APPLIES ON MULTILANE HIGHWAYS EXCEPT INCREASE 500 FT. DISTANCES TO 1000 FT. AND 1500 FT.
2. WORKERS IN THE ROADWAY SHALL USE HIGH-VISIBILITY CLOTHING.
3. FOR SURVEYING ON THE CENTERLINE OF A HIGH VOLUME ROAD, ONE LANE SHALL BE CLOSED USING OTHER CASES DEVICES.
4. A HIGH-LEVEL WARNING DEVICE MAY BE USED TO PROTECT A SURVEYING DEVICE, SUCH AS A TARGET ON A TRIPOD.
5. CONES MAY BE OMITTED FOR CROSS SECTION SURVEYS.
6. ROAD WORK AHEAD SIGNS MAYBE USED IN PLACE OF SURVEY CREW-AHEAD SIGNS.

CASE D3

TWO-LANE, TWO-WAY AND INTERSECTION DAYLIGHT OPERATIONS ONLY.
SURVEY PARTY TRAFFIC CONTROL.

BASELINE SURVEY

SYMBOLS

- SIGN
- SIGN ON PORTABLE SUPPORT.
- CONES
- FLAGGER
- SURVEYOR

CENTER LINE OR EDGE LINE OPERATIONS (TWO LANE OPERATIONS ONLY)

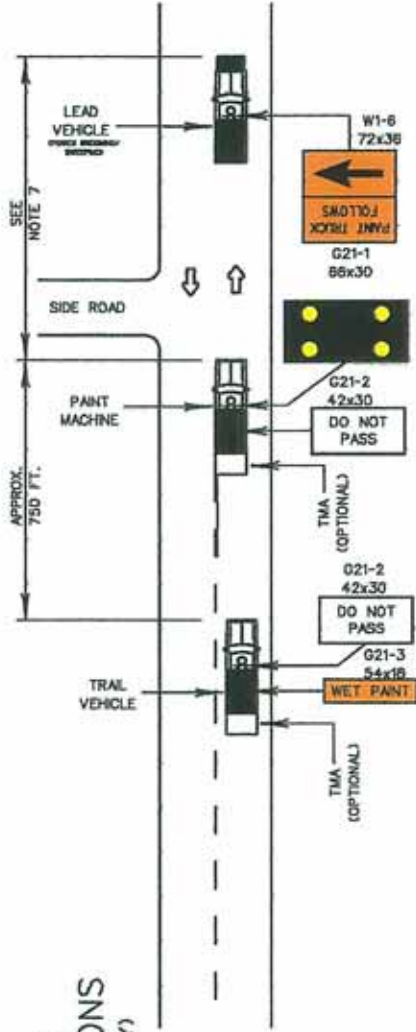

LANE LINE OR EDGE LINE OPERATIONS (MULTILANE OPERATIONS ONLY)

LANE LINE OPERATION MAY BE PERFORMED FROM EITHER THE LEFT OR RIGHT LANE (RIGHT LANE PREFERRED).

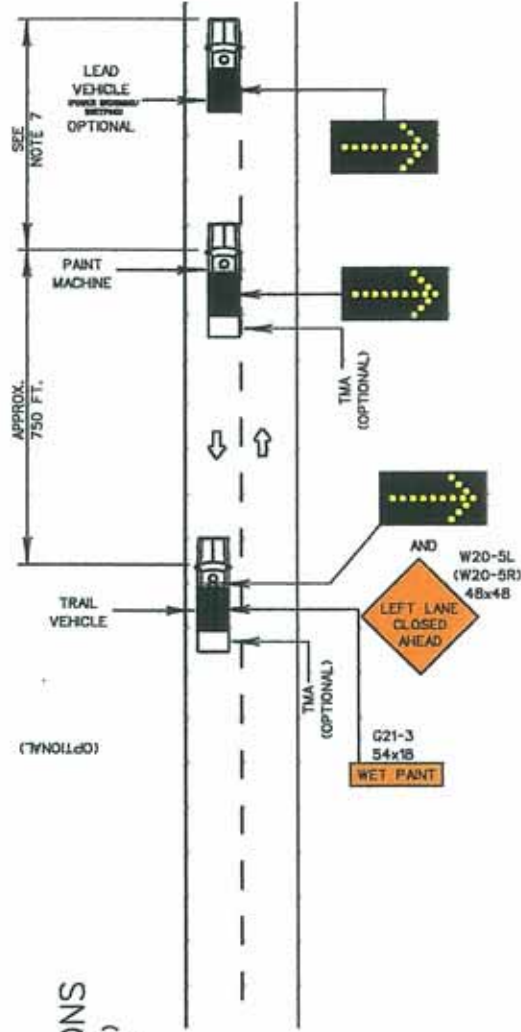

GENERAL NOTES

- FLASHING ARROW PANELS SHALL BE USED TO DIRECT TRAFFIC RIGHT OR LEFT AS INDICATED. MINIMUM SIZE SHALL BE 60"x30" FOR EDGE LINE OPERATIONS; NORMAL SIZE SHALL BE 96"x48" THE FLASHING ARROW PANEL SHALL BE MOUNTED A MINIMUM OF SEVEN (7) FEET ABOVE THE ROADWAY SURFACE.
- THE LEAD VEHICLE SHALL BE EQUIPPED WITH A 360° ROTATING YELLOW FLASHER ON THE CAB PLUS LIGHTED HEADLIGHTS AND TALLLIGHTS.
- THE PAINT VEHICLE SHALL BE EQUIPPED WITH SIGNS AS INDICATED, PLUS HIGH-INTENSITY ROTATING, FLASHING, OSCILLATING, OR STROBE LIGHTS ON THE CAB AND REAR PLUS LIGHTED HEADLIGHTS AND TALLLIGHTS.
- THE TRAIL VEHICLES SHALL BE EQUIPPED WITH A 360° ROTATING YELLOW FLASHER ON CAB PLUS LIGHTED HEADLIGHTS AND TALLLIGHTS.
- ALL CENTERLINE MARKING OPERATIONS SHALL BE CONDUCTED BY ALLEVIATING TRAFFIC CONGESTION EVERY 10 MINUTES OR AFTER A 20 VEHICLE BACKLOG WHICHEVER OCCURS FIRST.
- TWO-WAY RADIO COMMUNICATIONS SHALL BE MAINTAINED BETWEEN THE PAINT VEHICLE AND THE TRAIL VEHICLE.
- LEAD VEHICLE SHALL NORMALLY MAINTAIN VISUAL CONTACT WITH THE PAINT VEHICLE IN ORDER TO COORDINATE ON AND OFF ROAD MANEUVERS WHEN ALLEVIATING TRAFFIC BACKLOG.
- WHEN THE PAINT VEHICLE BECOMES STATIONARY, THE TRAIL VEHICLE SHALL MOVE TO A POSITION WITHIN 30 TO 50 FEET IN ADVANCE OF THE PAINT VEHICLE.

** THIS LIGHT SHALL BE MOUNTED ON TELESCOPING PIPE SO THAT IT MAY BE RAISED TO A HEIGHT OF 12 FEET ABOVE THE GROUND.

CASE D4
PAINT APPLICATION

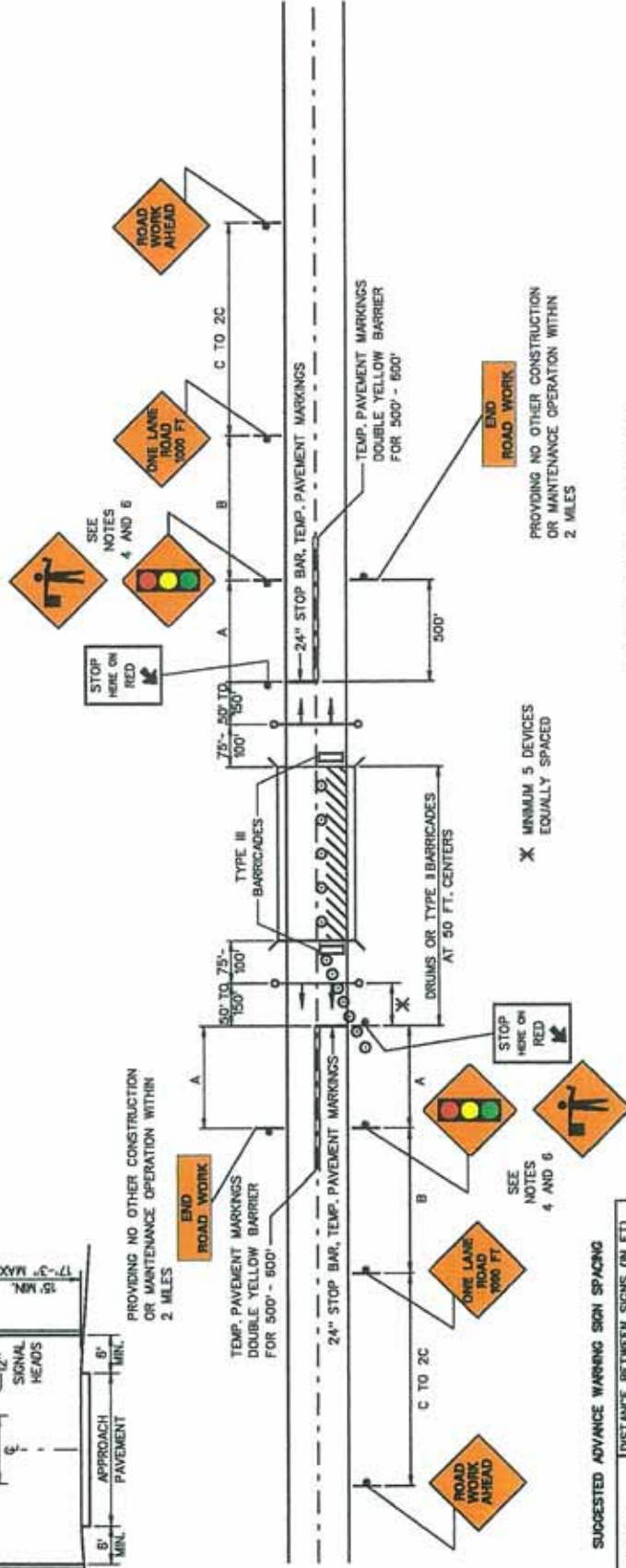

PROVIDING NO OTHER CONSTRUCTION OR MAINTENANCE OPERATION WITHIN 2 MILES

TEMP. PAVEMENT MARKINGS DOUBLE YELLOW BARRIER FOR 500' - 800'

TEMP. PAVEMENT MARKINGS DOUBLE YELLOW BARRIER FOR 500' - 600'

PROVIDING NO OTHER CONSTRUCTION OR MAINTENANCE OPERATION WITHIN 2 MILES

MINIMUM 5 DEVICES EQUALLY SPACED

SUGGESTED ADVANCE WARNING SIGN SPACING

ROAD TYPE	A	B	C
URBAN LOW SPEED*	100	100	100
URBAN HIGH SPEED**	250	350	350
RURAL	500	500	500
EXPRESSWAY/TREXWAY	1000	1500	2,000

*SPEED CATEGORY TO BE DETERMINED BY WY DOT

SYMBOLS

- SIGNAL HEADS (12")
- ▨ WORK AREA
- ◊ SIGN WITH TYPE 'B' LIGHT
- TYPE II BARRICADES.
- ⊥ SIGN ON PORTABLE OR PERMANENT SUPPORT.
- DRUM

TYPICAL APPLICATIONS

BRIDGE REPAIRS
SLIDES

GENERAL NOTES

1. THIS CASE ILLUSTRATES OVERHEAD INSTALLATION FOR PORTABLE INSTALLATION IF APPROVED, SEE CASE D5B.
2. THE CONTRACTOR SHALL BE RESPONSIBLE FOR THE MAINTENANCE OF THE TRAFFIC SIGNAL SYSTEM IN PLACE FOR THIS PROJECT. THIS RESPONSIBILITY SHALL BEGIN WITH THE INITIALIZATION OF THE WORK AND CONTINUE FOR THE LIFE OF THE CONTRACT. MAINTENANCE SHALL INCLUDE BUT NOT BE LIMITED TO REPAIR OF ACTS OF VANDALISM AS WELL AS NORMAL WEAR AND BURN OUT. ITEMS TO BE MAINTAINED AND/OR REPAIRED SHALL INCLUDE CONTROLLER, CABINETS, DETECTORS, SIGNAL HEADS, SUPPORT POSTS AND ANY OTHER EQUIPMENT OR MISCELLANEOUS ITEMS IN PLACE FOR THIS SIGNAL INSTALLATION.
3. SIGNAL TIMING INFORMATION WILL BE FURNISHED BY THE DIVISION OF HIGHWAYS AND MAY NOT BE CHANGED OR MODIFIED WITHOUT APPROVAL OF THE DIVISION OF HIGHWAYS.
4. IF DUE TO EQUIPMENT FAILURES OR OTHER REASONS THE SIGNAL MUST BE PUT ON FLASH OR SHUT DOWN, THE CONTRACTOR IS REQUIRED TO FURNISH OR COMPENSATE THE FLAGGERS OR LAW ENFORCEMENT OFFICERS REQUIRED TO CONTROL TRAFFIC. IF TRAFFIC CONTROL IS DONE BY CONTRACTOR PERSONNEL AND IS IN LINE WITH THEIR NORMAL WORKING DUTIES, NO COMPENSATION MAY BE REQUIRED. IN NO CASE SHALL THE SIGNAL SYSTEM BE DOWN FOR MORE THAN 24 HOURS UNLESS APPROVED BY THE ENGINEER OR OTHERWISE STATED IN THE PLANS.
5. IF THE SIGNAL IS NOT NEEDED FOR A PERIOD OF GREATER THAN 24 HOURS, DUE TO NORMAL OR NEAR NORMAL TRAFFIC CONDITIONS BEING RESTORED, THE CONTRACTOR MUST COVER THE SIGNAL HEADS.
6. IF FLAGGERS ARE USED INSTEAD OF SIGNALS THEY SHALL BE IN SIGHT OF EACH OTHER OR IN DIRECT COMMUNICATION AT ALL TIMES AND SIGNAL AHEAD SIGNS SHALL BE REPLACED WITH ADVANCE FLAGGER SIGNS.
7. ALL SIGNS SHALL BE POST MOUNTED IF THE CLOSURE TIME EXCEEDS THREE DAYS.
8. MINIMUM ADVANCE SIGHT DISTANCE ON ALL SIGNALS SHALL BE AS SPECIFIED IN SECTION 4D.15 OF THE MANUAL ON UNIFORM TRAFFIC CONTROL DEVICES, LATEST EDITION. EXACT LOCATION OF ALL SIGNAL HEADS SHALL BE AS DIRECTED BY THE ENGINEER.
9. FOR TEMPORARY TRAFFIC SIGNALS USED IN CONJUNCTION WITH OR AS PART OF EXISTING TRAFFIC SIGNALS - SEE CONTRACT PLANS.
10. FLASHING WARNING LIGHTS AND/OR FLAGS MAY BE USED TO CALL ATTENTION TO THE ABOVE WARNING SIGNS, AS NEEDED ON THE PLANS, AND/OR AS DIRECTED BY THE ENGINEER.

CASE D5A

TWO-LANE, TWO-WAY TRAFFIC
ONE LANE CLOSURE
OVERHEAD INSTALLATION
DAY OR NIGHT OPERATIONS

WHERE, AT ANY TIME, ANY VEHICLE, EQUIPMENT, WORKERS OR THEIR ACTIVITIES WILL ENCRUSH ON ONE LANE OF A BRIDGE DECK AND TRAFFIC SIGNALS ARE REQUIRED.

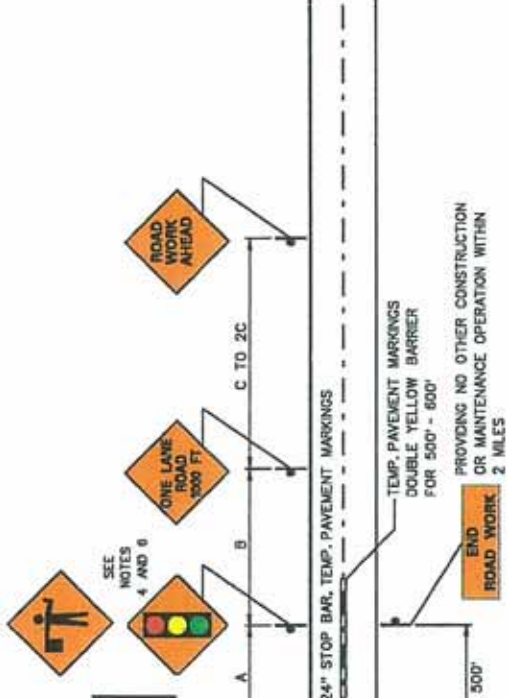
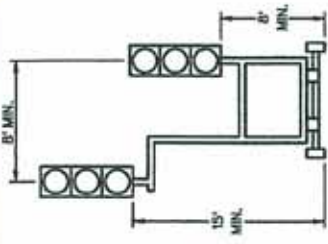

PROVIDING NO OTHER CONSTRUCTION OR MAINTENANCE OPERATION WITHIN 2 MILES

END ROAD WORK

TEMP. PAVEMENT MARKINGS DOUBLE YELLOW BARRIER FOR 500' - 800'

24" STOP BAR, TEMP. PAVEMENT MARKINGS

PROVIDING NO OTHER CONSTRUCTION OR MAINTENANCE OPERATION WITHIN 2 MILES

END ROAD WORK

MINIMUM 5 DEVICES EQUALLY SPACED

DRUMS OR TYPE II BARRICADES AT 50 FT. CENTERS

SUGGESTED ADVANCE WARNING SIGN SPACING

ROAD TYPE	DISTANCE BETWEEN SIGNS (IN FT.)		
	A	B	C
URBAN LOW SPEED*	100	100	100
URBAN HIGH SPEED*	350	350	350
RURAL	500	500	500
EXPRESSWAY/FREEWAY	1,000	1,500	2,000

*SPEED CATEGORY TO BE DETERMINED BY WV DMR

SYMBOLS

- SIGNAL HEADS (12")
- ▨ WORK AREA
- ◇ SIGN TYPE 'B' LIGHT
- ▮ TYPE II BARRICADES
- ⊥ SIGN ON PORTABLE OR PERMANENT SUPPORT
- DRUM

TYPICAL APPLICATIONS

BRIDGE REPAIRS
SLIDES

GENERAL NOTES

1. THIS CASE ILLUSTRATES PORTABLE INSTALLATION, FOR OVERHEAD INSTALLATION, SEE CASE D5A.
2. THE CONTRACTOR SHALL BE RESPONSIBLE FOR THE MAINTENANCE OF THE TRAFFIC SIGNAL SYSTEM IN PLACE FOR THIS PROJECT. THIS RESPONSIBILITY SHALL BEGIN WITH THE INITIALIZATION OF THE WORK AND CONTINUE FOR THE LIFE OF THE CONTRACT. MAINTENANCE SHALL INCLUDE BUT NOT BE LIMITED TO REPAIR OF ACTS OF VANDALISM AS WELL AS NORMAL WEAR AND BURN OUT. ITEMS TO BE MAINTAINED AND/OR REPAIRED SHALL INCLUDE CONTROLLER, CABINETS, DETECTORS, SIGNAL HEADS, SUPPORT POSTS AND ANY OTHER EQUIPMENT OR MISCELLANEOUS ITEMS IN PLACE FOR THIS SIGNAL INSTALLATION.
3. SIGNAL TIMING INFORMATION WILL BE FURNISHED BY THE DIVISION OF HIGHWAYS AND MAY NOT BE CHANGED OR MODIFIED WITHOUT APPROVAL OF THE DIVISION OF HIGHWAYS.
4. IF DUE TO EQUIPMENT FAILURES OR OTHER REASONS THE SIGNAL MUST BE PUT ON FLASH OR SHUT DOWN, THE CONTRACTOR IS REQUIRED TO FURNISH OR COMPENSATE THE FLAGGERS OR LAW ENFORCED OFFICERS REQUIRED TO CONTROL TRAFFIC. F TRAFFIC CONTROL IS DONE BY CONTRACTOR PERSONNEL AND IS IN LINE WITH THEIR NORMAL WORKING DUTIES, NO COMPENSATION MAY BE REQUIRED. IN NO CASE SHALL THE SIGNAL SYSTEM BE DOWN FOR MORE THAN 24 HOURS UNLESS APPROVED BY THE ENGINEER OR OTHERWISE STATED IN THE PLANS.
5. IF THE SIGNAL IS NOT NEEDED FOR A PERIOD OF GREATER THAN 24 HOURS, DUE TO NORMAL OR NEAR NORMAL TRAFFIC CONDITIONS BEING RESTORED, THE CONTRACTOR MUST COVER THE SIGNAL HEADS.
6. IF FLAGGERS ARE USED INSTEAD OF SIGNALS THEY SHALL BE IN SIGHT OF EACH OTHER OR IN DIRECT COMMUNICATION AT ALL TIMES AND SIGNAL AHEAD SIGNS SHALL BE REPLACED WITH ADVANCE FLAGGER SIGNS.

GENERAL NOTES - CONT.

7. ALL SIGNS SHALL BE POST MOUNTED IF THE CLOSURE TIME EXCEEDS THREE DAYS.
8. MINIMUM ADVANCE SIGHT DISTANCE ON ALL SIGNALS SHALL BE AS SPECIFIED IN SECTION 4D.15 OF THE MANUAL ON UNIFORM TRAFFIC CONTROL DEVICES, LATEST EDITION. EXACT LOCATION OF ALL SIGNALS HEADS SHALL BE AS DIRECTED BY THE ENGINEER.
9. FOR TEMPORARY TRAFFIC SIGNALS USED IN CONJUNCTION WITH OR AS PART OF EXISTING TRAFFIC SIGNALS - SEE CONTRACT PLANS.
10. FLASHING WARNING LIGHTS AND/OR FLAGS MAY BE USED TO CALL ATTENTION TO THE ABOVE WARNING SIGNS, AS NEEDED ON THE PLANS, AND/OR AS DIRECTED BY THE ENGINEER.

CASE D5B

TWO-LANE, TWO-WAY TRAFFIC
ONE LANE CLOSURE
PORTABLE INSTALLATION
DAY OR NIGHT OPERATIONS

WHERE, AT ANY TIME, ANY VEHICLE, EQUIPMENT, WORKERS OR THEIR ACTIVITIES WILL ENCRoACH ON ONE LANE OF A BRIDGE DECK AND TRAFFIC SIGNALS ARE REQUIRED.

- MINIMUM STANDARDS FOR PLACEMENT OF PORTABLE TRAFFIC SIGNALS
- ALL INSTALLATIONS OF PORTABLE TRAFFIC SIGNALS SHALL COMPLY WITH CASE D5B AND WITH THE FOLLOWING MINIMUM SPECIFICATIONS.
1. STANDARD CONTROLLER (NEMA) WITH TBC (TIME BASE COORDINATION) AND CONFLICT MONITOR.
 2. MUST BE HARDWARE FROM CONTROLLER TO SIGNAL HEADS (RADIO OR WIRELESS ARE NOT ACCEPTABLE).
 3. NO MANUAL CONTROL OVER LENGTH OF AMBER TIME.
 4. STANDARD 12" SIGNAL HEADS AND LAMPS.
 5. MINIMUM HORIZONTAL SIGNAL FACE SEPARATION OF 8 FEET.
 6. ONE SIGNAL HEAD MOUNTED A MINIMUM OF 15 FEET OVER APPROACH ROADWAY AND THE OTHER A MINIMUM OF 8 FEET ABOVE THE ROADWAY.
 7. POWER SUPPLY SHALL BE BY POWER COMPANY SERVICE OR GENERATOR.
 8. GENERATOR POWER SUPPLY SHALL HAVE A BATTERY BACKUP IF GENERATOR SHOULD FAIL.
- THE GENERAL GUIDELINES ARE THAT THE HIGH/LOW SIGNAL SHOULD BE PLACED ON THE SAME SIDE OF THE ROAD THAT THE DRIVER MUST STOP. THIS MAY REQUIRE THE TRAILER WITH SIGNALS TO BE PLACED BEHIND CURB/RAMP OR SOME METHOD TO PLACE THE TRAILER OFF THE ROADWAY, WHEN USED AS A THREE PHASE SIGNAL FOR AN ADDITIONAL SIGNALIZED APPROACH. A THIRD TRAILER OR TEMPORARY SUPPORT SHOULD BE USED TO PROVIDE HIGH/LOW INDICATIONS SEPARATED HORIZONTALLY BY 8 FEET.

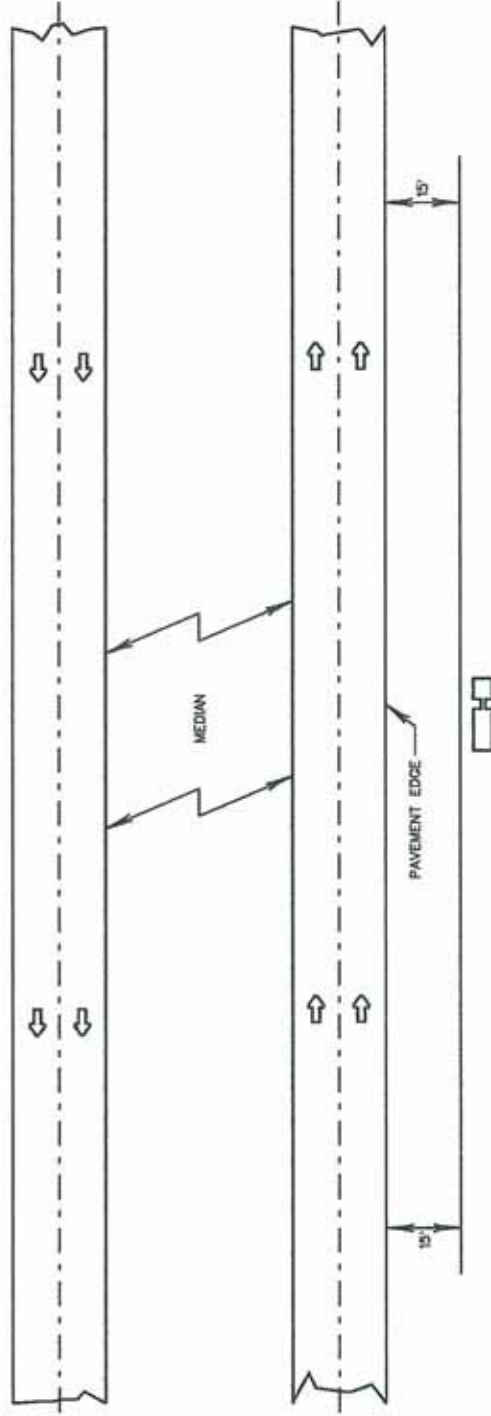

TYPICAL APPLICATIONS

LANDSCAPING WORK
FENCING CONTRACTS AND MAINTENANCE.
CLEANING CULVERTS.

GENERAL NOTES

1. NO SPECIAL SIGNING IS REQUIRED.
2. IF THE WORK OPERATION REQUIRES THAT TWO OR MORE WORK VEHICLES CROSS THE 15 FT. CLEAR ZONE IN ANY ONE HOUR, TRAFFIC CONTROL WILL BE IN CONFORMANCE WITH CASE E3.
3. THIS CASE ALSO APPLIES WHEN WORK IS BEING PERFORMED ON A MULTILANE UNDIVIDED HIGHWAY.

CASE E1

MULTILANE DIVIDED
DAY OR NIGHT OPERATIONS
WHERE, AT ALL TIMES, ALL VEHICLES,
EQUIPMENT, WORKERS OR THEIR ACTIVITIES
ARE AT ALL TIMES MORE THAN 15 FT.
FROM THE EDGE OF PAVEMENT.

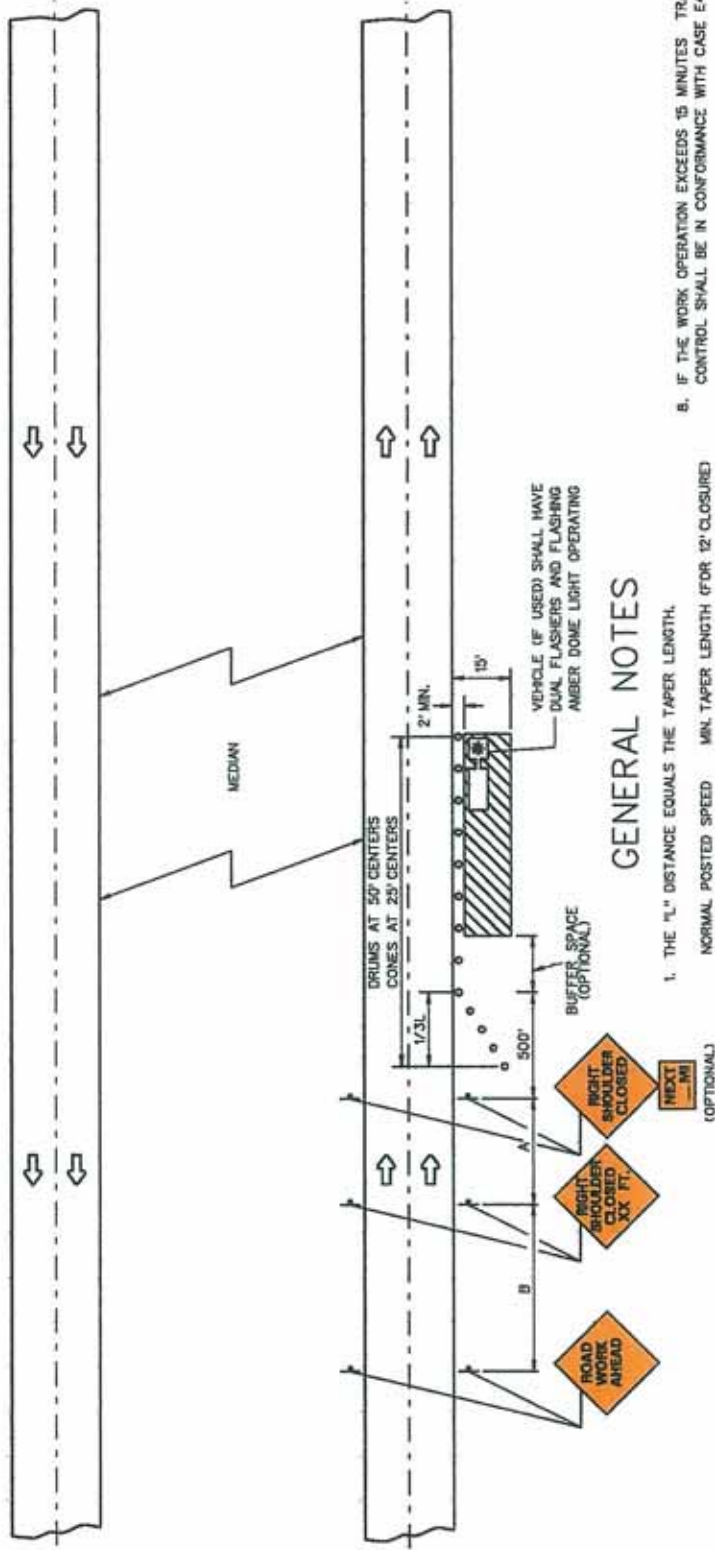

GENERAL NOTES

1. THE "L" DISTANCE EQUALS THE TAPER LENGTH.
2. OVERNIGHT OPERATIONS ILLUSTRATED AND F SUCH USE DRUMS. FOR DAYLIGHT OPERATIONS ONLY USE CONES OR DRUMS AS DIRECTED BY THE ENGINEER (MORE THAN 24 HOURS USE DRUMS).
3. IF THE WORK OPERATION REQUIRES THAT FOUR OR MORE WORK VEHICLES ENTER THE THROUGH TRAFFIC LANES IN A ONE-HOUR PERIOD A FLAGGER SHALL BE PROVIDED AND THE FLAGGER SIGN SHALL BE ERCTED ACCORDINGLY.
4. THIS CASE ALSO APPLIES TO WORK PERFORMED IN THE MEDIAN AREA MORE THAN 2 FT. BUT LESS THAN 15 FT. FROM THE EDGE OF EITHER PAVEMENT.
5. ANY UNATTACHED OBSTACLE OR EXCAVATION IN THE WORK AREA SHALL BE PROTECTED BY CHANNELIZATION DEVICES WITH FLASHING LIGHTS. (TYPE "A").
6. THIS CASE ALSO APPLIES WHEN WORK IS BEING PERFORMED ON A MULTILANE UNDIVIDED HIGHWAY. UNDER THESE CONDITIONS THE SIGNS NORMALLY MOUNTED IN THE MEDIAN SHALL BE OMITTED.
7. ALL VEHICLES, EQUIPMENT, WORKERS AND THEIR ACTIVITIES ARE RESTRICTED AT ALL TIMES TO ONE SIDE OF THE PAVEMENT UNLESS OTHERWISE AUTHORIZED BY THE ENGINEER.

NORMAL POSTED SPEED M.P.H.	MIN. TAPER LENGTH (FOR 12' CLOSURE) FEET
65	800
60	725
55	650
50	600
45	550
40 OR LESS	350

SYMBOLS

- WORK AREA.
- SIGN
- SIGN ON PORTABLE OR PERMANENT SUPPORT.
- CONES OR DRUMS

TYPICAL APPLICATIONS

- UTILITY OPERATIONS.
- CULVERT EXTENSIONS.
- SIDE SLOPE CHANGES.
- GUARDRAIL INSTALLATIONS AND MAINTENANCE.
- DELINEATOR INSTALLATIONS AND MAINTENANCE.
- LANDSCAPING OPERATIONS.
- CLEANING DITCHES AND DRAINAGE STRUCTURES.
- SIGN INSTALLATIONS AND MAINTENANCE.
- SHOULDER REPAIR.

SUGGESTED ADVANCE WARNING SIGN SPACING

ROAD TYPE	DISTANCE BETWEEN SIGNS (IN FT.)		
	A	B	C
URBAN (LOW SPEED)*	100	100	100
URBAN (HIGH SPEED)*	300	300	300
RURAL	500	500	500
EXPRESSWAY/FREEWAY	1,000	1,000	2,040

*SPEED CATEGORY TO BE DETERMINED BY WY DOH

CASE E2

MULTILANE, DIVIDED,
DAY OR NIGHT OPERATIONS,
AND MOBILE OPERATIONS
WHERE, AT ANY TIME, ANY VEHICLE,
EQUIPMENT, WORKERS OR THEIR AC-
TIVITIES WILL ENCRGACH IN THE AREA
BETWEEN 2 FT. AND 15 FT. FROM THE
EDGE OF PAVEMENT.

8. IF THE WORK OPERATION EXCEEDS 15 MINUTES TRAFFIC CONTROL SHALL BE IN CONFORMANCE WITH CASE E4.
9. FLASHING WARNING LIGHTS AND/OR FLAGS MAY BE USED TO CALL ATTENTION TO THE ABOVE WARNING SIGNS, AS NEEDED ON THE PLANS, AND/OR AS DIRECTED BY THE ENGINEER.

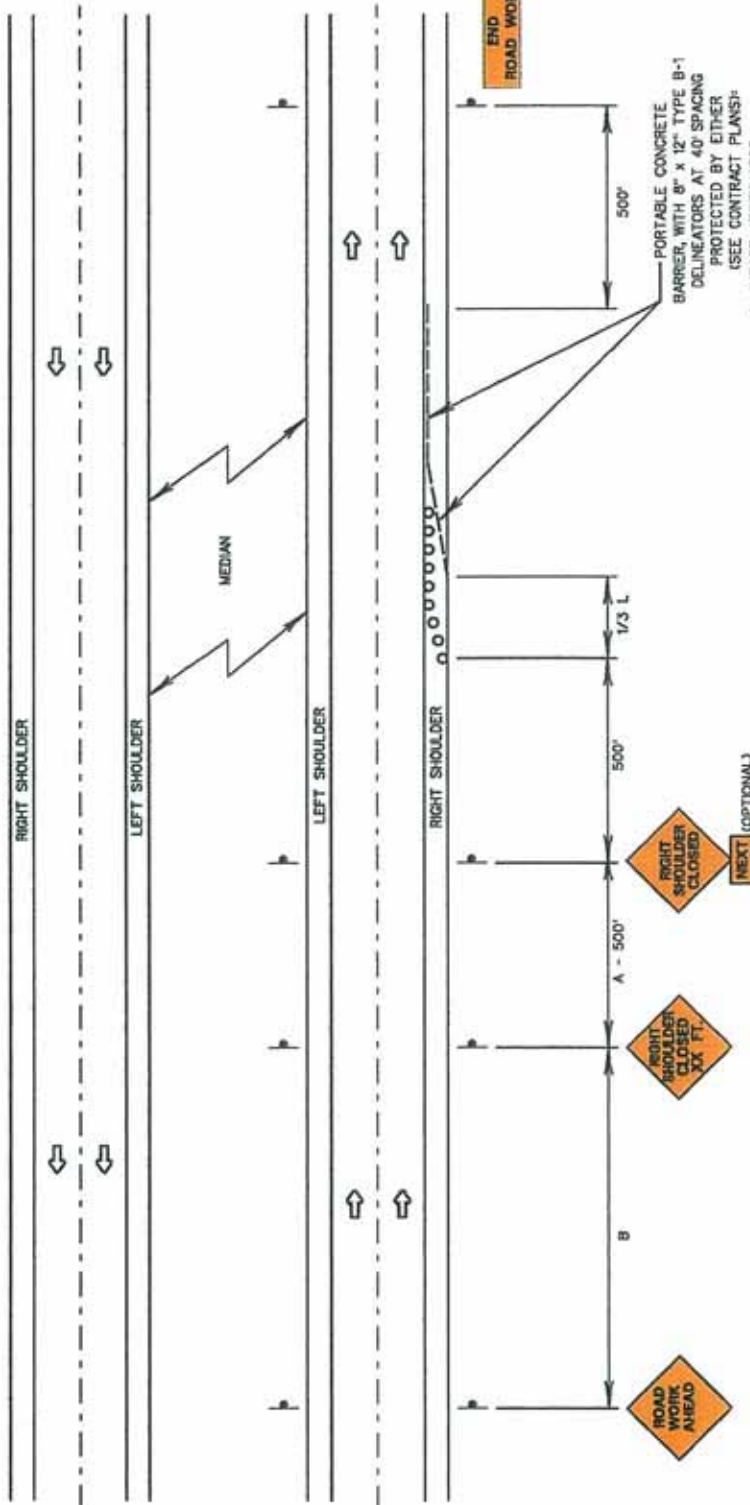

GENERAL NOTES

1. THE "L" DISTANCE EQUALS THE TAPER LENGTH.

NORMAL POSTED SPEED M.P.H.	MIN. TAPER LENGTH (FOR 12' CLOSURE) FEET
65	800
60	725
55	650
50	600
45	550
40 OR LESS	350

SYMBOLS

- ◇ SIGN
- † SIGN ON PORTABLE OR PERMANENT SUPPORT.
- CONES

TYPICAL APPLICATIONS

- LANDSCAPING WORK.
- FENCING WORK.
- CLEANING CULVERTS.
- SHOULDER WORK.

1. IMPACT ATTENUATOR
2. FLARED AWAY TO CLEAR ZONE AND PROPERLY ATTACHED TO APPROPRIATE GUARDRAIL, BOTH AT FLARE RATES AS NOTED IN CHAPTER 9 OF THE "ROADSIDE DESIGN GUIDE".
3. FLARED AWAY OR FLARED AWAY AND PROPERLY ATTACHED TO APPROPRIATE GUARDRAIL, BOTH AT FLARE RATES AS NOTED IN CHAPTER 9 OF THE "ROADSIDE DESIGN GUIDE".

SUGGESTED ADVANCE WARNING SIGN SPACING

ROAD TYPE	DISTANCE BETWEEN SIGNS (IN FT.)		
	A	B	C
URBAN LOW SPEED*	100	100	100
URBAN HIGH SPEED*	350	350	350
RURAL	500	500	500
EXPRESSWAY/FREEWAY	1,000	1,000	2,640

*SPEED CATEGORY TO BE DETERMINED BY WV DOH

CASE E3

- MULTILANE DIVIDED DAY OR NIGHT OPERATIONS
- SHOULDER CLOSED
- WHERE, AT ANY TIME, ANY VEHICLE, EQUIPMENT, WORKERS OR THEIR ACTIVITIES WILL ENCROACH IN THE AREA BETWEEN 2 FT. AND 15 FT. FROM THE EDGE OF PAVEMENT.

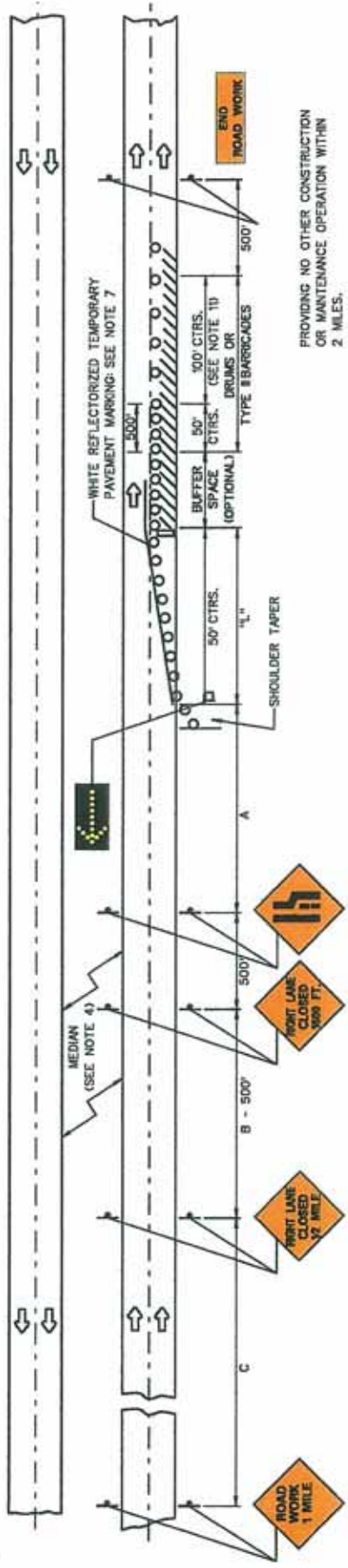

PROVIDING NO OTHER CONSTRUCTION OR MAINTENANCE OPERATION WITHIN 2 MILES.

GENERAL NOTES

1. THE "L" DISTANCE EQUALS THE TAPER LENGTH.
2. OVERNIGHT OPERATIONS ILLUSTRATED, FOR DAYLIGHT OPERATIONS, MAY USE CONES INSTEAD OF DRUMS.
3. WHEN CONSTRUCTION OPERATIONS CAUSE EQUIPMENT TO ENDOACH ON THE TRAVELED WAY, A FLAGGER WILL BE REQUIRED IN THE WORK ZONE WITH A FLAGGER SIGN PLACED 500' IN ADVANCE OF THE FLAGGER.
4. THE CASE ALSO APPLIES WHEN WORK IS BEING PERFORMED IN THE LANE ADJACENT TO THE MEDIAN ON A DIVIDED HIGHWAY. UNDER THESE CONDITIONS LEFT LANE CLOSED SIGNS SHALL BE SUBSTITUTED FOR RIGHT LANE CLOSED SIGNS.
5. THE CASE ALSO APPLIES WHEN WORK IS BEING PERFORMED IN THE LANE ADJACENT TO THE CENTER LINE ON AN UNDIVIDED HIGHWAY. UNDER THESE CONDITIONS LEFT LANE CLOSED SIGNS (S) SHALL BE SUBSTITUTED FOR RIGHT LANE CLOSED SIGNS (S). UNDER THESE CONDITIONS THE SIGNS NORMALLY MOUNTED IN THE MEDIAN SHALL BE OMITTED. SIGNS SHALL BE ADDED IN THE OPPOSITE DIRECTION IN CONFORMANCE WITH CASE A4 AND ADDITIONAL CHANNELIZATION DEVICES SHALL BE PLACED ALONG THE CENTER LINE THROUGH THE TAPER AND WORK AREA.
6. ALL SIGNS SHALL BE POST MOUNTED IF THE CLOSURE TIME EXCEEDS THREE DAYS.
7. REFLECTORIZED TEMPORARY PAVEMENT MARKING MAY BE OMITTED IF CLOSURE TIME IS LESS THAN SEVEN DAYS.
8. WHEN A SIDE ROAD INTERSECTS THE HIGHWAY ON WHICH WORK IS BEING PERFORMED OR MAINLINE OPPOSITE DIRECTION IS AFFECTED, ADDITIONAL TRAFFIC CONTROL DEVICES SHALL BE ERRECTED AS DIRECTED BY THE ENGINEER.
9. ALL VEHICLES, EQUIPMENT, WORKERS AND THEIR ACTIVITIES ARE RE-STRUCTED AT ALL TIMES TO ONE SIDE OF THE PAVEMENT UNLESS OTHERWISE AUTHORIZED BY THE ENGINEER.
10. CARE MUST BE TAKEN TO INSURE 24 HOUR OPERATION OF THE ELECTRIC ARROW. IT SHALL BE POSITIONED BEHIND THE CHANNELIZATION DEVICES AND SHALL NOT BE AN UNPROTECTED OBJECT TO THE MOTORIST. MINIMUM SIGHT DISTANCE IS 1,000 FT.
11. DEVICES SHALL BE SPACED AT 50' MIN. CENTERS WHEN WORK IS PERFORMED IN THIS AREA.
12. FLASHING WARNING LIGHTS AND/OR FLAGS MAY BE USED TO CALL ATTENTION TO THE ABOVE WARNING SIGNS, AS NEEDED ON THE PLANS, AND/OR AS DIRECTED BY THE ENGINEER.

SYMBOLS

- WORK AREA.
- SIGN
- TYPE B BARRICADE
- SIGN ON PORTABLE OR PERMANENT SUPPORT.
- DRUMS
- ELECTRIC ARROW.

TYPICAL APPLICATIONS

- PAVEMENT REPAIRS
- PAVING
- SLIDES
- BRIDGE DECK REPAIRS

SUGGESTED ADVANCE WARNING SIGN SPACING

ROAD TYPE	DISTANCE BETWEEN SIGNS (IN FT)		
	A	B	C
URBAN LOW SPEED*	100	100	100
URBAN HIGH SPEED**	350	350	350
RURAL	500	500	500
EXPRESSWAY/FREEWAY	1,000	1,500	2,440

*SPEED CATEGORY TO BE DETERMINED BY WV DOH

CASE E4

MULTILANE, DIVIDED DAY OR NIGHT OPERATIONS
SINGLE LANE CLOSURE - STATIONARY
WHERE AT ANY TIME ANY VEHICLE, EQUIPMENT, WORKERS OR THEIR ACTIVITIES WILL ENDOACH ON ANY PORTION OF THE LANE IMMEDIATELY ADJACENT TO THE SHOULDER OR ON THE SHOULDER WITHIN 2 FEET OF THE EDGE OF PAVEMENT.

PROVIDING NO OTHER CONSTRUCTION OR MAINTENANCE OPERATION WITHIN 2 MILES.

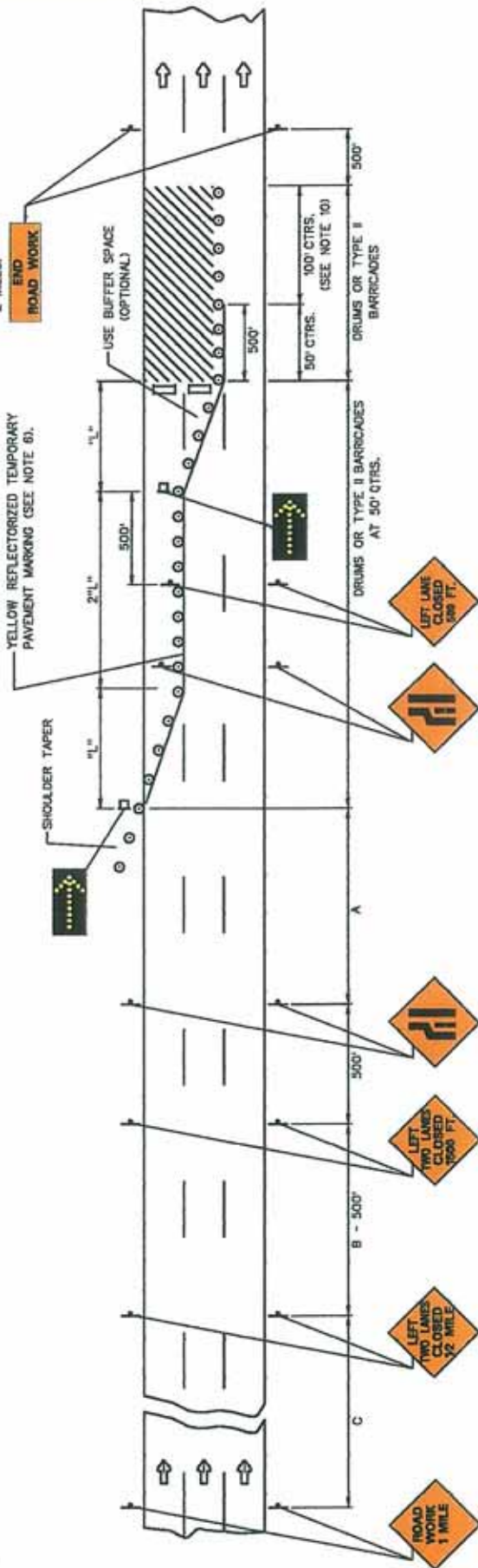

GENERAL NOTES

1. THE "L" DISTANCE EQUALS THE TAPER LENGTH.
2. OVERNIGHT OPERATIONS ILLUSTRATED, AND IF SUCH, USE DRUMS. FOR DAYLIGHT OPERATIONS MAY SUBSTITUTE CONES FOR DRUMS.
3. WHEN CONSTRUCTION OPERATIONS CAUSE EQUIPMENT TO ENCRoACH ON THE TRAVELED WAY, A FLAGGER WILL BE REQUIRED IN THE WORK ZONE WITH A FLAGGER SIGN PLACED 500' IN ADVANCE OF THE FLAGGER.
4. THIS CASE ALSO APPLIES WHEN WORK IS BEING PERFORMED IN THE TWO LANES ADJACENT TO THE SHOULDER ON A DIVIDED HIGHWAY. UNDER THESE CONDITIONS ALL SIGNS SHALL BE CHANGED TO REFLECT THE CLOSURE OF THE RIGHT LANES.
5. ALL SIGNS EXCEPT THOSE IN ROADWAY SHALL BE POST MOUNTED IF CLOSURE TIME EXCEEDS THREE DAYS.
6. REFLECTORIZED TEMPORARY PAVEMENT MARKING MAY BE OMITTED IF CLOSURE TIME IS LESS THAN SEVEN DAYS.
7. WHEN A SIDE ROAD INTERSECTS THE HIGHWAY ON WHICH WORK IS BEING PERFORMED OR MAINLINE OPPOSITE DIRECTION IS AFFECTED, ADDITIONAL TRAFFIC CONTROL DEVICES SHALL BE ERECTED AS DIRECTED BY THE ENGINEER.
8. ALL VEHICLES, EQUIPMENT, WORKERS AND THEIR ACTIVITIES ARE RESTRICTED AT ALL TIMES TO THE WORK AREA SIDE OF THE TRAFFIC CONTROL DEVICES UNLESS OTHERWISE AUTHORIZED BY THE ENGINEER.
9. CARE MUST BE TAKEN TO INSURE 24 HOUR OPERATION OF THE ELECTRIC ARROW. THEY SHALL BE POSITIONED BEHIND THE CHANNELIZATION DEVICES AND SHALL NOT BE AN UNPROTECTED OBJECT TO THE MOTORIST. MINIMUM SIGHT DISTANCE IS 1,000 FT.
10. DEVICES SPACED AT 50' CENTERS SHALL BE USED TO SUPPLEMENT DEVICES SPACED AT 100' CENTERS WHEN WORK IS PERFORMED IN THIS AREA.
11. FLASHING WARNING LIGHTS AND/OR FLAGS MAY BE USED TO CALL ATTENTION TO THE ABOVE WARNING SIGNS, AS NEEDED ON THE PLANS, AND/OR AS DIRECTED BY THE ENGINEER.

NORMAL POSTED SPEED M.P.H.	MINIMUM TAPER LENGTH (FOR 12' CLOSURE) FEET
85	800
60	725
35	650
30	600
45	550
40 OR LESS	350

SYMBOLS

- WORK AREA.
- SIGN
- TYPE II BARRICADE
- SIGN ON PORTABLE OR PERMANENT SUPPORT.
- CHANNELIZATION DEVICE.
- ELECTRIC ARROW

TYPICAL APPLICATIONS

- PAVEMENT REPAIR
- PAVING
- SLURIES
- BRIDGE DECK REPAIRS

CASE E5

- MULTILANE DIVIDED
- DAY OR NIGHT OPERATIONS
- DOUBLE LANE CLOSURE
- WHERE AT ANY TIME ANY VEHICLE, EQUIPMENT, WORKERS OR THEIR ACTIVITIES WILL ENCRoACH ON ANY PORTION OF THE TWO LANES IMMEDIATELY ADJACENT TO THE SHOULDER OR MEDIAN.

SUGGESTED ADVANCE WARNING SIGN SPACING

ROAD TYPE	DISTANCE BETWEEN SIGNS (IN FT)		
	A	B	C
URBAN (LOW SPEED)**	500	100	100
URBAN (HIGH SPEED)**	350	350	350
RURAL	500	500	500
EXPRESSWAY/FREEWAY	1,000	1,500	2,840

*SPEED CATEGORY TO BE DETERMINED BY WY DOT

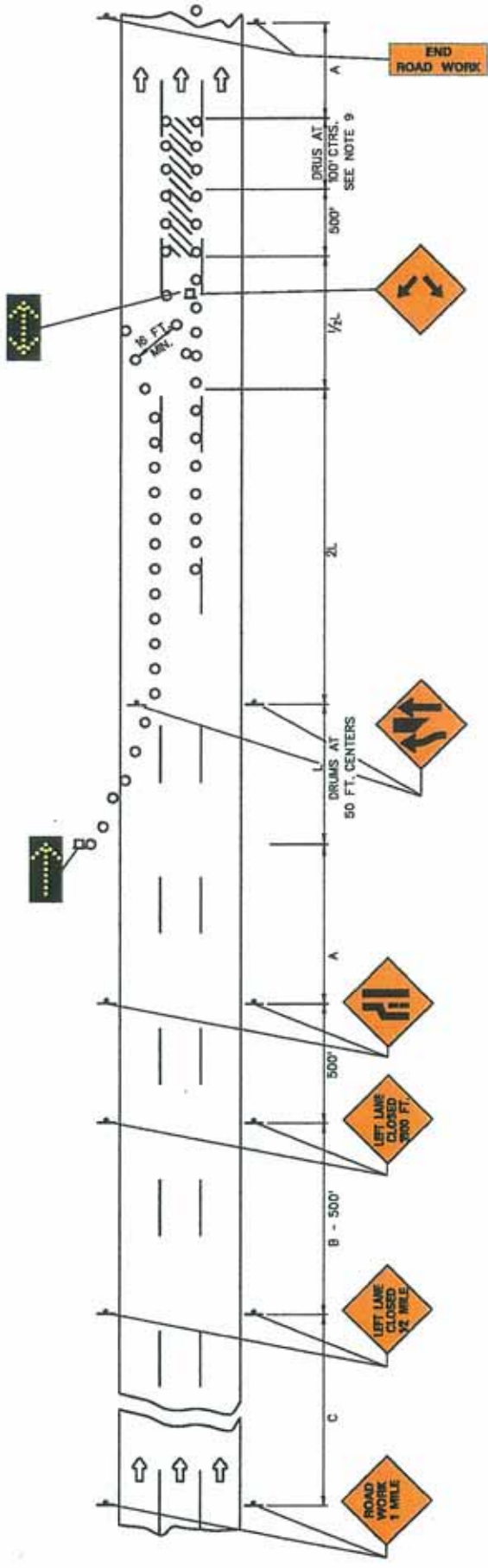

GENERAL NOTES

- CARE MUST BE TAKEN TO INSURE 24-HOUR OPERATION OF THE ELECTRIC ARROW. THEY SHALL BE POSITIONED BEHIND THE CHANNELIZING DEVICES AND SHALL NOT BE AN UNPROTECTED OBJECT TO THE MOTORIST. MINIMUM SIGHT DISTANCE IS 1,000 FT.
- DEVICES SPACED AT 50' CENTERS SHALL BE USED TO SUPPLEMENT DEVICES SPACED AT 100' CENTERS WHEN WORK IS BEING PERFORMED IN THIS AREA.
- FOR A LONG-TERM CLOSURE, A BARRIER SHOULD BE USED TO PROVIDE ADDITIONAL SAFETY TO THE OPERATION IN THE CLOSED INTERIOR LANE. A BUFFER SPACE SHOULD BE USED AT THE UPSTREAM END OF THE CLOSED INTERIOR LANE.
- THE FIRST ARROW PANEL DISPLAYING A RIGHT ARROW SHOULD BE ON THE LEFT SHOULDER AT THE BEGINNING OF THE TAPER. THE ARROW PANEL DISPLAYING A DOUBLE ARROW SHOULD BE CENTERED IN THE CLOSED INTERIOR LANE AND PLACED AT THE DOWNSTREAM END OF THE SHIFTING TAPER.
- THE PLACEMENT OF SIGNS SHOULD NOT OBSTRUCT OR OBSCURE ELECTRIC ARROW.
- FOR LONG-TERM USE, THE DASHED LANE LINES SHOULD BE MADE SOLID WHITE IN THE TWO-LANE SECTION.
- A SHORT, SINGLE ROW OF CHANNELIZING DEVICES IN ADVANCE OF THE MOTOR VEHICLE TRAFFIC SPLIT TO RESTRICT VEHICULAR TRAFFIC TO THEIR RESPECTIVE LANES MAY BE ADDED.
- DO NOT PASS SIGNS MAY BE USED.
- FLASHING WARNING LIGHTS AND/OR FLAGS MAY BE USED TO CALL ATTENTION TO THE ABOVE WARNING SIGNS, AS NEEDED ON THE PLANS, AND/OR AS DIRECTED BY THE ENGINEER.

CASE E6

MULTILANE DIVIDED DAY OR NIGHT OPERATIONS INTERIOR LANE CLOSURE ON FREEWAY WHERE AT ANY TIME ANY VEHICLE, EQUIPMENT, WORKERS OR THEIR ACTIVITIES WILL ENCRUCH ON ANY PORTION OF THE CENTER LANE OF A MULTILANE ROADWAY.

SUGGESTED ADVANCE WARNING SIGN SPACING

ROAD TYPE	DISTANCE BETWEEN SIGNS (IN FT.)		
	A	B	C
URBAN LOW SPEED*	100	100	100
URBAN HIGH SPEED*	350	350	350
RURAL	500	500	500
EXPRESSWAY/FREEWAY	1,000	1,000	2,640

*SPEED CATEGORY TO BE DETERMINED BY WV DOH

SYMBOLS

- WORK AREA
- SIGN
- TYPE III BARRICADE
- SIGN ON PORTABLE OR PERMANENT SUPPORT.
- DRUM
- ELECTRIC ARROW

TYPICAL APPLICATIONS

- PAVEMENT REPAIR
- PAVING
- BRIDGE DECK REPAIRS

1. THE "L" DISTANCE EQUALS THE TAPER LENGTH.

NORMAL POSTED SPEED M.P.H.	MINIMUM TAPER LENGTH (FOR 12' CLOSED FEET)
65	800
60	725
55	650
50	600
45	550
40 OR LESS	350

2. WHEN CONSTRUCTION OPERATIONS CAUSE EQUIPMENT TO ENCRUCH ON THE TRAVELED WAY, A FLAGGER WILL BE REQUIRED IN THE WORK ZONE WITH A FLAGGER SIGN PLACED 500' IN ADVANCE OF THE FLAGGER.

3. THIS CASE ALSO APPLIES WHEN WORK IS BEING PERFORMED IN THE TWO LANES ADJACENT TO THE SHOULDER ON A DIVIDED HIGHWAY. UNDER THESE CONDITIONS ALL SIGNS SHALL BE CHANGED TO REFLECT THE CLOSURE OF THE RIGHT LANES.

4. ALL SIGNS EXCEPT THOSE IN ROADWAY SHALL BE POST MOUNTED IF CLOSURE TIME EXCEEDS THREE DAYS.

5. REFLECTORIZED TEMPORARY PAVEMENT MARKING MAY BE OMITTED IF CLOSURE TIME IS LESS THAN SEVEN DAYS.

6. WHEN A SIDE ROAD INTERSECTS THE HIGHWAY ON WHICH WORK IS BEING PERFORMED OR MANLINE OPPOSITE DIRECTION IS AFFECTED, ADDITIONAL TRAFFIC CONTROL DEVICES SHALL BE ERCTED AS DIRECTED BY THE ENGINEER.

7. ALL VEHICLES, EQUIPMENT, WORKERS AND THEIR ACTIVITIES ARE RESTRICTED AT ALL TIMES TO THE WORK AREA SIDE OF THE TRAFFIC CONTROL DEVICES UNLESS OTHERWISE AUTHORIZED BY THE ENGINEER.

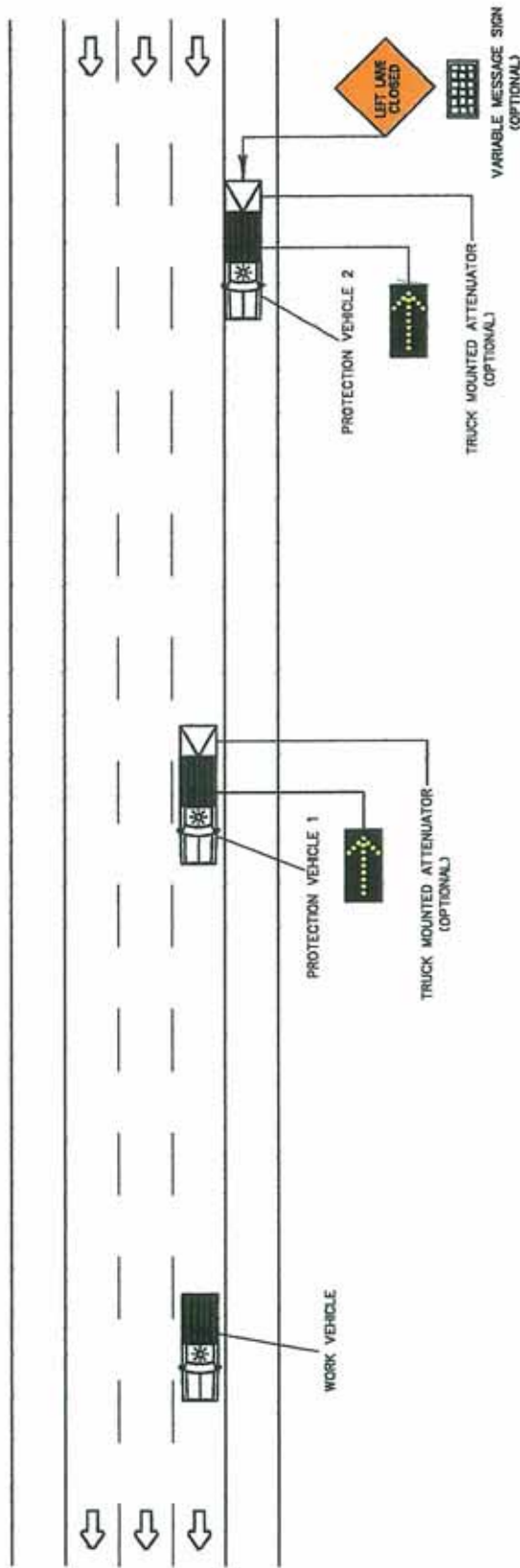

GENERAL NOTES

1. ARROW PANELS SHALL BE AS A MINIMUM TYPE B, 60"x30".
2. VEHICLES USED FOR THESE OPERATIONS SHOULD BE MADE HIGHLY VISIBLE WITH APPROPRIATE EQUIPMENT, SUCH AS: FLAGS, SIGNS, ARROW PANELS, AND HIGH-INTENSITY ROTATING FLASHING, OSCILLATING, OR STROBE LIGHTS.
3. PROTECTION VEHICLE #1 SHOULD BE EQUIPPED WITH AN ARROW PANEL AND TRUCK-MOUNTED ATTENUATOR.
4. PROTECTION VEHICLE #2 SHOULD BE EQUIPPED WITH AN ARROW PANEL IN A CAUTION MODE IF ON THE SHOULDER, AN APPROPRIATE LANE CLOSURE SIGN SHOULD BE PLACED ON PROTECTION VEHICLE #2 SO AS NOT TO OBSCURE THE ARROW PANEL.
5. PROTECTION VEHICLE #2 SHOULD TRAVEL AT A VARYING DISTANCE FROM THE WORK OPERATION SO AS TO PROVIDE ADEQUATE SIGHT DISTANCE FOR VEHICULAR TRAFFIC APPROACHING FROM THE REAR.
6. THE SPACING BETWEEN THE WORK VEHICLES AND PROTECTION VEHICLES, AND BETWEEN EACH PROTECTION VEHICLE SHOULD BE MINIMIZED TO DETER ROAD USERS FROM DRIVING IN BETWEEN WHERE ADEQUATE SHOULDER WIDTH IS NOT AVAILABLE, PROTECTION VEHICLE #3 MAY DRIVE PARTIALLY IN THE LANE.
7. WORK SHOULD NORMALLY BE ACCOMPLISHED DURING OFF-PEAK HOURS.
8. ON HIGH-SPEED ROADWAYS, A THIRD PROTECTION VEHICLE (NOT SHOWN) MAY BE USED -- PROTECTION VEHICLE #1 IN THE CLOSED LANE, PROTECTION VEHICLE #2 STRADDLING THE EDGE LINE, AND PROTECTION VEHICLE #3 ON THE SHOULDER.

SYMBOLS

- ┆ SIGN ON PORTABLE OR PERMANENT SUPPORT
- * FLASHING VEHICLE LIGHT
- ➡ ELECTRIC ARROW

TYPICAL APPLICATIONS

DEBRIS REMOVAL

CASE E7

MULTILANE
DAY OPERATIONS
MOBILE OPERATIONS

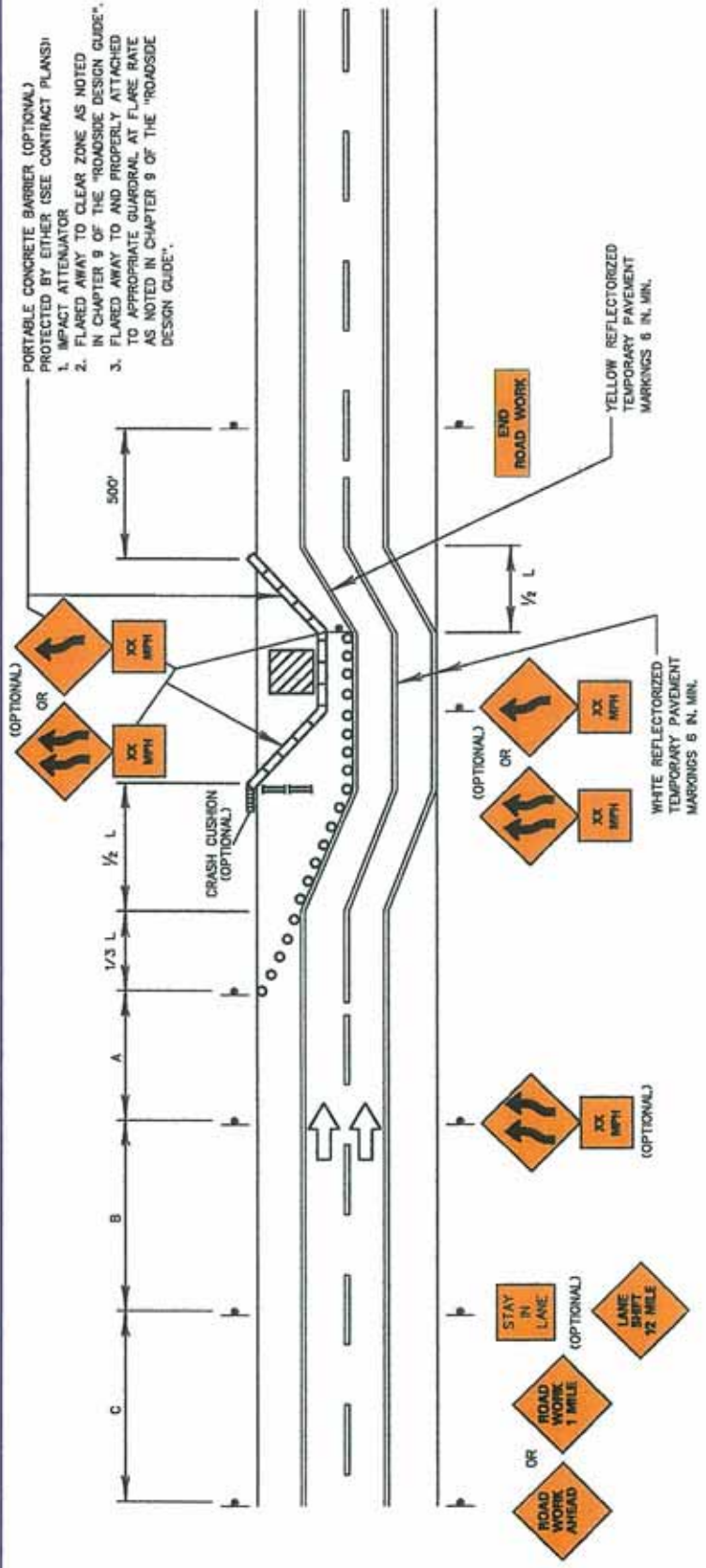

PORTABLE CONCRETE BARRIER (OPTIONAL)
PROTECTED BY EITHER (SEE CONTRACT PLANS)
1. IMPACT ATTENUATOR
2. FLARED AWAY TO CLEAR ZONE AS NOTED
IN CHAPTER 9 OF THE "ROADSIDE DESIGN GUIDE".
3. FLARED AWAY TO AND PROPERLY ATTACHED
TO APPROPRIATE GUARDRAIL AT FLARE RATE
AS NOTED IN CHAPTER 9 OF THE "ROADSIDE
DESIGN GUIDE".

SUGGESTED ADVANCE WARNING SIGN SPACING

ROAD TYPE	DISTANCE BETWEEN SIGNS (IN FT)		
	A	B	C
URBAN LOW SPEED*	100	100	100
URBAN HIGH SPEED*	350	350	350
RURAL	500	500	500
EXPRESSWAY/FREEWAY	1,000	1,000	2,040

*SPEED CATEGORY TO BE DETERMINED BY WV DCH

SYMBOLS

- WORK AREA.
- SIGN
- TYPE II BARRICADE
- SIGN ON PORTABLE OR PERMANENT SUPPORT.
- DRUM.
- POSITIVE SEPARATION (E.G. TEMPORARY CONCRETE BARRIER, SEE CONTRACT PLANS).

GENERAL NOTES

1. THE "L" DISTANCE EQUALS THE TAPER LENGTH.
NORMAL POSTED SPEED M.P.H. TAPER LENGTH (FOR 12' CLOSURE) FEET
65 800
60 725
55 650
50 600
45 550
40 OR LESS 350
2. THIS CASE ALSO APPLIES WHEN WORK IS BEING PERFORMED ON A MULTILANE UNDIVIDED HIGHWAY. UNDER THESE CONDITIONS THE SIGNS NORMALLY MOUNTED IN THE MEDIAN SHALL BE OMITTED.
3. ALL VEHICLES, EQUIPMENT, WORKERS AND THEIR ACTIVITIES ARE RESTRICTED AT ALL TIMES TO ONE SIDE OF THE PAVEMENT UNLESS OTHERWISE AUTHORIZED BY THE ENGINEER.
4. WHEN A SIDE ROAD INTERSECTS THE HIGHWAY ON WHICH WORK IS BEING PERFORMED OR MANLINE OPPOSITE DIRECTION IS AFFECTED, ADDITIONAL TRAFFIC CONTROL DEVICES SHALL BE ERRECTED AS DIRECTED BY THE ENGINEER.
5. THE MINIMUM WIDTH OF THE SHOULDER LANE SHALL BE 10 FT.
6. FOR LONG-TERM STATIONARY WORK, EXISTING CONFLICTING PAVEMENT MARKINGS SHALL BE REMOVED AND TEMPORARY MARKINGS SHALL BE INSTALLED BEFORE TRAFFIC PATTERNS ARE CHANGED.
7. IF STAY IN LANE SIGNS ARE USED, THEN SOLID WHITE LANE LINES SHALL BE USED.
8. FOR SHORT-TERM STATIONARY WORK, LANES MAY BE DELINEATED BY CHANNELIZING DEVICES OR REMOVABLE PAVEMENT MARKINGS, INSTEAD OF TEMPORARY PAVEMENT MARKINGS.
9. IF THE SHOULDER CANNOT ADEQUATELY ACCOMMODATE TRUCKS, TRUCKS MAY BE DIRECTED TO USE THE NORMAL TRAVEL LANES.
10. THE USE OF BARRIER SHOULD BE BASED ON ENGINEERING JUDGEMENT.
11. FLASHING WARNING LIGHTS AND/OR FLAGS MAY BE USED TO CALL ATTENTION TO THE ABOVE WARNING SIGNS, AS NEEDED ON THE PLANS, AND/OR AS DIRECTED BY THE ENGINEER.

CASE E8

MULTILANE ONE WAY TRAFFIC OPERATIONS
DAY OR NIGHT OPERATIONS
LANE SHIFT ON FREEWAY/EXPRESSWAY
WHERE AT ANY TIME ANY VEHICLE, EQUIPMENT,
WORKERS OR THEIR ACTIVITIES WILL ENDOURCH
ON ANY PORTION OF THE LANE IMMEDIATELY
ADJACENT TO THE SHOULDER OR MEDIAN.

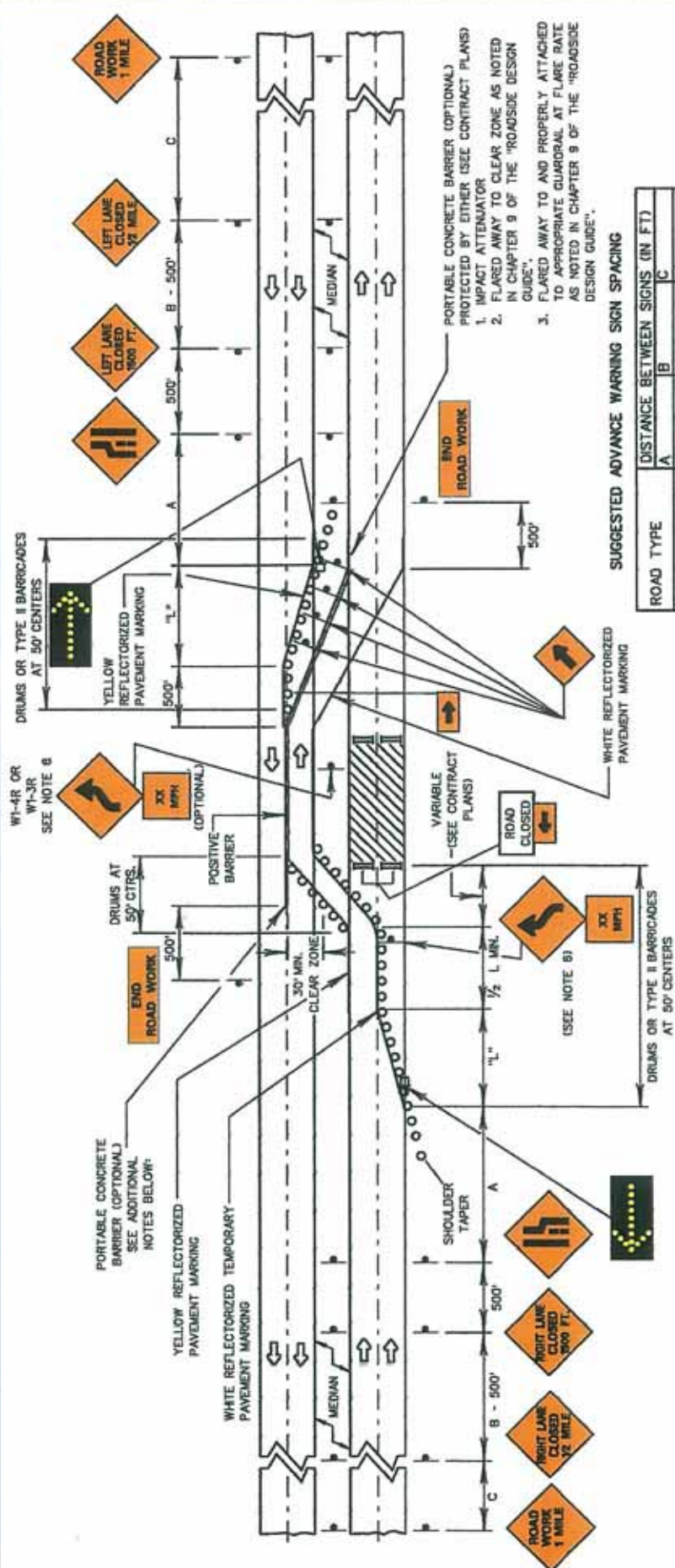

SUGGESTED ADVANCE WARNING SIGN SPACING

ROAD TYPE	A	B	C
URBAN LOW SPEED*	100	100	100
URBAN HIGH SPEED*	350	350	350
RURAL	500	500	500
EXPRESSWAY/FREEWAY	1,000	1,000	2,640

*SPEED CATEGORY TO BE DETERMINED BY WY DOT

GENERAL NOTES

- TEMPORARY PAVEMENT MARKINGS (PAINT OR TAPE) SHALL BE USED WHEN THE CLOSURE TIME EXCEEDS THREE DAYS. TEMPORARY PAVEMENT MARKINGS SHALL BE USED FOR MAKING A NEW CENTER LINE AND EDGE LINE ON THE EXISTING PAVEMENT. ALL EXISTING MARKINGS WHICH CONFLICT WITH THE REVISED TRAFFIC PATTERN WILL BE ERADICATED.
- ALL CROSSOVER PAVEMENT MARKINGS SHALL BE REMOVED WHEN TRAFFIC NO LONGER CROSSES OVER AND/OR AT THE COMPLETION OF THE PROJECT.
- THE "L" DISTANCE EQUALS THE TAPER LENGTH.

NORMAL POSTED SPEED M.P.H.	TAPER LENGTH (FOR 12' CLOSURE) FEET
65	800
60	725
55	650
50	600
45	550
40 OR LESS	350
- CARE MUST BE TAKEN TO INSURE 24 HOUR OPERATION OF THE ELECTRIC ARROW. IT SHALL BE POSITIONED BEHIND THE CHANNELIZATION DEVICES AND SHALL NOT BE AN UNPROTECTED OBJECT TO THE MOTORIST. MINIMUM SHIFT DISTANCE IS 1,000 FT.
- WHEN CROSSOVER SPEED IS GREATER THAN 30 M.P.H., REVERSE CURVE (W1-4) SIGN SHALL BE USED. WHEN SPEED IS 30 M.P.H. OR LESS, REVERSE TURN (W1-3) SIGN SHALL BE USED.
- TWO-WAY TRAFFIC SHALL BE SEPARATED BY A POSITIVE BARRIER, (FOR TYPE - SEE CONTRACT PLANS)
- ALL VEHICLES, EQUIPMENT, WORKERS AND THEIR ACTIVITIES ARE RESTRICTED AT ALL TIMES TO ONE SIDE OF THE MEDIAN.
- THE ALIGNMENT OF THE CROSSOVER MAY BE DESIGNED AS A REVERSE CURVE.
- WHEN CROSSOVER FOLLOWS A CURVED ALIGNMENT, THE DESIGN CRITERIA CONTAINED IN THE ASHTO "POLICY ON THE GEOMETRIC DESIGN OF HIGHWAY AND STREETS" SHOULD BE USED (SEE SECTION 1A.11).
- WHEN CHANNELIZING DEVICES ARE USED TO SEPARATE OPPOSING MOTOR VEHICLE TRAFFIC, ADD DO NOT ENTER, KEEP RIGHT, TWO-WAY TRAFFIC AND DO NOT PASS SIGNS.
- FLASHING WARNING LIGHTS AND/OR FLAGS MAY BE USED TO CALL ATTENTION TO THE ABOVE WARNING SIGNS, AS NEEDED ON THE PLANS, AND/OR AS DIRECTED BY THE ENGINEER.

SYMBOLS

- WORK AREA
- SIGN
- TYPE II BARRICADE
- SIGN ON PORTABLE OR PERMANENT SUPPORT.
- DRUM
- ELECTRIC ARROW.

CASE E9

MULTILANE DIVIDED, TWO-WAY TRAFFIC
 DAY OR NIGHT OPERATIONS
 MEDIAN CROSS OVER ON FREEWAY.
 WHERE AT ANY TIME ANY VEHICLE EQUIPMENT, WORKERS OR THEIR ACTIVITIES REQUIRE THE CLOSURE OF TWO ADJACENT LANES AND A TEMPORARY CROSSOVER IS PROVIDED BY MAKING USE OF ONE LANE OF PAVEMENT NORMALLY USED BY THE OPPOSING FLOW OF TRAFFIC.

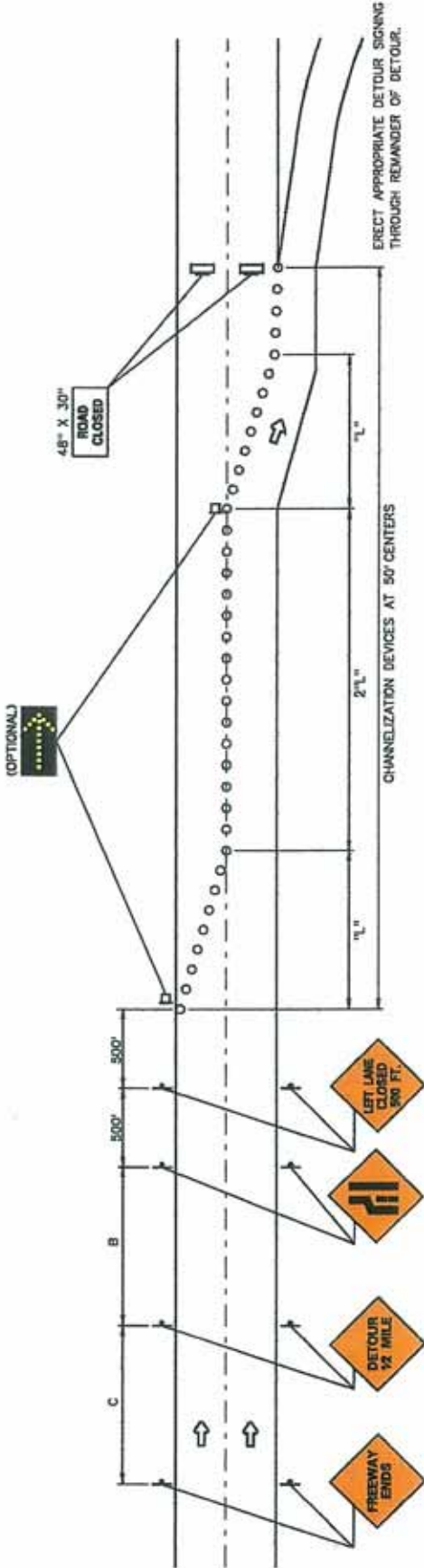

ERECT APPROPRIATE DETOUR SIGNING THROUGH REMAINDER OF DETOUR.

GENERAL NOTES

1. THE "L" DISTANCE EQUALS THE TAPER LENGTH.

NORMAL POSTED SPEED M.P.H.	TAPER LENGTH FEET
65	800
60	725
55	650
50	600
45	550
40 OR LESS	350

- THIS CASE ALSO APPLIES WHEN WORK IS BEING PERFORMED ON MULTILANE UNDIVIDED HIGHWAYS UNDER THESE CONDITIONS THE SIGNS AND WARNING LIGHTS NORMALLY MOUNTED IN THE MEDIAN SHALL BE OMITTED.
- ALL SIGNS EXCEPT FOR THOSE IN ROADWAY SHALL BE POST MOUNTED IF THE CLOSURE TIME EXCEEDS THREE DAYS.
- WHEN A SIDE ROAD INTERSECTS THE HIGHWAY ON WHICH WORK IS BEING PERFORMED ADDITIONAL TRAFFIC CONTROL DEVICES SHALL BE ERRECT AS DIRECTED BY THE ENGINEER.
- WHEN THE ELECTRIC ARROW IS USED CARE MUST BE TAKEN TO INSURE CONTINUOUS OPERATION IT SHALL BE POSITIONED BEHIND THE CHANNELIZATION DEVICES AND SHALL NOT BE AN UNPROTECTED OBJECT TO THE MOTORIST. MINIMUM SIGHT DISTANCE IS 1000 FT.
- FLASHING WARNING LIGHTS AND/OR FLAGS MAY BE USED TO CALL ATTENTION TO THE ABOVE WARNING SIGNS, AS NEEDED ON THE PLANS, AND/OR AS DIRECTED BY THE ENGINEER.

SUGGESTED ADVANCE WARNING SIGN SPACING

ROAD TYPE	DISTANCE BETWEEN SIGNS (IN FT)		
	A	B	C
URBAN (LOW SPEED)*	100	100	100
URBAN (HIGH SPEED)*	350	350	350
RURAL	500	500	500
EXPRESSWAY/FREEWAY	1,000	1,500	2,640

*SPEED CATEGORY TO BE DETERMINED BY WY DCH

SYMBOLS

- SIGN
- SIGN ON PORTABLE OR PERMANENT SUPPORT.
- ELECTRIC ARROW.
- TYPE III BARRICADES.
- CHANNELIZATION DEVICE.

TYPICAL APPLICATIONS

- HAZARDOUS MATERIAL SPILLS
- STRUCTURES COLLAPSE
- OTHER MAJOR INCIDENTS

CASE E10

MULTILANE, ONE WAY TRAFFIC OPERATIONS
DAY OR NIGHT OPERATIONS
FREEWAY/EXPRESSWAY CLOSURES

FOR EMERGENCY USE ONLY

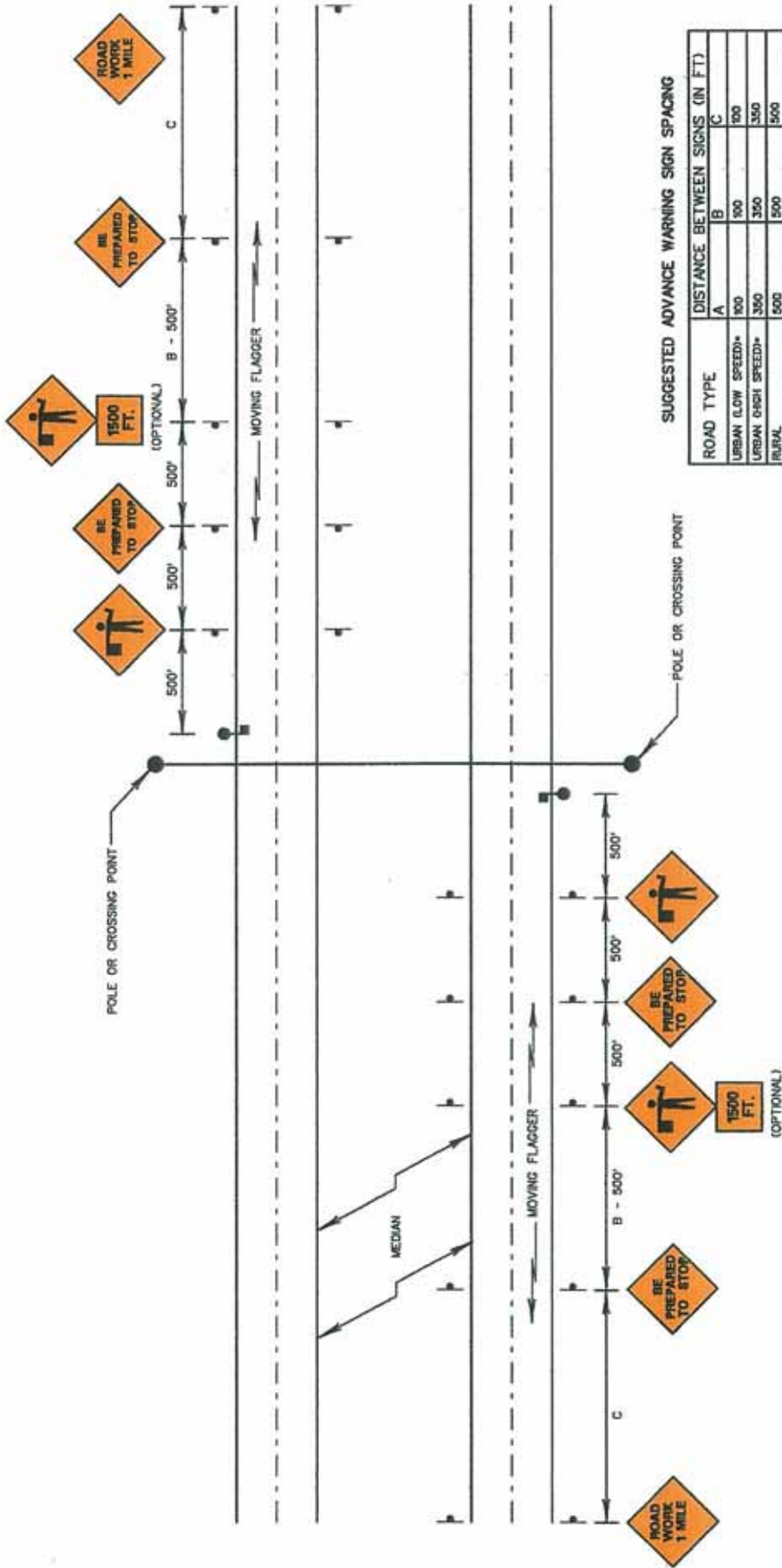

SUGGESTED ADVANCE WARNING SIGN SPACING

ROAD TYPE	A	B	C
URBAN (LOW SPEED)*	100	100	100
URBAN (HIGH SPEED)**	350	350	350
RURAL	500	500	500
EXPRESSWAY/FREEWAY	1,000	1,500	2,640

*SPEED CATEGORY TO BE DETERMINED BY WV DCH

GENERAL NOTES

- THIS CASE ALSO APPLIES WHEN WORK IS BEING PERFORMED ON MULTILANE UNDIVIDED HIGHWAYS, UNDER THESE CONDITIONS THE SIGNS NORMALLY MOUNTED IN THE MEDIAN SHALL BE OMITTED.
- FLASHING WARNING LIGHTS AND/OR FLAGS MAY BE USED TO CALL ATTENTION TO THE ADVANCE WARNING SIGNS AS NOTED ON THE PLANS AND/OR AS DIRECTED BY THE ENGINEER.
- WHEN A SIDE ROAD INTERSECTS THE HIGHWAY ON WHICH WORK IS BEING PERFORMED ADDITIONAL TRAFFIC CONTROL DEVICES SHALL BE ERRECTED AS DIRECTED BY THE ENGINEER.
- THE SITE SHALL BE COMPLETELY PREPARED (SIGNS, DEVICES, WORK EQUIPMENT, ETC.) THEN TRAFFIC STOPPED FOR MAXIMUM OF 15 MINUTES, OR AS OTHERWISE NOTED ON THE PLANS THEN PERIODICALLY PLATOONS OF VEHICLES SHALL BE ALLOWED TO PROCEED FOLLOWED BY OTHER STOPPAGES.
- THIS OPERATION SHALL NORMALLY ONLY OCCUR ON A SUN-DAY MORNING PRIOR TO 1100 AM (OTHER TIMES MUST BE APPROVED BY THE DISTRICT ENGINEER OR TRAFFIC ENGINEERING DIVISION).
- MOVING FLAGGER SPECIAL PROVISION (AS NECESSARY) ALL FLAGGERS SHALL BE FURNISHED BY THE CONTRACTOR AND ALL FLAGGING SHALL BE HIS RESPONSIBILITY. WHERE MOVING FLAGGING IS NOTED OR CALLED FOR, TWO FLAGGERS SHALL BE PROVIDED AT EACH END OF THE AREAS WHERE TRAFFIC IS BEING STOPPED. ONE FLAGGER IS TO BE POSITIONED IN ACCORDANCE WITH THE MANUAL, WHILE THE OTHER FLAGGER IS TO CONTINUALLY MOVE WITH STOPPING TRAFFIC. TWO-WAY RADIOS SHALL BE PROVIDED TO THE FLAGGERS WHEN THEY ARE OUT OF SIGHT OF EACH OTHER.
- FOR SHORT-TERM UTILITY ONLY OPERATIONS IN MEDIAN, SEE CASE C4.

SYMBOLS

- SIGN ON PORTABLE OR PERMANENT SUPPORT.
- FLAGGER WITH PADDLE

TYPICAL APPLICATIONS

- SETTING BRIDGE BEAMS
- SHORT TERM UTILITY OPERATIONS

CASE E11

- MULTILANE
- DAYTIME OPERATIONS
- SHORT TERM UTILITY CROSSINGS

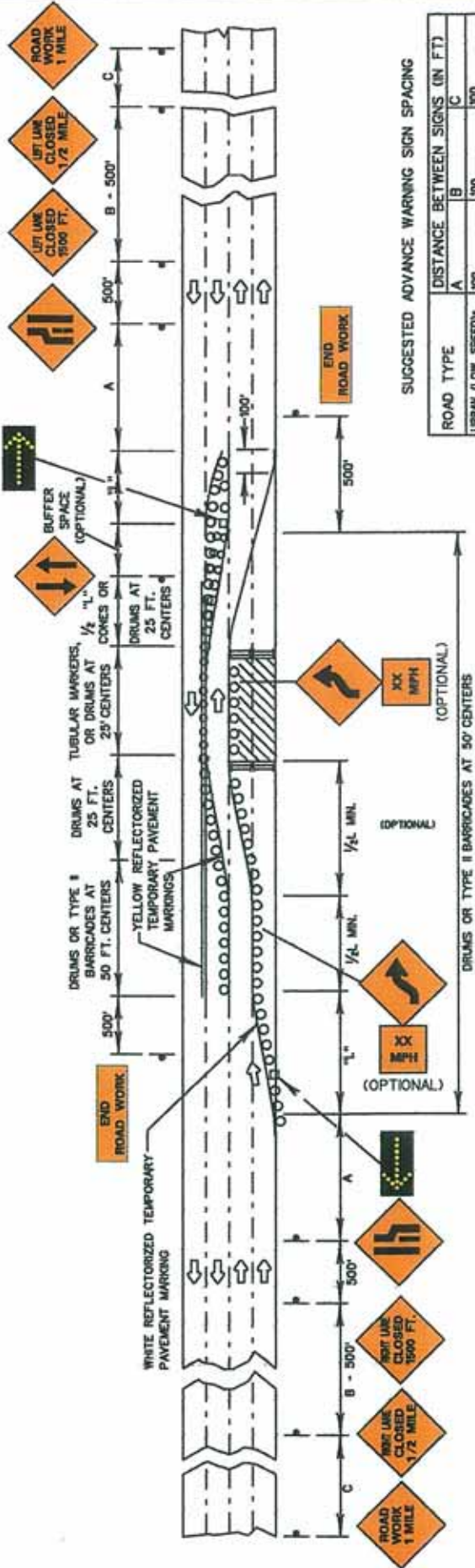

SUGGESTED ADVANCE WARNING SIGN SPACING

ROAD TYPE	A	B	C
URBAN LOW SPEED*	100	100	100
URBAN HIGH SPEED*	350	350	350
RURAL	500	500	500
EXPRESSWAY/FREEWAY	1000	1500	2,040

*SPEED CATEGORY TO BE DETERMINED BY WV DOH

GENERAL NOTES

1. TEMPORARY PAVEMENT MARKINGS (TAPE OR PAINT) SHALL BE USED WHEN THE CLOSURE TIME EXCEEDS THREE DAYS. TEMPORARY PAVEMENT MARKINGS SHALL BE USED FOR MARKING A NEW CENTER LINE AND EDGE LINE ON THE EXISTING PAVEMENT. ALL EXISTING MARKINGS WHICH CONFLICT WITH THE REVISED TRAFFIC PATTERN SHALL BE ERADICATED.
2. ALL CROSSOVER PAVEMENT MARKINGS SHALL BE REMOVED WHEN TRAFFIC NO LONGER CROSSES OVER AND/OR AT THE COMPLETION OF THE PROJECT.
3. CONES MAY BE SUBSTITUTED FOR CHANNELIZING DEVICES FOR DAYTIME ONLY OPERATIONS.
4. THE "L" DISTANCE EQUALS THE TAPER LENGTH.

NORMAL POSTED SPEED M.P.H.	TAPER LENGTH (FOR 12' CLOSURE) FEET
65	800
80	725
55	650
50	600
45	550
40 OR LESS	350
5. CARE MUST BE TAKEN TO ENSURE 24 HOUR OPERATION OF THE ELECTRIC ARROW. IT SHALL BE POSITIONED BEHIND THE CHANNELIZATION DEVICES AND SHALL NOT BE AN UNPROTECTED OBJECT TO THE MOTORIST. MINIMUM SIGHT DISTANCE IS 1,000 FT.
6. ALL SIGNS SHALL BE POST MOUNTED IF THE CLOSURE TIME EXCEEDS THREE DAYS.
7. WHEN A SIDE ROAD INTERSECTS THE HIGHWAY ON WHICH WORK IS BEING PERFORMED ADDITIONAL TRAFFIC CONTROL DEVICES SHALL BE ERECTED AS DIRECTED BY THE ENGINEER.
8. ALL VEHICLES, EQUIPMENT, WORKERS AND THEIR ACTIVITIES ARE RESTRICTED AT ALL TIMES TO ONE SIDE OF THE PAVEMENT UNLESS OTHERWISE AUTHORIZED BY THE ENGINEER.
9. PORTABLE CONCRETE BARRIER MAY BE USED (SEE CONTRACT PLANS) AND IF SO IT WOULD BE PROTECTED BY IMPACT ATTENUATORS AND CONFIGURED AS FOLLOWS:

ATTEN.	TCB	ATTEN.
○	—	○
○	—	○
10. FLASHING WARNING LIGHTS AND/OR FLAGS MAY BE USED TO CALL ATTENTION TO THE ABOVE WARNING SIGNS, AS NEEDED ON THE PLANS, AND/OR AS DIRECTED BY THE ENGINEER.

SYMBOLS

- WORK AREA
- SIGN
- TYPE II BARRICADES.
- SIGN ON PORTABLE OR PERMANENT SUPPORT.
- DRUM.
- ELECTRIC ARROW

CASE E12

MULTILANE, TWO-WAY TRAFFIC, UNOCCUPIED, DAY OR NIGHT OPERATIONS.

WHERE AT ANY TIME ANY VEHICLE, EQUIPMENT, WORKERS OR THEIR ACTIVITIES REQUIRE THE CLOSURE OF TWO ADJACENT LANES AND A TEMPORARY RUNDOWN IS PROVIDED BY MAKING USE OF ONE LANE OF PAVEMENT NORMALLY USED BY THE OPPOSING FLOW OF TRAFFIC.

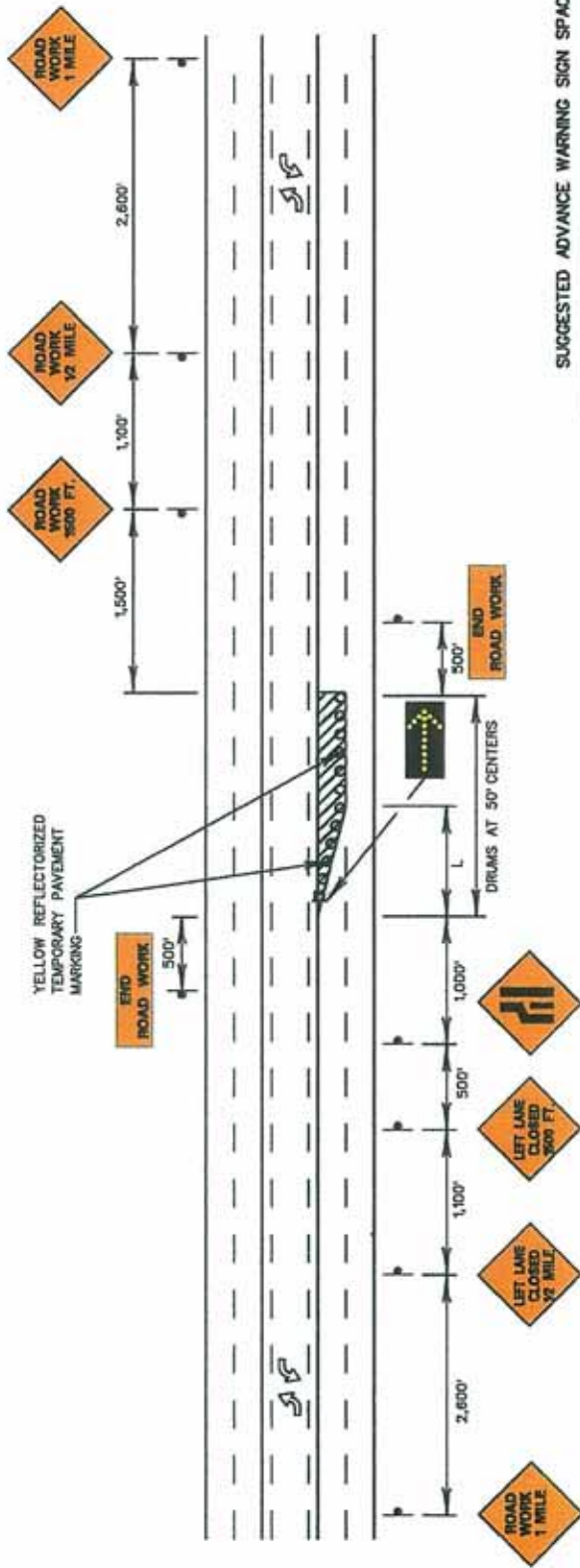

SUGGESTED ADVANCE WARNING SIGN SPACING

ROAD TYPE	DISTANCE BETWEEN SIGNS (IN FT)		
	A	B	C
URBAN (LOW SPEED)*	100	100	100
URBAN (HIGH SPEED)**	300	350	350
RURAL	500	500	500
EXPRESSWAY/FREEWAY	1,000	1,500	2,840

*SPEED CATEGORY TO BE DETERMINED BY WV DDM

GENERAL NOTES

1. THE "L" DISTANCE EQUALS THE TAPER LENGTH.
2. ANY UNATTENDED OBSTACLE OR EXCAVATION IN THE WORK AREA OVERNIGHT SHALL BE PROTECTED BY TYPE I OR TYPE II BARRICADES WITH FLASHING LIGHTS (TYPE 'A').
3. WHEN A SIDE ROAD INTERSECTS THE HIGHWAY ON WHICH WORK IS BEING PERFORMED ADDITIONAL TRAFFIC CONTROL DEVICES SHALL BE ERRECTED AS DIRECTED BY THE ENGINEER.
4. CARE MUST BE TAKEN TO INSURE 24 HOUR OPERATION OF THE ELECTRIC ARROW. IT SHALL BE POSITIONED BEHIND THE CHANNELIZATION DEVICES AND SHALL NOT BE AN UNPROTECTED OBJECT TO THE MOTORIST. MINIMUM SIGHT DISTANCE IS 1,000 FT.
5. REFLECTORIZED TEMPORARY PAVEMENT MARKING MAY BE OMITTED IF CLOSURE TIME IS LESS THAN THREE DAYS.
6. WORK VEHICLE, IF USED, SHALL HAVE DUAL FLASHERS AND FLASHING AMBER DOME LIGHT OPERATING.
7. FLASHING WARNING LIGHTS AND/OR FLAGS MAY BE USED TO CALL ATTENTION TO THE ABOVE WARNING SIGNS, AS NEEDED ON THE PLANS, AND/OR AS DIRECTED BY THE ENGINEER.

NORMAL POSTED SPEED	TAPER LENGTH (FOR 12' CLOSURE)
M.P.H.	FEET
85	800
60	725
55	650
50	600
45	550
40 OR LESS	350

SYMBOLS

- WORK AREA.
- SIGN
- TYPE II BARRICADES.
- SIGN ON PORTABLE OR PERMANENT SUPPORT.
- DRUM
- ELECTRIC ARROW.

CASE E13

FIVE LANE, DOUBLE LEFT TURN LANE,
UNDIVIDED DAY OR NIGHT OPERATIONS
SECOND LANE CLOSED
(OUTSIDE LANE SIMILAR)

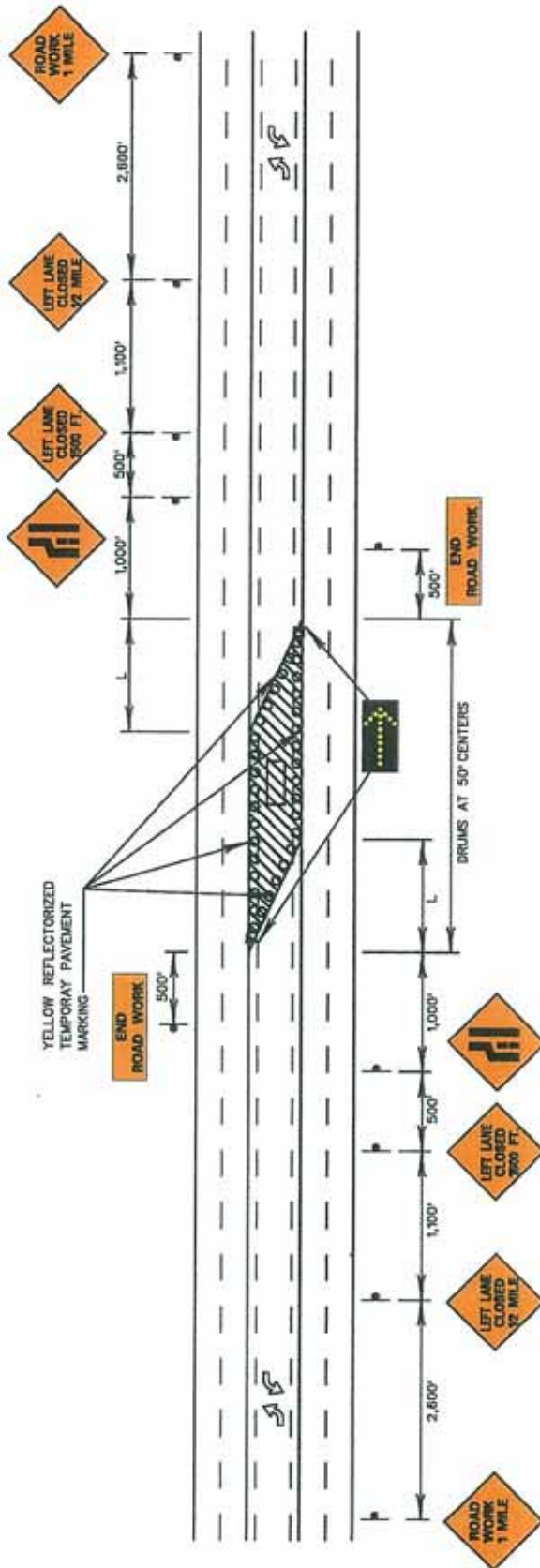

SUGGESTED ADVANCE WARNING SIGN SPACING

ROAD TYPE	DISTANCE BETWEEN SIGNS (IN FT.)		
	A	B	C
URBAN LOW SPEED*	100	100	100
URBAN HIGH SPEED*	350	350	350
RURAL	500	500	500
EXPRESSWAY/FREEWAY	1,000	1,500	2,640

*SPEED CATEGORY TO BE DETERMINED BY WY DOH

GENERAL NOTES

1. THE "L" DISTANCE EQUALS THE TAPER LENGTH.

NORMAL POSTED SPEED	TAPER LENGTH (FOR 12' CLOSURE)
M.P.H.	FEET
65	800
60	725
55	650
50	600
45	550
40 OR LESS	350

- ANY UNATTENDED OBSTACLE OR EXCAVATION IN THE WORK AREA OVERNIGHT SHALL BE PROTECTED BY TYPE I OR TYPE II BARRICADES WITH FLASHING LIGHTS (TYPE 'A').
- WHEN A SIDE ROAD INTERSECTS THE HIGHWAY ON WHICH WORK IS BEING PERFORMED ADDITIONAL TRAFFIC CONTROL DEVICES SHALL BE DIRECTED AS DIRECTED BY THE ENGINEER.
- CARE MUST BE TAKEN TO INSURE 24 HOUR OPERATION OF THE ELECTRIC ARROW. IT SHALL BE POSITIONED BEHIND THE CHANNELIZATION DEVICES AND SHALL NOT BE AN UNPROTECTED OBJECT TO THE MOTORIST. MINIMUM SIGHT DISTANCE IS 1,000 FT.
- REFLECTORIZED TEMPORARY PAVEMENT MARKING MAY BE OMITTED IF CLOSURE TIME IS LESS THAN THREE DAYS.
- WORK VEHICLE, IF USED, SHALL HAVE DUAL FLASHERS AND FLASHING AMBER DOME LIGHT OPERATING.
- FLASHING WARNING LIGHTS AND/OR FLAGS MAY BE USED TO CALL ATTENTION TO THE ABOVE WARNING SIGNS, AS NEEDED ON THE PLANS, AND/OR AS DIRECTED BY THE ENGINEER.

SYMBOLS

- WORK AREA
- SIGN
- TYPE II BARRICADES
- SIGN ON PORTABLE OR PERMANENT SUPPORT
- DRUM
- ELECTRIC ARROW

CASE E14

FIVE LANE, DOUBLE LEFT TURN LANE,
UNDIVIDED DAY OR NIGHT OPERATIONS
MIDDLE LANE CLOSED

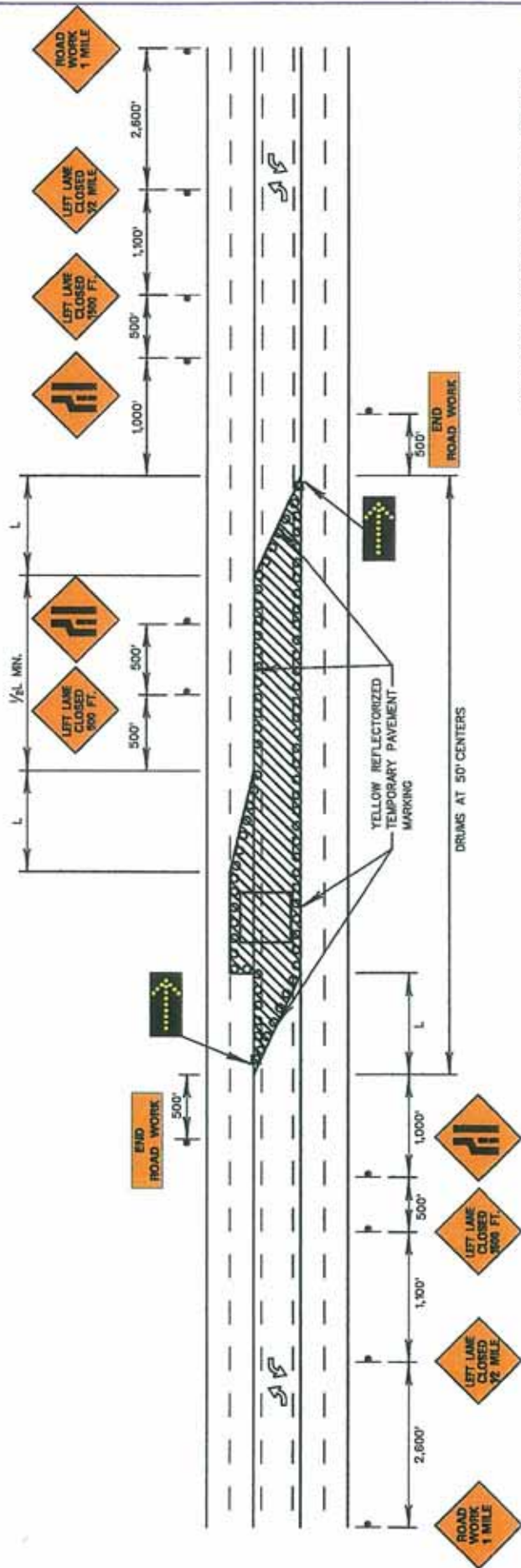

SUGGESTED ADVANCE WARNING SIGN SPACING

ROAD TYPE	A	B	C
URBAN (LOW SPEED)**	100	100	100
URBAN (HIGH SPEED)**	350	350	350
RURAL	500	500	500
EXPRESSWAY/FREEWAY	1,000	1,500	2,640

*SPEED CATEGORY TO BE DETERMINED BY WV DOT

GENERAL NOTES

1. THE "L" DISTANCE EQUALS THE TAPER LENGTH.
 NORMAL POSTED SPEED (FOR 12' CLOSURE)
 M.P.H. FEET
 65 900
 60 725
 55 650
 50 600
 45 550
 40 OR LESS 350
2. ANY UNATTENDED OBSTACLE OR EXCAVATION IN THE WORK AREA OVERNIGHT SHALL BE PROTECTED BY TYPE I OR TYPE II BARRICADES WITH FLASHING LIGHTS (TYPE 'A').
3. WHEN A SIDE ROAD INTERSECTS THE HIGHWAY ON WHICH WORK IS BEING PERFORMED ADDITIONAL TRAFFIC CONTROL DEVICES SHALL BE ERRECTED AS DIRECTED BY THE ENGINEER.
4. CARE MUST BE TAKEN TO INSURE 24 HOUR OPERATION OF THE ELECTRIC ARROW. IT SHALL BE POSITIONED BEHIND THE CHANNELIZATION DEVICES AND SHALL NOT BE AN UNPROTECTED OBJECT TO THE MOTORIST. MINIMUM SIGHT DISTANCE IS 1,000 FT.
5. REFLECTORIZED TEMPORARY PAVEMENT MARKING MAY BE OMITTED IF CLOSURE TIME IS LESS THAN THREE DAYS.
6. WORK VEHICLE, IF USED, SHALL HAVE DUAL FLASHERS AND FLASHING AMBER DOME LIGHT OPERATING.
7. FLASHING WARNING LIGHTS AND/OR FLAGS MAY BE USED TO CALL ATTENTION TO THE ABOVE WARNING SIGNS, AS NEEDED ON THE PLANS, AND/OR AS DIRECTED BY THE ENGINEER.

SYMBOLS

- WORK AREA.
- SIGN
- TYPE II BARRICADES.
- SIGN ON PORTABLE OR PERMANENT SUPPORT.
- DRUM
- ELECTRIC ARROW.

CASE E15

FIVE LANE, DOUBLE LEFT TURN LANE,
 UNDIVIDED
 DAY OR NIGHT OPERATIONS
 MIDDLE LANE AND ONE
 INSIDE LANE CLOSED

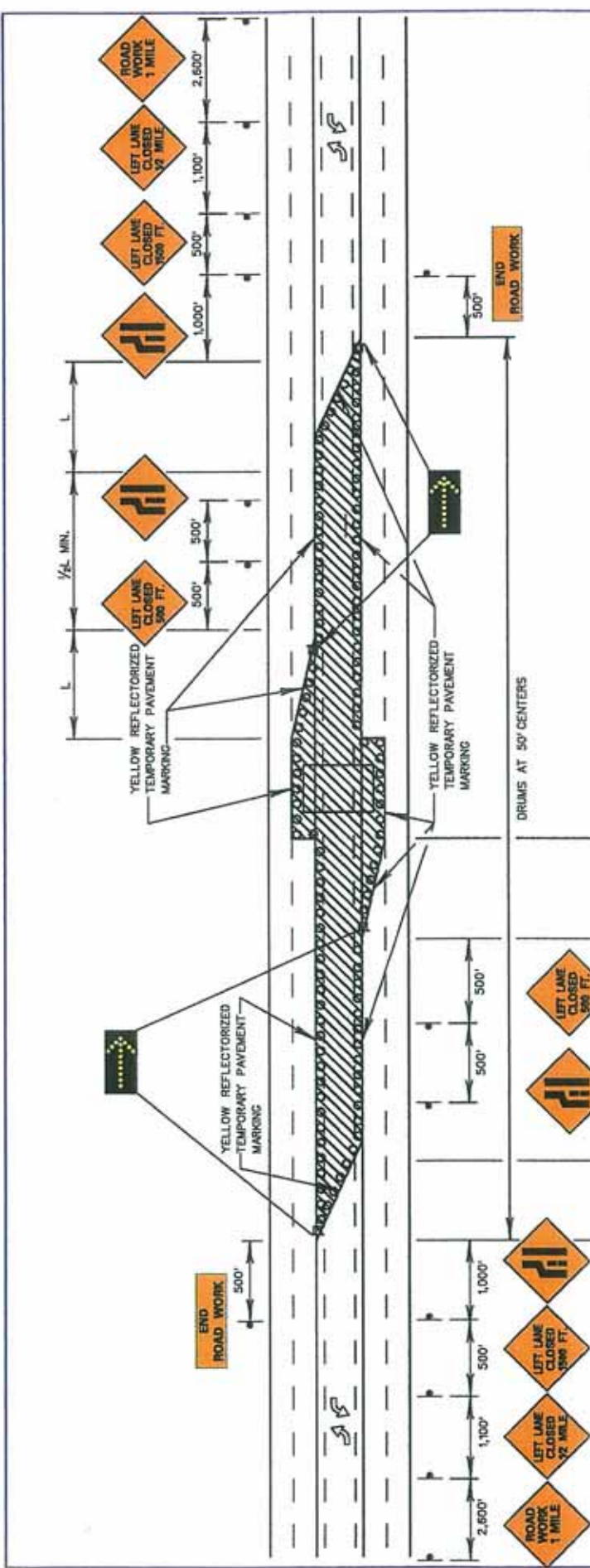

SUGGESTED ADVANCE WARNING SIGN SPACING

ROAD TYPE	A	B	C
URBAN (LOW SPEED)*	100	100	100
URBAN (HIGH SPEED)*	350	350	350
RURAL	500	500	500
EXPRESSWAY/FREEWAY	1,000	1,500	2,640

*SPEED CATEGORY TO BE DETERMINED BY WV DOH

GENERAL NOTES

1. THE "L" DISTANCE EQUALS THE TAPER LENGTH.
2. ANY UNATTENDED OBSTACLE OR EXCAVATION IN THE WORK AREA OVERNIGHT SHALL BE PROTECTED BY TYPE I OR TYPE II BARRICADES WITH FLASHING LIGHTS (TYPE 'A').
3. WHEN A SIDE ROAD INTERSECTS THE HIGHWAY ON WHICH WORK IS BEING PERFORMED ADDITIONAL TRAFFIC CONTROL DEVICES SHALL BE ERRECTED AS DIRECTED BY THE ENGINEER.
4. CARE MUST BE TAKEN TO INSURE 24 HOUR OPERATION OF THE ELECTRIC ARROW. IT SHALL BE POSITIONED BEHIND THE CHANNELIZATION DEVICES AND SHALL NOT BE AN UNPROTECTED OBJECT TO THE MOTORIST. MINIMUM SIGHT DISTANCE IS 1,000 FT.
5. REFLECTORIZED TEMPORARY PAVEMENT MARKING MAY BE OMITTED IF CLOSURE TIME IS LESS THAN THREE DAYS.
6. WORK VEHICLE, IF USED, SHALL HAVE DUAL FLASHERS AND FLASHING AMBER DOME LIGHT OPERATING.
7. FLASHING WARNING LIGHTS AND/OR FLAGS MAY BE USED TO CALL ATTENTION TO THE ABOVE WARNING SIGNS, AS NEEDED ON THE PLANS, AND/OR AS DIRECTED BY THE ENGINEER.

SYMBOLS

- WORK AREA.
- SIGN
- TYPE II BARRICADES.
- SIGN ON PORTABLE OR PERMANENT SUPPORT.
- DRUM
- ELECTRIC ARROW.

CASE E16

FIVE LANE, DOUBLE LEFT TURN LANE UNDIVIDED DAY OR NIGHT OPERATIONS MIDDLE LANE AND BOTH INSIDE LANES CLOSED

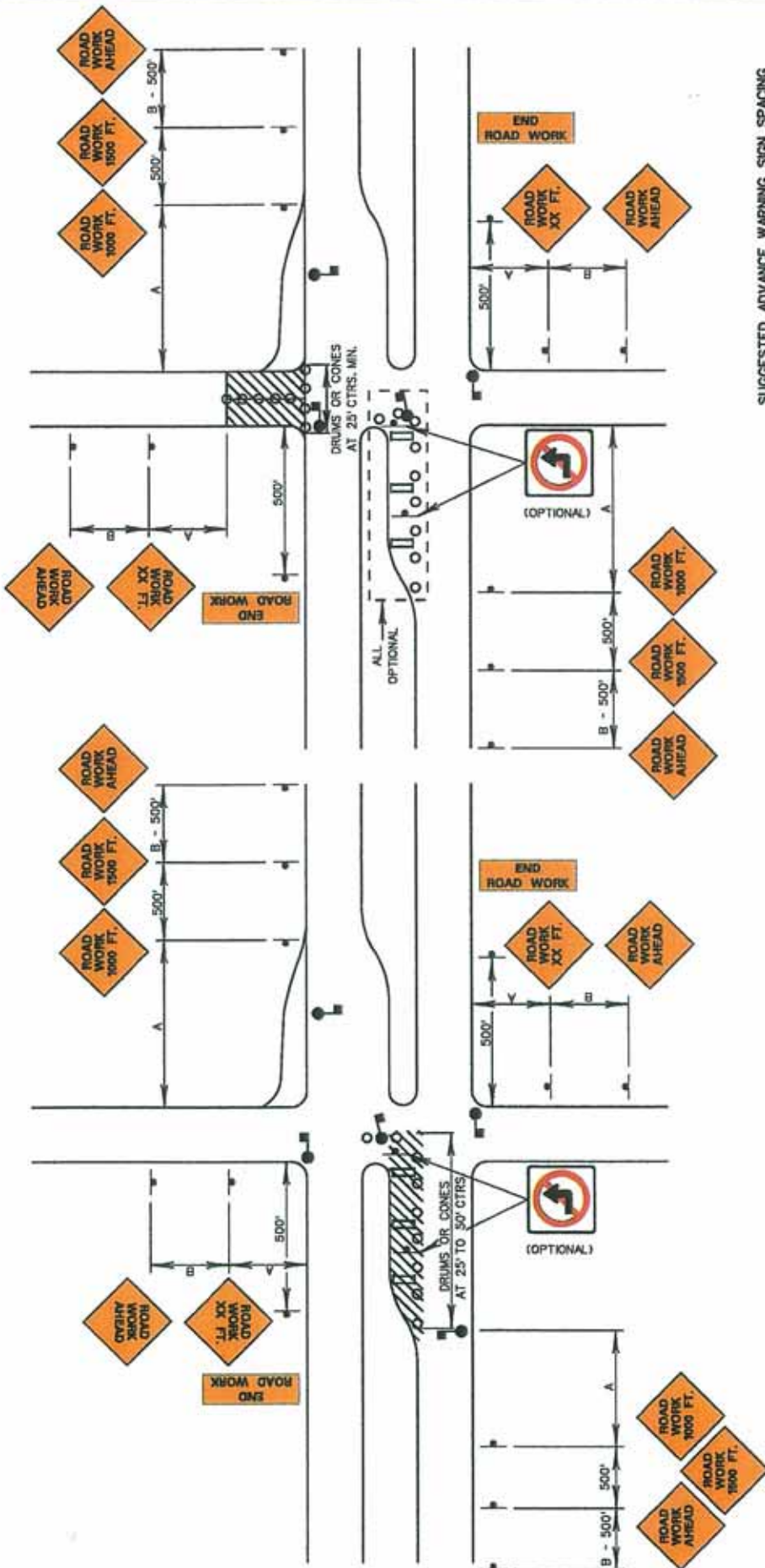

SUGGESTED ADVANCE WARNING SIGN SPACING

ROAD TYPE	DISTANCE BETWEEN SIGNS (IN FT)		
	A	B	C
URBAN LOW SPEED**	100	100	100
URBAN HIGH SPEED**	350	350	350
RURAL	500	500	500
EXPRESSWAY/FREEWAY	1,000	1,500	2,640

*SPEED CATEGORY TO BE DETERMINED BY WV DOH

GENERAL NOTES

1. ALL SIGNS SHALL BE POST MOUNTED IF THE CLOSURE TIME EXCEEDS THREE DAYS.
2. ANY UNATTENDED OBSTACLE OR EXCAVATION IN THE WORK AREA OVERNIGHT SHALL BE PROTECTED BY TYPE 10R TYPE II BARRICADES WITH FLASHING LIGHTS (TYPE 'A').
3. WORK VEHICLE, IF USED, SHALL HAVE DUAL FLASHERS AND FLASHING AMBER DOME LIGHT OPERATING.
4. FLAGGER POSITIONS ARE WORST CASE, APPLY AS NECESSARY.
5. FOR MEDIAN OVER 30 FT, DEPENDING UPON WORK LOCATION, MAY ONLY NEED DEVICES IN ONE DIRECTION.
6. FLASHING WARNING LIGHTS AND/OR FLAGS MAY BE USED TO CALL ATTENTION TO THE ABOVE WARNING SIGNS, AS NEEDED ON THE PLANS, AND/OR AS DIRECTED BY THE ENGINEER.

SYMBOLS

- WORK AREA
- SIGN
- TYPE II BARRICADES.
- SIGN ON PORTABLE OR PERMANENT SUPPORT.
- DRUM
- FLAGGER AND ADVANCE FLAGGER SIGNS AS REQUIRED

TYPICAL APPLICATIONS

- EXPRESSWAY - SIDEROAD CONSTRUCTION
- EXPRESSWAY - LEFT TURN LANE CONSTRUCTION
- EXPRESSWAY - SIDEROAD AND TURN LANE CONSTRUCTION

CASE E17

MULTILANE DIVIDED - SIGNIFICANT SIDE ROADS
DAY OR NIGHT OPERATIONS
FOR TURNING LANE AND OR
SIDE ROAD OPERATIONS

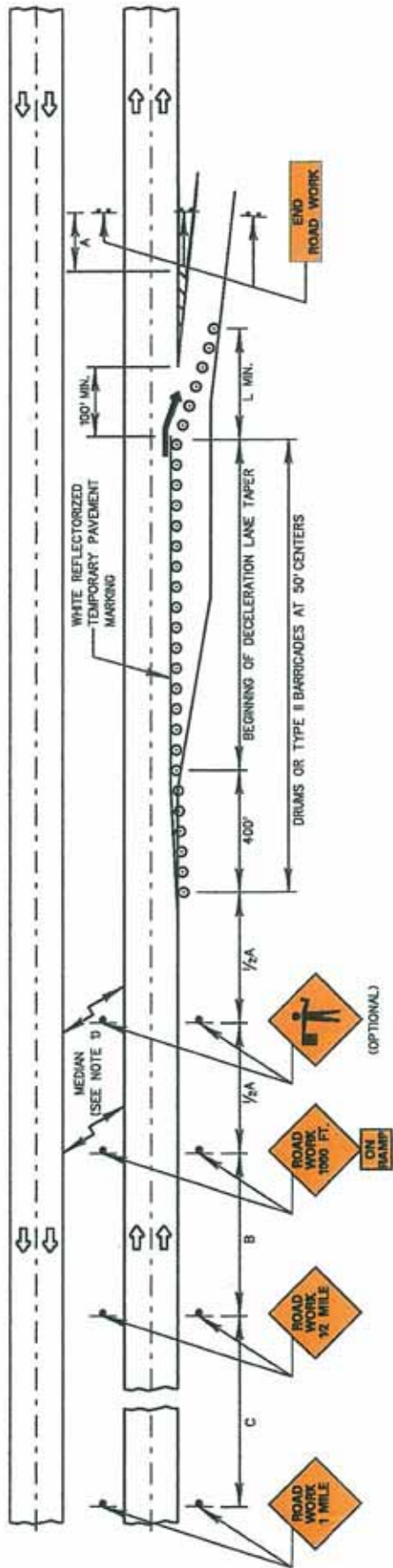

SUGGESTED ADVANCE WARNING SIGN SPACING

ROAD TYPE	DISTANCE BETWEEN SIGNS (IN FT)		
	A	B	C
URBAN (LOW SPEED)*	100	100	100
URBAN (HIGH SPEED)*	350	350	350
RURAL	500	500	500
EXPRESSWAY/FREEWAY	1,000	1,500	2,640

*SPEED CATEGORY TO BE DETERMINED BY WV DOH

SYMBOLS

- WORK AREA
- SIGN
- SIGN ON PORTABLE OR PERMANENT SUPPORT.
- CHANNELIZATION DEVICE

GENERAL NOTES

1. THIS CASE APPLIES WHEN WORK IS BEING PERFORMED ON A MULTILANE UNDIVIDED HIGHWAY UNDER THESE CONDITIONS THE SIGNS NORMALLY MOUNTED IN THE MEDIAN SHALL BE OMITTED.
2. ALL SIGNS SHALL BE POST MOUNTED IF THE CLOSURE TIME EXCEEDS THREE DAYS.
3. REFLECTORIZED TEMPORARY PAVEMENT MARKING MAY BE OMITTED IF CLOSURE TIME IS LESS THAN THREE DAYS.
4. ALL VEHICLES, EQUIPMENT, WORKERS AND THEIR ACTIVITIES ARE RESTRICTED AT ALL TIMES TO ONE SIDE OF THE PAVEMENT UNLESS OTHERWISE AUTHORIZED BY THE ENGINEER.
5. FLASHING WARNING LIGHTS AND/OR FLAGS MAY BE USED TO CALL ATTENTION TO THE ABOVE WARNING SIGNS, AS NEEDED ON THE PLANS, AND/OR AS DIRECTED BY THE ENGINEER.

TYPICAL APPLICATIONS

- PAVEMENT REPAIR
- BRIDGE DECK REPAIR

CASE F1

MULTILANE, DIVIDED OPERATION
 WHERE AT ANY TIME ANY VEHICLE,
 EQUIPMENT, WORKERS OR THEIR
 ACTIVITIES WILL ENCRDACH ON
 ANY PORTION OF THE DECELERATION
 LANE OR THE SHOULDER WITHIN
 2 FEET OF THE EDGE OF MAINLINE.

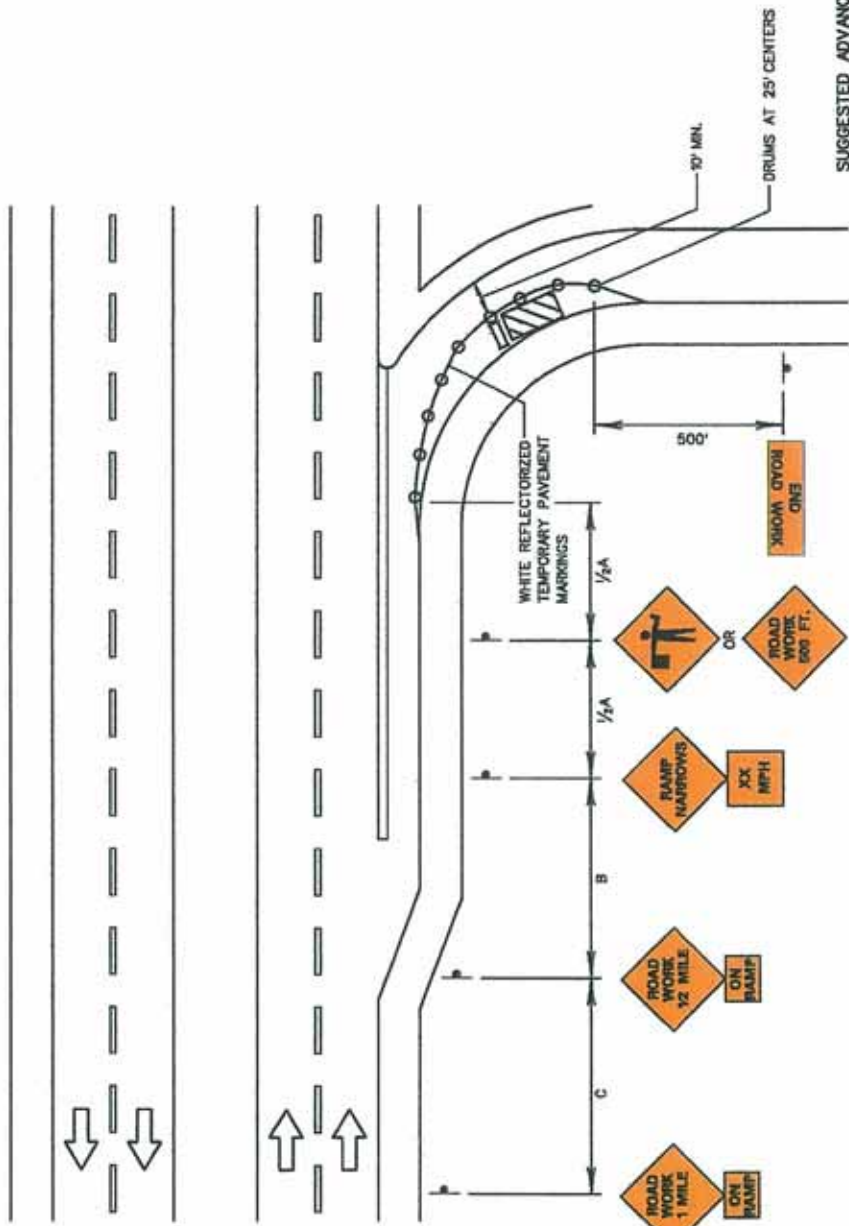

SUGGESTED ADVANCE WARNING SIGN SPACING

ROAD TYPE	DISTANCE BETWEEN SIGNS (IN FT)		
	A	B	C
URBAN LOW SPEED*	100	100	100
URBAN HIGH SPEED*	350	350	350
RURAL	500	500	500
EXPRESSWAY/FREEWAY	1000	1500	2,040

*SPEED CATEGORY TO BE DETERMINED BY WV DMV

CASE F2

WHERE AT ANY TIME ANY VEHICLE, EQUIPMENT, WORKERS OR THEIR ACTIVITIES WILL ENCRUCH ON ANY PORTION OF THE RAMP OR ON THE RAMP SHOULDER WITHIN 2 FEET OF THE EDGE OF THE RAMP.

GENERAL NOTES

1. CONES MAY BE SUBSTITUTED FOR CHANNELIZING DEVICES DURING DAY OPERATIONS.
2. ALL SIGNS SHALL BE POST MOUNTED IF THE CLOSURE TIME EXCEEDS THREE DAYS.
3. REFLECTORIZED TEMPORARY PAVEMENT MARKING MAY BE OMITTED IF CLOSURE TIME IS LESS THAN THREE DAYS.
4. TRUCK OFF-TRACKING SHOULD BE CONSIDERED WHEN DETERMINING WHETHER THE MINIMUM LANE WIDTH OF 10 FT. IS ADEQUATE.
5. FLASHING WARNING LIGHTS AND/OR FLAGS MAY BE USED TO CALL ATTENTION TO THE ABOVE WARNING SIGNS, AS NEEDED ON THE PLANS, AND/OR AS DIRECTED BY THE ENGINEER.

SYMBOLS

- WORK AREA.
- SIGN
- TYPE # BARRICADES.
- SIGN ON PORTABLE OR PERMANENT SUPPORT.
- DRUM

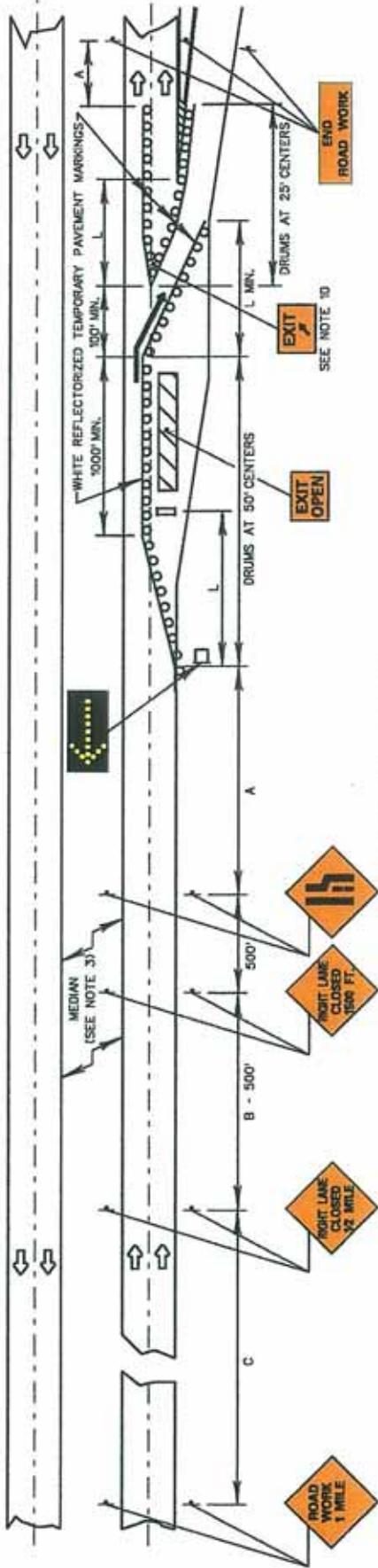

GENERAL NOTES

1. THE "L" DISTANCE EQUALS THE TAPER LENGTH.

NORMAL POSTED SPEED M.P.H.	TAPER LENGTH (FOR 12' CLOSURE) FEET
65	900
60	725
55	650
50	600
45	550
40 OR LESS	350

SYMBOLS

- WORK AREA.
- SIGN
- TYPE III BARRICADES.
- SIGN ON PORTABLE OR PERMANENT SUPPORT.
- DRUM
- ELECTRIC ARROW

SUGGESTED ADVANCE WARNING SIGN SPACING

ROAD TYPE	DISTANCE BETWEEN SIGNS (ON FT)		
	A	B	C
URBAN LOW SPEED*	100	100	100
URBAN HIGH SPEED*	350	350	350
RURAL	500	500	500
EXPRESSWAY/FREEWAY	1,000	1,500	2,640

*SPEED CATEGORY TO BE DETERMINED BY WV DOH

2. A TEMPORARY EXIT SIGN SHALL BE LOCATED IN THE TEMPORARY GORE. FOR BETTER VISIBILITY, IT SHALL BE MOUNTED A MINIMUM OF 7 FT. FROM THE PAVEMENT SURFACE TO THE BOTTOM OF THE SIGN.
3. CONES MAY BE SUBSTITUTED FOR CHANNELIZING DEVICES DURING DAY OPERATIONS.
4. THIS CASE ALSO APPLIES WHEN WORK IS BEING PERFORMED ON A MULTILANE UNDIVIDED HIGHWAY. UNDER THESE CONDITIONS THE SIGNS NORMALLY MOUNTED IN THE MEDIAN SHALL BE OMITTED.
5. ALL SIGNS SHALL BE POST MOUNTED IF THE CLOSURE TIME EXCEEDS THREE DAYS.
6. REFLECTORIZED TEMPORARY PAVEMENT MARKING MAY BE OMITTED IF CLOSURE TIME IS LESS THAN THREE DAYS.
7. ALL VEHICLES, EQUIPMENT, WORKERS AND THEIR ACTIVITIES ARE RESTRICTED AT ALL TIMES TO ONE SIDE OF THE PAVEMENT UNLESS OTHERWISE AUTHORIZED BY THE ENGINEER.
8. WHEN ELECTRIC ARROW IS USED CARE MUST BE TAKEN TO INSURE 24 HOUR OPERATION. IT SHALL BE POSITIONED BEHIND THE CHANNELIZATION DEVICES AND SHALL NOT BE AN UNPROTECTED OBJECT TO THE MOTORIST. MINIMUM SIGHT DISTANCE SHALL BE 1000 FT.
9. FLASHING WARNING LIGHTS AND/OR FLAGS MAY BE USED TO CALL ATTENTION TO THE ABOVE WARNING SIGNS, AS NEEDED ON THE PLANS, AND/OR AS DIRECTED BY THE ENGINEER.
10. THE TEMPORARY EXIT SIGN PLACED IN THE TEMPORARY GORE MAY BE EITHER BLACK ON ORANGE OR WHITE ON GREEN.

TYPICAL APPLICATIONS

PAVEMENT REPAIR

CASE F3

MULTILANE, DIVIDED OPERATION
 WHERE AT ANY TIME ANY VEHICLE,
 EQUIPMENT, WORKERS OR THEIR ACTIVITIES
 WILL ENCRUCH ON ANY PORTION OF THE
 LANE IMMEDIATELY ADJACENT TO THE
 DECELERATION LANE.

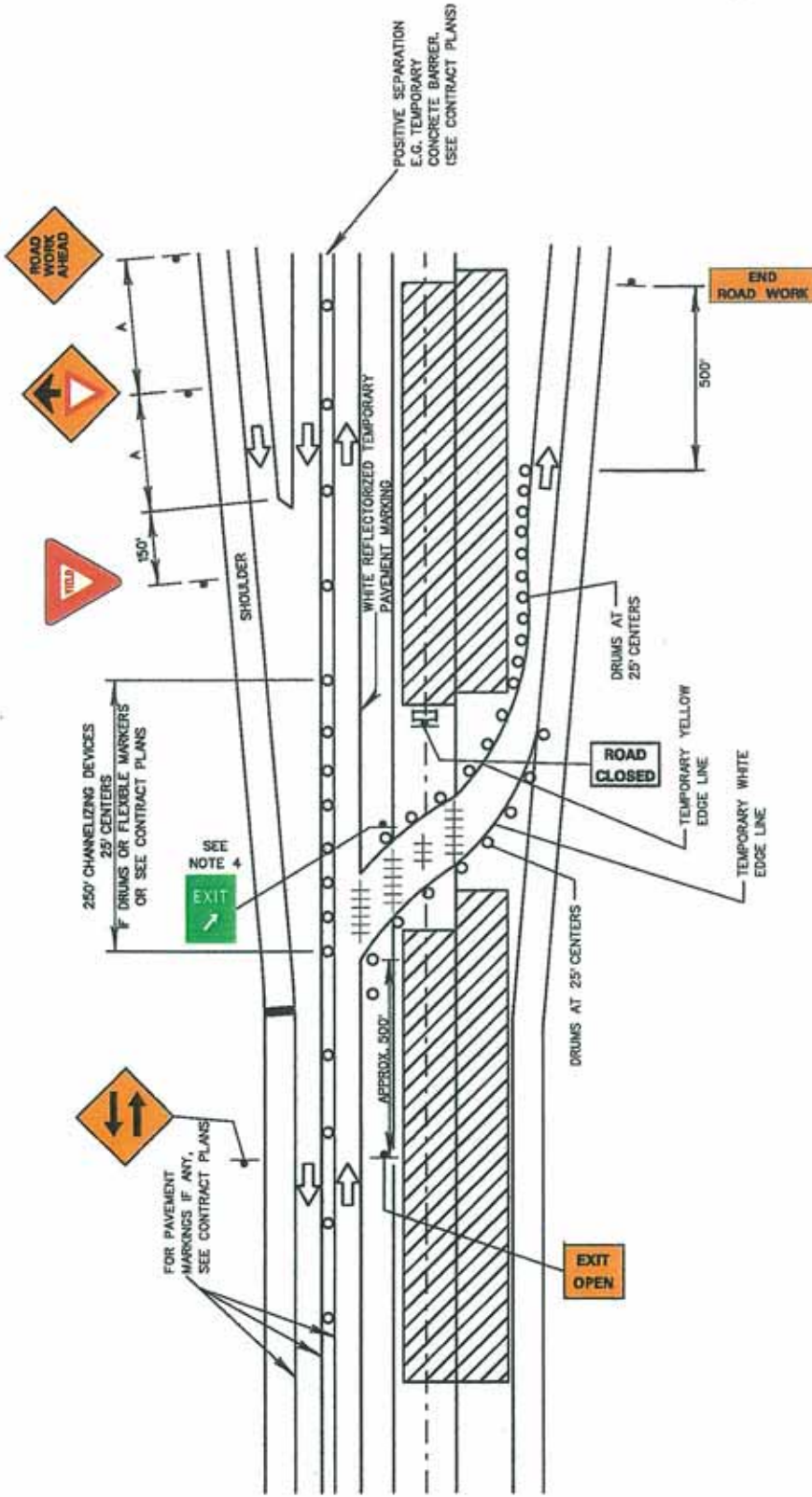

SUGGESTED ADVANCE WARNING SIGN SPACING

ROAD TYPE	DISTANCE BETWEEN SIGNS (IN FT)		
	A	B	C
URBAN (LOW SPEED)*	100	100	100
URBAN (HIGH SPEED)*	350	350	350
RURAL	500	500	500
EXPRESSWAY/FREEWAY	1,000	1,500	2,040

*SPEED CATEGORY TO BE DETERMINED BY WV DOH

CASE F 4

MEDIAN CROSSOVER FOR EXIT RAMP
MULTILANE, DIVIDED HIGHWAY TRAFFIC
ON ONE SIDE (TWO-LANE, TWO-WAY)

GENERAL NOTES

1. ALL VEHICLES, EQUIPMENT, WORKERS AND THEIR ACTIVITIES ARE RESTRICTED AT ALL TIMES TO ONE SIDE OF THE PAVEMENT UNLESS OTHERWISE AUTHORIZED BY THE ENGINEER.
2. A TEMPORARY EXIT SIGN SHALL BE LOCATED IN THE TEMPORARY GORE. FOR BETTER VISIBILITY, IT SHALL BE MOUNTED A MINIMUM OF 7 FT. FROM THE PAVEMENT SURFACE TO THE BOTTOM OF THE SIGN.
3. ADVANCE GUIDE SIGNS PROVIDING INFORMATION RELATED TO THE TEMPORARY EXIT SHOULD BE RELOCATED OR DUPLICATED ADJACENT TO THE TEMPORARY ROADWAY (E.G. THE MEDIAN).
4. THE TEMPORARY EXIT SIGN PLACED IN THE TEMPORARY CORE MAY BE EITHER BLACK ON ORANGE OR WHITE ON GREEN.

SYMBOLS

- WORK AREA.
- SIGN
- TYPE II BARRICADES.
- SIGN ON PORTABLE OR PERMANENT SUPPORT.
- DRUM
- ERADICATION

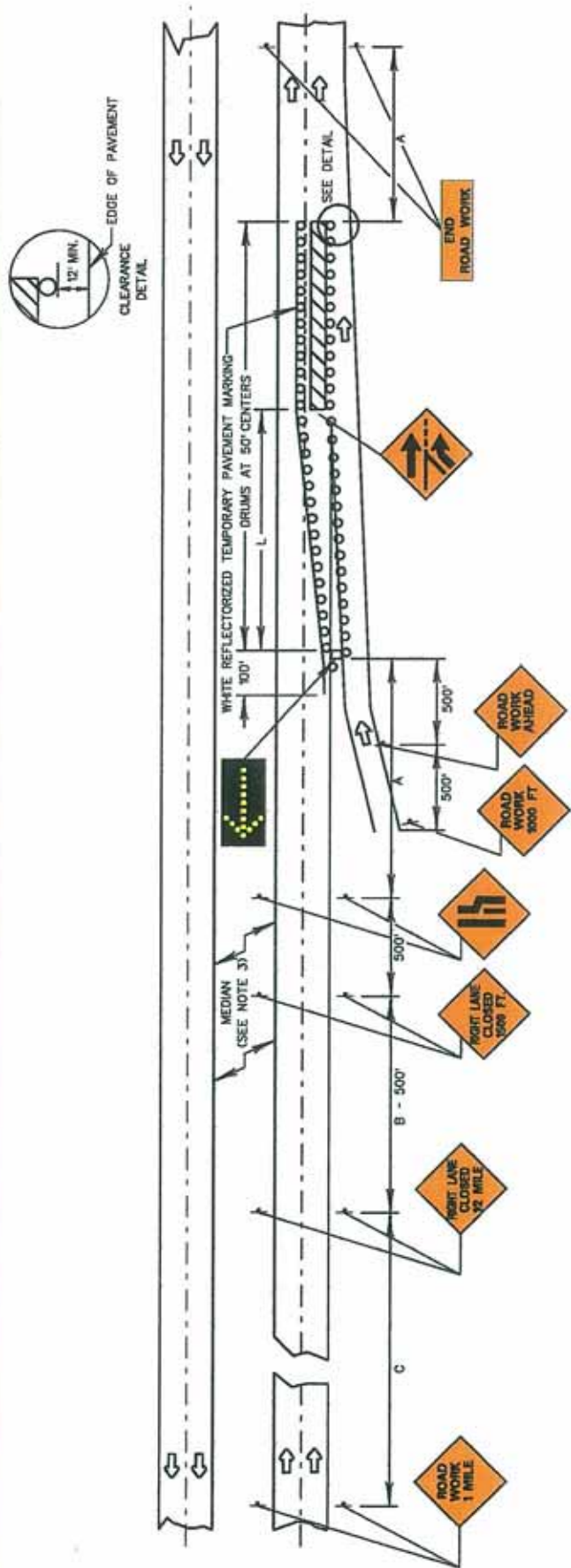

GENERAL NOTES

1. THE "L" DISTANCE EQUALS THE TAPER LENGTH.
2. CONES MAY BE SUBSTITUTED FOR CHANNELIZING DEVICES DURING DAY OPERATIONS.
3. THIS CASE ALSO APPLIES WHEN WORK IS BEING PERFORMED ON A MULTILANE UNDIVIDED HIGHWAY UNDER THESE CONDITIONS. THE SIGNS NORMALLY MOUNTED IN THE MEDIAN SHALL BE OMITTED.
4. ALL SIGNS SHALL BE POST MOUNTED IF THE CLOSURE TIME EXCEEDS THREE DAYS.
5. REFLECTORIZED TEMPORARY PAVEMENT MARKING MAY BE OMITTED IF CLOSURE TIME IS LESS THAN THREE DAYS.
6. ALL VEHICLES, EQUIPMENT, WORKERS AND THEIR ACTIVITIES ARE RESTRICTED AT ALL TIMES TO ONE SIDE OF THE PAVEMENT UNLESS OTHERWISE AUTHORIZED BY THE ENGINEER.
7. WHEN ELECTRIC ARROW IS USED CARE MUST BE TAKEN TO INSURE 24 HOUR OPERATION. IT SHALL BE POSITIONED BEHIND THE CHANNELIZATION DEVICES AND SHALL NOT BE AN UNPROTECTED OBJECT TO THE MOTORIST. MINIMUM SIGHT DISTANCE SHALL BE 1000 FT.
8. FLASHING WARNING LIGHTS AND/OR FLAGS MAY BE USED TO CALL ATTENTION TO THE ABOVE WARNING SIGNS, AS NEEDED ON THE PLANS, AND/OR AS DIRECTED BY THE ENGINEER.

SYMBOLS

- WORK AREA
- SIGN
- SIGN ON PORTABLE OR PERMANENT SUPPORT.
- DRUM
- ELECTRIC ARROW

SUGGESTED ADVANCE WARNING SIGN SPACING

ROAD TYPE	A	B	C
URBAN LOW SPEED*	100	100	100
URBAN HIGH SPEED*	350	350	350
RURAL	500	500	500
EXPRESSWAY/TREXWAY	1,000	1,500	2,840

*SPEED CATEGORY TO BE DETERMINED BY WV DOH

CASE F5

MULTILANE, DIVIDED OPERATION
 WHERE AT ANY TIME ANY VEHICLE, EQUIPMENT, WORKERS OR THEIR ACTIVITIES WILL ENCRACH ON ANY PORTION OF THE LANE IMMEDIATELY ADJACENT TO THE ACCELERATION LANE.

TYPICAL APPLICATIONS

PAVEMENT REPAIR

WHITE REFLECTORIZED TEMPORARY PAVEMENT MARKING

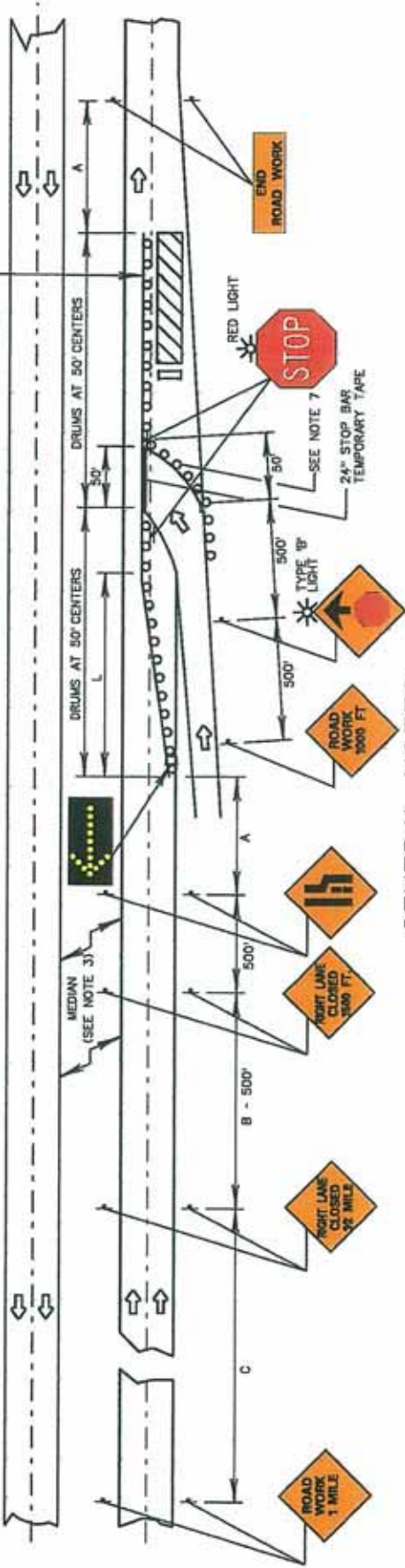

GENERAL NOTES

1. THE "L" DISTANCE EQUALS THE TAPER LENGTH.

NORMAL POSTED SPEED M.P.H.	TAPER LENGTH (FOR 12' CLOSURE) FEET
65	800
60	725
55	650
50	600
45	550
40 OR LESS	350

2. WHEN USED, THE STOP SIGN SHOULD BE LOCATED SO THAT RAMP MOTOR VEHICLE TRAFFIC HAS ADEQUATE SIGHT DISTANCE OF ON-COMING MANLINE MOTOR VEHICLE TRAFFIC TO SELECT A SAFE GAP IN THE MANLINE MOTOR VEHICLE TRAFFIC FLOW. IF INSUFFICIENT GAPS ARE AVAILABLE, CONSIDERATION SHOULD BE GIVEN TO CLOSING THE RAMP.

3. CONES MAY BE SUBSTITUTED FOR CHANNELIZING DEVICES DURING DAY OPERATIONS.

4. THIS CASE ALSO APPLIES WHEN WORK IS BEING PERFORMED ON A MULTILANE UNDIVIDED HIGHWAY UNDER THESE CONDITIONS THE SIGNS NORMALLY MOUNTED IN THE MEDIAN SHALL BE OMITTED.

5. ALL SIGNS SHALL BE POST MOUNTED IF THE CLOSURE TIME EXCEEDS THREE DAYS.

6. REFLECTORIZED TEMPORARY PAVEMENT MARKING MAY BE OMITTED IF CLOSURE TIME IS LESS THAN THREE DAYS.

7. CONES OR DRUMS SHALL BE SPACED AT 10 FOOT CENTERS ALONG THE LAST 100 FT. OF MANLINE AND ON RAMP.

8. ALL VEHICLES, EQUIPMENT, WORKERS AND THEIR ACTIVITIES ARE RESTRICTED AT ALL TIMES TO ONE SIDE OF THE PAVEMENT UNLESS OTHERWISE AUTHORIZED BY THE ENGINEER.

9. WHEN ELECTRIC ARROW IS USED CARE MUST BE TAKEN TO INSURE 24 HOUR OPERATION. IT SHALL BE POSITIONED BEHIND THE CHANNELIZATION DEVICES AND SHALL NOT BE AN UNPROTECTED OBJECT TO THE MOTORIST. MINIMUM SIGHT DISTANCE SHALL BE 1000 FT.

10. FLASHING WARNING LIGHTS AND/OR FLAGS MAY BE USED TO CALL ATTENTION TO THE ABOVE WARNING SIGNS, AS NEEDED ON THE PLANS, AND/OR AS DIRECTED BY THE ENGINEER.

SYMBOLS

- WORK AREA.
- SIGN
- SIGN ON PORTABLE OR PERMANENT SUPPORT.
- DRUM
- ELECTRIC ARROW
- TYPE II BARRICADE

SUGGESTED ADVANCE WARNING SIGN SPACING

ROAD TYPE	DISTANCE BETWEEN SIGNS (IN FT.)		
	A	B	C
URBAN LOW SPEED*	100	100	100
URBAN HIGH SPEED*	350	350	350
RURAL	800	800	1000
EXPRESSWAY/FREEWAY	1,000	1,500	2,640

*SPEED CATEGORY TO BE DETERMINED BY WY DOH

CASE F6

MULTILANE, DIVIDED OPERATION

WHERE AT ANY TIME ANY VEHICLE, EQUIPMENT, WORKERS OR THEIR ACTIVITIES WILL ENCRUCH ON ANY PORTION OF THE LANE IMMEDIATELY ADJACENT TO THE ACCELERATION LANE OR ON THE ACCELERATION LANE WITHIN 2 FT. OF THE EDGE OF PAVEMENT.

TYPICAL APPLICATIONS

PAVEMENT REPAIR



GENERAL NOTES

1. THE "L" DISTANCE EQUALS THE TAPER LENGTH.
- | NORMAL POSTED SPEED | TAPER LENGTH (FOR 12' CLOSED) |
|---------------------|-------------------------------|
| M.P.H. | FEET |
| 65 | 800 |
| 60 | 725 |
| 55 | 650 |
| 50 | 600 |
| 45 | 550 |
| 40 OR LESS | 350 |

SUGGESTED ADVANCE WARNING SIGN SPACING

ROAD TYPE	DISTANCE BETWEEN SIGNS (IN FT)		
	A	B	C
URBAN (LOW SPEED)*	100	100	100
URBAN (HIGH SPEED)*	350	350	350
RURAL	500	500	500
EXPRESSWAY/FREIWAY	1,000	1,500	2,540

*SPEED CATEGORY TO BE DETERMINED BY WV DOH

SYMBOLS

- WORK AREA
- SIGN
- TYPE III BARRICADES
- SIGN ON PORTABLE OR PERMANENT SUPPORT
- DRUM
- ELECTRIC ARROW

2. WHEN USED, THE YIELD SIGN SHOULD BE LOCATED SO THAT RAMP MOTOR VEHICLE TRAFFIC HAS ADEQUATE SIGHT DISTANCE OF ON-COMING MAINLINE MOTOR VEHICLE TRAFFIC TO SELECT A SAFE GAP IN THE MAINLINE MOTOR VEHICLE TRAFFIC FLOW. IF INSUFFICIENT GAPS ARE AVAILABLE, CONSIDERATION SHOULD BE GIVEN TO CLOSING THE RAMP.
3. CONES MAY BE SUBSTITUTED FOR CHANNELIZING DEVICES DURING DAY OPERATIONS.
4. THIS CASE ALSO APPLIES WHEN WORK IS BEING PERFORMED ON A MULTILANE UNDIVIDED HIGHWAY. UNDER THESE CONDITIONS THE SIGNS NORMALLY MOUNTED IN THE MEDIAN SHALL BE OMITTED.
5. ALL SIGNS SHALL BE POST MOUNTED IF THE CLOSURE TIME EXCEEDS THREE DAYS.
6. REFLECTORIZED TEMPORARY PAVEMENT MARKING MAY BE OMITTED IF CLOSURE TIME IS LESS THAN THREE DAYS.
7. ALL VEHICLES, EQUIPMENT, WORKERS AND THEIR ACTIVITIES ARE RESTRICTED AT ALL TIMES TO ONE SIDE OF THE PAVEMENT UNLESS OTHERWISE AUTHORIZED BY THE ENGINEER.
8. WHEN ELECTRIC ARROW IS USED CARE MUST BE TAKEN TO INSURE 24 HOUR OPERATION. IT SHALL BE POSITIONED BEHIND THE CHANNELIZATION DEVICES AND SHALL NOT BE AN UNPROTECTED OBJECT TO THE MOTORIST. MINIMUM SIGHT DISTANCE SHALL BE 1000 FT.
9. FLASHING WARNING LIGHTS AND/OR FLAGS MAY BE USED TO CALL ATTENTION TO THE ABOVE WARNING SIGNS, AS NEEDED ON THE PLANS, AND/OR AS DIRECTED BY THE ENGINEER.

CASE F7

MULTILANE, DIVIDED OPERATION

WHERE AT ANY TIME ANY VEHICLE, EQUIPMENT, WORKERS OR THEIR ACTIVITIES WILL ENCROACH ON ANY PORTION OF THE LANE IMMEDIATELY ADJACENT TO THE ACCELERATION LANE.

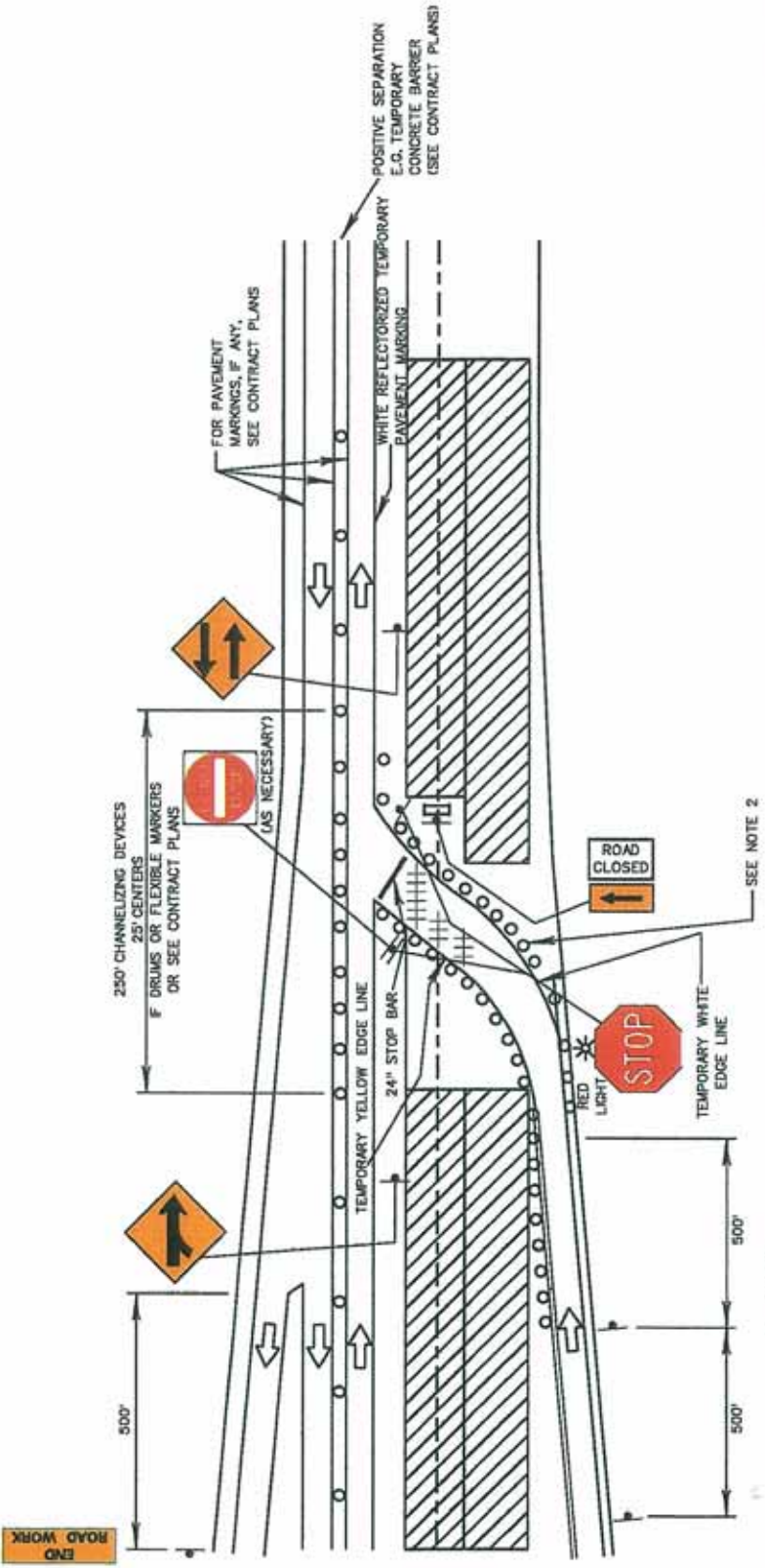

SUGGESTED ADVANCE WARNING SIGN SPACING

ROAD TYPE	DISTANCE BETWEEN SIGNS (IN FT)		
	A	B	C
URBAN (LOW SPEED)*	100	100	100
URBAN (HIGH SPEED)*	350	350	350
RURAL	500	500	500
EXPRESSWAY/FREEWAY	1000	1500	2,640

*SPEED CATEGORY TO BE DETERMINED BY WV DCH

GENERAL NOTES

1. ALL VEHICLES, EQUIPMENT, WORKERS AND THEIR ACTIVITIES ARE RESTRICTED AT ALL TIMES TO ONE SIDE OF THE PAVEMENT UNLESS OTHERWISE AUTHORIZED BY THE ENGINEER.
2. WHEN USED THE STOP OR YIELD SIGN SHOULD BE LOCATED SO THE RAMP VEHICULAR TRAFFIC HAS ADEQUATE SIGHT DISTANCE OF ONCOMING MAINLINE MOTOR VEHICLE TRAFFIC TO SELECT A SAFE GAP IN THE MAINLINE MOTOR VEHICLE TRAFFIC FLOW. IF INSUFFICIENT GAPS ARE AVAILABLE, CONSIDERATION SHOULD BE GIVEN TO CLOSING THE RAMP.
3. CONES OR DRUMS SHALL BE SPACED AT 10 FOOT ALONG THE LAST 100 FT. OF MAINLINE AND THE RAMP.
4. IS PREFERABLE TO DEVELOP AN ADEQUATE TEMPORARY ACCELERATION LANE AND THEN USE YIELD SIGN AND YIELD AHEAD SYMBOL SIGN.
5. FLASHING WARNING LIGHTS AND/OR FLAGS MAY BE USED TO CALL ATTENTION TO THE ABOVE WARNING SIGNS, AS NEEDED ON THE PLANS, AND/OR AS DIRECTED BY THE ENGINEER.

SYMBOLS

- WORK AREA
- SIGN
- TYPE III BARRICADES.
- SIGN ON PORTABLE OR PERMANENT SUPPORT.
- DRUM
- ERADICATION

CASE F8

MEDIAN CROSSOVER FOR ENTRANCE RAMP
MULTILANE, DIVIDED HIGHWAY, TRAFFIC ON
ONE SIDE (TWO-LANE, TWO-WAY)